

APPENDIX C
BMP Design Manual

Appendix C - BMP Design Manual





SAN DIEGO
INTERNATIONAL AIRPORT

LET'S GO.

San Diego County Regional Airport Authority BMP Design Manual For Permanent Site Design and Storm Water Treatment

February 2022

wood.

Prepared by:

Geosyntec
consultants

RICK
ENGINEERING COMPANY



project clean water

San Diego County Regional Airport Authority BMP Design Manual

The Airport Authority BMP Design Manual conforms significantly to the Model BMP Design Manual developed by the following San Diego Region Municipal Copermittees:

City of Carlsbad
www.carlsbadca.gov

City of Chula Vista
www.chulavistaca.gov

City of Coronado
www.coronado.ca.us

City of Del Mar
www.delmar.ca.us

City of El Cajon
www.ci.el-cajon.ca.us

City of Encinitas
www.ci.encinitas.ca.us

City of Escondido
www.ci.escondido.ca.us

City of Imperial Beach
www.imperialbeachca.gov

City of La Mesa
www.ci.la-mesa.ca.us

City of Lemon Grove
www.lemongrove.ca.gov

City of National City
www.ci.national-city.ca.us

City of Oceanside
www.ci.oceanside.ca.us

City of Poway
www.ci.poway.ca.us

City of San Diego
www.sandiego.gov

City of San Marcos
www.ci.san-marcos.ca.us

City of Santee
www.santech2o.org

City of Solana Beach
www.ci.solana-beach.ca.us

City of Vista
www.ci.vista.ca.us

County of San Diego
www.sandiegocounty.gov

San Diego Unified Port District
www.portofsandiego.org

San Diego County Regional Airport Authority
www.san.org

Summary

The San Diego County Regional Airport Authority (Authority) Best Management Practice (BMP) Design Manual (Manual) addresses post-construction urban runoff pollution from new development and redevelopment projects. This Manual provides airport tenants and Authority staff with information on how to comply with the urban runoff management requirements for development projects at the San Diego International Airport (SAN). This Manual guides the project manager or engineer through selection, design, and incorporation of storm water BMPs or storm water treatment control/management facilities into project design plans. This Manual also provides information on the Authority Alternative Compliance Program (ACP) regulating post-construction storm water discharges for offsite projects within the Authority’s jurisdiction.

In May 2013, the California Regional Water Quality Control Board for the San Diego Region (SDRWQCB) reissued a municipal storm water National Pollutant Discharge Elimination System (NPDES) permit (Municipal Separate Storm Sewer Systems [MS4] Permit) that covered its region. The San Diego Region comprises San Diego, Orange, and Riverside County Copermittees. The MS4 Permit (also referred to as the Municipal Permit) reissuance to the San Diego County Copermittees went into effect in 2013 (Order No. R9-2013-0001).

The reissued MS4 Permit updates and expands storm water requirements for new developments and redevelopments. In February 2015, the MS4 Permit was amended by Order No. R9-2015-0001, and again in November 2015 by Order No. R9-2015-0100. As required by the reissued MS4 Permit, the Copermittees prepared a Model BMP Design Manual to replace the current Countywide Model Standard Urban Stormwater Mitigation Plan (SUSMP), dated March 25, 2011, which was based on the requirements of the 2007 MS4 Permit. The effective date of that Manual was February 2016.

Each Copermittee was required to update the Model BMP Design Manual with jurisdiction-specific information. The initial February 2016 Manual represented the Authority’s update to the Authority SUSMP Requirements for Development Applications (Authority, 2011) to conform to the Model BMP Design Manual and comply with requirements of the MS4 Permit.

Following the adoption and implementation of the February 2016 Manual, the Copermittees prepared an updated version of the Manual. The updated Manual incorporates additional public comments, clarifications from the SDRWQCB, and additional BMP sizing, maintenance, and design guidance. A summary of the updates incorporated into the manual is provided in the table “Chronology of Storm Water Regulations and San Diego Region Model Guidance Documents” at the end of this section. This Manual replaces and supersedes the February 2016 Manual.

What This Manual is Intended to Address

This Manual addresses updated onsite post-construction storm water requirements for Standard Projects and Priority Development Projects (PDPs), and provides updated procedures for planning, preliminary design, selection, and design of permanent storm water BMPs based on the performance standards presented in the MS4 Permit.

The intended users of the Manual include project applicants for both Authority and tenant developments, their representatives responsible for preparation of Storm Water Quality Management Plans (SWQMPs), and Authority Planning and Environmental Affairs Department (P&EAD) personnel responsible for review of these plans.

The following are significant updates to storm water requirements of the MS4 Permit compared with the 2007 MS4 Permit and 2011 Countywide Model SUSMP:

- PDP categories have been updated, and the minimum threshold of impervious area to qualify as a PDP has been reduced.
- Many of the low-impact development (LID) requirements for site design that were applicable only to PDPs under the 2007 MS4 Permit are applicable to all projects (Standard Projects and PDPs) under the MS4 Permit.
- The standard for storm water pollutant control (formerly treatment control) is retention of the 24-hour, 85th percentile storm volume, defined as the event that has a precipitation total greater than or equal to 85 percent of all daily storm events larger than 0.01 inch over a given period of record in a specific area or location.
- For situations in which onsite retention of the 85th percentile storm volume is technically not feasible, biofiltration must be provided to satisfy specific “biofiltration standards.” These standards consist of a set of siting, selection, sizing, design, and operation and maintenance (O&M) criteria that must be met for a BMP to be considered a “biofiltration BMP” – see Section 2.2.1 and Appendix F. Offsite alternative compliance approaches are provided as an option to satisfy pollutant control standards if a Copermittee implements an ACP. Copermittees are given discretion by the MS4 Permit to allow the project applicants to participate in an ACP without demonstrating technical infeasibility of retention and/or biofiltration BMPs onsite.

What This Manual Does Not Address

This Manual does not directly discuss the requirements of the NPDES General Permit for Storm Water Discharges Associated with Construction and Land Disturbance Activities (Order No. 2009-0009-DWQ, as amended by Order Nos. 2010-0014-DWQ and 2012-0006-DWQ) (the Construction General Permit [CGP]). These requirements are provided in Section 5 of the Authority’s Storm Water Management Plan (SWMP), available for download at www.san.org/green. This Manual is not intended to serve as a guidance or criteria document for construction-phase storm water controls. This Manual does not substantially address hydromodification management requirements or protection of critical coarse sediment yield areas, because drainages from the Authority’s jurisdiction are exempt from hydromodification management requirements. Section 1.6 provides further details of this exemption. Additionally, this Manual is not intended to serve as a Green Streets design manual.

Disclaimer

Currently, some of the Copermittees are pursuing a subvention of funds from the State of California (State) to pay for certain activities required by the 2007 MS4 Permit, including activities that require Copermittees to perform activities outside their jurisdictional boundaries and on a regional or watershed basis. Nothing in this Manual should be viewed as a waiver of those claims or as a waiver of the rights of Copermittees to pursue a subvention of funds from the State to pay for certain activities required by the MS4 Permit, including the preparation and implementation of the BMP

Design Manual. In addition, several Copermittees have filed petitions with the California State Water Quality Control Board (State Board) challenging some of the requirements of Provision E of the MS4 Permit. Nothing in this Manual should be viewed as a waiver of those claims. Because the State Board has not issued a stay of the 2013 MS4 Permit, Copermittees must comply with MS4 Permit requirements while the State Board process is pending.

This Manual is Organized in the Following Manner

An introductory section titled **“How to Use this Manual”** provides a practical orientation to intended uses and provides examples of recommended workflows for using the Manual.

Chapter 1 provides information to help the Manual user determine the storm water management requirements that are applicable to the project, and addresses source controls (SCs)/site design (SD) and pollutant controls. This chapter also introduces the procedural requirements for preparation, review, and approval of project submittals. General Authority requirements for processing project submittals are provided in this chapter.

Chapter 2 defines the performance standards for source control and site design BMPs and storm water pollutant control BMPs, based on the MS4 Permit. These are the underlying criteria that must be met by projects, as applicable. Hydromodification management BMPs do not apply to Authority projects because of the MS4 Permit exemption for projects that discharge runoff to existing underground storm drains discharging directly to an enclosed embayment (MS4 Permit Provision E.3.c(2)(d)(ii)). This chapter also presents information on the underlying concepts associated with these performance standards to provide the project applicant with technical background; explains why the performance standards are important; and provides a general description of how the performance standards can be met.

Chapter 3 describes the essential steps in preparing a comprehensive storm water management design and explains the importance of starting the process early during the preliminary design phase. By following the recommended procedures in Chapter 3, project applicants can develop a design that complies with the complex and overlapping storm water requirements. This chapter is intended to be used by both Standard Projects and PDPs; however, certain steps will not apply to Standard Projects (as identified in the chapter).

Chapter 4 presents the source control and site design requirements to be met by all development projects and is therefore intended to be used by Standard Projects and PDPs.

Chapter 5 applies to PDPs. It presents the specific process for determining which category of onsite pollutant control BMP, or combination of BMPs, is most appropriate for the PDP site and how to design the BMP to meet the storm water pollutant control performance standard. The prioritization order of onsite pollutant control BMPs begins with retention, then biofiltration, and finally flow-through treatment control (in combination with offsite alternative compliance). Chapter 5 does not apply to Standard Projects.

Chapter 6 applies to PDPs that are subject to hydromodification management requirements. No Authority Standard Projects or PDPs are subject to hydromodification management requirements. As such, this section is significantly abbreviated from the Model BMP Design Manual.

Chapter 7 addresses the long-term O&M requirements of structural BMPs presented in this Manual and the mechanisms to ensure O&M in perpetuity. Chapter 7 also addresses Authority-specific O&M requirements. Chapter 7 applies to PDPs only and is not required for Standard Projects; however, Standard Projects may use this chapter as a reference.

Chapter 8 describes the specific requirements for the content of project submittals to facilitate the Authority’s review of project plans for compliance with applicable requirements of the Manual and the MS4 Permit. This chapter is applicable to Standard Projects and PDPs. This chapter pertains specifically to the content of project submittals and not to specific details of Authority requirements for processing of submittals; it is intended to complement the requirements for processing of project submittals that are included in Chapter 1, and as described in Section 4 of the SWMP.

Appendices to this Manual provide detailed guidance for BMP design, calculation procedures, worksheets, maps, and other figures to be referenced for BMP design. These appendices are not intended to be used independently from the overall Manual – rather they are intended to be used only as referenced in the main body of the Manual.

This Manual is organized based on project category. Requirements that are applicable to both Standard Projects and PDPs are presented in Chapter 4. Additional requirements applicable only to PDPs are presented in Chapters 5 through 7. Although source control and site design BMPs are required for all projects, including Standard Projects and PDPs, structural BMPs are required only for PDPs. Throughout this Manual, “structural BMP” refers to a pollutant control BMP.

Chronology of Storm Water Regulations and San Diego Region Model Guidance Documents

Date	Document	Notes
July 16, 1990	MS4 Permit	The SDRWQCB issued general storm water requirements to all jurisdictions within the County of San Diego via the MS4 Permit
February 21, 2001	MS4 Permit	Land development SUSMP requirements were written into the MS4 Permit during permit reissuance
February 14, 2002	Model SUSMP	A countywide model guidance document was issued for implementation of the 2001 MS4 Permit requirements
January 24, 2007	MS4 Permit	LID and hydromodification management plan (HMP) requirements were written into the MS4 Permit during reissuance
July 24, 2008	Model SUSMP	A countywide model guidance document for implementation of the 2007 MS4 Permit requirements, including interim HMP criteria, was prepared
March 2011	Final HMP	The final HMP addressed HMP requirements of the 2007 MS4 Permit
March 25, 2011	Model SUSMP	A countywide model guidance document for implementation of the 2007 MS4 Permit requirements, including final HMP, was completed
May 8, 2013	MS4 Permit	Storm water retention requirements and requirements for protection of critical coarse sediment yield were written into the MS4 Permit during reissuance
February 11, 2015	MS4 Permit	The 2013 MS4 Permit was amended to provide clarification on water quality equivalency and provide other technical revisions Permit coverage was extended to Orange County Copermittees

Chronology of Storm Water Regulations and San Diego Region Model Guidance Documents (continued)

Date	Document	Notes
June 27, 2015	Model BMP Design Manual	A countywide model guidance document for implementation of the MS4 Permit requirements was prepared The "Model BMP Design Manual" updated the former "Model SUSMP"
November 18, 2015	MS4 Permit	The 2013 MS4 Permit was amended to provide clarification on Prior Lawful Approval requirements Permit coverage was extended to Riverside County Copermittees
December 17, 2015	Water Quality Equivalency Guidelines	The Draft Water Quality Equivalency Guidelines (WQE) was accepted by the SDRWQCB The WQE provided the basis for determining approval of Alternative Compliance projects
February 16, 2016	Model BMP Design Manual	The June 2015 version was updated, including PDP and redevelopment definitions, storm water requirements applicability timeline, and hydromodification management performance criteria and procedures
May 2018	Water Quality Equivalency Guidelines	On March 15, 2019, the San SDRWQCB accepted an updated version of the WQE Guidance Document for Region 9 Additional available resources are the Automated WQE Worksheet, ArcGIS shapefiles, and presentation slides
May 30, 2018	Model BMP Design Manual	The February 2016 version was updated, including guidance regarding geotechnical feasibility, biofiltration BMP sizing, hydromodification sizing factors, and operations and maintenance requirements Updates to Appendices included addition of source control fact sheets and bioretention soil media (BSM) specifications

This page intentionally left blank

Table of Contents

Summary i

List of Acronyms and Abbreviations xiii

How to Use This Manual xv

1. POLICIES AND PROCEDURAL REQUIREMENTS 1

1.1 INTRODUCTION TO STORM WATER MANAGEMENT POLICIES 1

1.2 PURPOSE AND USE OF THE MANUAL 2

 1.2.1 Determining Applicability of Permanent BMP Requirements 4

 1.2.2 Determine Applicability of Construction BMP Requirements 4

1.3 DEFINING A PROJECT 4

1.4 IS THE PROJECT A PDP? 6

 1.4.1 PDP Categories 6

 1.4.2 Local Additional PDP Categories and/or Expanded PDP Definitions 9

 1.4.3 Local PDP Exemptions or Alternative PDP Requirements 9

1.5 DETERMINING APPLICABLE STORM WATER MANAGEMENT REQUIREMENTS 9

1.6 APPLICABILITY OF HYDROMODIFICATION MANAGEMENT REQUIREMENTS 10

1.7 SPECIAL CONSIDERATIONS FOR REDEVELOPMENT PROJECTS (50% RULE) 11

1.8 ALTERNATIVE COMPLIANCE PROGRAM 12

1.9 RELATIONSHIP BETWEEN THIS MANUAL AND WATER QUALITY IMPROVEMENT PLANS 14

1.10 PROJECT REVIEW PROCEDURES 15

1.11 PDP STRUCTURAL BMP VERIFICATION 16

2. PERFORMANCE STANDARDS AND CONCEPTS 19

2.1 SOURCE CONTROL AND SITE DESIGN REQUIREMENTS FOR ALL DEVELOPMENT PROJECTS 19

 2.1.1 Performance Standards 19

 2.1.2 Concepts and References 21

2.2 STORM WATER POLLUTANT CONTROL REQUIREMENTS FOR PDPs 23

 2.2.1 Storm Water Pollutant Control Performance Standard 23

 2.2.2 Concepts and References 24

2.3 HYDROMODIFICATION MANAGEMENT REQUIREMENTS FOR PDPs 28

 2.3.1 Hydromodification Management Performance Standards 28

2.4 RELATIONSHIP AMONG PERFORMANCE STANDARDS 28

3. DEVELOPMENT PROJECT PLANNING AND DESIGN 31

3.1 COORDINATION AMONG DISCIPLINES..... 32

3.2 GATHERING PROJECT SITE INFORMATION 33

3.3 DEVELOPING CONCEPTUAL SITE LAYOUT AND STORM WATER CONTROL STRATEGIES..... 34

 3.3.1 Preliminary Design Steps for All Development Projects 34

 3.3.2 Evaluation of Critical Coarse Sediment Yield Areas..... 35

 3.3.3 Drainage Management Areas 35

 3.3.4 Developing Conceptual Storm Water Control Strategies 38

3.4 DEVELOPING COMPLETE STORM WATER MANAGEMENT DESIGN 39

 3.4.1 Steps for All Development Projects..... 40

 3.4.2 Steps for PDPs With Only Pollutant Control Requirements 40

 3.4.3 Steps for Projects With Pollutant Control and Hydromodification Management Requirements 41

3.5 PROJECT PLANNING AND DESIGN REQUIREMENTS SPECIFIC TO THE AUTHORITY..... 41

3.6 PHASED PROJECTS..... 41

4. SOURCE CONTROL AND SITE DESIGN REQUIREMENTS FOR ALL DEVELOPMENT PROJECTS 43

4.1 GENERAL REQUIREMENTS (GRS)..... 43

4.2 SOURCE CONTROL (SC) BMP REQUIREMENTS 44

4.3 SITE DESIGN (SD) BMP REQUIREMENTS..... 47

5. STORM WATER POLLUTANT CONTROL REQUIREMENTS FOR PDPS..... 57

5.1 STEPS FOR SELECTING AND DESIGNING STORM WATER POLLUTANT CONTROL BMPs 57

5.2 DMAS EXCLUDED FROM DCV CALCULATION..... 61

 5.2.1 Self-mitigating DMAs 61

 5.2.2 *De Minimis* DMAs 62

 5.2.3 Self-retaining DMAs via Qualifying Site Design BMPs 62

5.3 DCV REDUCTION THROUGH SITE DESIGN BMPs 64

5.4 EVALUATING FEASIBILITY OF STORM WATER POLLUTANT CONTROL BMP OPTIONS 65

 5.4.1 Feasibility Screening for Harvest and Use Category BMPs 65

 5.4.2 Feasibility Screening for Infiltration Category BMPs 65

5.5 BMP SELECTION AND DESIGN 68

 5.5.1 Retention Category..... 69

 5.5.2 Partial Retention BMP Category..... 71

 5.5.3 Biofiltration BMP Category 72

 5.5.4 Flow-through Treatment Control BMPs (for Use with Alternative Compliance) Category 73

5.5.5 Alternative BMPs 74

6. HYDROMODIFICATION MANAGEMENT REQUIREMENTS FOR PDPS 75

7. LONG TERM OPERATION AND MAINTENANCE..... 77

7.1 NEED FOR PERMANENT INSPECTION AND MAINTENANCE 77

7.1.1 MS4 Permit Requirements 77

7.1.2 Practical Considerations 77

7.2 SUMMARY OF STEPS TO MAINTENANCE AGREEMENT 78

7.3 MAINTENANCE RESPONSIBILITY 79

7.4 LONG-TERM MAINTENANCE DOCUMENTATION..... 80

7.5 INSPECTION AND MAINTENANCE FREQUENCY 80

7.6 MEASURES TO CONTROL MAINTENANCE COSTS 81

7.7 MAINTENANCE INDICATORS AND ACTIONS FOR STRUCTURAL BMPs 83

7.7.1 Maintenance of Vegetated Infiltration or Filtration BMPs..... 83

7.7.2 Maintenance of Non-Vegetated Infiltration BMPs 84

7.7.3 Maintenance of Non-Vegetated Filtration BMPs..... 85

7.7.4 Maintenance of Detention BMPs 86

8. SUBMITTAL REQUIREMENTS..... 87

8.1 SUBMITTAL REQUIREMENT FOR STANDARD PROJECTS 87

8.1.1 Standard Project SWQMP 87

8.2 SUBMITTAL REQUIREMENTS FOR PDPS..... 88

8.2.1 PDP SWQMP 88

8.2.2 Requirements for Construction Plans..... 89

8.2.3 Design Changes During Construction and Project Closeout Procedures..... 90

8.2.4 Additional Requirements for Tenant O&M 91

9. BIBLIOGRAPHY..... 93

Appendices

- APPENDIX A: Airport Authority Data and SWQMP Templates
- APPENDIX B: Storm Water Pollutant Control Hydrologic Calculations and Sizing Methods
- APPENDIX C: Geotechnical and Groundwater Investigation Requirements
- APPENDIX D: Approved Infiltration Rate Assessment Methods for Selection and Design of Storm Water BMPs
- APPENDIX E: BMP Design Fact Sheets
- APPENDIX F: Biofiltration Standard and Checklist
- APPENDIX G: Guidance for Continuous Simulation and Hydromodification Management Sizing Factors
- APPENDIX H: Forms and Checklists
- APPENDIX I: USEPA Green Streets Handbook
- APPENDIX J: Alternative Compliance Program
- Glossary of Key Terms

Figures

FIGURE 1-1. Procedural Requirements for a Project to Identify Storm Water Requirements.....	3
FIGURE 3-1. Approach for Developing a Comprehensive Storm Water Management Design ...	31
FIGURE 3-2. DMA Delineation.....	36
FIGURE 3-3. Tributary Area for BMP Sizing	37
FIGURE 5-1. Storm Water Pollutant Control BMP Selection Flow Chart.....	58
FIGURE 5-2. Storm Water Pollutant Control BMP Selection Flow Chart.....	59
FIGURE 5-3. Self Mitigating Area.....	62
FIGURE 5-4. Self-retaining DMA Site	64
FIGURE 5-5. Infiltration Feasibility and Desirability Screening Flow Chart.....	67
FIGURE 5-6. Schematic of a Typical Cistern	69
FIGURE 5-7. Schematic of a Typical Infiltration Basin	70
FIGURE 5-8. Schematic of a Typical Biofiltration with Partial Retention BMP	71
FIGURE 5-9. Schematic of a Typical Biofiltration Basin.....	72
FIGURE 5-10. Schematic of a Vegetated Swale.....	74

Tables

TABLE 1-1. Checklist for a Project to Identify Applicable Post-Construction Storm Water Requirements	4
TABLE 1-2. Applicability of Permanent, Post-Construction Storm Water Requirements	6
TABLE 1-3. Applicability of Manual Sections for Different Project Types.....	10
TABLE 3-1. Applicability of Section 3.3 Subsections for Different Project Types.....	34
TABLE 3-2. Applicability of Section 3.4 Subsections for Different Project Types.....	40
TABLE 5-1. Permanent Structural BMPs for PDPs.....	68
TABLE 7-1. Schedule for Developing O&M Plan and Agreement	78
TABLE 7-2. Maintenance Indicators and Actions for Vegetated BMPs	84
TABLE 7-3. Maintenance Indicators and Actions for Non-Vegetated Infiltration BMPs.....	85
TABLE 7-4. Maintenance Indicators and Actions for Filtration BMPs.....	86
TABLE 7-5. Maintenance Indicators and Actions for Detention BMPs.....	86
TABLE 8-1. Format for Construction Plans SWQMP Checklist	90

This page intentionally left blank

List of Acronyms and Abbreviations

303(d)	Refers to Clean Water Act Section 303(d) list of impaired and threatened waters
ACP	Alternative Compliance Project
ADC	San Diego County Regional Airport Authority Airport Design and Construction
Authority	San Diego County Regional Airport Authority
BF	biofiltration (BMP Category)
BMP	best management practice
Caltrans	California Department of Transportation
CGP	Construction General Permit
CIC	Airport Capital Improvement Committee
CEQA	California Environmental Quality Act
DCV	design capture volume
DMA	drainage management area
EIR	Environmental Impact Report
ESA	Environmentally Sensitive Area
FAA	Federal Aviation Administration
FMD	Facilities Management Department
Framework	Water Quality Equivalency Credit Trading Framework
FT	flow through (BMP Category)
ft³	cubic foot (feet)
GR	general requirement
HMP	Hydromodification Management Plan
HSPF	Hydrologic Simulation Program-FORTRAN
HU	harvest and use (BMP Category)
HVAC	heating, ventilation, and air conditioning
INF	infiltration (BMP Category)
LEED	Leadership in Energy and Environmental Design
LID	low-impact development
Manual	Authority BMP Design Manual
MEP	maximum extent practicable
MS4	Municipal Separate Storm Sewer System
MS4 Permit	National Pollutant Discharge Elimination System (NPDES) Permit and Waste Discharge Requirements for Discharges from the MS4s Draining the Watersheds Within the San Diego Region” (Order No. R9-2013-0001, as amended by Order Nos. R9-2015-0001 and R9-2015-0100)
NPDES	National Pollutant Discharge Elimination System
O&M	Operation and Maintenance
P&EAD	San Diego County Regional Airport Authority Planning and Environmental Affairs Department
PDP	Priority Development Project
PL	plant list

List of Acronyms and Abbreviations (continued)

PR	partial retention (BMP Category)
RARE	Rare, Threatened, or Endangered Species beneficial use
SAN	San Diego International Airport
SC	source control (BMP Category)
SCCWRP	Southern California Coastal Water Research Project
SD	site design (BMP Category)
SDHM	San Diego Hydrology Model
SDRWQCB	California Regional Water Quality Control Board, San Diego Region
SIC	Standard Industrial Classification
State	State of California
State Board	California State Water Quality Control Board
SUSMP	Standard Urban Stormwater Mitigation Plan
SWMM	Storm Water Management Model
SWMP	Storm Water Management Plan
SWQMP	Storm Water Quality Management Plan
TMDL	total maximum daily load
UIC	underground injection control
U.S.	United States
USEPA	United States Environmental Protection Agency
WMAA	Watershed Management Area Analysis
WQE	Water Quality Equivalency
WQP Guidance Document	2018 WQE Guidance Document for Region 9
WQIP	Water Quality Improvement Plan

How to Use This Manual

This Manual is intended to help a project applicant/proponent, in coordination with Airport Authority P&EAD staff, develop an SWQMP for a development project that complies with local and MS4 Permit requirements. Most applicants will require the assistance of a qualified civil engineer, architect, and/or landscape architect to prepare an SWQMP. The applicant should begin by checking specific requirements with P&EAD storm water program staff, because every project is different.

As described in the Authority's SWMP, the Authority is a special government entity, created in 2003 by the California legislature and granted responsibility for managing SAN. Several tenants and subtenants operate businesses at SAN under the Authority's jurisdiction. In addition, the Authority operates its own "municipal" facilities, including the terminals, parking lots, and other support buildings.

Article 8 of the Authority Code, referred to as the Storm Water Code, consists of its storm water management and discharge controls. Section 8.74(a)(3) addresses New Development and Redevelopment and states that "the Executive Director may establish controls on the volume and rate of storm water runoff from new developments and redevelopments as may be reasonably necessary to minimize the discharge and transport of pollutants." The Manual represents one mechanism by which the Executive Director has established such controls to comply with the MS4 Permit.

New development and redevelopment projects are conducted by two major categories of project proponents: projects conducted by tenants of the airport (referred to as "tenant projects") and projects conducted by the Authority itself (referred to as "capital projects"). The Authority has a different project approval process for each of these project proponent categories, and these differences are reflected in the Manual project review and approval processes. The Manual approval process, including roles and responsibilities of Authority departments, is described below for both tenant and capital projects.

Tenant Projects

Whenever an airport tenant desires to make surface or subsurface improvements or perform new construction, reconstruction, modification, or demolition, the tenant must submit a request for approval to the Airside and Terminal Operations Department prior to commencing work. The request must be accompanied by plans and specifications that indicate the nature and extent of the proposed work and must conform to Authority policies and all relevant laws, ordinances, rules, and regulations. The plans may include references to specific sections or parts of the Uniform Building Code or other applicable codes, ordinances, or laws. The Airside and Terminal Operations Department, in conjunction with the Airport Design and Construction (ADC) Department, assigns a project manager to evaluate the project application for completeness and to coordinate technical review with the other Authority departments. P&EAD must determine whether the current Manual requirements are applicable to the project, as described in Section 1.2. For both Standard Projects and PDPs, for the project application to be considered complete, the project proponent must submit a SWQMP with the project application in accordance with the Manual describing how the project will meet the Manual requirements. P&EAD reviews the finalized project plans and documents to ensure that all environmental requirements are met.

The approval of a SAN tenant project becomes part of the lease or part of a use and occupancy permit once all documents in the project application have been approved. Any California Environmental Quality Act (CEQA) mitigation measures or conditions of approval required by the review process of these departments become part of the lease or use permit and may be adopted by the Airport Authority Board (Board) as a CEQA Mitigation Monitoring and Reporting Program. Sustainability and Leadership in Energy and Environmental Design (LEED) criteria commitments are also incorporated. Written approval must be obtained from the Authority before development may begin, regardless of the scope of work.

Capital Projects

Development projects at the airport that are carried out by the Authority itself are considered Capital Projects or Major Maintenance Projects.

Whenever an Authority department desires to make surface or subsurface improvements or to perform new construction, reconstruction, modification, or demolition, the project sponsor, proponent, or manager must submit appropriate information to the Authority's Capital Improvements Committee (CIC). The CIC evaluates each development project based on its financial funding and capacity, and prepares a development program with the accepted projects. P&EAD assesses the environmental impacts of the program. P&EAD must determine whether the current Manual requirements are applicable to the project, as described in Section 1.2. For both Standard Projects and PDPs, for the project submittal to be considered complete, the submittal must include an SWQMP in accordance with the Manual describing how the project will meet the Manual requirements. Once reviewed by the relevant Authority departments, the development program is submitted to the Board for approval. The Board evaluates the development program and determines whether the program will be included as part of the Authority's budget. Any mitigation measures or conditions of approval required by the review process of these departments become part of the project design, contract, and/or implementation and are formalized, as necessary, as a CEQA Mitigation Monitoring and Reporting Program adopted by the Board at the time of project approval. Again, commitments to sustainability or LEED initiatives are also incorporated into the project design and contracts.

Departmental Responsibilities

The general responsibilities of those departments involved in the implementation of the Authority's process to implement the Manual are listed in the following table. The inspectors of ADC ensure that structural BMPs are installed according to approved plans. The Business & Financial Management Department and P&EAD are responsible for ensuring that tenants properly operate and maintain any storm water pollution control measures that were required as part of the project approval. The P&EAD, Facilities Management Department (FMD), and the Airside and Terminal Operations Department staffs are involved with the operation and proper maintenance of BMPs installed for capital projects and major maintenance projects.

Department	Education	Tenant Project Review	Tenant Project Approval	Capital Project Planning	Capital Project Review	Capital Project Approval	Construction Inspection	Capital Project Operations and Maintenance	Enforcement
Airport Board						X			
Aviation Security and Public Safety	O						O	X	O
Airport Design and Construction (ADC)	O	X	X	X	X	X	X		
Business and Financial Management Department	X	X	X				O		X
Capital Improvements Committee (CIC)				X					
Facilities Maintenance Department (FMD)	O							X	
Planning and Environmental Affairs Department (P&EAD)	X	X	X	O	X	X	O	O	X
Airside and Terminal Operations Department	O						O	X	O
X – Primary Responsibility O – Secondary Responsibility									

Adequacy of Proposed Plans

P&EAD reviews SWQMP documents and other relevant plans for compliance with the applicable Manual requirements. P&EAD may approve proposed alternatives to the BMP requirements in the Manual if they are determined to be applicable and equally effective. Additional analysis or information may be required to enable staff to determine the adequacy of proposed BMPs and are requested

following the conclusion of a staff review cycle. The SWQMP is deemed complete once P&EAD determines that the project’s compliance with the Manual is adequately described in the SWQMP and related plans.

Beginning Steps for All Projects: What Requirements Apply?

To use this Manual, start by reviewing **Chapter 1** to determine whether your project is a “Standard Project” or a “PDP” (refer also to local requirements) and which storm water quality requirements apply to your project.

Not all requirements and processes described in this Manual apply to all projects. Therefore, it is important to begin with a careful analysis of the requirements that apply to Authority projects. Chapter 1 also provides an overview of the process of planning, design, construction, operation, and maintenance, with associated Authority review and approval steps, leading to compliance. The following flow chart shows how to categorize a project in terms of applicable post-construction storm water requirements. The flow chart is followed by a table that lists the applicable section of this Manual for each project type.

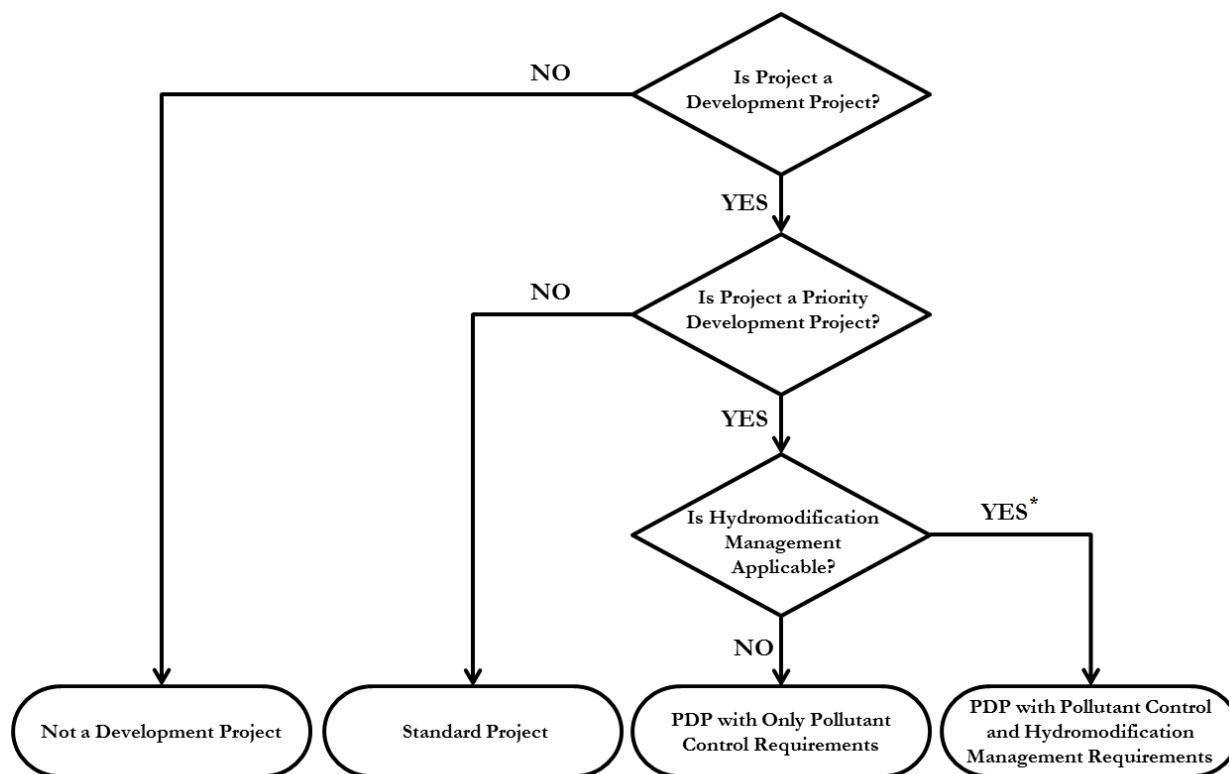

*Note: Hydromodification management requirements do not apply to Authority projects.

Project Type	Applicable Requirements		
	Source Control and Site Design (Chapter 4)	Storm Water Pollutant Control BMPs (Chapter 5)	Hydromodification Management BMPs (Chapter 6)
Not a Development Project (without impact on storm water quality or quantity – e.g., interior remodels, routine maintenance; refer to Section 1.3)	Requirements in this Manual do not apply		
Standard Projects	X		
PDPs With Only Pollutant Control Requirements	X	X	
PDPs With Pollutant Control and Hydromodification Management Requirements	Requirements do not apply to Authority projects		

Once an applicant has determined the applicable requirements, **Chapter 2** describes the specific performance standards associated with each requirement. For example, an applicant may learn from Chapter 1 that the project must meet storm water pollutant control requirements. Chapter 2 describes these requirements. This chapter also provides background on key storm water concepts to help understand why these requirements are in place and how they can be met. Refer to the list of acronyms and glossary as guidance for understanding the meaning of key terms within the context of this Manual.

Next Steps for All Projects: How Should an Applicant Approach a Project Storm Water Management Design?

Applicants for most projects then proceed to **Chapter 3** for step-by-step guidance to prepare a storm water project submittal for the site. This chapter does not specify any regulatory criteria beyond those already specified in Chapters 1 and 2 – rather it is intended to serve as a resource for project applicants to help navigate the task of developing a compliant storm water project submittal. Note that the first steps in Chapter 3 apply to both Standard Projects and PDPs; other steps in Chapter 3 apply only to PDPs.

A step-by-step approach is highly recommended because it helps ensure that the right information is collected, analyzed, and incorporated into project plans, and the plans are submitted at the appropriate time in the Authority review process. It also helps facilitate a common framework for discussion between the applicant and the reviewer. However, each project is different, and it may be appropriate to use a different approach if the applicant demonstrates compliance with the MS4 Permit requirements that apply to the project.

Final Steps in Using This Manual: How Should an Applicant Design BMPs and Prepare Documents for Compliance?

Standard Projects	PDPs
<p>Standard Projects proceed to Chapter 4 for guidance on implementing source control and site design requirements.</p> <p>After Chapter 4, Standard Projects proceed to Chapter 8 for project submittal requirements.</p>	<p>PDPs also proceed to Chapter 4 for guidance on implementing source control and site design requirements.</p> <p>PDPs use Chapters 5 through 7 and associated appendices to implement pollutant control requirements (hydromodification management controls are not required) for the project site, as applicable. These projects proceed to Chapter 8 for project submittal requirements.</p>

Plan Ahead to Avoid Common Mistakes

The following common errors made by applicants delay or compromise development approvals with respect to storm water compliance:

- Not planning for compliance early enough. The strategy for storm water quality compliance should be considered before completing a conceptual site design or sketching a layout of project site or subdivision lots (see Chapter 3). Planning early is crucial under current requirements compared with previous requirements; for example, LID/site design is required for all development projects, and onsite retention of storm water runoff is required for PDPs. Additionally, collection of necessary information early in the planning process (e.g., geotechnical conditions, groundwater conditions) can help avoid delays resulting from redesign.
- Assuming that proprietary storm water treatment facilities are adequate for compliance and/or relying on strategies acceptable under previous MS4 Permits. Under the MS4 Permit, the standard for pollutant control for PDPs is **retention of the 85th percentile storm volume** (see Chapter 5). Flow-through treatment cannot be used to satisfy permit requirements unless the project also participates in an ACP. Under some conditions, certain proprietary BMPs may be classified as “biofiltration” according to Appendix F and can be used for primary compliance with storm water pollutant treatment requirements (i.e., without alternative compliance).
- Not planning for ongoing inspections and maintenance of PDP structural BMPs in perpetuity. It is essential to secure a mechanism for funding of long-term O&M of structural BMPs, select structural BMPs that can be effectively operated and maintained by the ultimate property owner, and include design measures to ensure access for maintenance and to control maintenance costs (see Chapter 7).

Policies and Procedural Requirements

This chapter of the Manual introduces storm water management policies and is intended to help categorize a project and determine the applicable storm water management requirements and options for compliance. This chapter also introduces the procedural requirements for preparation, review, and approval of project submittals.

1.1 Introduction to Storm Water Management Policies

MS4 Permit Provision E.3.a-c; E.3.d.(1)

Storm water management requirements for development projects are derived from the MS4 Permit and are implemented by local jurisdictions.

On May 8, 2013, the SDRWQCB reissued a municipal storm water permit titled “National Pollutant Discharge Elimination System (NPDES) Permit and Waste Discharge Requirements for Discharges from the MS4s Draining the Watersheds Within the San Diego Region” (Order No. R9-2013-0001, as amended by Order Nos. R9-2015-0001 and R9-2015-0100; referred to as MS4 Permit) to the municipal Copermittees. The MS4 Permit was issued by the SDRWQCB pursuant to section 402 of the federal Clean Water Act and implementing regulations (Code of Federal Regulations Title 40, Part 122) adopted by the United States Environmental Protection Agency (USEPA) and Chapter 5.5, Division 7 of the California Water Code. The MS4 Permit, in part, requires each Copermittee, including the Authority, to use its land use and planning authority to implement a development planning program to control and reduce the discharge of pollutants in storm water from new development and significant redevelopment to the maximum extent practicable (MEP). MEP is defined in the MS4 Permit.

Different requirements apply to different project types.

The MS4 Permit requires all development projects to implement source control and site design practices to minimize the generation of pollutants. Although all development projects are required to implement source control and site design/LID practices, the MS4 Permit has additional requirements for development projects that exceed size thresholds and/or fit under specific use categories. These projects, referred to as PDPs, are required to incorporate structural BMPs into the project plan to reduce the discharge of pollutants, and for those jurisdictions where it applies, address potential

hydromodification impacts from changes in flow and sediment supply. The Authority is exempt from hydromodification requirements.

1.2 Purpose and Use of the Manual

This Manual presents a “unified BMP design approach.”

To assist the land development community, streamline project reviews, and maximize cost-effective environmental benefits, the regional Copermittees have developed a unified BMP design approach¹ that meets the performance standards specified in the MS4 Permit. By following the process outlined in this Manual, project applicants (for both capital and tenant developments) can develop a single integrated design that complies with the complex and overlapping MS4 Permit source control and site design requirements, and storm water pollutant control requirements (i.e., water quality). Figure 1-1 presents a flow chart of the decision process that the Manual user should use to:

- 1) Categorize a project;
- 2) Determine storm water requirements; and
- 3) Understand how to submit projects for review and verification.

This figure also indicates where specific procedural steps associated with this process are addressed in Chapter 1.

Alternative BMP design approaches that meet applicable performance standards may also be acceptable.

Applicants may choose not to use the unified BMP design approach present in this Manual; in this case, they need to demonstrate to the satisfaction of the Authority, in their submittal, compliance with applicable performance standards. These performance standards are described in **Chapter 2** and in Section E.3.c of the MS4 Permit.

¹ The term “unified BMP design approach” refers to the standardized process for site and watershed investigation, BMP selection, BMP sizing, and BMP design that is outlined and described in this Manual with associated appendices and templates. This approach is considered to be “unified” because it represents a pathway for compliance with the MS4 Permit requirements that is anticipated to be reasonably consistent across the local jurisdictions in San Diego County. In contrast, applicants may choose to take an alternative approach where they demonstrate to the satisfaction of the Authority, in their submittal, compliance with applicable performance standards without necessarily following the process identified in this manual.

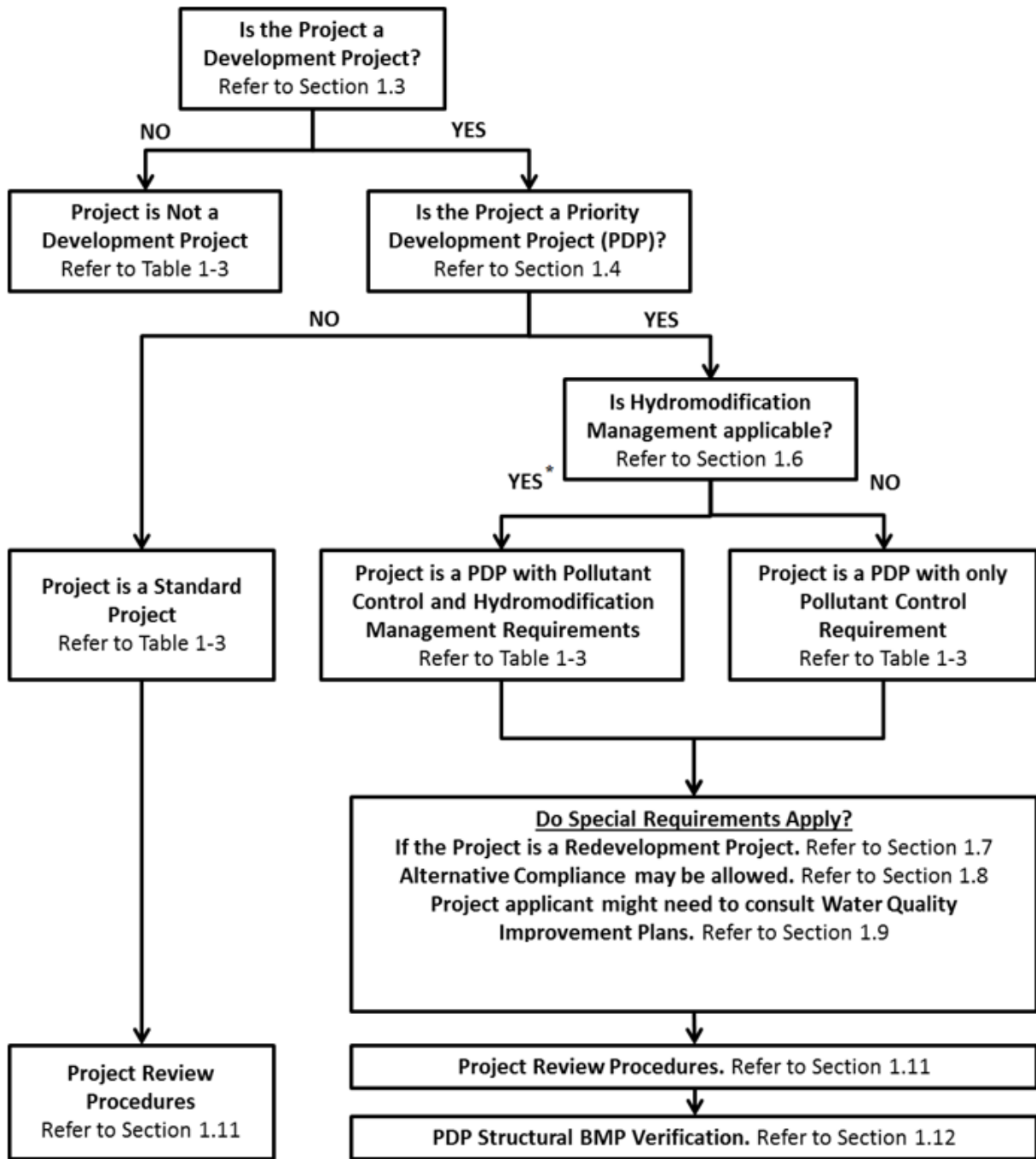

* Note: Hydromodification management requirements do not apply to Authority projects.

FIGURE 1-1. Procedural Requirements for a Project to Identify Storm Water Requirements

1.2.1 Determining Applicability of Permanent BMP Requirements

Table 1-1 reiterates the procedural requirements indicated in Figure 1-1 in a stepwise checklist format. The purpose of Table 1-1 is to guide applicants to appropriate sections in Chapter 1 to identify the post-construction storm water requirements applicable for a project. Table 1-1 is **not** intended to be used as a project intake form. An applicability checklist of permanent, post-construction storm water BMP requirements that may be used as a project intake form is provided in Appendix A.

TABLE 1-1. Checklist for a Project to Identify Applicable Post-Construction Storm Water Requirements

<p>Step 1. Is the project a Development Project? See Section 1.3 for guidance. A phase of a project can also be categorized as a development project. If “Yes” then continue to Step 2. If “No” then stop here; Permanent BMP requirements do not apply, i.e., requirements in this Manual are not applicable to the project.</p>	<p><input type="checkbox"/> Yes <input type="checkbox"/> No</p>
<p>Step 2. Is the project a PDP?</p>	
<p>Step 2a. Does the project fit one of the PDP definitions a–f? See Section 1.4.1 for guidance. If “Yes” then continue to Step 2b. If “No” then stop here; <u>only</u> Standard Project requirements apply.</p>	<p><input type="checkbox"/> Yes <input type="checkbox"/> No</p>
<p>Step 2b. Do any of the exceptions to PDP definitions in this Manual apply to the project? See Section 1.4.3 for guidance. If “Yes” then stop here; Standard Project requirements apply, along with additional requirements that qualify the project for the exception. If “No” then continue to Step 3; the project is a PDP.</p>	<p><input type="checkbox"/> Yes <input type="checkbox"/> No</p>
<p>Step 3. Do hydromodification control requirements apply? See Section 1.6 for guidance. All Authority projects to say “No” then stop here; PDP with only pollutant control requirements apply to the project.</p>	<p><input type="checkbox"/> Yes <input type="checkbox"/> No</p>

1.2.2 Determine Applicability of Construction BMP Requirements

All projects, or phases of projects, even if exempted from meeting some or all Permanent BMP requirements, are required to implement temporary erosion, sediment, good housekeeping, and pollution prevention BMPs to mitigate storm water pollutants during the construction phase. See Section 5 and Appendix B (www.san.org/green) of the Authority SWMP for detailed information on these requirements.

1.3 Defining a Project

Not all site improvements are considered “development projects” under the MS4 Permit.

This Manual is intended for new development and redevelopment projects, including both private- and public-funded projects. Development projects are defined by the MS4 Permit as "construction, rehabilitation, redevelopment, or reconstruction of any public or private projects." Development projects are issued local permits to allow construction activities. To further clarify, this Manual applies only to development or redevelopment activities that have the potential to contact storm water and

contribute an anthropogenic source of pollutants or reduce the natural absorption and infiltration abilities of the land.

A project must be defined consistent with the California Environmental Quality Act definitions of "project."

CEQA defines a project as a discretionary action undertaken by a public agency that would have a direct or reasonably foreseeable indirect impact on the physical environment. This includes actions by the agency, financing and grants, and permits, licenses, plans, regulations, or other entitlements granted by the agency. CEQA requires that the project include "the whole of the action" before the agency. This requirement precludes "piecemealing," which is the improper (and often artificial) separation of a project into smaller parts to avoid preparing Environmental Impact Report (EIR)-level documentation.

In the context of this Manual, the "project" is the "whole of the action" that has the potential for adding or replacing or resulting in the addition or replacement of, roofs, pavement, or other impervious surfaces and thereby resulting in increased flows and storm water pollutants. "Whole of the action" means that the project may not be segmented or phased into small parts either onsite or offsite if the effect is to reduce the quantity of impervious area and fall below thresholds for applicability of storm water requirements.

When defining the project, the following questions are considered:

- What are the project activities?
- Do they occur onsite or offsite?
- What are the limits of the project (project boundary)?
- What is the "whole of the action" associated with the project (i.e., what is the total amount of new or replaced impervious area considering all collective project components through all phases of the project)?
- Are any facilities or agreements to build facilities offsite in conjunction with providing service to the project (street widening, utilities)?

Table 1-2 is used to determine whether storm water management requirements defined in the MS4 Permit and presented in this Manual apply to the project.

If a project meets one of the exemptions in Table 1-2, then permanent BMP requirements do not apply to the project; i.e., requirements in this Manual are not applicable. If permanent BMP requirements apply to a project, Sections 1.4 through 1.7 further define the extent of the applicable requirements based on the MS4 Permit. The MS4 Permit contains standard requirements that are applicable to all projects (Standard Projects and PDPs) and more specific requirements for projects that are classified as PDPs.

TABLE 1-2. Applicability of Permanent, Post-Construction Storm Water Requirements

Do permanent storm water requirements apply to your project?
<i>Requirements DO NOT apply to:</i>
<p>Replacement of impervious surfaces that are part of a routine maintenance activity, such as:</p> <ul style="list-style-type: none"> • Replacing roof material on an existing building • Restoring pavement or other surface materials affected by trenches from utility work • Resurfacing existing roads and parking lots, including slurry, overlay, and restriping • Routine replacement of damaged pavement if the sole purpose is to repair the damaged pavement • Resurfacing existing roadways, sidewalks, pedestrian ramps, or bike lanes on existing roads • Restoring a historic building to its original historic design • Installation of ground mounted solar arrays over existing impermeable surface. <p>Note: Work that creates impervious surface outside of the existing impervious footprint is not considered routine maintenance.</p> <p>Repair or improvements to an existing building or structure that do not alter the size:</p> <ul style="list-style-type: none"> • Plumbing, electrical, and heating, ventilation, and air conditioning (HVAC) work • Interior alterations, including major interior remodels and tenant build-out within an existing commercial building • Exterior alterations that do not increase existing impervious footprint and do not expose underlying soil during construction (e.g., roof replacement)

Please note that P&EAD may choose to designate a project that is not defined within any of the categories in Table 1-2 as a Standard Project or PDP, based on the project’s potential impacts on storm water quality.

1.4 Is the Project a PDP?

MS4 Permit Provision E.3.b.(1)

PDP categories are defined by the MS4 Permit, but the PDP categories can be expanded by the Authority, and the Authority can offer specific exemptions from PDP categories.

Section 1.4.1 presents the PDP categories defined in the MS4 Permit. Section 1.4.2 presents additional PDP categories and/or expanded PDP definitions that apply to the Authority. Section 1.4.3 presents specific Authority exemptions.

1.4.1 PDP Categories

In the MS4 Permit, PDP categories are defined by project size, type, and design features.

Projects shall be classified as PDPs if they are in one or more of the PDP categories presented in the MS4 Permit, which are listed below. Review each category, defined in (a) through (f), below. A PDP applicability checklist for these categories is also provided in Appendix A. If any of the categories

Chapter 1: Policies and Procedural Requirements

match the project, the entire project is a PDP. For example, if a project feature such as a parking lot falls into a PDP category, then the entire development footprint, including project components that otherwise would not have been designated a PDP on their own (such as other impervious components that did not meet PDP size thresholds, and/or landscaped areas), shall be subject to PDP requirements. Note that size thresholds for impervious surface created or replaced vary based on land use, land characteristics, and classification of the project as a new development or redevelopment project. Therefore, all definitions must be reviewed carefully. Also note that categories are defined by the total quantity of “added or replaced” impervious surface, not the net change in impervious surface.

For example, consider a redevelopment project that adds 7,500 square feet of new impervious surface and removes 4,000 square feet of existing impervious surface. The project has a net increase of 3,500 square feet of impervious surface. However, the project is still classified as a PDP because the total added or replaced impervious surface is 7,500 square feet, which is greater than 5,000 square feet.

"**Collectively**" for the purposes of the Manual means that all contiguous and non-contiguous parts of the project that represent the whole of the action must be summed. For example, consider a residential development project that will include the following impervious components:

- 3,600 square feet of roadway
- 350 square feet of sidewalk
- 4,800 square feet of roofs
- 1,200 square feet of driveways
- 500 square feet of walkways/porches

The collective impervious area is 10,450 square feet.

PDP Categories Defined by the MS4 Permit

- (a) New development projects that create 10,000 square feet or more of impervious surfaces (collectively over the entire project site). This category includes commercial, industrial, residential, mixed-use, and public development projects on public or private land.
- (b) Redevelopment projects that create and/or replace 5,000 square feet or more of impervious surface (collectively over the entire project site on an existing site of 10,000 square feet or more of impervious surfaces). This category includes commercial, industrial, residential, mixed-use, and public development projects on public or private land.
- (c) New and redevelopment projects that create and/or replace 5,000 square feet or more of impervious surface (collectively over the entire project site), and support one or more of the following uses:
 - (i) Restaurants. This category is defined as a facility that sells prepared foods and drinks for consumption, including stationary lunch counters and refreshment stands selling prepared foods and drinks for immediate consumption (Standard Industrial Classification [SIC] code 5812).

Information and an SIC search function are available at
<https://www.osha.gov/pls/imis/sicsearch.html>.

Chapter 1: Policies and Procedural Requirements

- (ii) Hillside development projects. This category includes development on any natural slope that is 25 percent or greater. This category is not applicable to SAN.
 - (iii) Parking lots. This category is defined as a land area or facility for the temporary parking or storage of motor vehicles used personally, for business, or for commerce.
 - (iv) Streets, roads, highways, freeways, and driveways. This category is defined as any paved impervious surface used for the transportation of automobiles, trucks, motorcycles, and other vehicles.
- (d) New or redevelopment projects that create and/or replace 2,500 square feet or more of impervious surface (collectively over the entire project site), and discharge directly to an Environmentally Sensitive Area (ESA). “Discharge directly to” includes flow that is conveyed overland a distance of 200 feet or less from the project to the ESA or is conveyed in a pipe or open channel any distance as an isolated flow from the project to the ESA (i.e., not commingled with flows from adjacent lands).

Note: ESAs are areas that include, but are not limited to, all Clean Water Act Section 303(d) [303(d)] impaired water bodies; areas designated as Areas of Special Biological Significance by the State Board and SDRWQCB; State Water Quality Protected Areas; water bodies designated with the Rare, Threatened, or Endangered Species (RARE) beneficial use by the State Board and SDRWQCB; and any other equivalent environmentally sensitive areas that have been identified by the Copermittee (see Section 1.4.2 to determine whether any other local areas have been identified).

For projects adjacent to an ESA, but not discharging to an ESA, the 2,500-square-foot threshold does not apply if the project does not physically disturb the ESA, and the ESA is upstream of the project. Drainage from SAN discharges to San Diego Bay, which is designated as an ESA because portions are contained in the 303(d) list. Certain areas of San Diego Bay are also subject to total maximum daily loads (TMDLs); however, SAN does not directly drain to these areas.

- (e) New development projects, or redevelopment projects that create and/or replace 5,000 square feet or more of impervious surface, and that support one or more of the following uses:
- (i) Automotive repair shops. This category is defined as a facility that is categorized in any one of the following SIC codes: 5013, 5014, 5541, 7532-7534, or 7536-7539.
Information and an SIC search function are available at <https://www.osha.gov/pls/imis/sicsearch.html>.
 - (ii) Retail gasoline outlets. This category includes retail gasoline outlets that meet the following criteria: (a) 5,000 square feet or more, or (b) a projected Average Daily Traffic value of 100 or more vehicles per day.
- (f) New or redevelopment projects that result in the disturbance of one or more acres of land and are expected to generate pollutants post construction.

Note: Pollutant-generating development projects are those projects that generate pollutants at levels greater than background levels. Background pollutant level means the pollutants generated from an undeveloped site. Projects disturbing one or more acres of land are presumed to generate pollutants post-construction unless the applicant presents a design that satisfies the City Engineer that pollutant concentrations in storm water discharges will not exceed pre-construction background levels.

Areas may be excluded from impervious area calculations for determining whether the project is a PDP:

- (a) Consistent with Table 1-2, areas of a project that are considered exempt from storm water requirements (e.g., routine maintenance activities, resurfacing, etc.) shall not be included as part of “added or replaced” impervious surface in determining project classification.

Redevelopment projects may have special considerations about the total area required to be treated. Refer to Section 1.7.

1.4.2 Local Additional PDP Categories and/or Expanded PDP Definitions

The Authority has not designated additional or expanded PDP categories but may choose to designate a project that is not defined within any of the categories in Section 1.4.1 as a PDP, based on the project’s potential impacts on storm water quality.

1.4.3 Local PDP Exemptions or Alternative PDP Requirements

The following types of development projects may be exempt from being defined as a PDP by the Authority if they meet the following conditions. Projects seeking PDP exemptions will be reviewed by P&EAD for eligibility:

- 1) New or retrofit paved sidewalks that are:
 - a) Designed to divert storm water runoff to vegetated or permeable areas;
 - b) Designed to be hydraulically disconnected from impervious streets or roads; or
 - c) Include permeable pavement or surfaces in accordance with USEPA Green Streets Guidance (Appendix I).
- 2) Retrofitting or redevelopment of existing paved alleys, streets or roads that are:
 - a) Designed in accordance with USEPA Green Streets Guidance (Appendix I).

1.5 Determining Applicable Storm Water Management Requirements

MS4 Permit Provision E.3.c.(1)

Depending on project type and receiving water, different storm water management requirements apply.

New development or redevelopment projects that are subject to this Manual requirement pursuant to Section 1.3 but are not classified as PDPs based on Section 1.4 are called "Standard Projects." Source control and site design requirements apply to all projects, including Standard Projects and PDPs. Additional structural BMP requirements (i.e., pollutant control) apply only to PDPs. Storm water management requirements for a project, and the applicable sections of this Manual, are summarized in Table 1-3.

TABLE 1-3. Applicability of Manual Sections for Different Project Types

Project Type	Project Development Process (Chapters 3 and 8)	Source Control and Site Design (Section 2.1 and Chapter 4)	Structural Pollutant Control (Section 2.2 and Chapters 5 and 7)	Structural Hydromodification Management (Section 2.3 and 2.4 and Chapters 6 and 7)
Not a Development Project	The requirements of this Manual do not apply			
Standard Project	☑	☑	NA	NA
PDP With Only Pollutant Control Requirements*	☑	☑	☑	NA
PDPs with Pollutant Control and Hydromodification Management Requirements	Hydromodification management requirements do not apply to Authority projects.			

1.6 Applicability of Hydromodification Management Requirements

MS4 Permit Provision E.3.c.(2)

As allowed by the MS4 Permit, projects discharging directly to enclosed embayments (e.g., San Diego Bay or Mission Bay), by either existing underground storm drain systems or conveyance channels whose bed and bank are concrete lined all the way from the point of discharge to the enclosed embayment, are exempt.

This exemption applies to all discharges from SAN, which discharges only to San Diego Bay. Development projects are to confirm within their SWQMPs that this exemption applies:

- 1) This exemption is subject to the following additional criteria defined by this Manual:
 - a) The outfall must not be located within a wildlife refuge or reserve area (e.g., Kendall-Frost Mission Bay Marsh Reserve, San Diego Bay National Wildlife Refuge, San Diego National Wildlife Refuge).
 - b) A properly sized energy dissipation system must be provided to mitigate outlet discharge velocity from the direct discharge to the enclosed embayment for the ultimate condition peak design flow of the direct discharge.
 - c) The invert elevation of the direct discharge conveyance system (at the point of discharge to the enclosed embayment) should be equal to or below the mean high tide water surface elevation at the point of discharge unless the outfall discharges to a quay or other non-erodible shore protection.
 - (i) For cases in which the direct discharge conveyance system outlet invert elevation is above the mean high tide water surface elevation by below the 100-year water surface

elevation, additional analysis is required to determine if energy dissipation should be extended between the conveyance system outlet and the elevation associated with the mean high tide water surface level.

- (ii) No exemption may be granted for conveyance system outlet invert elevations located above the 100-year floodplain elevation.
- 2) Exceptions to criteria b and c may be allowed on a case-by-case basis at the discretion of P&EAD.

1.7 Special Considerations for Redevelopment Projects (50% Rule)

MS4 Permit Provision E.3.b.(2)

Redevelopment PDPs (PDPs on previously developed sites) may need to meet storm water management requirements for ALL impervious areas (collectively) within the ENTIRE project site.

If the project is a redevelopment project, the structural BMP performance requirements apply to redevelopment PDPs as follows:

- 1) Where redevelopment results in the creation or replacement of impervious surface in an amount of less than 50 percent of the surface area of the previously existing development, then the structural BMP performance requirements of Provision E.3.c of the MS4 Permit apply only to the creation or replacement of impervious surface, and not the entire development; or
- 2) Where redevelopment results in the creation or replacement of impervious surface in an amount of more than 50 percent of the surface area of the previously existing development, then the structural BMP performance requirements of Provision E.3.c of the MS4 Permit apply to the entire development.

These requirements for managing storm water on an entire redevelopment project site are commonly referred to as the "50% rule." For calculating the ratio, the surface area of the previously existing development shall be the area of impervious surface within the previously existing development. The following steps shall be followed to estimate the area that requires treatment to satisfy the MS4 Permit requirements:

- 1) How much total impervious area currently exists on the site?
- 2) How much existing impervious area will be replaced with new impervious area?
- 3) How much new impervious area will be created in areas that are pervious in the existing condition?
- 4) Total created and/or replaced impervious surface = Step 2 + Step 3.
- 5) **50% rule test:** Is step 4 more than 50% of Step 1? If yes, treat all impervious surface on the site. If no, then treat only Step 4 impervious surface and any area that comingles with created and/or replaced impervious surface area.

Note: Steps 2 and Step 3 must not overlap because it is fundamentally not possible for a given area to be both “replaced” and “created” at the same time. Also, activities that occur as routine maintenance shall not be included in Step 2 and Step 3 calculation.

For example, a 10,000-square-foot development proposes replacement of 4,000 square feet of impervious area. The treated area is less than 50 percent of the total development area and only the 4,000-square-foot area is required to be treated.

1.8 Alternative Compliance Program

MS4 Permit Provision E.3.c.(1).(b); E.3.c.(2).(c); E.3.c.(3)

PDPs may be allowed to participate in an Alternative Compliance Program.

The Authority has the discretion to independently develop an alternative compliance program for its jurisdiction.

Participation in an ACP would allow a PDP to fulfill the requirement of providing retention and/or biofiltration pollutant controls onsite that completely fulfill the performance standards specified in Chapter 5 (pollutant controls) with onsite flow-through treatment controls and offsite mitigation of the design capture volume (DCV) not retained onsite.

PDPs may be allowed to participate in an ACP by using onsite BMPs to treat offsite runoff. PDPs must consult P&EAD for specific guidelines and requirements for using onsite facilities for alternative compliance.

The PDP using the ACP would (at a minimum) provide flow-through (FT) treatment control BMPs onsite, and then fund, contribute to, or implement an offsite alternative compliance project deemed by the Authority ACP to provide a greater overall water quality benefit for the portion of the pollutants not addressed onsite through retention and/or biofiltration BMPs. Offsite ACP locations for the purpose of this Manual are defined as locations within the Authority’s jurisdiction, but offsite of the PDP project area. Because of Federal Aviation Administration (FAA) funding restrictions, the Authority cannot fund or sponsor programs outside of its jurisdiction.

Figure 1-2 generally represents two potential pathways for participating in alternative compliance (i.e., offsite projects that supplement the PDP’s onsite BMP obligations):

- The first pathway (illustrated using solid line, left side) ultimately ends at alternative compliance if the PDP cannot meet all the onsite pollutant control obligations via retention and/or biofiltration. This pathway requires performing feasibility analysis for retention and biofiltration BMPs prior to participation in an alternative compliance project.
- The second pathway (illustrated using dashed line, right side) is a discretionary pathway along which jurisdictions may allow for PDPs to proceed directly to an ACP without demonstrating infeasibility of retention and/or biofiltration BMPs onsite.

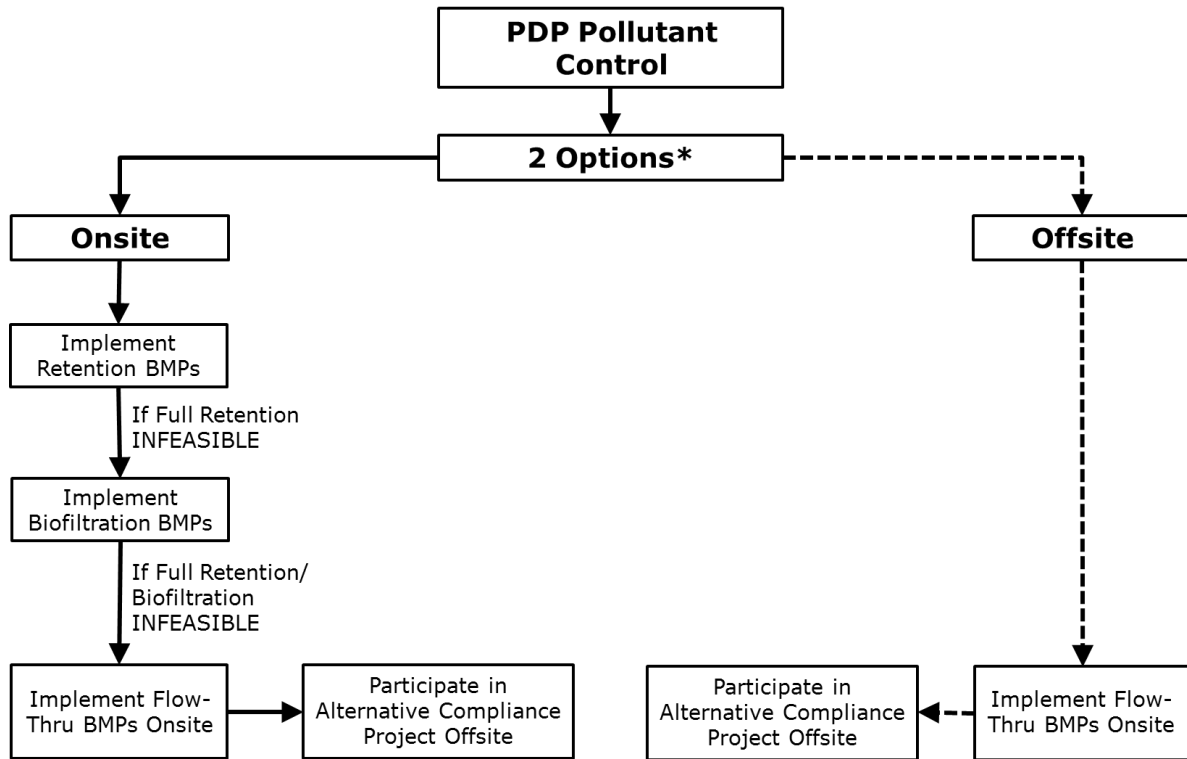

*PDP may be allowed to directly participate in an offsite project without demonstrating infeasibility of retention and/or biofiltration BMPs onsite. Consult P&EAD for specific guidelines.

FIGURE 1-2. Pathways to Participating in an Alternative Compliance Program

Participation in an ACP also requires onsite flow-through treatment control BMPs.

Participation in an offsite ACP, **and** the obligation to implement flow-through treatment controls for the DCV not reliably retained or biofiltered onsite, are linked and cannot be separated. Therefore, if the Authority does not allow the PDP to participate in the ACP or to propose a project-specific offsite alternative compliance project, then the PDP may not use flow-through treatment control. The PDP should consult P&EAD regarding processing requirements if this is the case.

PDPs may be required to provide temporal mitigation when participating in an alternative compliance program.

Finally, if the PDP is allowed to participate in an offsite ACP that is constructed after the completion of the development project, the PDP must provide temporal mitigation to address this interim period. Temporal mitigation must provide equivalent or better pollutant removal and/or hydrologic control (as applicable) compared with the case in which the offsite ACP is completed at the same time as the PDP.

Water Quality Equivalency Calculations

Water Quality Equivalency (WQE) calculations were approved on July 9, 2020, by the SDRWQCB Executive Officer as authorization to administer an ACP. The 2018 WQE Guidance Document for

Region 9² (WQE Guidance Document) provides currency calculations to assess water quality and hydromodification management benefits for a variety of potential offsite project types and provides a regional and technical basis for demonstrating a greater water quality benefit for the watershed. The WQE guidelines are available on the Project Clean Water website (www.projectcleanwater.org).

With approved WQE calculations, the Authority prepared a WQE Credit Trading Framework (Framework), which provides a framework for implementing water quality credit trading at SAN. This Framework was approved by the SDRWQCB on July 9, 2020. Water quality credits calculated per WQE Guidance Document can be used to partially or wholly satisfy pollutant control requirements for a proposed PDP through an ACP that achieves “greater overall water quality benefit.” Appendix J further discusses the Authority’s ACP.

1.9 Relationship Between This Manual and Water Quality Improvement Plans

This Manual is connected to other permit-specified planning efforts.

The MS4 Permit requires each Watershed Management Area within the San Diego Region to develop a Water Quality Improvement Plan (WQIP) that identifies priority and highest priority water quality conditions and strategies that will be implemented with associated goals to demonstrate progress toward addressing the conditions in the watershed. The MS4 Permit also provides an option to perform a Watershed Management Area Analysis (WMAA) as part of the WQIP to develop watershed-specific requirements for structural BMP implementation in the watershed management area.

PDPs should expect to consult either of these separate planning efforts as appropriate when using this Manual as follows:

- 1) For PDPs that implement flow-through treatment BMPs, selection of the type of BMP shall consider the pollutants and conditions of concerns. Among the selection considerations, the PDP must consult the highest priority water quality condition as identified in the WQIP for that watershed management area. The highest priority water quality condition identified in the San Diego Bay WQIP by the Authority is impairment due to metals (copper and zinc).
- 2) There may be watershed management area specific BMPs or strategies that are identified in WQIPs that PDPs should consult and incorporate as appropriate.
- 3) PDPs may have the option of participating in an ACP. Refer to Section 1.8.

These relationships between this Manual and WQIPs are presented in Figure 1-3.

² [WQE Guidance Document Region 9 May 2018](#)

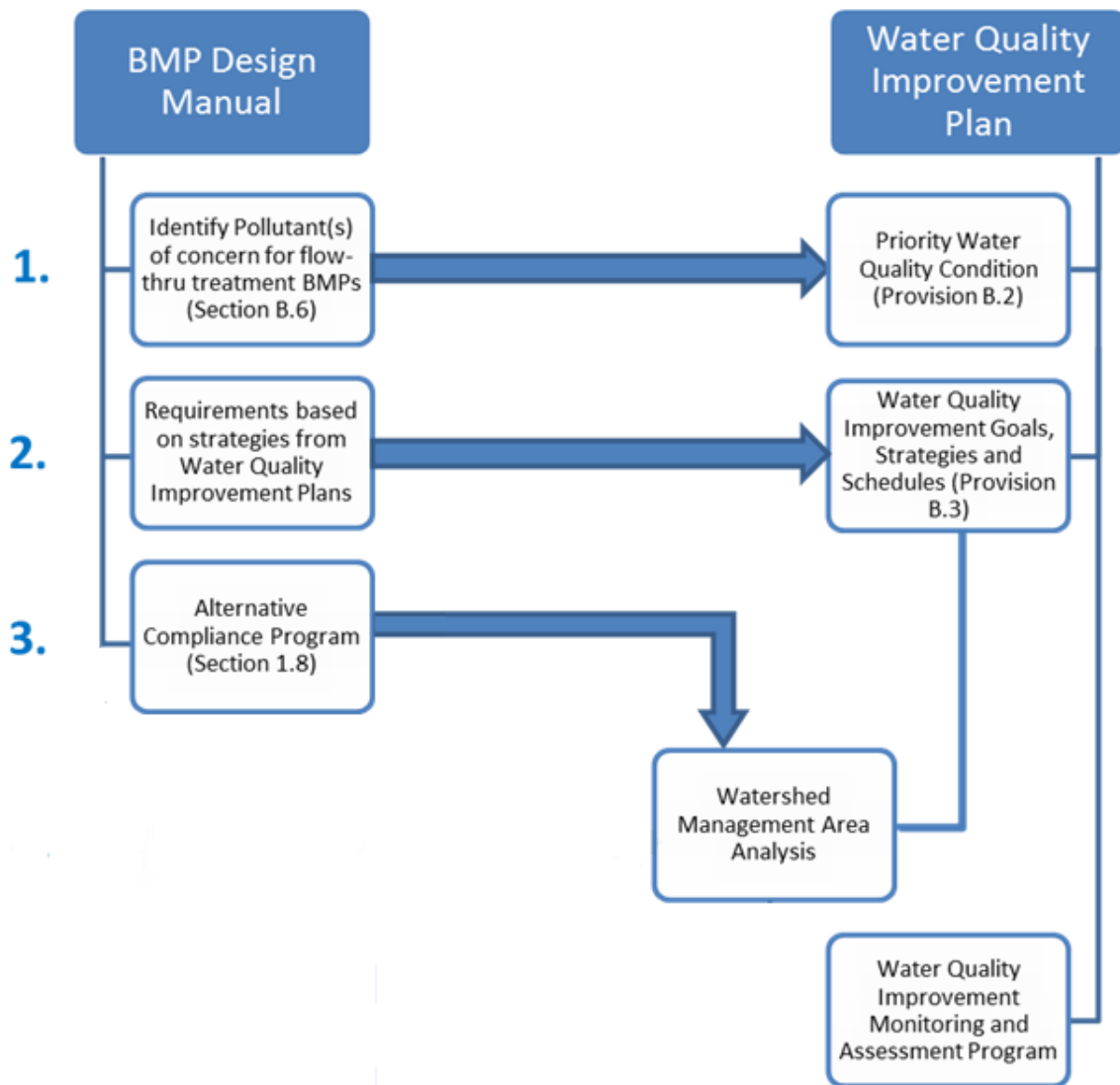

FIGURE 1-3. Relationship Between This Manual and the WQIP

1.10 Project Review Procedures

P&EAD reviews project plans for compliance with applicable requirements of this Manual and the MS4 Permit.

Specific submittal requirements are discussed in Chapter 8, and it is the project applicant’s responsibility to provide sufficient documentation to demonstrate that applicable requirements of the BMP Design Manual and the MS4 Permit will be met.

For Standard Projects, this means using forms and/or a Standard Project SWQMP or other equivalent documents approved by P&EAD to document that the following general requirements (GRs) of the MS4 Permit are met, and showing applicable features, including onsite grading, building, improvement, and landscaping plans:

- BMP Requirements for All Development Projects, which include general requirements, source control BMP requirements, and narrative (i.e., not numerically sized) site design requirements (MS4 Permit Provision E.3.a).

For PDPs, this means preparing a PDP SWQMP to document that the following general requirements of the MS4 Permit are met, and showing applicable features including onsite grading and landscaping plans:

- BMP Requirements for All Development Projects, which include general requirements for siting of permanent, post-construction BMPs, source control BMP requirements, and narrative (i.e., not numerically sized) site design requirements (MS4 Permit Provision E.3.a); and
- Storm Water Pollutant Control BMP Requirements, for numerically sized onsite structural BMPs to control pollutants in storm water (MS4 Permit Provision E.3.c.(1)).

Detailed submittal requirements are provided in Chapter 8. Documentation of the permanent, post-construction storm water BMPs at the discretion of P&EAD must be provided with the first submittal of a project or another preliminary planning stage defined by the Authority. Storm water requirements directly affect the layout of the project. Therefore, storm water requirements must be considered from the initial project planning phases, and are reviewed with each submittal, beginning with the first submittal.

1.11 PDP Structural BMP Verification

MS4 Permit Provision E.3.e.(1)

Structural BMPs must be verified by the Authority prior to project occupancy.

Pursuant to MS4 Permit Provision E.3.e.(1), each Copermittee must require and confirm the following with respect to PDPs constructed within their jurisdiction:

- 1) “Each Copermittee must require and confirm that appropriate easements and ownerships are properly recorded in public records and the information is conveyed to all appropriate parties when there is a change in project or site ownership.”
- 2) “Each Copermittee must require and confirm that, prior to occupancy and/or intended use of any portion of the [PDP], each structural BMP is inspected to verify that it has been constructed and is operating in compliance with all of its specifications, plans, permits, ordinances, and the requirements of [the MS4 Permit].”

For PDPs, this means that after structural BMPs have been constructed, the Authority may request the project owner provide a certification that the site improvements for the project have been constructed in conformance with the approved storm water management documents and drawings.

The Authority may require inspection of the structural BMPs at each significant construction stage and at completion. Following construction, the Authority may require an addendum to the SWQMP and As-Built to address any changes to the structural BMPs that occurred during construction that were approved by the Authority. The Authority may also require a final update to the O&M Plan

Chapter 1: Policies and Procedural Requirements

and/or execution of a maintenance agreement that will be recorded for the facility. A maintenance agreement that is recorded with the facility can then be transferred to future operators.

Certification of structural BMPs, updates to reports, and documentation of a maintenance agreement may occur concurrently with project closeout but could be required sooner per Authority practices. In all cases, it is required prior to occupancy and/or intended use of the project. Specific procedures are provided in Chapter 8.

This page intentionally left blank

Performance Standards and Concepts

Projects must meet three separate performance standards, as applicable.

The MS4 Permit establishes separate performance standards for (1) source control and site design practices, (2) storm water pollutant control BMPs, and (3) hydromodification management BMPs. Chapter 1 provided guidance for determining the performance standards that apply to a given project. This chapter defines these performance standards based on the MS4 Permit and presents concepts that provide the project applicant with technical background, explains why the performance standards are important, and gives a general description of how these performance standards can be met. Detailed procedures for meeting the performance standards are presented in Chapters 4, 5, and 6.

Performance standards can be met through an integrated approach.

Although three separate performance standards are defined by this Manual, an overlapping set of design features can be used as part of demonstrating conformance to each standard. Further discussion of the relationship between performance standards is provided in Section 2.4.

2.1 Source Control and Site Design Requirements for All Development Projects

2.1.1 Performance Standards

MS4 Permit Provision E.3.a

This section defines performance standards for source control and site design practices that are applicable to all projects (regardless of project type or size; both Standard Projects and PDPs) when local permits are issued, including unpaved roads and flood management projects.

2.1.1.1 General Requirements

All projects shall meet the following general requirements:

- 1) Onsite BMPs must be located to remove pollutants from runoff prior to its discharge to any receiving waters, and as close to the source as possible;

- 2) Structural BMPs must not be constructed within waters of the United States (U.S.); and
- 3) Onsite BMPs must be designed and implemented with measures to avoid the creation of nuisance or pollution associated with vectors (e.g., mosquitoes, rodents, or flies).

2.1.1.2 Source Control Requirements

Pollutant source control BMPs are features that must be implemented to address specific sources of pollutants.

The following source control BMPs must be implemented at all development projects where applicable and technically feasible:

- 1) Prevention of illicit discharges into the MS4;
- 2) Storm drain system stenciling or signage;
- 3) Protection of outdoor material storage areas from rainfall, run-on, runoff, and wind dispersal;
- 4) Protection of materials stored in outdoor work areas from rainfall, run-on, runoff, and wind dispersal;
- 5) Protection of trash storage areas from rainfall, run-on, runoff, and wind dispersal; and
- 6) Use of any additional BMPs determined to be necessary by the Authority to minimize pollutant generation at each project.

Further guidance is provided in Section 2.1.2 and Chapter 4. Additionally, all BMPs relevant to the Authority's jurisdiction are in Appendix B of the SWMP.

2.1.1.3 Site Design Requirements

Site design requirements are qualitative requirements that apply to the layout and design of ALL development project sites (Standard Projects and PDPs).

Site design performance standards define minimum requirements for how a site must incorporate LID BMPs, including the locations of BMPs and the use of integrated site design practices. The following site design practices must be implemented at all development projects, where applicable and technically feasible:

- 1) Maintenance or restoration of natural storage reservoirs and drainage corridors (including topographic depressions, areas of permeable soils, natural swales, and ephemeral and intermittent streams)³;
- 2) Buffer zones for natural water bodies (where buffer zones are technically infeasible, require project applicant to include other buffers such as trees, access restrictions, etc.);
- 3) Conservation of natural areas within the project footprint, including existing trees, other vegetation, and soils;

³ Development projects proposing to dredge or fill materials in waters of the U.S. must obtain a Clean Water Act Section 401 Water Quality Certification. Projects proposing to dredge or fill waters of the state must obtain waste discharge requirements.

Chapter 2: Performance Standards and Concepts

- 4) Construction of streets, sidewalks, or parking lot aisles to the minimum widths necessary, provided public safety is not compromised;
- 5) Minimization of the impervious footprint of the project;
- 6) Minimization of soil compaction to landscaped areas;
- 7) Disconnection of impervious surfaces through distributed pervious areas;
- 8) Landscaped or other pervious areas designed and constructed to effectively receive and infiltrate, retain and/or treat runoff from impervious areas, prior to discharging to the MS4;
- 9) Small collection strategies located at, or as close as possible to, the source (i.e., the point where storm water initially meets the ground) to minimize the transport of runoff and pollutants to the MS4 and receiving waters;
- 10) Use of permeable materials for projects with low traffic areas and appropriate soil conditions;
- 11) Landscaping with native or drought tolerant species; and
- 12) Harvesting and use of precipitation.

A key aspect of this performance standard is that these design features must be used where applicable and feasible. Responsible implementation of this performance standard depends on evaluating applicability and feasibility. Further guidance is provided in Section 2.1.2 and Chapter 4.

Additional site design requirements may apply to PDPs.

Site design decisions may influence the ability of a PDP to meet applicable performance standards for pollutant control (as defined in Section 2.2). For example, the layout of the site drainage and reservation of areas for BMPs relative to areas of infiltrative soils may influence the feasibility of capturing and managing storm water to meet storm water pollutant control requirements. As such, the Authority may require additional site design practices, beyond those listed above, to be considered and documented as part of demonstrating conformance to storm water pollutant control requirements.

2.1.2 Concepts and References

Land development tends to increase the amount of pollutants in storm water runoff.

Land development generally alters the natural conditions of the land by removing vegetative cover, compacting soil, and/or affecting placement of concrete, asphalt, or other impervious surfaces. These impervious surfaces facilitate entrainment of urban pollutants in storm water runoff (such as pesticides, petroleum hydrocarbons, heavy metals, and pathogens) that are otherwise not generally found in high concentrations in the runoff from the natural environment. Pollutants that accumulate on impervious surfaces and actively landscaped pervious surfaces may contribute to elevated levels of pollutants in runoff relative to the natural condition.

Land development also impacts site hydrology.

Impervious surfaces greatly affect the natural hydrology of the land because they do not allow natural infiltration, retention, evapotranspiration, and treatment of storm water runoff to take place. Instead, storm water runoff from impervious surfaces is typically and has traditionally been directed through pipes, curbs, gutters, and other hardscape into receiving waters, with little treatment, at significantly

increased volumes and accelerated flow rates over what would occur naturally. The increased pollutant loads, storm water volume, discharge rates and velocities, and discharge durations from the MS4 adversely impact stream habitat by causing accelerated, unnatural erosion and scouring within creek beds and banks. Compaction of pervious areas can have a similar effect as impervious surfaces on natural hydrology.

Site design LID involves attempting to maintain or restore the predevelopment hydrologic regime.

LID is a comprehensive land planning and engineering design approach with a goal of maintaining and enhancing the pre-development hydrologic regime of urban and developing watersheds. LID designs seek to control storm water at the source, using small-scale integrated site design and management practices to mimic the natural hydrology of a site, retain storm water runoff by minimizing soil compaction and impervious surfaces, and disconnect storm water runoff from conveyances to the storm drain system. Site design LID BMPs may use interception, storage, evaporation, evapotranspiration, infiltration, and filtration processes to retain and/or treat pollutants in storm water before it is discharged from a site. Examples of site design LID BMPs include permeable pavements, rain gardens, rain barrels, grassy swales, soil amendments, and native plants.

Site design must be considered early in the design process.

Site designs tend to be more flexible in the early stages of project planning than later when plans become more detailed. Because of the importance of the location of BMPs, site design shall be considered as early as the planning/tentative design stage. Site design is critical for feasibility of storm water pollutant control BMPs (Section 2.2).

Source control and site design (LID) requirements help avoid impacts by controlling pollutant sources and changes in hydrology.

Source control and site design practices prescribed by the MS4 Permit are the minimum management practices, control techniques and system, design, and engineering methods to be included in the planning procedures to reduce the discharge of pollutants from development projects, regardless of size or purpose of the development. In contrast to storm water pollutant control BMPs, which are intended to mitigate impacts, source control and site design BMPs are intended to avoid or minimize these impacts by managing site hydrology, providing treatment features integrated within the site, and reducing or preventing the introduction of pollutants from specific sources. Implementation of site design BMPs results in reduction in storm water runoff generated by the site. Methods to estimate effective runoff coefficients and the storm water runoff produced by the site after site design BMPs are implemented are presented in Appendix B.2. This methodology is applicable for PDPs that are required to estimate runoff produced from the site with site design BMPs implemented so that they can appropriately size storm water pollutant control BMPs.

The location of BMPs matters.

The site design BMPs listed in the performance standard include practices that either prevent runoff from occurring or manage runoff as close to the source as possible. These BMPs help create a more hydrologically effective site and reduce the requirements that pollutant control BMPs must meet, where required. Additionally, because sites may have spatially variable conditions, the locations reserved for structural BMPs within the site can influence whether these BMPs can feasibly retain, treat, and/or detain storm water to comply with structural pollutant control requirements, where

applicable. Finally, the performance standard specifies that onsite BMPs must remove pollutants from runoff prior to discharge to any receiving waters or the MS4 must be located/constructed as close to the pollutant generating source as possible, and must not be constructed within waters of the U.S.

The selection of BMPs also matters.

The lists of source control and site design BMPs specified in the performance standard must be used “where applicable and feasible.” This is an important concept – BMPs should be selected to meet the MS4 permit requirements and are feasible with consideration of site conditions and project type. By using BMPs that are applicable and feasible, the project can achieve benefits of these practices, while not incurring unnecessary expenses (associated with using practices that do not apply or would not be effective) or creating undesirable conditions (e.g., infiltration-related issues, vector concerns including mosquito breeding, etc.).

Methods to select and design BMPs and demonstrate compliance with source control and site design requirements are presented in Chapter 4.

2.2 Storm Water Pollutant Control Requirements for PDPs

2.2.1 Storm Water Pollutant Control Performance Standard

MS4 Permit Provision E.3.c.(1)

Storm water pollutant control BMPs for PDPs shall meet the following performance standards:

- (a) Each PDP shall implement BMPs that are designed to retain (i.e., intercept, store, infiltrate, evaporate, and evapotranspire) onsite the pollutants contained in the volume of storm water runoff produced from a 24-hour, 85th percentile storm event (DCV). The 24-hour, 85th percentile storm event shall be based on Figure B.1-1 in Appendix B or an approved site-specific rainfall analysis.
 - (i) If it is not technically feasible to implement retention BMPs for the full DCV onsite for a PDP, then the PDP shall use biofiltration BMPs for the remaining volume not reliably retained. Biofiltration BMPs must be designed as described in Appendix F to have an appropriate hydraulic loading rate to maximize storm water retention and pollutant removal and to prevent erosion, scour, and channeling within the BMP, and must be sized to:
 - [a]. Treat 1.5 times the DCV not reliably retained onsite, OR
 - [b]. Treat the DCV not reliably retained onsite with a flow-through design that has a total volume, including pore spaces and pre-filter detention volume, sized to hold at least 0.75 times the portion of the DCV not reliably retained onsite.
 - (ii) If biofiltration BMPs are not technically feasible, then the PDP shall use flow-through treatment control BMPs (selected and designed per Appendix B.6) to treat runoff leaving the site AND participate in alternative compliance to mitigate for the pollutants from the DCV not reliably retained onsite pursuant to Section 2.2.1.(b). Flow-through treatment control BMPs must be sized and designed to:

Chapter 2: Performance Standards and Concepts

- [a]. Remove pollutants from storm water to the MEP (defined by the MS4 Permit) by following the guidance in Appendix B.6; and
 - [b]. Filter or treat either (1) the maximum flow rate of runoff produced from a rainfall intensity of 0.2 inch of rainfall per hour for each hour of a storm event, or (2) the maximum flow rate of runoff produced by the 85th percentile hourly rainfall intensity (for each hour of a storm event), as determined from the local historical rainfall record, multiplied by a factor of 2 (both methods may be adjusted for the portion of the DCV retained onsite as described in Appendix B.6); and
 - [c]. Meet the flow-through treatment control BMP treatment performance standard described in Appendix B.6.
- (b) A PDP may be allowed to participate in an ACP in lieu of fully complying with the performance standards for storm water pollutant control BMPs onsite if the ACP outlined in Section 1.8 is followed. When an ACP is used:
- (i) The PDP must mitigate for the portion of the DCV not reliably retained onsite.
 - (ii) Flow-through treatment control BMPs must be implemented to treat the portion of the DCV that is not reliably retained onsite. Flow-through treatment control BMPs must be selected and sized in accordance with Appendix B.6.
 - (iii) A PDP may be allowed to propose an ACP not identified in the WMAA of the WQIP if the requirements in Section 1.8 are met at the discretion of P&EAD.

Demonstrations of feasibility findings and calculations to justify BMP selection and design shall be provided by the project applicant in the SWQMP to the satisfaction of P&EAD. Methodology to demonstrate compliance with the performance standards, described above, applicable to storm water pollutant control BMPs for PDPs, is detailed in Chapter 5.

2.2.2 Concepts and References

Retention BMPs are the most effective type of BMPs to reduce pollutants discharging to MS4s when they are sited and designed appropriately.

Retention of the required DCV will achieve 100 percent pollutant removal efficiency (i.e., prevent pollutants from discharging directly to the MS4). Thus, retention of as much storm water onsite as technically feasible is the most effective way to reduce pollutants in storm water discharges to, and consequently from, the MS4 and remove pollutants in storm water discharges from a site to the MEP.

However, to accrue these benefits, retention BMPs must be technically feasible and suitable for the project. Retention BMPs that fail prematurely, under-perform, or result in unintended consequences because of improper selection or siting may be less effective than other BMP types and pose other issues for tenants and the Authority. Therefore, this Manual provides criteria for evaluating feasibility and options for other types of BMPs to be used if retention is not technically feasible.

Biofiltration BMPs can be sized to achieve approximately the same pollutant removal as retention BMPs.

In the case in which the entire DCV cannot be retained onsite because it is not technically feasible, PDPs are required to use biofiltration BMPs with specific sizing and design criteria listed in Appendices B.5 and F. These sizing and design criteria are intended to provide a level of long-term pollutant removal that is reasonably equivalent to retention of the DCV.

Flow-through treatment BMPs are required to treat the pollutant loads in the DCV not retained or biofiltered onsite to the MEP.

If the pollutant loads from the full DCV cannot feasibly be retained or biofiltered onsite, then PDPs are required to implement flow-through treatment control BMPs to remove the pollutants to the MEP for the portion of the DCV that could not be feasibly retained or biofiltered. Flow-through treatment BMPs may be implemented to address onsite storm water pollutant control requirements only if coupled with an offsite ACP that mitigates the portion of the pollutant load in the DCV not retained or biofiltered onsite.

Offsite Alternative Compliance Program may be available.

The MS4 Permit allows the Authority discretion to grant PDPs permission to use an ACP for meeting the pollutant control performance standard. Onsite and offsite mitigation is required when a PDP is allowed to use an ACP. The specific parameters of the Authority's ACP are in Appendix J.

Methods to design and demonstrate compliance with storm water pollutant control BMPs are presented in Chapter 5. Definitions and concepts that should be understood when sizing storm water pollutant control BMPs to comply with the performance standards are explained in the following subsections.

2.2.2.1 Best Management Practices

To minimize confusion, this Manual considers all references to “facilities,” “features,” or “controls” to be incorporated into development projects as BMPs.

2.2.2.2 DCV

The MS4 Permit requires pollutants be addressed for the runoff from the 24-hour, 85th percentile storm event (“DCV”) as the design standard to which PDPs must comply.

The 24-hour, 85th percentile storm event is the event that has a precipitation total greater than or equal to 85 percent of all storm events over a given period of record in a specific area or location. For example, to determine the 85th percentile storm event in a specific location, the following steps would be followed:

- Obtain representative precipitation data, preferably no less than 30-year period, if possible.
- Divide the recorded precipitation into 24-hour precipitation totals.
- Filter out events with no measurable precipitation (less than 0.01 inch of precipitation).
- Of the remaining events, calculate the 85th percentile value (i.e., 15 percent of the storms would be greater than the number determined to be the 24-hour, 85th percentile storm).

The 24-hour, 85th percentile storm event depth is then used in hydrologic calculations to calculate the DCV for sizing storm water pollutant control BMPs. An exhibit showing the 24-hour, 85th percentile storm depth across San Diego County and the methodology used to develop this exhibit is included in Appendix B.1.2. The 24-hour, 85th percentile storm event depth for SAN is 0.5 inch. Guidance to estimate the DCV is presented in Appendix B.1.

2.2.2.3 Implementation of Storm Water Pollutant Control BMPs

The MS4 Permit requires that the PDP applicants proposing to meet the performance standards onsite implement storm water pollutant control BMPs in the order listed below. That is, the PDP applicant first needs to implement **all** feasible onsite retention BMPs needed to meet the storm water pollutant control BMP requirements prior to installing onsite biofiltration BMPs, and then onsite biofiltration BMPs prior to installing onsite flow-through treatment control BMPs.

PDPs may be allowed to participate in an ACP. Section 1.8 provides additional guidance.

Retention BMPs: Structural measures that provide retention (i.e., intercept, store, infiltrate, evaporate, and evapotranspire) of storm water as part of pollutant control strategy. Examples include infiltration BMPs and cisterns, bioretention BMPs, and biofiltration with partial retention (PR) BMPs.

Biofiltration BMPs: Structural measures that provide biofiltration of storm water as part of the pollutant control strategy. Example includes biofiltration BMPs.

Flow-through treatment control BMPs: Structural measures that provide flow-through treatment as part of the pollutant control strategy. Examples include vegetated swales and media filters.

For example, if the DCV from a site is 10,000 cubic feet (ft³) and it is technically feasible to implement 2,000 ft³ of retention BMPs and 9,000 ft³ of biofiltration BMPs sized using Section 2.2.1.(a)(if)[a], and the jurisdiction has an ACP to satisfy the requirements of this Manual the project applicant should:

- 1) First, design retention BMPs for 2,000 ft³.
- 2) Then complete a technical feasibility form for retention BMPs (included in Appendices C and D), demonstrating that it is technically feasible only to implement retention BMPs for 2,000 ft³.
- 3) Then design biofiltration BMPs for 9,000 ft³ (calculate equivalent volume for which the pollutants are retained = $9,000/1.5 = 6,000$ ft³).
- 4) Then complete a technical feasibility for biofiltration BMPs, demonstrating that it is technically feasible only to implement biofiltration BMPs for 9,000 ft³.
- 5) Estimate the DCV that could not be retained or biofiltered = $10,000$ ft³ – ($2,000$ ft³ + $6,000$ ft³) = $2,000$ ft³.
- 6) Implement flow-through treatment control BMPs to treat the pollutants in the remaining 2,000 ft³. Refer to Appendix B.6 for guidance for designing flow-through treatment control BMPs.
- 7) Also participate in an ACP for 2,000 ft³. Refer to Section 1.8 for additional guidance on participation in an ACP.

2.2.2.4 Technical Feasibility

MS4 Permit Requirement E.3.c.(5)

Analysis of technical feasibility is necessary to select the appropriate BMPs for a site.

PDPs are required to implement pollutant control BMPs in the order of priority in Section 2.2.2.3 based on determinations of technical feasibility. To assist the project applicant in selecting BMPs, this Manual includes a defined process for evaluating feasibility. Conceptually, the feasibility criteria contained in this Manual are intended to:

- Promote reliable and effective long-term operations of BMPs by providing a BMP selection process that eliminates the use of BMPs that are not suitable for site conditions, project type or other factors;
- Minimize significant risks to property, human health, and/or environmental degradation (e.g., geotechnical stability, groundwater quality) because of selection of BMPs that are undesirable for a given site; and
- Describe circumstances under which regional and watershed-based strategies, as part of an approved WMAA **and** an ACP developed by the Authority, may be selected.

Steps for performing technical feasibility analyses are described in detail in Chapter 5. More specific guidance related to geotechnical investigation guidelines for feasibility of storm water infiltration and groundwater quality and water balance factors is provided in Appendices C and D, respectively.

2.2.2.5 Biofiltration BMPs

The MS4 Permit requires that biofiltration BMPs be designed to have an appropriate hydraulic loading rate to maximize storm water retention and pollutant removal and to prevent erosion, scour, and channeling within the BMP. Appendix F has guidance for hydraulic loading rates and other biofiltration design criteria to meet these required goals. Appendix F also has a checklist to be completed by the project SWQMP preparer during plan submittal. Guidance for sizing biofiltration BMPs is included in Chapter 5 and Appendices B.5 and F.

2.2.2.6 Flow-through Treatment Control BMPs (for use with Alternative Compliance)

MS4 Permit Requirement E.3.d.2-3

The MS4 Permit requires that the flow-through treatment control BMP selected by the PDP applicant be ranked with high or medium pollutant removal efficiency for the most significant pollutant of concern. The following steps are used to select the flow-through treatment control BMP:

- Step 1: Identify the pollutant(s) of concern by considering the following at a minimum (1) receiving water quality; (2) highest priority water quality conditions identified in the Watershed Management Areas Water Quality Improvement Plan; (3) land use type of the project and pollutants associated with that land use type, and (4) pollutants expected to be present onsite

- Step 2: Identify the most significant pollutant of concern. A project could have multiple most-significant pollutants of concerns and shall include the highest priority water quality condition identified in the watershed WQIP (i.e., copper and zinc in wet weather for the Authority) and pollutants expected to be presented onsite/from land use.
- Step 3: Determine the effectiveness of the flow-through treatment control BMP for the identified most significant pollutant of concern.

The methodology for sizing flow-through treatment control BMPs and the resources required to identify the pollutant(s) of concern and effectiveness of flow-through treatment control BMPs are included in Chapter 5 and Appendix B.6.

2.3 Hydromodification Management Requirements for PDPs

2.3.1 Hydromodification Management Performance Standards

MS4 Permit Provision E.3.c.(2)

The MS4 Permit defines performance standards for hydromodification management, including flow control of post-project storm water runoff and protection of critical sediment yield areas, that shall be met by all PDPs unless exempt from hydromodification management requirements per Section 1.6. Hydromodification management requirements apply to both new development and redevelopment PDPs, except those that are exempt based on discharging to downstream channels or water bodies that are not subject to erosion, as defined in either the MS4 Permit (Provision E.3.c.(2).(d)) or the WMAA for the watershed in which the project resides. Exemptions from hydromodification management requirements are described in Section 1.6.

All projects discharging storm water from SAN are exempt from hydromodification management requirements because all discharges drain to an enclosed embayment (San Diego Bay). Project applicants are to state in the project SWQMP that the hydromodification management exemption outlined in Section 1.6 applies to their projects.

2.4 Relationship Among Performance Standards

An integrated approach can provide significant cost savings by utilizing design features that meet multiple standards.

Site design/LID and storm water pollutant control are separate requirements to be addressed in development project design. Each has its own purpose, and each has separate performance standards that must be met. However, effective project planning involves understanding the ways in which these standards are related and how single suites of design features can meet more than one standard.

Site design features (aka LID) can be effective at reducing the runoff to downstream BMPs.

Site design BMPs serve the purpose of minimizing impervious areas and therefore reducing post-project runoff, the potential transport of pollutants offsite, and the potential for downstream erosion caused by increased flow rates and durations. By reducing post-project runoff through site design BMPs, the amount of runoff that must be managed for pollutant control can be reduced.

Single structural BMPs, particularly retention BMPs, can meet or contribute to pollutant control objectives.

The objective of structural BMPs for pollutant control is to reduce offsite transport of pollutants. The most effective structural BMPs to meet the objective are BMPs that are based on retention of storm water runoff where feasible. Both storm water pollutant control and flow control for hydromodification management can be achieved within the same structural BMP(s). However, demonstrating that the separate performance requirements for pollutant control and hydromodification management are met must be shown separately. Because hydromodification management is not required by the Authority, only pollutant control requirements must be demonstrated.

The design process should start with an assessment of the feasibility to retain or partially retain the DCV for pollutant control, and then determine the type of BMPs to be used for pollutant control.

A typical design process for a single structural BMP to meet the pollutant control performance standard involves initiating the structural BMP design based on the performance standard that is expected to require the largest volume of storm water to be retained.

This page intentionally left blank

Development Project Planning and Design

Compliance with source control/site design and pollutant control BMPs, as applicable, requires coordination of site, landscape, and project storm water plans. It also involves provisions for O&M of structural BMPs. To effectively comply with applicable requirements, a stepwise approach is recommended. This chapter outlines a stepwise, systematic approach (Figure 3-1) for preparing a comprehensive storm water management design for Standard Projects and PDPs.

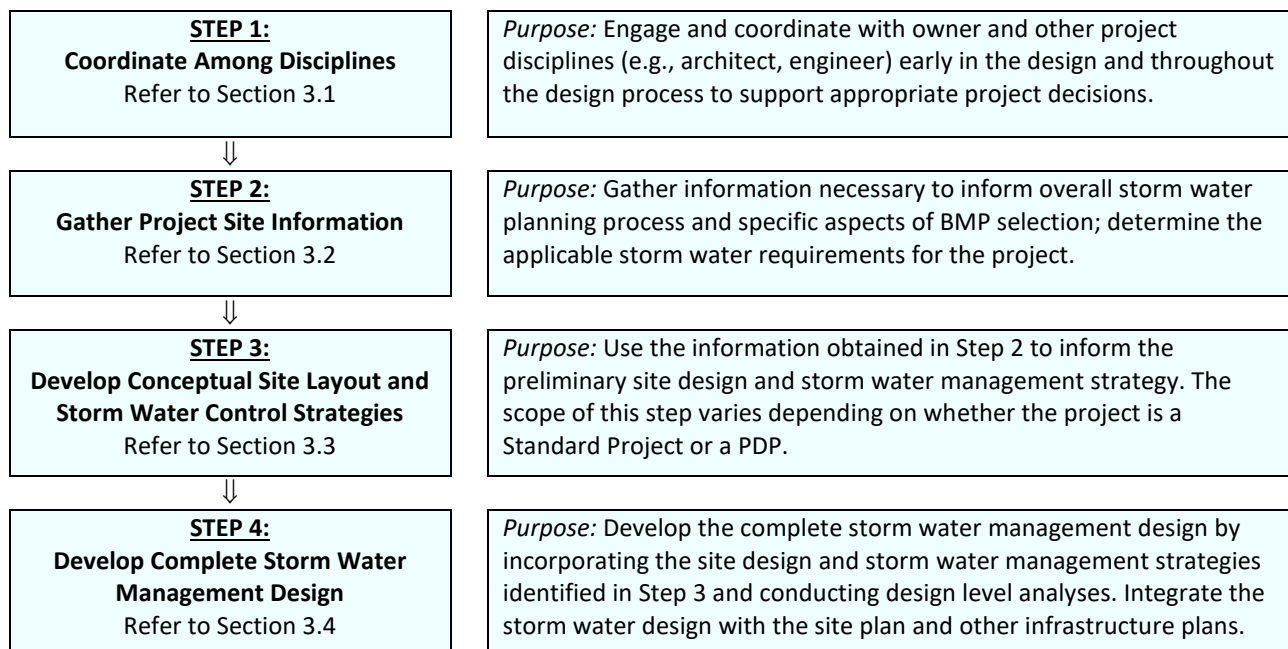

FIGURE 3-1. Approach for Developing a Comprehensive Storm Water Management Design

A stepwise approach is not mandatory, and adaptation of this stepwise approach to better fit with unique project features is encouraged. However, taking a stepwise, systematic approach of some sort for planning and design has several advantages. First, it helps ensure that applicable requirements and design goals are identified early in the process. Second, it helps ensure that key data about the site, watershed, and project are collected at the appropriate time in the project development process, and the analyses are suited to the decisions that need to be made at each phase. Third, taking a systematic approach helps identify opportunities for retention of storm water that may not be identified in a less systematic process. Finally, a systematic approach helps ensure that constraints and unintended

consequences are considered and used to inform BMP selection and design, and related project decisions.

Authority-specific special requirements are listed in Section 3.5, and requirements for phased projects are in Section 3.6. It is recommended that a preliminary site design be submitted prior to formally applying for project approvals. The preliminary site design should incorporate a conceptual plan for site drainage, including self-treating and self-retaining areas and the location and approximate sizes of any treatment facilities. Any initial feasibility assessments for retaining the full DCV onsite should also be provided. This additional up-front design effort will likely save time and avoid potential delays later in the review process.

3.1 Coordination Among Disciplines

Storm water management design requires close coordination among multiple disciplines because storm water management design affects the site layout and should therefore be coordinated among the project team as necessary from the start. The following are entities/disciplines that are frequently involved with storm water management design, along with their potential roles:

Owner:

- Engage the appropriate disciplines needed for the project and facilitate exchange of information between disciplines.
- Identify who will be responsible for long-term O&M of storm water management features, and initiate maintenance agreements when applicable.
- Ensure that whole life cycle costs are considered in the selection and design of storm water management features and that a source of funding is provided for long-term maintenance.
- Identify the party responsible for inspecting structural BMPs at each significant construction stage and at completion to provide certification of structural BMPs following construction.

Planner:

- Communicate overall project planning criteria to the team, such as planned development density, parking requirements, project-specific planning conditions, conditions of approval from prior entitlement actions (e.g., CEQA, 401 certifications), and locations of open space and environmentally sensitive areas that are protected from disturbance (e.g., the least tern nesting area in the southwestern corner of SAN).
- Consider locations of storm water facilities early in the conceptual site layout process.
- Assist in developing the site plan.

Architect:

- Participate in siting and design (architectural elements) of storm water BMPs.

Civil Engineer:

- Determine storm water requirements applicable to the site (e.g., Standard Project versus PDP).
- Obtain site-specific information (e.g., watershed information, infiltration rates) and develop viable storm water management options that meet project requirements.

Chapter 3: Development Project Planning and Design

- Reconcile storm water management requirements with other site requirements (e.g., fire access, Americans with Disabilities Act accessibility, parking, open space).
- Develop site layout and site design, including preliminary and final design documents or plans.
- Select and design BMPs; conduct and document associated analyses; and prepare BMP design sheets, details, and specifications.
- Prepare project SWQMP submittals.

Landscape Architect and/or Horticulturist/Agronomist:

- Select appropriate plants for vegetated storm water features and BMPs and prepare planting plans.
- Develop specifications for planting, vegetation establishment, and maintenance.
- Assist in developing irrigation plans/rates to minimize water application and non-storm water runoff from the project site.

Geotechnical Engineer

- Assist in preliminary infiltration feasibility screening of the site to help inform project layout and initial BMP selection, including characterizing soil, groundwater, geotechnical hazards, utilities, and any other factors applicable for the site.
- Conduct detailed analyses at proposed infiltration BMP locations to confirm or revise feasibility findings and provide design infiltration rates.
- Provide recommendations for infiltration testing that must be conducted during the construction phase, if needed to confirm pre-construction infiltration estimates.

3.2 Gathering Project Site Information

To make decisions related to selection and design of storm water management BMPs, it is necessary to gather relevant project site information, including physical site information, proposed uses of the site, level of storm water management requirements (i.e., determination of whether it is a Standard Project or a PDP), proposed storm water discharge locations, potential/anticipated storm water pollutants based on the proposed uses of the site, receiving water sensitivity to pollutants and susceptibility to erosion, and other site requirements and constraints.

The amount and type of information that should be collected depend on the project type (i.e., whether it is a Standard Project or a PDP with pollutant control requirements). Refer to Figure 1-1 in Chapter 1 to identify the project type.

Information should be gathered only to the extent necessary to inform the storm water management design. In some cases, it is not necessary to conduct site-specific analyses to precisely characterize conditions. For example, if depth to groundwater is known to be approximately 100 feet based on regional surveys, it is not necessary to also conduct a site-specific assessment of depth to groundwater to determine whether the depth is 90 feet or 110 feet on the project site. The difference between these values would not influence the storm water management design. In other cases, some information is not applicable. For example, on an existing development site, there may be no natural hydrologic

features remaining; therefore, these features do not need to be characterized. The lack of natural hydrologic features can be simply noted without further effort required.

Submittal templates (in Appendix A) are provided to facilitate gathering information about the project site for BMP selection and design. The checklists in Appendix H may also be necessary, depending on the type of BMP selected. As part of planning for the site investigation, it is helpful to review the subsequent steps (Sections 3.3 and 3.4) to gain familiarity with how the site information will be used in making decisions about site layout and storm water BMP selection and design. This can help prioritize the data that are collected.

3.3 Developing Conceptual Site Layout and Storm Water Control Strategies

Once preliminary site information has been obtained, the site can be assessed for storm water management opportunities and constraints that inform the overall site layout. Considering the project site data discussed above, it is essential to identify potential locations for storm water management features at a conceptual level during the site planning phase. Storm water management requirements must be considered a key factor in laying out the overall site. Preliminary design of permanent storm water BMPs is partially influenced by whether the project is a Standard Project or a PDP. Table 3-1 presents the applicability of different subsections in this Manual based on project type and must be used to determine which requirements apply to a given project.

TABLE 3-1. Applicability of Section 3.3 Subsections for Different Project Types

Project Type	Section 3.3.1	Section 3.3.2	Section 3.3.3	Section 3.3.4
Standard Project	☑	NA	NA	NA
PDP With Only Pollutant Control Requirements	☑	NA	☑	☑
PDP With Pollutant and Hydromodification Management Requirements	Requirements not applicable to Authority projects.			

3.3.1 Preliminary Design Steps for All Development Projects

All projects must incorporate source control and site design BMPs. The following systematic approach outlines these site planning considerations for all development projects:

- 1) Review Chapter 4 to become familiar with the menu of source control and site design practices that are required.
- 2) Review the preliminary site information gathered in Section 3.2, specifically related to:
 - a) Natural hydrologic features that can be preserved and/or protected;
 - b) Soil information;

Chapter 3: Development Project Planning and Design

- c) General drainage patterns (i.e., general topography, points of connection to the storm drain or receiving water);
 - d) Pollutant sources that require source controls; and
 - e) Information gathered and summarized in the Site Information Checklist for Standard Projects (Appendix A.3).
- 3) Create opportunities for source control and site design BMPs by developing an overall conceptual site layout that allocates space for site design BMPs and promotes drainage patterns that are effective for hydrologic control and pollutant source control. For example:
 - a) Locate pervious areas down gradient from buildings where possible to allow for dispersion.
 - b) Identify parts of the project that could be drained via overland vegetated conveyance rather than piped connections.
 - c) Develop traffic circulation patterns that are compatible with minimizing street widths.
 - 4) As part of Section 3.4, refine the selection and placement of source control and site design BMPs and incorporate them into project plans. Compliance with site design and source control requirements shall be documented as described in Chapter 4.

3.3.2 Evaluation of Critical Coarse Sediment Yield Areas

For PDPs that are required to meet hydromodification management requirements, the potential presence of critical coarse sediment yield areas exist within or upstream of the project site is to be evaluated. However, this requirement does not apply to Authority projects, because all runoff from SAN discharges directly to an enclosed embayment and is exempt from hydromodification management requirements.

3.3.3 Drainage Management Areas

Drainage management areas (DMAs) provide an important framework for feasibility screening, BMP prioritization, and storm water management system configuration. BMP selection, sizing, and feasibility determinations must be made at the DMA level; therefore, delineation of DMAs is highly recommended at the conceptual site planning phase and is mandatory for completing the project design and meeting submittal requirements. This section provides guidance on delineating DMAs that is intended to be used as part of Sections 3.3 and 3.4.

Definitions of DMAs are based on the proposed drainage patterns of the site and the BMPs to which they drain. During the early phases of the project, DMAs shall be delineated based on onsite drainage patterns and possible BMP locations identified in the site planning process. DMAs should not overlap and should be similar with respect to BMP opportunities and feasibility constraints. More than one DMA can drain to the same BMP. However, because the BMP sizes are determined by the runoff from the DMA, a single DMA may not drain to more than one BMP. See Figure 3-2.

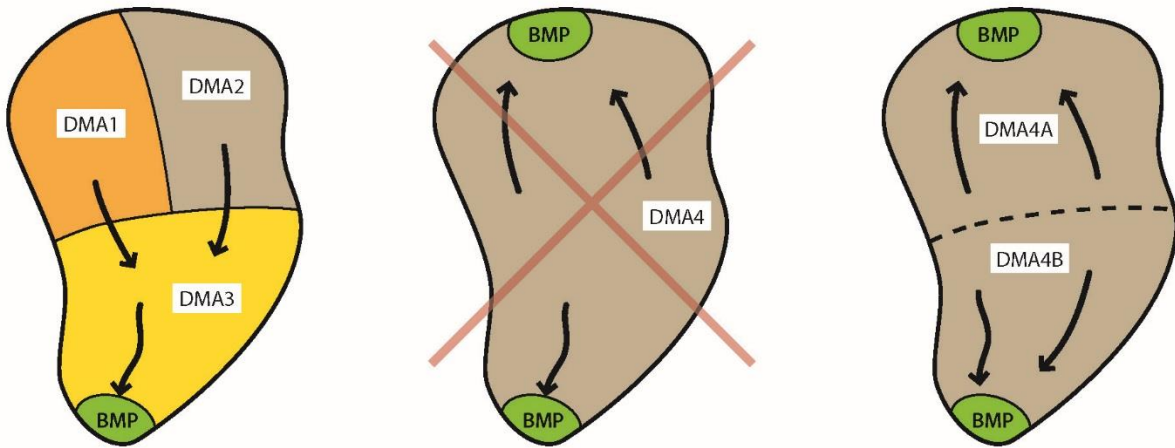

FIGURE 3-2. DMA Delineation

In some cases, in early planning phases, it may be appropriate to generalize the proposed treatment plan by simply assigning a certain BMP type to an entire planning area (e.g., Parking lot X will be treated with bioretention) and calculating the total sizing requirement without identifying the specific BMP locations at that time. This planning area would be later subdivided for design-level calculations. Section 5.2 provides additional guidance on DMA delineation. A runoff factor (such as a “C” factor used in the rational method) should be used to estimate the runoff draining to the BMP. Appendix B.1 provides guidance in estimating the runoff factor for the drainage area draining to a BMP.

BMPs must be sized to treat the DCV from the total area draining to the BMP, including any offsite or onsite areas that comingle with project runoff and drains to the BMP. To minimize offsite flows treated by project BMPs, consider diverting upgradient flows subject to local drainage and flood control regulation. An example is shown in Figure 3-3.

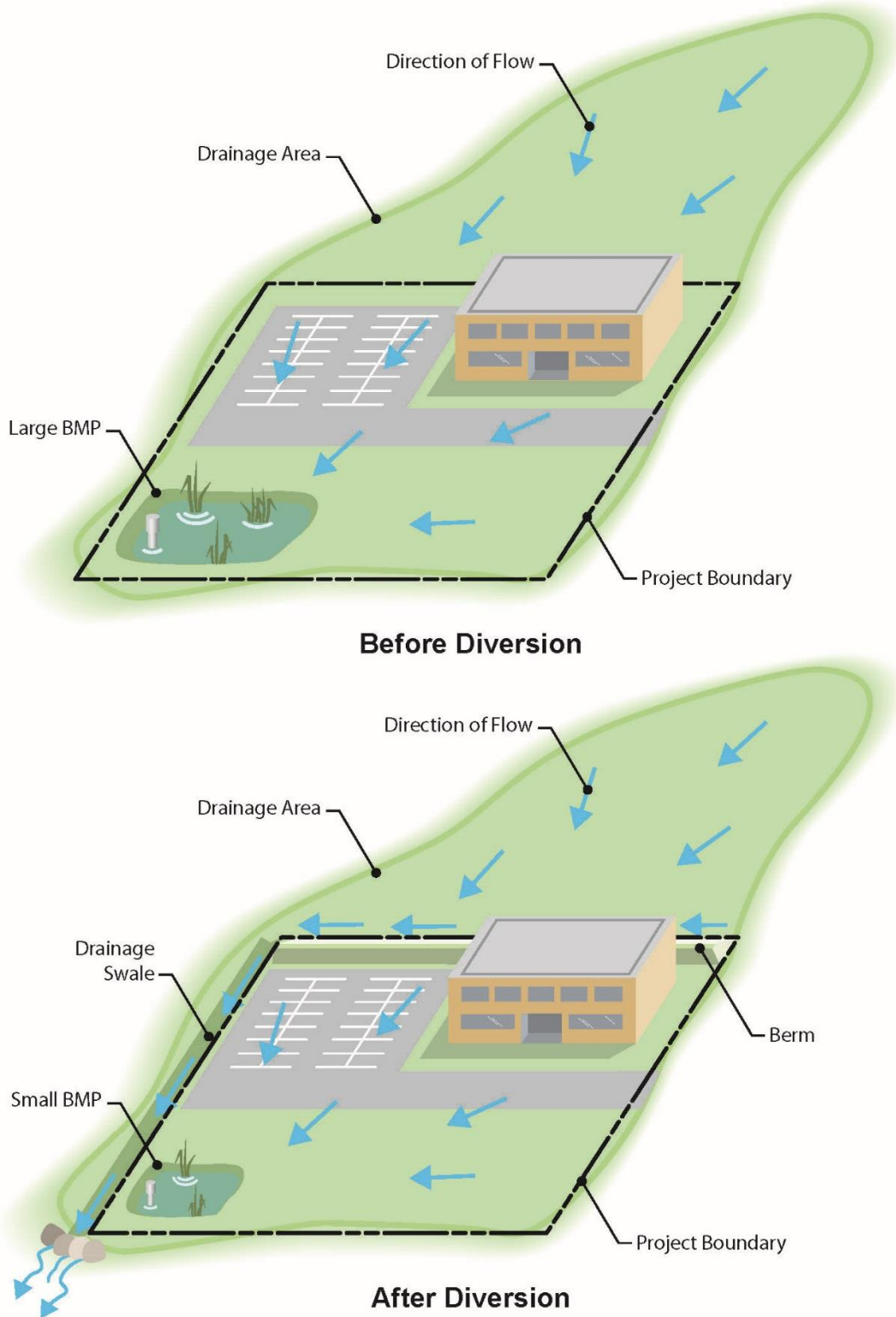

FIGURE 3-3. Tributary Area for BMP Sizing

3.3.4 Developing Conceptual Storm Water Control Strategies

This step applies to PDPs only. The goal of this step is to develop conceptual storm water control strategies that are compatible with the site conditions, including siting and preliminary selection of structural BMPs. At this phase of project planning, it is typically still possible for storm water considerations to influence the site layout to better accommodate storm water design requirements. The product of this step should be a general, but concrete, understanding of the storm water management parameters for each DMA, the compatibility of this approach with the site design, and preliminary estimates of BMP selection. For simpler sites, this step could be abbreviated in favor of skipping forward to design-level analyses in Section 3.4. However, for larger and/or more complex sites, this section can provide considerable value and can help evaluation of storm water management requirements on common ground with other site planning considerations.

The following systematic approach is recommended:

- 1) Review the preliminary site information gathered in Section 3.2, specifically related to information gathered and summarized in the Site Information Checklist for PDPs (Appendix A.4).
- 2) Identify self-mitigating, de minimis areas, and/or potential self-retaining DMAs that can be isolated from the remainder of the site (see Section 5.2).
- 3) Estimate the DCV for each remaining DMAs (see Appendix B.1).
- 4) Determine whether there is a potential opportunity for harvest and use (HU) of storm water from the project site. See Section 5.4.1 for harvest and use feasibility screening, which is based on water demand at the project site. For most sites, there is limited opportunity; therefore, evaluating this factor early can help simplify later decisions.
- 5) Estimate potential runoff reduction and the DCV that could be achieved with site design BMPs (see Section 5.3 and Appendix B.2) and harvest and use BMPs (see Appendix B.3).
- 6) Based on the remaining runoff after accounting for Steps 2 through 5, estimate BMP space requirements. Identify applicable structural BMP requirements (i.e., storm water pollutant control) and conduct approximate sizing calculations to determine the overall amount of storage volume and/or footprint area required for BMPs. Use the worksheets in Appendices B.4 and B.5 to estimate sizing requirements for different types of BMPs.
- 7) Conduct a preliminary screening of infiltration feasibility conditions as part of site planning to identify areas that are conducive to infiltration. Recommended factors to consider include the following:
 - a) Soil types (determined from available geotechnical testing data, soil maps, site observations, and/or other data sources),
 - b) Approximate infiltration rates at various points on the site, obtained via approximate methods (e.g., simple pit test), if practicable,
 - c) Groundwater elevations,
 - d) Proposed depths of fill,
 - e) New or existing utilities that will remain with development,
 - f) Soil or groundwater contamination issues within the site or in the vicinity of the site,

Chapter 3: Development Project Planning and Design

- g) Slopes and other potential geotechnical hazards that are unavoidable as part of site development, and
- h) Safety and accessibility considerations.

This assessment is not intended to be final or to account for all potential factors. Rather, it is intended to help identify site opportunities and constraints as they relate to site planning. After potential BMP locations are established, a more detailed feasibility analysis is necessary (see Sections 3.4 and 5.4.2). Additionally, Appendices C and D provide methods for geotechnical and groundwater assessment applicable for screening at the planning level and design level. The jurisdiction may allow alternate assessment methods with appropriate documentation at the discretion of P&EAD.

- 8) Identify tentative BMP locations based on preliminary feasibility screening, natural opportunities for BMPs (e.g., low areas of the site, areas near storm drain or stream connections), and other BMP sites that can potentially be created through effective site design (e.g., oddly configured or otherwise unbuildable parcels, easements, and landscape amenities, including open space and buffers that can double as locations for bioretention or biofiltration facilities).
- 9) Determine tentative BMP feasibility categories for infiltration for each DMA or specific BMP location. Based on the results of feasibility screening and tentative BMP locations, determine the general feasibility categories that would apply to BMPs in these locations. Categories are described in Section 5.4.2 and include the following:
 - a) Full infiltration condition;
 - b) Partial infiltration condition; and
 - c) No infiltration condition.

Adapt the site layout to attempt to achieve infiltration to the greatest extent feasible.

- 10) Consider how storm water management BMPs will be accessed for inspection and maintenance and provide necessary site planning allowances (access roads, inspection openings, setbacks, etc.).
- 11) Document site planning and opportunity assessment activities as a record of the decisions that led to the development of the final storm water management plan. The SWQMP primarily shows the complete design rather than the preliminary steps in the process. However, to comply with the requirements of this Manual, the applicant is required to describe how storm water management objectives have been considered as early as possible in the site planning process and how opportunities to incorporate BMPs have been identified.

3.4 Developing Complete Storm Water Management Design

The complete storm water management design consists of all the elements describing the BMPs to be implemented, as well as integration of the BMPs with the site design and other infrastructure. The storm water management design shall be developed by taking into consideration the opportunities and/or constraints identified during the site planning phase of the project and then performing the final design level analysis. The scope of this step varies depending on whether the project is a Standard

Chapter 3: Development Project Planning and Design

Project or a PDP with pollutant control BMP requirements. The following systematic approach is recommended to develop a final site layout and storm water management design. Table 3-2 presents the applicability of different Manual subsections based on project type and must be used to determine which requirements apply to a given project.

TABLE 3-2. Applicability of Section 3.4 Subsections for Different Project Types

Project Type	Section 3.4.1	Section 3.4.2	Section 3.4.3
Standard Project	<input checked="" type="checkbox"/>	NA	NA
PDP With Only Pollutant Control Requirements	<input checked="" type="checkbox"/>	<input checked="" type="checkbox"/>	NA
PDP With Pollutant Control and Hydromodification Management Requirements	Requirements do not apply to Authority projects.		

3.4.1 Steps for All Development Projects

Standard Projects need to satisfy only the source control and site design requirements of Chapter 4, and then proceed to Chapter 8 to determine submittal requirements:

- 1) Select, identify, and detail specific source control BMPs. See Section 4.2.
- 2) Select, identify, and detail specific site design BMPs. See Section 4.3.
- 3) Document that all applicable source control and site design BMPs have been used. See Chapter 8.

3.4.2 Steps for PDPs With Only Pollutant Control Requirements

The following steps primarily consist of refinements to the conceptual steps completed as part of Section 3.3, accompanied by design-level detail and calculations. More detailed instructions for selection and design of storm water pollutant treatment BMPs are provided in Chapter 5:

- 1) Select locations for storm water pollutant control BMPs and delineate and characterize DMAs using information gathered during the site planning phase.
- 2) Conduct a feasibility analysis for harvest and use BMPs. See Section 5.4.1.
- 3) Conduct a feasibility analysis for infiltration to determine the infiltration condition. See Section 5.4.2.
- 4) Based on the results of Steps 2 and 3, select the BMP category that is most appropriate for the site. See Section 5.5.
- 5) Calculate required BMP sizes and footprints. See Appendix B (sizing methods) and Appendix E (design fact sheets).
- 6) Evaluate whether the required BMP footprints will fit within the site, considering the site constraints; if not, then document infeasibility and move to the next step.

Chapter 3: Development Project Planning and Design

- 7) If using biofiltration BMPs, document conformance with the criteria for the biofiltration BMPs in Appendix F, including Appendix F.1, as applicable.
- 8) If needed, implement flow-through treatment control BMPs (for use with alternative compliance) for the remaining DCV. See Section 5.5.4 and Appendix B.6 for additional guidance.
- 9) If flow-through treatment control BMPs (for use with alternative compliance) were implemented, refer to Section 1.8.
- 10) Prepare a SWQMP documenting site planning and opportunity assessment activities, final site layout, and storm water management design. See Chapter 8.
- 11) Determine and document O&M requirements. See Chapters 7 and 8.

3.4.3 Steps for Projects With Pollutant Control and Hydromodification Management Requirements

The steps to consider when hydromodification management is required primarily consist of refinements to the conceptual steps completed as part of Section 3.3, accompanied by design-level detail and calculations. However, hydromodification management is not a requirement of Authority projects because all runoff from SAN drains directly to an enclosed embayment.

3.5 Project Planning and Design Requirements Specific to the Authority

It should be decided during initial project design whether FMD, SAN tenants, site operators, or another entity will be responsible for maintaining the selected structural BMPs for PDPs. Although the Authority is responsible for overall operation of SAN, certain areas are operated by tenants under short- and long-term leases. Tenants may be responsible for maintenance of BMPs within their operational areas, as designated on their lease agreement. The Authority retains ultimate responsibility for oversight and enforcement of maintenance activities, and may levy penalties, including fines, to compel compliance with maintenance requirements. During project design, project proponents should consult with P&EAD to determine the appropriate responsible party for maintenance.

3.6 Phased Projects

Phased projects typically require a conceptual or master PDP SWQMP followed by more detailed submittals.

For phased projects, P&EAD may request a conceptual or master SWQMP that describes and illustrates, in broad outline, how the drainage for the project will comply with Manual requirements. The level of detail in the conceptual or master SWQMP should be consistent with the scope and level of detail of the development approval being considered. The conceptual or master SWQMP should specify that a more detailed SWQMP for each later phase or portion of the project will be submitted with subsequent applications for approval of various project components.

Chapter 3: Development Project Planning and Design

As stated in Section 1.3, a project may not be segmented or phased into small parts either onsite or offsite if the effect is to reduce the quantity of impervious area and fall below thresholds for applicability of storm water requirements. Phased projects must consider the total area of new or replaced impervious surface, and applicants cannot phase work to evade PDP requirements.

Source Control and Site Design Requirements for All Development Projects

This chapter presents the source control and site design requirements to be met by all projects, including Standard Projects and PDPs. Checklists H-4 for source control and H-5 for site design included in Appendix A can be used by both Standard Projects and PDPs to document conformance with the requirements.

4.1 General Requirements (GRs)

GR-1: Onsite BMPs must be located to remove pollutants from runoff prior to its discharge to any receiving waters, and as close to the source as possible.

The location of the BMP affects the ability of the BMP to retain, and/or treat, the pollutants from the contributing drainage area. BMPs must remove pollutants from runoff and should be placed as close to the pollutant source as possible.

How to comply: Projects shall comply with this requirement by implementing source control (Section 4.2) and site design BMPs (Section 4.3) that are applicable to their project and site conditions.

GR-2: Structural BMPs must not be constructed within the waters of the U.S.

Construction, operation, and maintenance of a structural BMP in a water body can negatively impact the physical, chemical, and biological integrity, as well as the beneficial uses, of the water body. However, alternative compliance opportunities involving restoration of areas within Waters of the U.S. may be identified by the Authority.

How to comply: Projects shall comply with this requirement by preparing project plans that illustrate the locations of all storm water BMPs and describe or depict the location of receiving waters.

GR-3: Onsite BMPs must be designed and implemented with measures to avoid the creation of nuisances or pollutions associated with vectors (e.g., mosquitoes, rodents, or flies).

According to the California Department of Health, structural BMPs that retain standing water for more than 96 hours are particularly concerning for facilitating mosquito breeding. Certain site design features that hold standing water may similarly produce mosquitoes.

Chapter 4: Source Control and Site Design Requirements for All Development Projects

How to comply: Projects shall comply with this requirement by incorporating design, construction, and maintenance principles to drain retained water within **96 hours** and minimize standing water. Design calculations shall be provided to demonstrate that the potential for standing water ponding at surface level and accessible to mosquitoes has been addressed. For water retained in biofiltration facilities that are not accessible to mosquitoes, this criterion is not applicable (i.e., water ponding in the gravel layer, water retained in the amended soil, etc.).

4.2 Source Control (SC) BMP Requirements

Source control BMPs avoid and reduce pollutants in storm water runoff. Everyday activities, such as recycling, trash disposal, and irrigation, generate pollutants that have the potential to drain to the storm water conveyance system. A source control BMP is defined as an activity that reduces the potential for storm water runoff to come into contact with pollutants. An activity could include an administrative action, design of a structural facility, use of alternative materials, and operation, maintenance, and inspection of an area.

Where applicable and feasible, all development projects are required to implement source control BMPs. Source control BMPs required by the MS4 Permit (SC-1 through SC-6) are discussed in this section. These correspond to existing source control BMPs required by the Authority in the Authority SWMP; the corresponding Authority BMP numbering is noted in the discussion of each BMP. Additional source control BMPs may be required by the Authority, depending on project type. The full list of Authority source control BMPs is provided in Appendix B of the Authority SWMP.

How to comply: Projects shall comply with this requirement by implementing source control BMPs listed in this section that are applicable to their project. Applicability shall be determined through consideration of the development project's features and anticipated pollutant sources. Appendix E provides guidance for identifying source control BMPs applicable to a project. The "Source Control BMP Checklist for All Development Projects" in Appendix A.3 for Standard Projects and Appendix A.4 for PDPs shall be used to document compliance with source control BMP requirements.

SC-1: Prevent illicit discharges into the MS4

An illicit discharge is any discharge to the MS4 that is not composed entirely of storm water, except discharges pursuant to a NPDES permit and discharges resulting from firefighting activities. Projects must effectively eliminate discharges of non-storm water into the MS4. This may involve a suite of housekeeping BMPs that could include effective irrigation, dispersion of non-storm water discharges into landscaping for infiltration, and control of wash water from vehicle washing. This BMP corresponds to Authority BMPs SC01 (Non-Storm Water Management), SC04 (Aircraft, Ground Vehicle, and Equipment Cleaning), SC05 (Aircraft Deicing/Anti-Icing), SC09 (Building and Grounds Maintenance), SC11 (Lavatory Service Operation), SC12 (Outdoor Washdown/Sweeping), SC13 (Fire Fighting Foam Discharge), SC14 (Potable Water System Flushing), SC15 (Runway Rubber Removal), SC18 (Housekeeping), SC20 (Erodible Areas), SC21 (Building Repair and Construction), and SR01 (Spill Prevention, Control, and Clean-Up). Authority BMPs are presented in detail in Appendix B of the Authority SWMP.

SC-2: Identify the storm drain system using stenciling or signage

Storm drain signs and stencils are visible source controls typically placed adjacent to the inlets. Posting notices regarding discharge prohibitions at storm drain inlets can prevent waste dumping. Stenciling shall be provided for all storm water conveyance system inlets and catch basins within the project area. Inlet stenciling may include concrete stamping, concrete painting, placards, or other methods

Chapter 4: Source Control and Site Design Requirements for All Development Projects

approved by the Authority. In addition to storm drain stenciling, projects are encouraged to post signs and prohibitive language (with graphical icons) that prohibit illegal dumping at building entrances and public access points within the project area. This BMP corresponds to Authority BMPs SC01 (Non-Storm Water Management) and SC17 (Storm Drain Maintenance).

Language associated with the stamping will include the words “No Dumping! Flows to Bay” or similar as approved by the P&EAD.

SC-3: Protect outdoor material storage areas from rainfall, run-on, runoff, and wind dispersal

Materials with the potential to pollute storm water runoff shall be stored in a manner that prevents contact with rainfall and storm water runoff. Contaminated runoff shall be managed for treatment and disposal (e.g., secondary containment directed to sanitary sewer). All development projects shall incorporate the following structural or pollutant control BMPs for outdoor material storage areas, as applicable and feasible:

- Materials with the potential to contaminate storm water shall be:
 - Placed in an enclosure such as, but not limited to, a cabinet, or similar structure, or under a roof or awning that prevents contact with rainfall runoff or spillage to the storm water conveyance system; or
 - Protected by secondary containment structures such as berms, dikes, or curbs.
- The storage areas shall be paved and sufficiently impervious to contain leaks and spills, where necessary.
- The storage area shall be sloped toward a sump or another equivalent measure that is effective to contain spills.
- Runoff from downspouts/roofs shall be directed away from storage areas.
- The storage area shall have a roof or awning that extends beyond the storage area to minimize collection of storm water within the secondary containment area. A manufactured storage shed may be used for small containers.

This BMP corresponds to Authority BMPs SC07 (Outdoor Material Storage) and SC21 (Building Repair and Construction). Authority BMPs are presented in detail in Appendix B of the Authority SWMP.

SC-4: Protect materials stored in outdoor work areas from rainfall, run-on, runoff, and wind dispersal

Outdoor work areas have an elevated potential for pollutant loading and spills. All development projects shall include the following structural or pollutant control BMPs for any outdoor work areas with potential for pollutant generation, as applicable and feasible:

- Create an impermeable surface such as concrete or asphalt, or a prefabricated metal drip pan, depending on the size needed to protect the materials.
- Cover the area with a roof or other acceptable cover.
- Berm the perimeter of the area to prevent water from adjacent areas from flowing on to the surface of the work area.

Chapter 4: Source Control and Site Design Requirements for All Development Projects

- Directly connect runoff to sanitary sewer or other specialized containment system(s), as needed and where feasible. This allows the more highly concentrated pollutants from these areas to receive special treatment that removes particular constituents. Approval for this connection must be obtained from the appropriate sanitary sewer agency.
- Locate the work area away from storm drains or catch basins.

This BMP corresponds to Authority BMPs SC02A (Outdoor Equipment Operations and Maintenance Areas), SC02B (Aircraft, Ground Vehicle, and Equipment Maintenance), SC02C (Electric Vehicle Maintenance), SC03 (Aircraft, Ground Vehicle, and Equipment Fueling), SC06 (Outdoor Loading/Unloading of Materials), SC09 (Building and Grounds Maintenance), and SC21 (Construction and Remodeling/Repair). Authority BMPs are presented in detail in Appendix B of the Authority SWMP.

SC-5: Protect trash storage areas from rainfall, run-on, runoff, and wind dispersal

Storm water runoff from areas where trash is stored or disposed of can be polluted. In addition, loose trash and debris can be easily transported by water or wind into nearby storm drain inlets, channels, and/or creeks. All development projects shall include the following structural or pollutant control BMPs, as applicable:

- Design trash container areas so that drainage from adjoining roofs and pavement is diverted around the area(s) to avoid run-on. This can include berming or grading the waste handling area to prevent run-on of storm water.
- Ensure that trash container areas are screened or walled to prevent offsite transport of trash.
- Provide roofs, awnings, or attached lids on all trash containers to minimize direct precipitation and prevent rainfall from entering containers.
- Locate storm drains away from the vicinity of the trash storage area and vice versa.
- Post signs on all dumpsters to inform users that hazardous materials are not to be disposed of.

This BMP corresponds to Authority BMP SC08 (Waste Handling and Disposal). Authority BMPs are presented in detail in Appendix B of the Authority SWMP.

SC-6: Use any additional BMPs determined to be necessary by the Authority to minimize pollutant generation at each project site

Appendix E provides guidance on permanent controls and operational BMPs that are applicable at a project site based on potential sources of runoff pollutants at the project site. The applicant shall implement all applicable and feasible source control BMPs listed in Appendix E.

The full list of Authority source control BMPs is provided in Appendix B of the Authority SWMP (www.san.org/green). The following source control BMPs may apply, depending on project type:

- 1) SC01 – Non-Storm Water Management
- 2) SC02A – Outdoor Equipment Operations and Maintenance Areas
- 3) SC02B – Aircraft, Ground Vehicle, and Equipment Preventive Maintenance

Chapter 4: Source Control and Site Design Requirements for All Development Projects

- 4) SC02C – Electric Vehicle Maintenance
- 5) SC03 – Aircraft, Ground Vehicle, and Equipment Fueling
- 6) SC04 – Aircraft, Ground Vehicle, and Equipment Cleaning
- 7) SC05 – Aircraft Deicing/Anti-Icing
- 8) SC06 – Outdoor Loading/Unloading of Materials
- 9) SC07 – Outdoor Material Storage
- 10) SC08 – Waste Handling and Disposal
- 11) SC09 – Building and Grounds Maintenance
- 12) SC10 – Employee Training
- 13) SC11 – Lavatory Service Operations
- 14) SC12 – Outdoor Washdown/Sweeping (Apron Washing, Ramp Scrubbing)
- 15) SC13 – Firefighting Foam Discharge
- 16) SC14 – Potable Water System Flushing
- 17) SC15 – Runway Rubber Removal
- 18) SC16 – Parking Lots
- 19) SC17 – Storm Drain Maintenance
- 20) SC18 – Good Housekeeping
- 21) SC19 – Safer/Alternative Products
- 22) SC20 – Erodible Areas
- 23) SC21 – Construction and Remodeling/Repair
- 24) SR01 – Spill Prevention, Control, and Clean-up
- 25) TC01 – Treatment Controls.

4.3 Site Design (SD) BMP Requirements

Site design BMPs (also referred to as LID BMPs) are intended to reduce the rate and volume of storm water runoff and associated pollutant loads. Site design BMPs include practices that reduce the rate and/or volume of storm water runoff by minimizing surface soil compaction, reducing impervious surfaces, and/or providing flow pathways that are “disconnected” from the storm drain system, such as by routing flow over pervious surfaces. Site design BMPs may incorporate interception, storage, evaporation, evapotranspiration, infiltration, and/or filtration processes to retain and/or treat pollutants in storm water before it is discharged from a site.

Site design BMPs shall be applied to all development projects as appropriate and practicable for the project site and project conditions. Site design BMPs are described in the following subsections.

Chapter 4: Source Control and Site Design Requirements for All Development Projects

Appendix E also provides the following fact sheets to assist applicants with the proper design of site design features:

- SD-A – Tree Wells
- SD-B – Impervious Area Dispersion
- SD-C – Green Roofs
- SD-D – Permeable Pavement (Site Design BMP)
- SD-E – Rain Barrels
- SD-F – Amended Soils

How to comply: Projects shall comply with this requirement by using all the site design BMPs listed in this section that are applicable and practicable to their project type and site conditions. Applicability of a given site design BMP shall be determined based on project type, soil conditions, presence of natural features (e.g., streams), and presence of site features (e.g., parking areas). Explanation shall be provided by the applicant when a certain site design BMP is not applicable or not practicable/feasible. Site plans shall show site design BMPs and provide adequate details necessary for effective implementation of site design BMPs. The "Site Design BMP Checklist for All Development Projects" in Appendix A.3 for Standard Projects and Appendix A.4 for PDPs shall be used to document compliance with site design BMP requirements. In some cases, implementation of site design BMPs may result in quantifiable reductions in the site's DCV (refer to Appendix B.2); however, failure to meet the minimum thresholds for DCV reductions does not eliminate requirements to implement applicable site design BMPs. All applicable and feasible site design BMPs must be implemented to the maximum extent practicable.

SD-1: Maintain natural drainage pathways and hydrologic features

- Maintain or restore natural storage reservoirs and drainage corridors (including topographic depressions, areas of permeable soils, natural swales, and ephemeral and intermittent streams).
- Include buffer zones for natural water bodies (where buffer zones are technically infeasible, include other buffers such as trees, access restrictions, etc.).

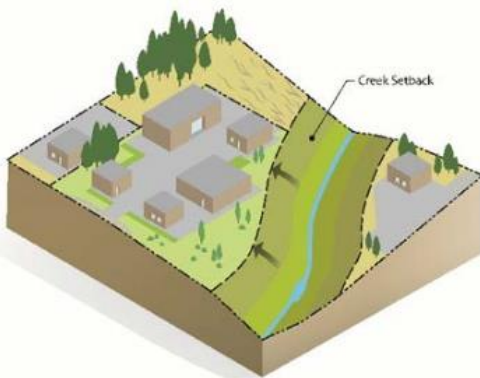

During the site assessment, natural drainages must be identified along with their connection to creeks and/or streams, if any. Natural drainages offer a benefit to storm water management as the soils and habitat already function as a natural filtering/infiltrating swale. When determining the development footprint of the site, avoid altering natural drainages. By providing a development envelope set back from natural drainages, the drainage can retain some water quality benefits to the watershed. In some situations, site constraints,

regulations, economics, or other factors may not allow drainages and sensitive areas to be avoided. Projects proposing to dredge or fill materials in Waters of the U.S. must obtain Clean Water Act Section 401 Water Quality Certification. Projects proposing to dredge or fill waters of the state must obtain waste discharge requirements. Both the Section 401 Certification and the Waste Discharge

Chapter 4: Source Control and Site Design Requirements for All Development Projects

Requirements are administered by the SDRWQCB. The project applicant shall consult P&EAD for other specific requirements.

Projects can incorporate SD-1 into a project by implementing the following planning and design phase techniques as applicable and practicable:

- Evaluate surface drainage and topography in considering selection of site design BMPs that are most beneficial for a given project site. Where feasible, maintain topographic depressions for infiltration.
- Optimize the site layout and reduce the need for grading. Where possible, conform the site layout along natural landforms, avoid grading and disturbance of vegetation and soils, and replicate the site's natural drainage patterns. Integrating existing drainage patterns into the site plan will help maintain the site's predevelopment hydrologic function.
- Preserve existing drainage paths and depressions, where feasible and applicable, to help maintain the time of concentration and infiltration rates of runoff and decrease peak flow.
- Do not use structural BMPs in buffer zones if a state and/or federal resource agency (e.g., SDRWQCB, California Department of Fish and Wildlife, United States Army Corps of Engineers, etc.) prohibits maintenance or activity in the area.

SD-2: Conserve natural areas, soils, and vegetation

- Conserve natural areas within the project footprint, including existing trees, other vegetation, and soils.

To enhance a site's ability to support source control and reduce runoff, the conservation and restoration of natural areas must be considered in the site design process. By conserving or restoring the natural drainage features, natural processes can intercept storm water, thereby reducing the amount of runoff. SAN is highly developed, and no natural areas exist; however, preservation of existing landscaped areas and the least tern nesting ovals should be considered in site design.

Chapter 4: Source Control and Site Design Requirements for All Development Projects

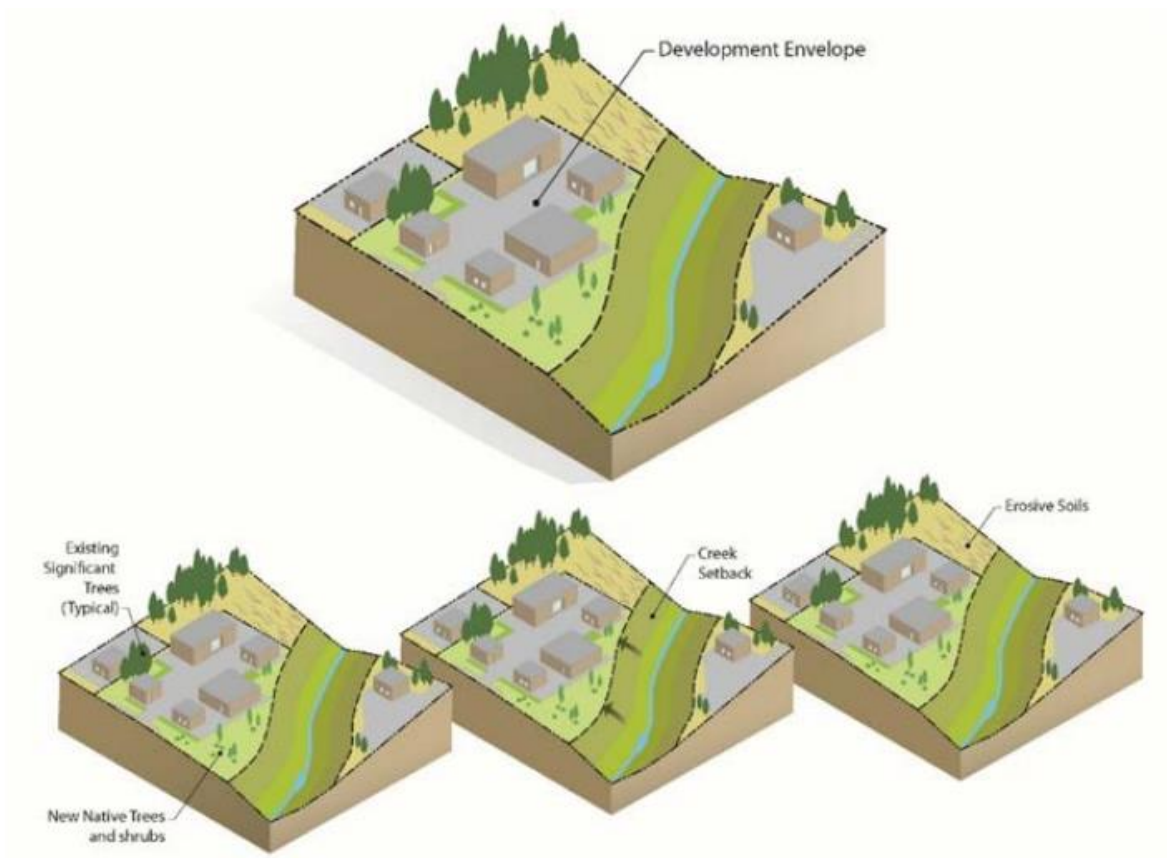

Source: County of San Diego LID Handbook

The upper soil layers of a natural area contain organic material, soil biota, vegetation, and a configuration favorable for storing and slowly conveying storm water and establishing or restoring vegetation to stabilize the site after construction. The canopy of existing native trees and shrubs also provides a water conservation benefit by intercepting rainwater before it reaches the ground. By minimizing disturbances in these areas, natural processes can intercept storm water, providing a water quality benefit. By keeping the development concentrated in the least environmentally sensitive areas of the site and set back from natural areas, storm water runoff is reduced, water quality can be improved, environmental impacts can be decreased, and many of the site's most attractive native landscape features can be retained. In some situations, site constraints, regulations, economics, and/or other factors may not allow avoidance of all sensitive areas on a project site. Project applicants shall consult P&EAD for specific requirements for mitigation of removal of sensitive areas.

Chapter 4: Source Control and Site Design Requirements for All Development Projects

Projects can incorporate SD-2 by implementing the following planning and design phase techniques as applicable and practicable:

- Identify areas most suitable for development and areas that should be left undisturbed. Additionally, disturbance can be reduced by increasing building density and increasing height, if possible.
- Cluster development on the least-sensitive portions of a site while leaving the remaining land in a natural undisturbed condition.
- Avoid areas with thick, undisturbed vegetation. Soils in these areas have a much higher capacity to store and infiltrate runoff than disturbed soils, and reestablishment of a mature vegetative community can take decades. Vegetative cover can also provide additional volume storage of rainfall by retaining water on the surfaces of leaves, branches, and trunks of trees during and after storm events.
- Preserve trees, especially native trees and shrubs, and identify locations for planting additional native or drought-tolerant trees (fact sheet SD-A Tree Well in Appendix E) and large shrubs. Refer to Appendix E for additional guidance on implementing SD-A Tree Wells as a site design BMP.
- In areas of disturbance, remove topsoil before construction and replace it after the project is completed. When implemented carefully, this approach limits the disturbance to native soils and reduces the need for additional (purchased) topsoil during later phases.
- Avoid sensitive areas, such as wetlands, biological open space areas, biological mitigation sites, streams, floodplains, or particular vegetation communities, such as coastal sage scrub and intact forest. Also, avoid areas that are habitat for sensitive plants and animals, particularly those state or federally listed as endangered, threatened, or rare (e.g., the least tern nesting ovals). Development in these areas is often restricted by federal, state, and local laws.

LEAST SENSITIVE



MOST SENSITIVE

1. AREAS DEVOID OF VEGETATION, INCLUDING PREVIOUSLY GRADED AREAS AND AGRICULTURAL FIELDS
2. AREAS OF NON-NATIVE VEGETATION, DISTURBED HABITATS AND EUCALYPTUS WOODLANDS WHERE RECEIVING WATERS ARE NOT PRESENT
3. AREAS OF CHAMISE OR MIXED CHAPARRAL, AND NON-NATIVE GRASSLANDS.
4. AREAS CONTAINING COASTAL SCRUB COMMUNITIES
5. ALL OTHER UPLAND COMMUNITIES
6. OCCUPIED HABITAT OF SENSITIVE SPECIES AND ALL WETLANDS (AS BOTH ARE DEFINED BY THE LOCAL JURISDICTION)

SD-3: Minimize impervious area

- Construct streets, sidewalks, or parking lot aisles to the minimum widths necessary, provided that public safety is not compromised.
- Minimize the impervious footprint of the project.

Chapter 4: Source Control and Site Design Requirements for All Development Projects

One of the principal causes of environmental impacts by development is the creation of impervious surfaces. Imperviousness links urban land development to degradation of aquatic ecosystems in two ways:

- First, the combination of paved surfaces and piped runoff efficiently collects urban pollutants and transports them, in suspended or dissolved form, to surface waters. These pollutants may originate as airborne dust and be washed from the atmosphere during rainfall or may be generated by automobiles and outdoor work activities.
- Second, increased peak flows and runoff durations typically erode stream banks and beds, transport fine sediments, and disrupt aquatic habitat. Measures taken to control stream erosion, such as hardening banks with riprap or concrete, may permanently eliminate habitat.

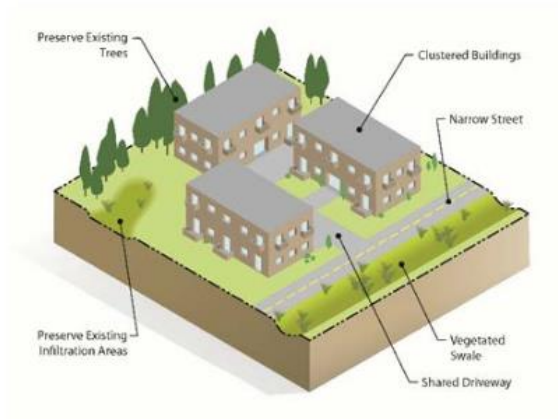

Impervious cover can be minimized by identifying the smallest possible land area that can be impacted or disturbed during site development. Reducing impervious surfaces retains the permeability of the project site, allowing natural processes to filter and reduce sources of pollution.

Projects can incorporate SD-3 by implementing the following planning and design phase techniques as applicable and practicable:

- Decrease building footprints through the design of compact and taller structures when allowed by Authority zoning and design standards and provided that public safety and flight security are not compromised.
- Construct walkways, trails, patios, overflow parking lots, alleys, and other low-traffic areas with permeable surfaces. Refer to Appendix E for additional guidance on implementing SD-D Permeable Pavement as a site design BMP.
- Construct streets, sidewalks, and parking lot aisles to the minimum widths necessary, provided that public safety and alternative transportation (e.g., pedestrians, bikes) are not compromised.
- Consider implementation of shared parking lots and driveways where possible.
- Landscaped areas in the center of a cul-de-sac, parking lot, or road can reduce impervious area, depending on configuration. Design of a landscaped cul-de-sac, parking lot, or road must be coordinated with fire department personnel to accommodate turning radii and other operational needs.
- Design smaller parking lots with fewer stalls, smaller stalls, and more efficient lanes.
- Design indoor or underground parking.
- Minimize the use of impervious surfaces in the landscape design.

Chapter 4: Source Control and Site Design Requirements for All Development Projects

SD-4: Minimize soil compaction

- Minimize soil compaction in landscaped areas

The upper soil layers contain organic material, soil biota, and a configuration favorable for storing and slowly conveying storm water downgradient. By protecting native soils and vegetation in appropriate areas during the clearing and grading phase of development, the site can retain some of its existing beneficial hydrologic function. Soil compaction resulting from the movement of heavy construction equipment can reduce soil infiltration rates. It is important to recognize that areas adjacent to and under building foundations, roads, and manufactured slopes must be compacted with minimum soil density requirements in compliance with local building and grading ordinances.

Projects can incorporate SD-4 by implementing the following planning and design phase techniques as applicable and practicable:

- Avoid disturbance in planned green space and proposed landscaped areas where feasible. These areas that are planned for retaining their beneficial hydrological function should be protected during the grading/construction phase so that vehicles and construction equipment do not intrude and inadvertently compact the area.
- In areas planned for landscaping where compaction cannot be avoided, re-till the soil surface to allow for better infiltration capacity. Soil amendments are recommended and may be necessary to increase permeability and organic content. Soil stability, density requirements, and other geotechnical considerations associated with soil compaction must be reviewed by a qualified landscape architect or licensed geotechnical, civil, or other professional engineer. Refer to the SD-F Amended Soils fact sheet in Appendix E for additional guidance on implementing amended soils within the project footprint.

SD-5: Disperse impervious areas

- Disconnect impervious surfaces through disturbed pervious areas.
- Design and construct landscaped or other pervious areas to effectively receive and infiltrate, retain and/or treat runoff from impervious areas prior to discharging to the MS4.

Impervious area dispersion (dispersion) refers to the practice of essentially disconnecting impervious areas from directly draining to the storm drain system by routing runoff from impervious areas such as rooftops, walkways, and roads onto the surface of adjacent pervious areas. The intent is to slow runoff discharges and reduce volumes while achieving incidental treatment. Volume reduction from dispersion is dependent on the infiltration characteristics of the pervious area and the amount of impervious area draining to the pervious area. Treatment is achieved through filtration, shallow sedimentation, sorption, infiltration, evapotranspiration, biochemical processes, and plant uptake.

The effects of imperviousness can be mitigated by disconnecting impervious areas from the drainage system and by encouraging detention and retention of runoff near the point where it is generated. Detention and retention of runoff reduce peak flows and volumes and allow pollutants to settle out or adhere to soils before they can be transported downstream. Disconnection practices may be applied in almost any location, but impervious surfaces must discharge into a suitable receiving area for the practices to be effective. Information gathered during the site assessment will help determine appropriate receiving areas.

Chapter 4: Source Control and Site Design Requirements for All Development Projects

Project designs should direct runoff from impervious areas to adjacent landscaping areas that have higher potential for infiltration and surface water storage to limit the amount of runoff generated and therefore the size of the mitigation BMPs downstream. The design, including consideration of slopes and soils, must reflect a reasonable expectation that runoff will soak into the soil and produce no runoff of the DCV. On hillside sites, drainage from upper areas may be collected in conventional catch basins and piped to landscaped areas that have higher potential for infiltration. Alternatively, low retaining walls can be used to create terraces that can accommodate BMPs.



Projects can incorporate SD-5 by implementing the following planning and design phase techniques as applicable and practicable:

- Implement design criteria and considerations listed in the fact sheet for SD-B Impervious Area Dispersion in Appendix E.
- Drain rooftops into adjacent landscape areas.
- Drain impervious parking lots, sidewalks, walkways, trails, and roads into adjacent landscape areas.
- Reduce or eliminate curb and gutters from roadway sections, thus allowing roadway runoff to drain to adjacent pervious areas.
- Replace curbs and gutters with roadside vegetated swales and direct runoff from the paved street or parking areas to adjacent LID facilities. This approach for alternative design can reduce the overall capital cost of the site development while improving the storm water quantity and quality issues and the site's aesthetics.
- Plan site layout and grading to allow for runoff from impervious surfaces to be directed into distributed permeable areas such as turf, landscaped or permeable recreational areas, medians, parking islands, planter boxes, etc.
- Detain and retain runoff throughout the site. On flatter sites, landscaped areas can be interspersed among the buildings and pavement areas. On hillside sites, drainage from upper

Chapter 4: Source Control and Site Design Requirements for All Development Projects

areas may be collected in conventional catch basins and conveyed to landscaped areas in lower areas of the site.

- Ensure that pervious areas that receive run-on from impervious surfaces shall have a minimum width of 10 feet and a maximum slope of 5 percent.

SD-6: Collect runoff

- Use small collection strategies located at, or as close to as possible to, the sources (i.e., the point where storm water initially meets the ground) to minimize the transport of runoff and pollutants to the MS4 and receiving waters.
- Use permeable materials for projects with low traffic areas and appropriate soil conditions. Refer to Appendix E for additional guidance on implementing INF-3 Permeable Pavement as a site design BMP.

Distributed control of storm water runoff from the site can be accomplished by applying small collection techniques (e.g., SD-C Green Roofs in Appendix E) or integrated management practices on small sub-catchments. Small collection techniques foster opportunities to maintain the natural hydrology and provide a much greater range of control practices. Integration of storm water management into landscape design and natural features of the site reduces site development and long-term maintenance costs and provides redundancy if one technique fails. On flatter sites, it typically works best to intersperse landscaped areas and integrate small-scale retention practices among the buildings and paved areas.

Permeable pavements contain small voids that allow water to pass through to a gravel base. They come in a variety of forms: modular paving systems (concrete pavers, grass-pave, or gravel-pave) or poured-in-place pavement (porous concrete, permeable asphalt). Project applicants should identify locations where permeable pavements could be substituted for impervious concrete or asphalt paving. The O&M of the site must ensure that permeable pavements are not sealed in the future. In areas where infiltration is not appropriate, permeable paving systems can be fitted with an under drain to allow filtration, storage, and evaporation prior to drainage into the storm drain system.

Projects can incorporate SD-6 by implementing the following planning and design phase techniques as applicable and practicable:

- Implement distributed small collection techniques to collect and retain runoff.
- Install permeable pavements (Fact Sheet SD-D Permeable Pavement in Appendix E).

SD-7: Landscape with native or drought-tolerant species

All development projects are required to select a landscape design and plant palette to minimize required resources (irrigation, fertilizers, pesticides) and pollutants generated from landscaped areas. Native plants require less use of fertilizers and pesticides because the plants are already adapted to the rainfall patterns and soils conditions. Plants should be selected to be drought tolerant and should not require watering after establishment (2 to 3 years). Watering should be required only during prolonged dry periods after plants are established. Final selection of plant material needs to be made by a landscape architect experienced with LID techniques. Microclimates vary significantly throughout the region, and consulting local municipal resources helps select plant materials suitable for a specific geographic location.

Chapter 4: Source Control and Site Design Requirements for All Development Projects

Projects can incorporate SD-7 by landscaping with native and drought-tolerant species. A recommended plant list is included in Appendix E (fact sheet Plant List (PL)).

SD-8: Harvest and use precipitation

Harvest and use BMPs capture and store storm water runoff for later use. Harvest and use can be applied at smaller scales (Standard Projects) using rain barrels or at larger scales (PDPs) using cisterns. This harvest and use technique has been successful in reducing runoff discharged to the storm drain system conserving potable water and recharging groundwater.

Rain barrels are aboveground storage vessels that capture runoff from roof downspouts during rain events and detain that runoff for later reuse for irrigating landscaped areas. The temporary storage of roof runoff reduces the runoff volume from a property and may reduce the peak runoff velocity for small, frequently occurring storms. In addition, by reducing the amount of storm water runoff that flows overland into a storm water conveyance system (storm drain inlets and drainpipes), less pollutant load is transported through the conveyance system into San Diego Bay. Reuse of the detained water for irrigation purposes leads to conservation of potable water and recharge of groundwater. The SD-E Rain Barrels and HU-1 Cistern fact sheets in Appendix E provide additional details for designing harvest and use BMPs. Projects can incorporate SD-8 by installing rain barrels or cisterns, as applicable.

Photograph Courtesy of Arid Solutions, Inc.



Storm Water Pollutant Control Requirements for PDPs

In addition to the site design and source control BMPs discussed in Chapter 4, PDPs are required to implement storm water pollutant control BMPs to reduce the quantity of pollutants in storm water discharges. Storm water pollutant control BMPs are engineered facilities that are designed to retain (i.e., intercept, store, infiltrate, evaporate, and evapotranspire), biofilter, and/or provide flow-through treatment of storm water runoff generated on the project site.

This chapter describes the specific process for determining which category of pollutant control BMP, or combination of BMPs, is most appropriate for the PDP site and how to design the BMP to meet the storm water pollutant control performance standard (per Section 2.2).

This chapter by itself is not a complete design guide for project development. It is intended to provide guidance for selecting and designing storm water pollutant control BMPs. Specifically:

- This chapter should be followed having conducted site planning that maximizes the opportunities for storm water retention and biofiltration discussed in Chapter 3.
- The steps in this chapter pertain specifically to storm water pollutant control BMPs. These criteria must be met regardless of whether or not hydromodification management applies; however, the overall sequencing of project development may be different if hydromodification applies (hydromodification requirements do not apply to Authority projects).

5.1 Steps for Selecting and Designing Storm Water Pollutant Control BMPs

Figures 5-1 and 5-2 present the flow chart for complying with storm water pollutant control BMP requirements. The steps associated with this flow chart are described in this section. A project is considered to comply with storm water pollutant control performance standards if it follows and implements this flow chart and follows the supporting technical guidance referenced from the flow chart.

This section is applicable whether or not hydromodification management requirements apply; however, the overall sequencing of project development may be different if hydromodification management requirements apply (hydromodification requirements do not apply to Authority projects).

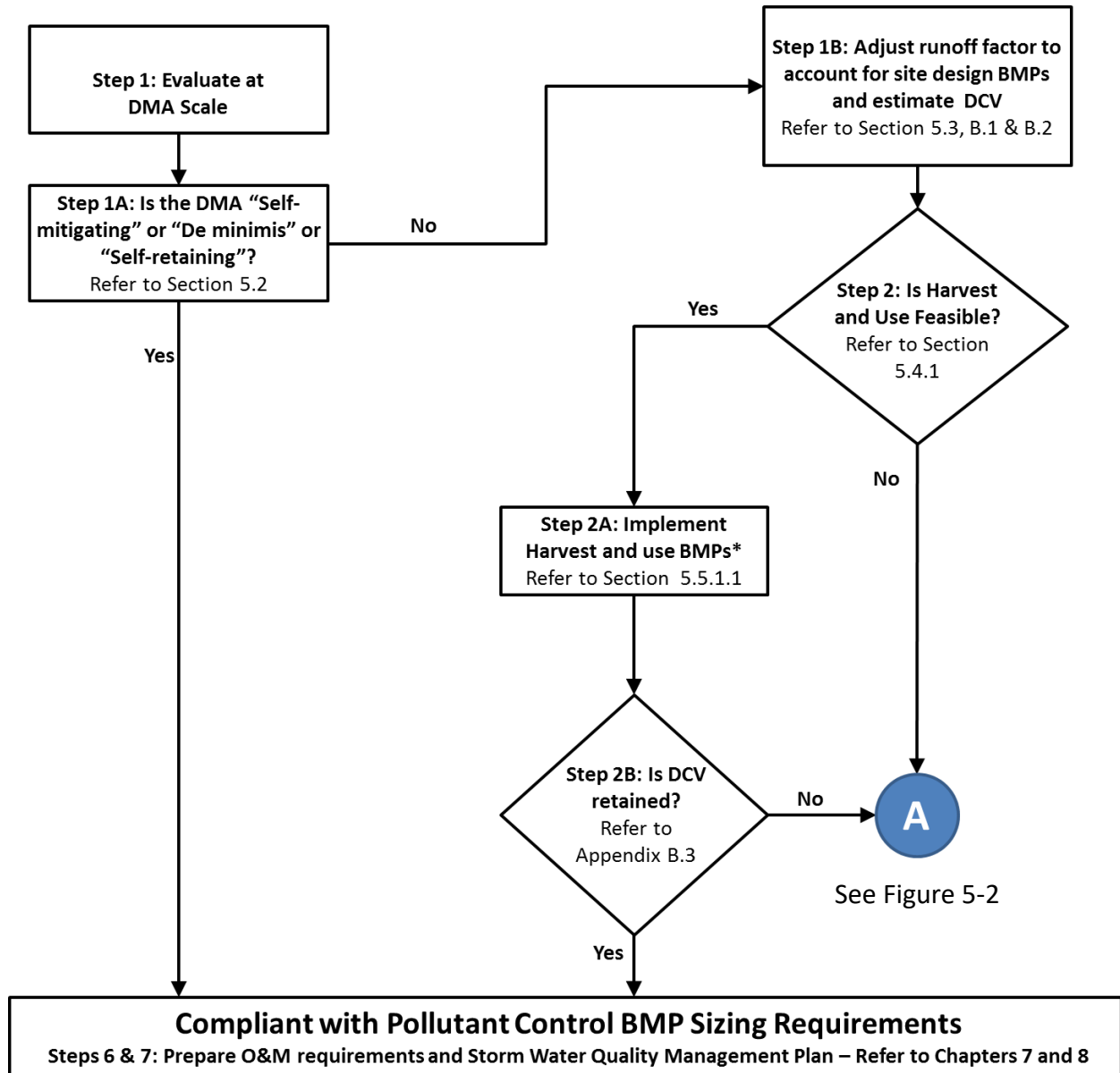

* Step 2C: Project applicant has an option to also conduct feasibility analysis for infiltration and if infiltration is fully or partially feasible has an option to choose between infiltration and harvest and use BMPs. But if infiltration is not feasible and harvest and use is feasible, project applicant must implement harvest and use BMPs

FIGURE 5-1. Storm Water Pollutant Control BMP Selection Flow Chart

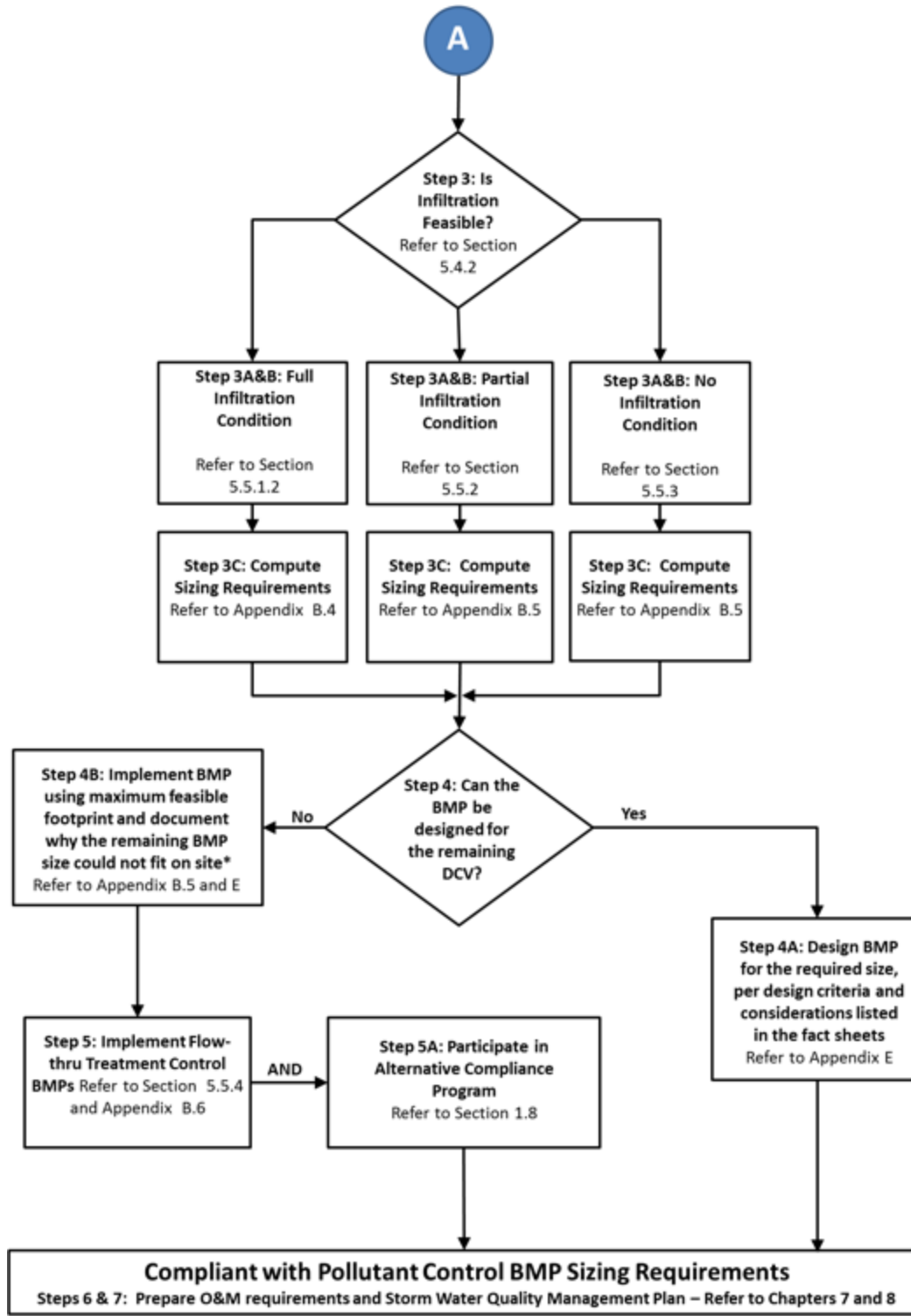

*Project approval at the discretion of P&EAD staff.

FIGURE 5-2. Storm Water Pollutant Control BMP Selection Flow Chart

Chapter 5: Storm Water Pollutant Control Requirements for PDPs

Description of Steps:

- Step 1. Based on the locations for storm water pollutant control BMPs and the DMA delineations developed during the site planning phase (See Section 3.3.3), calculate the DCV.
 - A. Identify DMAs that meet the criteria in Section 5.2 (self-mitigating and/or de minimis areas and/or self-retaining via qualifying site design BMPs).
 - B. Estimate the DCV for each remaining DMA. See Section 5.3.
- Step 2. Conduct a feasibility screening analysis for harvest and use BMPs. See Section 5.4.1.
 - A. If it is feasible, implement harvest and use BMPs (See Section 5.5.1.1) or go to Step 3.
 - B. Evaluate whether the DCV can be retained onsite using harvest and use BMPs. See Appendix B.3. If the DCV can be retained onsite, then the pollutant control performance standards are met.
 - C. (Optional): Conduct a feasibility analysis for infiltration, and if infiltration is feasible, choose infiltration or harvest and use BMPs. If the analysis finds that infiltration is not feasible and harvest and use is feasible, the applicant must implement harvest and use BMPs.
- Step 3. Conduct a feasibility analysis for infiltration for the BMP locations selected. See Section 5.4.2.
 - A. Determine the preliminary feasibility categories of BMP locations based on available site information. Determine the additional information needed to conclusively support findings. Use the "Categorization of Infiltration Feasibility Condition (H-8)" checklist located in Appendix H to conduct preliminary feasibility screening.
 - B. Select the storm water pollutant control BMP category based on the preliminary feasibility condition.
 - i. Full Infiltration Condition— Implement infiltration BMP category, See Section 5.5.1.2.
 - ii. Partial Infiltration Condition – Implement partial retention BMP category. See Section 5.5.2.
 - iii. No Infiltration Condition – Implement biofiltration BMP category. See Section 5.5.3.
 - C. After selecting BMPs, conduct design level feasibility analyses at BMP locations. The purpose of these analyses is to conform or adapt selected BMPs to maximize storm water retention and develop design parameters (e.g., infiltration rates, elevations). Document findings to substantiate BMP selection, feasibility, and design in the SWQMP. See Appendices C and D for additional guidance.
- Step 4. Evaluate whether the required BMP footprint will fit, considering the site design and constraints.
 - A. If the calculated footprint fits, then size and design the selected BMPs accordingly using design criteria and considerations from the fact sheets in Appendix E. The project has met the pollutant control performance standards.

Chapter 5: Storm Water Pollutant Control Requirements for PDPs

- B. If the calculated BMP footprint does not fit, evaluate additional options to make space for BMPs. Examples include revising potential designs, reconfiguring DMAs, evaluating other or additional BMP locations, and evaluating other BMP types. If no additional options are practicable for making adequate space for the BMPs, then document the reason that the remaining DCV could not be treated onsite and then implement the BMP using the maximum feasible footprint, design criteria, and considerations from the fact sheets in Appendix E. Then continue to the next step. If the entire DCV could not be treated because the BMP size could not fit within the project footprint, project approval is at the discretion of P&EAD.
- Step 5. Implement flow-through treatment control BMPs for the remaining DCV. See Section 5.5.4 and Appendix B.6 for additional guidance.
- A. When flow-through treatment control BMPs are implemented, participate in an ACP. See Section 1.8.
- Step 6. Prepare a SWQMP that documents site planning and opportunity assessment activities, final site layout, and storm water management design. See Chapter 8.
- Step 7. Identify and document O&M requirements and confirm acceptability to the responsible party. See Chapters 7 and Chapter 8.

5.2 DMAs Excluded from DCV Calculation

This Manual provides project applicants the option to exclude DMAs from DCV calculations if they meet the criteria in this section. These DMAs must implement source control and site design BMPs from Chapter 4 as applicable and feasible. These exclusions are evaluated on a case-by-case basis, and approvals of these exclusions are at the discretion of P&EAD.

5.2.1 Self-mitigating DMAs

Self-mitigating DMAs consist of natural or landscaped areas that drain directly offsite or to the public storm drain system. Self-mitigating DMAs must meet **ALL** the following characteristics to be eligible for exclusion:

- Vegetation in the natural or landscaped area is native and/or non-native/non-invasive drought-tolerant species that do not require regular application of fertilizers and pesticides.
- Soils are undisturbed native topsoil or disturbed soils that have been amended and aerated to promote water retention characteristics equivalent to undisturbed native topsoil.
- The incidental impervious areas are less than 5 percent of the self-mitigating area.
- The impervious area within the self-mitigated area should not be hydraulically connected to other impervious areas unless it is a storm water conveyance system (such as brow ditches).
- The self-mitigating area is hydraulically separate from DMAs that contain permanent storm water pollutant control BMPs.

Figure 5-3 illustrates the concept of self-mitigating DMAs.

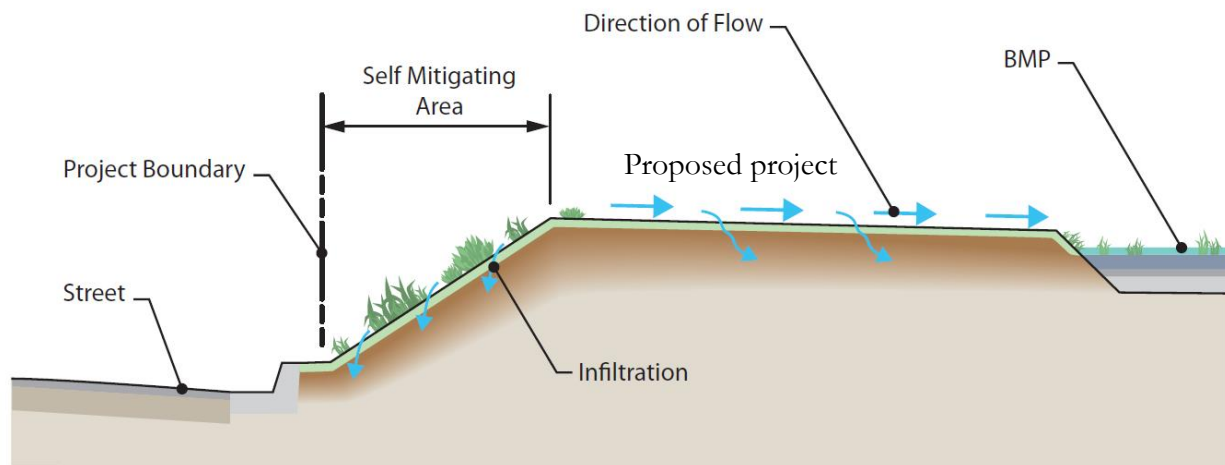

FIGURE 5-3. Self Mitigating Area

5.2.2 De Minimis DMAs

De minimis DMAs consist of areas that are very small and therefore are not considered to be significant contributors of pollutants; it is considered by the project proponent and P&EAD not to be practicable to drain to a BMP. It is anticipated that only a small subset of projects will qualify for de minimis DMA exclusion. Examples include driveway aprons connecting to existing streets, portions of sidewalks, retaining walls at the external boundaries of a project, and similar features. De minimis DMAs must include **ALL** the following characteristics to be eligible for exclusion:

- Areas abut the perimeter of the development site.
- Topography constraints make BMP construction to reasonably capture runoff technically infeasible.
- The portion of the site falling into this category is minimized through effective site design.
- Each DMA should have an area less than 250 square feet, and the sum of all de minimis DMAs should represent less than 2 percent of the total added or replaced impervious surface of the project. Except for projects for which 2 percent of the total added or replaced impervious surface of the project is less than 250 square feet, a de minimis DMA of 250 square feet or less is allowed.
- Two *de minimis* DMAs cannot be adjacent to each other and hydraulically connected.
- The SWQMP must document the reason that each de minimis area could not be addressed otherwise.

5.2.3 Self-retaining DMAs via Qualifying Site Design BMPs

Self-retaining DMAs are areas that are designed with site design BMPs to retain runoff to a level equivalent to pervious land. BMP fact sheets for Impervious Area Dispersion (SD-B in Appendix E) and Permeable Pavement (SD-D in Appendix E) describe the design criteria by which BMPs can be

Chapter 5: Storm Water Pollutant Control Requirements for PDPs

considered self-retaining. DMAs that are categorized as self-retaining DMAs are considered to meet **only** the storm water pollutant control obligations.

Requirements for using this category of DMA are as follows:

- Site design BMPs such as impervious area dispersion and permeable pavement may be used individually or in combination to reduce or eliminate runoff from a portion of a PDP.
- If a site design BMP is used to create a self-retaining DMA, then the site design BMP must be designed and implemented per the criteria in the applicable fact sheet. These criteria are conservatively developed to anticipate potential changes in DMA characteristics with time. The fact sheet criteria for impervious area dispersion and permeable pavement for meeting pollutant control requirement developed using continuous simulation are summarized as follows:
 - SD-B Impervious Area Dispersion: a DMA is considered self-retaining if the impervious to pervious ratio is:
 - 2:1 when the pervious area is composed of Hydrologic Soil Group A
 - 1:1 when the pervious area is composed of Hydrologic Soil Group B
 - SD-D Self-Retaining Permeable Pavement: a DMA is considered self-retaining if the ratio of total drainage area (including permeable pavement) to area of permeable pavement is 1.5:1 or less.

Note: The left side of ratios presented above represents the portion of the site that receives volume reduction, and the right side of the ratio represents the site design BMP that promotes the achieved volume reduction.
- Site design BMPs used as part of a self-retaining DMA or as part of reducing runoff coefficients from a DMA must be called out clearly on project plans and in the SWQMP.
- P&EAD may accept or reject a proposed self-retaining DMA meeting these criteria at its discretion. Examples of rationale for rejection may include the potential for negative impacts (such as infiltration or vector issues), potential for significant future alteration of this feature, inability to visually inspect and confirm the feature, etc.

Other site design BMPs can be considered self-retaining for meeting storm water pollutant control obligations if the long-term annual runoff volume (estimated using continuous simulation following guidelines in Appendix G) from the DMA is reduced to a level equivalent to pervious land, and the applicant provides supporting analysis and rationale for the reduction in long term runoff volume. Approval of other self-retaining areas is at the discretion of P&EAD. Figure 5-4 illustrates the concept of self-retaining DMAs.

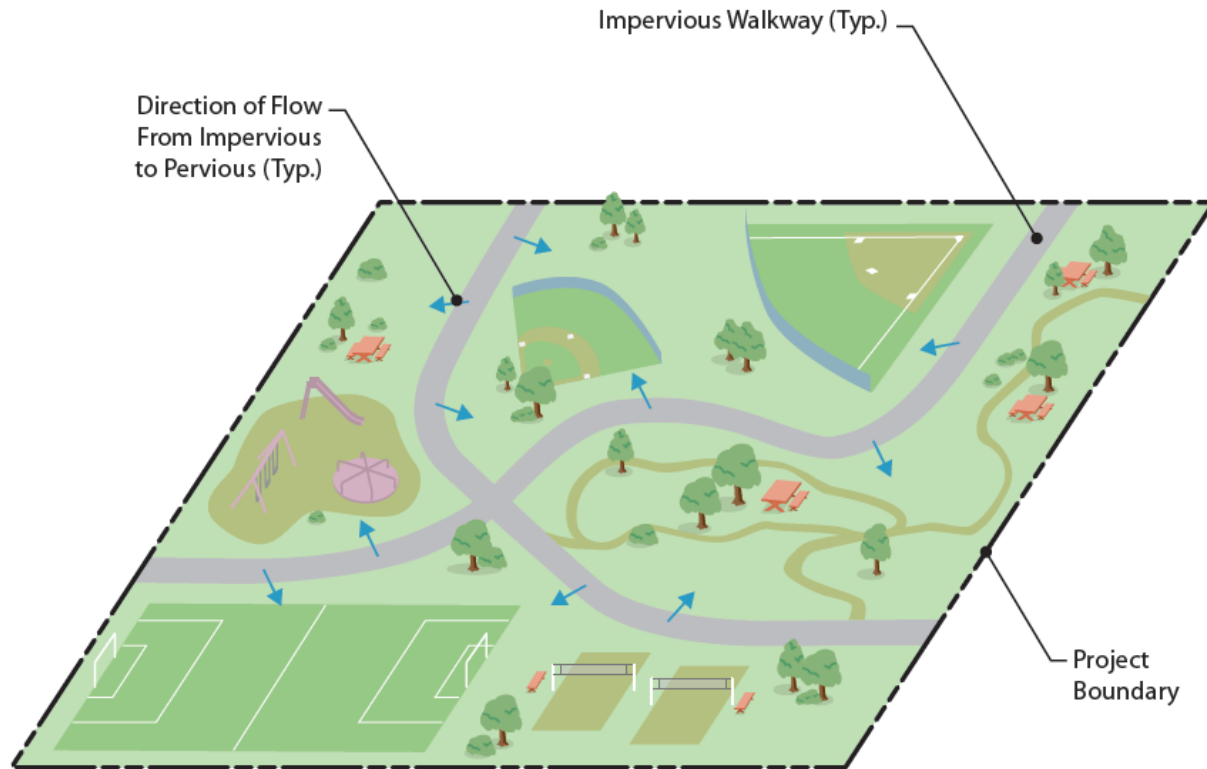

FIGURE 5-4. Self-retaining DMA Site

5.3 DCV Reduction Through Site Design BMPs

The site design BMPs discussed in Chapter 4 reduce the rate and volume of storm water runoff from the project site. This Manual provides adjustments to runoff factors for the following site design BMPs that may be incorporated into the project as part of an effective site design so that the downstream structural BMPs can be sized appropriately:

- SD-A Tree Wells
- SD-B Impervious Area Dispersion
- SD-C Green Roofs
- SD-D Permeable Pavement
- SD-E Rain Barrels
- SD-F Amended Soils

Methods for adjusting runoff factors for the site design BMPs listed above are presented in Appendix B.2. Site design BMPs used for reducing runoff coefficients from a DMA must be called out clearly on project plans and in the SWQMP. Approval of the claimed reduction of runoff factors is at the discretion of P&EAD.

5.4 Evaluating Feasibility of Storm Water Pollutant Control BMP Options

This section provides the fundamental process to establish that category, or combination of categories, of pollutant control BMP that is feasible and the volume of onsite retention that is feasible, either through harvest and use or infiltration of the DCV. The feasibility screening process presented in this section establishes the volume of retention that can be achieved to fully or partially meet the pollutant control performance standards.

5.4.1 Feasibility Screening for Harvest and Use Category BMPs

Harvest and use is a BMP that captures and stores storm water runoff for later use. The primary question to be evaluated is as follows:

- Is there a demand for harvested water within the project or project vicinity that can be met or partially met with rainwater harvesting in a practicable manner?

Appendix B.3 provides guidance for determining the feasibility of using harvested storm water based on onsite demand. Step 2 from Section 5.1 describes how the feasibility results need to be considered in the pollutant control BMP selection process.

5.4.2 Feasibility Screening for Infiltration Category BMPs

After accounting for any potential onsite use of storm water, the next step is to evaluate how much storm water can be retained onsite primarily through infiltration of the DCV. Infiltration of storm water is dependent on many important factors that must be evaluated as part of infiltration feasibility screening. The key questions for determining the degree of infiltration that can be accomplished onsite are as follows:

- Is infiltration potentially feasible and desirable?
- If so, what quantity of infiltration is potentially feasible and desirable?

These questions must be addressed in a systematic fashion to determine whether full infiltration of the DCV is potentially feasible. If, when answering these questions, it is determined that full infiltration is not feasible, then the portion of the DCV that could be infiltrated must be quantified, or a determination that infiltration in any appreciable quantity is infeasible or must be avoided. **This process is illustrated in Figure 5-5.** As a result of this process, conditions can be characterized as one of the following three categories:

- **Full Infiltration Condition:** Infiltration of the full DCV is potentially feasible and desirable. More rigorous design-level analyses should be used to confirm this classification and establish specific design parameters such as infiltration rate and factor of safety. BMPs in this category may include bioretention and infiltration basins. See Section 5.5.1.2.
- **Partial Infiltration Condition:** Infiltration of a significant portion of the DCV may be possible, but site factors may indicate that infiltration of the full DCV is either infeasible or not desirable. Select BMPs that provide opportunity for partial infiltration, e.g., biofiltration with partial retention. See Section 5.5.2.

Chapter 5: Storm Water Pollutant Control Requirements for PDPs

- **No Infiltration Condition:** Infiltration of any appreciable volume should be avoided. Some incidental volume losses may still be possible, but any appreciable quantity of infiltration would introduce undesirable conditions. Other pollutant control BMPs should be considered e.g., biofiltration or flow-through treatment control BMPs and participation in alternative compliance (Section 1.8) for the portion of the DCV that is not retained or biofiltered onsite. See Sections 5.5.3 and 5.5.4.

All PDPs are required to document the findings of the infiltration feasibility assessment, which must be supported by all associated information used in the feasibility findings. Appendices C and D provide additional guidance and criteria for performing and documenting the feasibility analysis for infiltration. At the site planning phase, preliminary screening can help guide the design process by influencing project layout and selection of infiltration BMPs and identifying the need for more detailed studies. At the design and final report submittal phase, planning-level categorizations related to infiltration must be confirmed or revised and rigorously documented and supported based on design-level investigations and analyses, as needed. A Geological Investigation Report typically must be prepared for PDPs implementing onsite structural BMPs. This report should be attached to the SWQMP. Geotechnical and groundwater investigation report requirements are listed in Appendix C.

Chapter 5: Storm Water Pollutant Control Requirements for PDPs

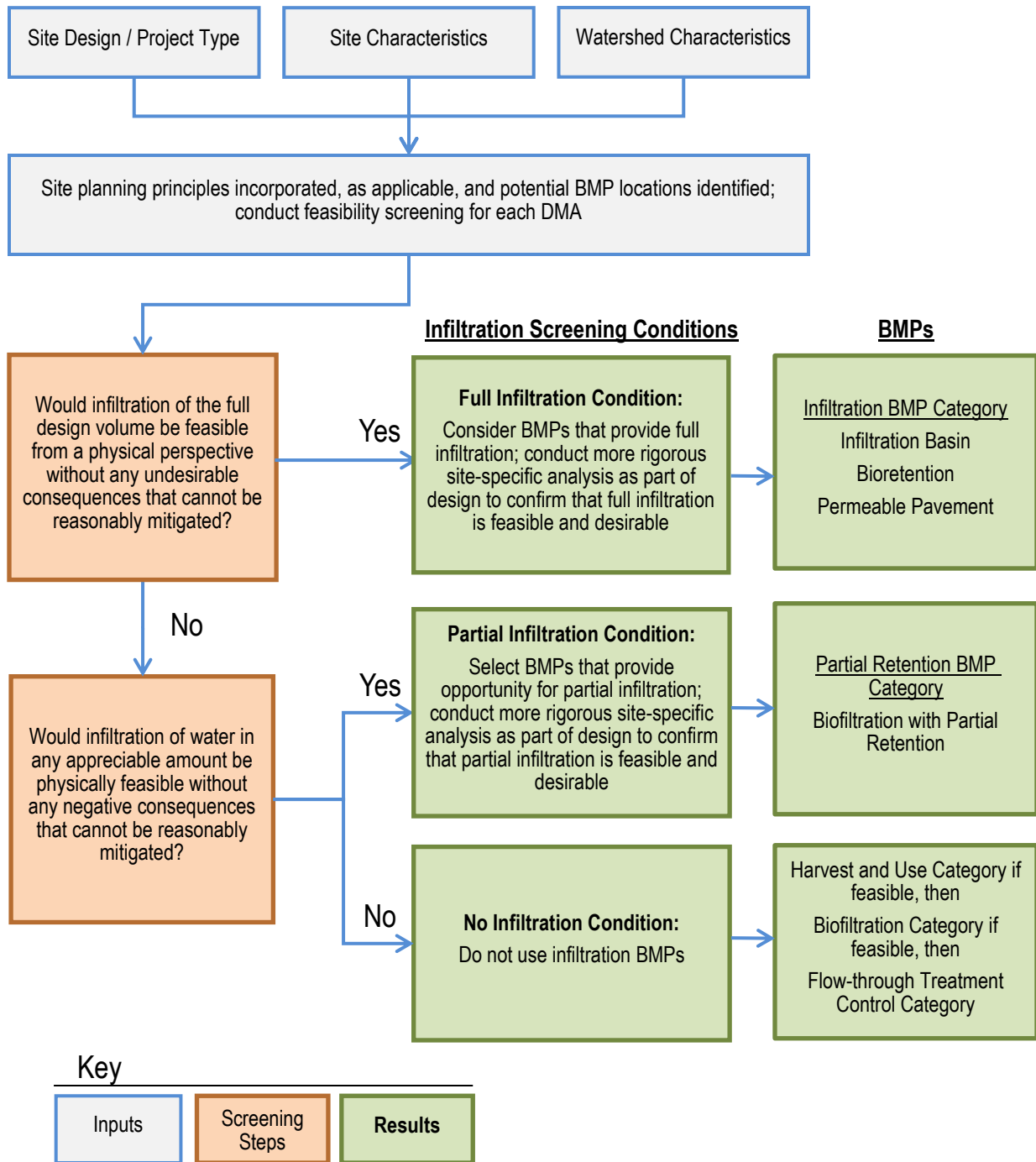

FIGURE 5-5. Infiltration Feasibility and Desirability Screening Flow Chart

5.5 BMP Selection and Design

BMP selection shall be based on steps listed in Section 5.1 and the feasibility screening process described in Section 5.4. Design of selected BMPs must be based on accepted design standards. The BMP designs described in the BMP fact sheets (Appendix E) shall constitute the allowable storm water pollutant control BMPs for the purpose of meeting storm water management requirements. Other BMP types and variations on these designs may be approved at the discretion of P&EAD if documentation demonstrates that the BMP is functionally equivalent to or better than those described in this Manual.

This section introduces each category of BMP and provides links to fact sheets that contain recommended criteria for the design and implementation of BMPs. Table 5-1 maps the BMP category to the fact sheets provided in Appendix E. Criteria specifically described in these fact sheets override guidance in outside-referenced source documents. Where criteria are not specified, the applicant and the project review staff should use best professional judgment based on the recommendations of the referenced guidance material or other published and generally accepted sources. When an outside source is used, the preparer must document the source in the SWQMP.

TABLE 5-1. Permanent Structural BMPs for PDPs

MS4 Permit Category	Manual Category	BMPs
Retention	Harvest and Use (HU)	HU-1: Cistern
Retention	Infiltration (INF)	INF-1: Infiltration basin INF-2: Bioretention INF-3: Permeable pavement
NA	Partial Retention (PR)	PR-1: Biofiltration with partial retention
Biofiltration	Biofiltration (BF)	BF-1: Biofiltration BF-2: Nutrient sensitive media design BF-3: Proprietary biofiltration
Flow-through treatment control	Flow-through (FT) Treatment Control with Alternative Compliance	FT-1: Vegetated swales FT-2: Media filters FT-3: Sand filters FT-4: Dry extended detention basins FT-5: Proprietary flow-through treatment control

5.5.1 Retention Category

5.5.1.1 Harvest and Use BMP Category

Harvest and use (typically referred to as rainwater harvesting) BMPs capture and store storm water runoff for later use. These BMPs are engineered to store a specified volume of water, and they have no design surface discharge until this volume is exceeded. Uses of captured water shall not result in runoff to storm drains or receiving waters. Potential uses of captured water may include irrigation demand, indoor non-potable demand, industrial process water demand, or other demands.

Selection: Harvest and use BMPs shall be selected after performing a feasibility analysis per Section 5.4.1. Based on findings from Section 5.4, if both harvest and use and full infiltration of the DCV are feasible onsite, the project applicant has an option to implement harvest and use BMPs and/or infiltration BMPs to meet the storm water requirements.

Design: A worksheet for sizing harvest and use BMPs is presented in Appendix B.3, and the fact sheet for sizing and designing the harvest and use BMP is presented in Appendix E. Figure 5-6 shows a schematic of a harvest and use BMP.

BMP option under this category:

- HU-1: Cistern

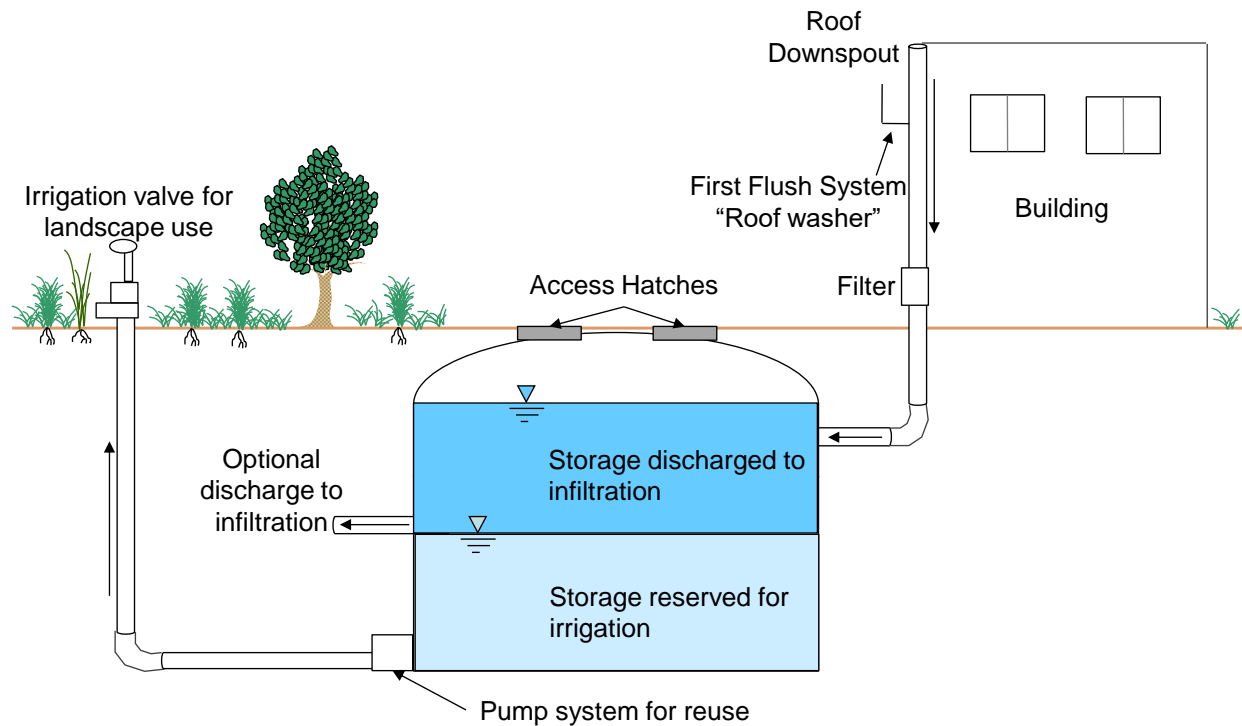

FIGURE 5-6. Schematic of a Typical Cistern

5.5.1.2 Infiltration BMP Category

Infiltration BMPs are structural measures that capture, store, and infiltrate storm water runoff. These BMPs are engineered to store a specified volume of water, and they have no design surface discharge (underdrain or outlet structure) until this volume is exceeded. These types of BMPs may also support evapotranspiration processes but are characterized by having their most dominant volume losses due to infiltration. Pollution prevention and source control BMPs shall be implemented at a level appropriate to protect groundwater quality for areas draining to infiltration BMPs, and runoff must undergo pretreatment such as sedimentation or filtration prior to infiltration.

Selection: Selection of this BMP category shall be based on analysis in accordance with Sections 5.1 and 5.4.2. Dry wells are considered Class V injection wells and are subject to underground injection control (UIC) regulations. Dry wells are allowed only when registered with USEPA.

Design: Appendix B.4 has a worksheet for sizing infiltration BMPs, Appendix D has guidance for estimating infiltration rates for use in design the BMP, and Appendix E provides fact sheets to design the infiltration BMPs. Appendices B.6.2.1, B.6.2.2, and D.5.3 provide guidance for selecting appropriate pretreatment for infiltration BMPs. Figure 5-7 shows a schematic of an infiltration basin.

BMP options under this category:

- INF-1: Infiltration Basins
- INF-2: Bioretention
- INF-3: Permeable Pavement

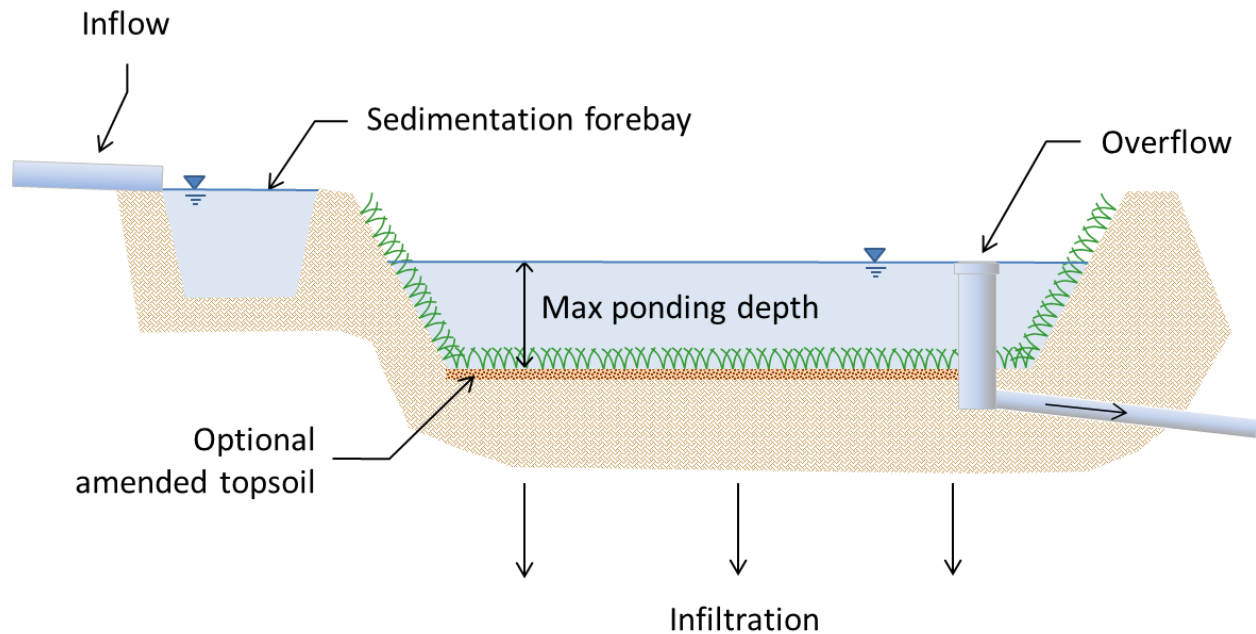

FIGURE 5-7. Schematic of a Typical Infiltration Basin

5.5.2 Partial Retention BMP Category

The partial retention category is defined by structural measures that incorporate both infiltration (in the lower treatment zone) and biofiltration (in the upper treatment zone). An example is a biofiltration with partial retention BMP.

5.5.2.1 Biofiltration With Partial Retention BMP

Biofiltration with partial retention BMPs are shallow basins filled with treatment media and drainage rock that manage storm water runoff through infiltration, evapotranspiration, and biofiltration. These BMPs are characterized by a subsurface stone infiltration storage zone in the bottom of the BMP below the elevation of the discharge from the underdrains. The discharge of biofiltered water from the underdrain occurs when the water level in the infiltration storage zone exceeds the elevation of the underdrain outlet. The storage volume can be controlled by the elevation of the underdrain outlet (shown in Figure 5-8) or other configurations. Other typical biofiltration with partial retention components include a media layer and associated filtration rates, drainage layer with associated in situ soil infiltration rates, and vegetation.

Selection: A biofiltration with partial retention BMP shall be selected if the project site feasibility analysis performed in accordance with Section 5.4.2 determines a partial infiltration feasibility condition.

Design: Appendix B.5 provides guidance for sizing biofiltration with partial retention BMP, and Appendix E provides a fact sheet to design a biofiltration with partial retention BMP.

BMP option under this category:

- PR-1: Biofiltration with Partial Retention

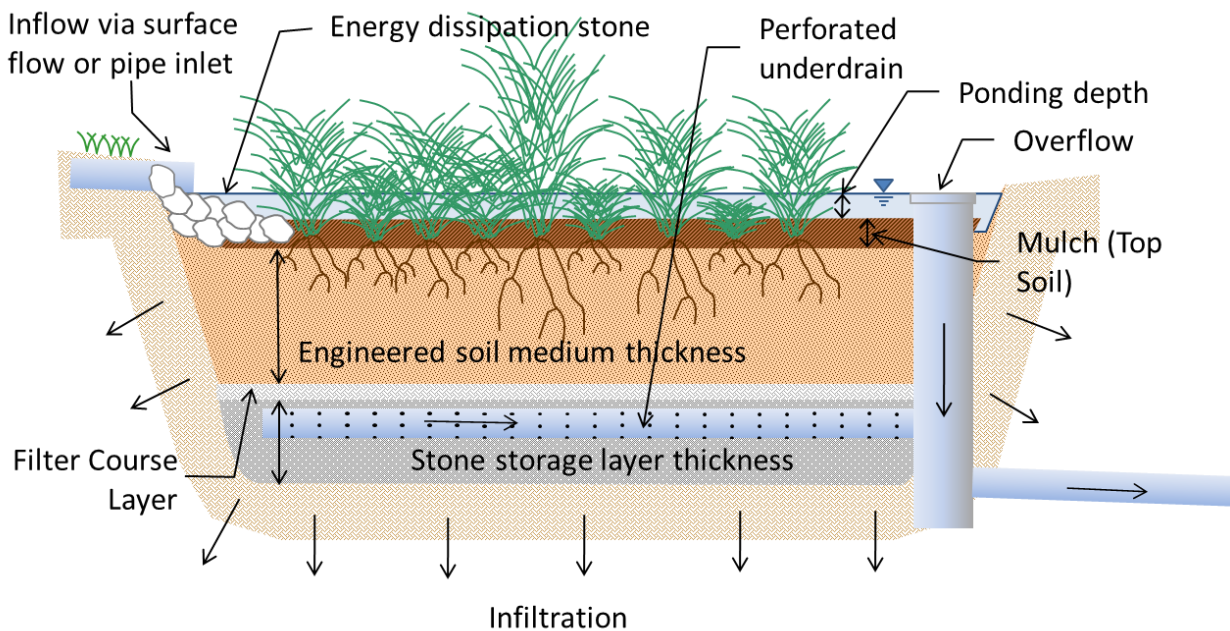

FIGURE 5-8. Schematic of a Typical Biofiltration with Partial Retention BMP

5.5.3 Biofiltration BMP Category

Biofiltration BMPs are shallow basins filled with treatment media and drainage rock that treat storm water runoff by capturing and detaining inflows prior to controlled release through minimal incidental infiltration, evapotranspiration, or discharge via an underdrain or surface outlet structure. Treatment is achieved through filtration, sedimentation, sorption, biochemical processes, and/or vegetative uptake. Biofiltration BMPs can be designed with or without vegetation, provided that biological treatment processes are present throughout the life of the BMP via maintenance of plants, media base flow, or other biota-supporting elements. By default, BMP BF-1 (Biofiltration) shall include vegetation unless it is demonstrated, to the satisfaction of P&EAD, that effective biological treatment process will be maintained without vegetation. Typical biofiltration components include a media layer with associated filtration rates, drainage layer with associated in-situ soil infiltration rates, underdrain, inflow and outflow control structures, and vegetation, with an optional impermeable liner installed on an as needed basis due to site constraints.

Selection: Biofiltration BMPs shall be selected if the project site feasibility analysis performed in accordance with Section 5.4.2 determines a no infiltration feasibility condition.

Design: Appendix B.5 has a worksheet for sizing biofiltration BMPs, and Appendix E provides fact sheets to design the biofiltration BMP. Figure 5-9 shows the schematic of a biofiltration basin.

BMP options under this category:

- BF-1: Biofiltration
- BF-2: Nutrient Sensitive Media Design
- BF-3: Proprietary Biofiltration

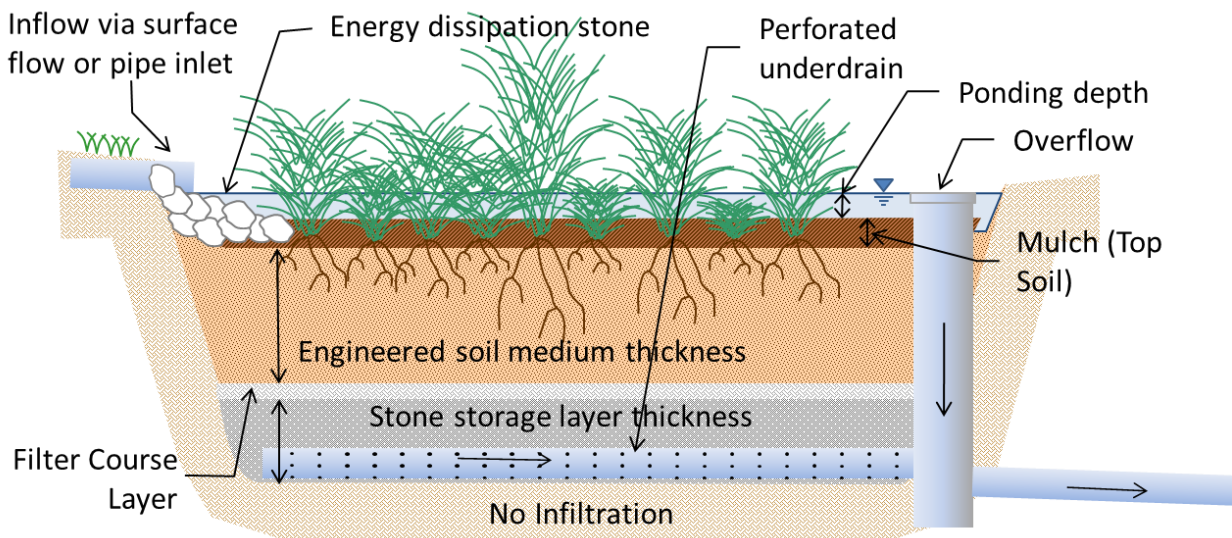

FIGURE 5-9. Schematic of a Typical Biofiltration Basin

Alternative Biofiltration Options: Other BMPs, including proprietary BMPs (see fact sheet for BF-3 Proprietary Biofiltration) may be classified as biofiltration BMPs if they (1) meet the minimum design criteria listed in Appendix F, including the pollutant treatment performance standard in Appendix F.1, (2) are designed and maintained in a manner consistent with performance certifications, if applicable, and (3) are acceptable at the discretion of P&EAD. The applicant may be required to provide additional studies and/or required to meet additional design criteria beyond the scope of this document to demonstrate that these criteria are met. In determining the acceptability of an alternative biofiltration BMP, the Authority considers, as applicable, (1) the data submitted; (2) the representativeness of the data submitted; (3) the consistency of the BMP performance claims with pollutant control objectives; certainty of the BMP performance claims; (4) for projects within the public right of way and/or public projects, the maintenance requirements, cost of maintenance activities, relevant previous local experience with operation and maintenance of the BMP type, and ability to continue to operate the system in event that the vending company is no longer operating as a business; and (5) other relevant factors. If a proposed BMP is not accepted by P&EAD, a written explanation/reason is provided to the applicant.

5.5.4 Flow-through Treatment Control BMPs (for Use with Alternative Compliance) Category

Flow-through treatment control BMPs are structural, engineered facilities that are designed to remove pollutants from storm water runoff that do not meet the MS4 Permit criteria for biofiltration.

Selection: Flow-through treatment control BMPs shall be selected using the criteria in Appendix B.6. Flow-through treatment control BMPs may be implemented to satisfy PDP structural BMP performance requirements only if an appropriate offsite ACP is also constructed to mitigate the pollutant load in the portion of the DCV not retained onsite. The ACP is an optional element that may be developed by each jurisdiction (see Section 1.8).

Design: Appendix B.6 provides the methodology, required tables, and worksheet for sizing flow-through treatment control BMPs, and Appendix E provides fact sheets to design the following flow-through treatment control BMPs. Figure 5-10 shows a schematic of a vegetated swale as an example of a flow-through treatment control BMP.

BMP options under this category:

- FT-1: Vegetated Swales
- FT-2: Media Filters
- FT-3: Sand Filters
- FT-4: Dry Extended Detention Basin
- FT-5: Proprietary Flow-Through Treatment Control

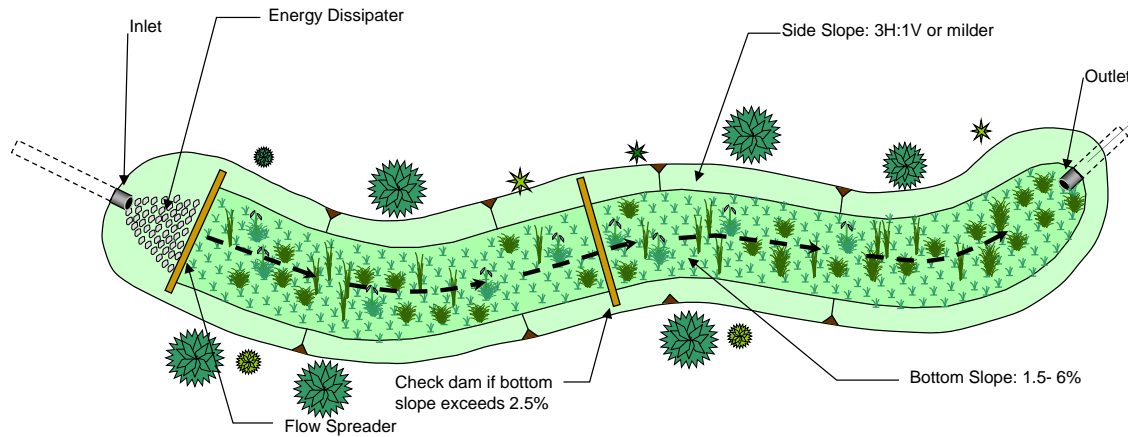

FIGURE 5-10. Schematic of a Vegetated Swale

Use of Proprietary BMP Options: A proprietary BMP (see fact sheet FT-5) can be classified as a flow-through treatment control BMP if it is (1) demonstrated to meet the flow-through treatment performance criteria in Appendix B.6, (2) designed and maintained in a manner consistent with its applicable performance certifications, and (3) acceptable at the discretion of the P&EAD. The applicant may be required to provide additional studies and/or required to meet additional design criteria beyond the scope of this document to justify the use of a proprietary flow-through treatment control BMP. In determining the acceptability of an proprietary flow-through treatment control BMP, the Authority considers, as applicable, (1) the data submitted; (2) the representativeness of the data submitted; (3) the consistency of the BMP performance claims with pollutant control objectives; certainty of the BMP performance claims; (4) for projects within the public right of way and/or public projects, the maintenance requirements, cost of maintenance activities, relevant previous local experience with operation and maintenance of the BMP type, and ability to and continue to operate the system in event that the vending company is no longer operating as a business; and (5) other relevant factors. If a proposed BMP is not accepted by P&EAD, a written explanation/reason is provided to the applicant.

5.5.5 Alternative BMPs

New and proprietary BMP technologies may be available that meet the performance standards in Chapter 2 but are not discussed in this Manual. Use of these alternative BMPs to comply with MS4 Permit obligations is at the discretion of the P&EAD. In determining the acceptability of an alternative BMP, P&EAD should consider, as applicable, (1) the data submitted; (2) the representativeness of the data submitted; (3) the consistency of the BMP performance claims with pollutant control objectives and certainty of the BMP performance claims; (4) for projects within the public right of way and/or public projects: maintenance requirements, the cost of maintenance activities, relevant previous local experience with operation and maintenance of the BMP type, and ability to continue to operate the system in the event that the vending company is no longer operating as a business; and (5) other relevant factors. If a proposed BMP is not accepted by the Authority, a written explanation/reason is provided to the applicant. Alternative BMPs must meet the standards for biofiltration BMPs or flow-through BMPs (depending on how they are used), as described in Appendices F and B.6, respectively.

Hydromodification Management Requirements for PDPs

The purpose of hydromodification management requirements for PDPs is to minimize the potential of storm water discharges from the MS4 from causing altered flow regimes and excessive downstream erosion in receiving waters. As discussed in Section 1.6, development within Authority jurisdiction is not subject to hydromodification management requirements. All discharges drain directly to San Diego Bay, an enclosed embayment. Therefore, this section, as written in the Model BMP Design Manual, is not included.

This page intentionally left blank

Long Term Operation and Maintenance

Permanent structural BMPs require ongoing inspection and maintenance into perpetuity to preserve the intended pollution control and/or flow control performance.

This chapter addresses procedural requirements for implementation of long-term O&M and the typical maintenance requirements of structural BMPs presented in the Manual. Specific requirements for O&M Plan reports are discussed in Chapter 8 with the Submittal Requirements.

7.1 Need for Permanent Inspection and Maintenance

7.1.1 MS4 Permit Requirements

The MS4 Permit requires that the Authority implement a program that requires and confirms that structural BMPs on all PDPs are designed, constructed, and maintained to remove pollutants in storm water to the MEP.

Routine inspection and maintenance of BMPs preserve the design and MS4 Permit objective to remove pollutants in storm water to the MEP. The MS4 Permit requirement specifically applies to PDP structural BMPs. However, source control BMPs and site design/LID BMPs within a PDP are components in the storm water management scheme that determine the amount of runoff to be treated by structural BMPs; when source control, site design, or LID BMPs are not maintained, clogging or failure of structural BMPs can result because of greater delivery of runoff and pollutants than intended. Therefore, P&EAD may also require confirmation of maintenance of source control BMPs and site design/LID BMPs as part of their PDP structural BMP maintenance documentation requirements (see Section 7.4).

7.1.2 Practical Considerations

Why do permanent structural BMPs require ongoing inspection and maintenance into perpetuity?

By design, structural BMPs trap pollutants transported by storm water. Structural BMPs are subject to deposition of solids such as sediment, trash, and other debris. Some structural BMPs are also subject to growth of vegetation, either by design (e.g., biofiltration) or incidentally. The pollutants and any overgrown vegetation must be removed on a periodic basis for the life of the BMP to maintain the

capacity of the structural BMP to process storm water and capture pollutants from every storm event. Structural BMP components are also subject to clogging from trapped pollutants and growth of vegetation. Clogged BMPs can result in flooding, standing water, and mosquito breeding habitat. Maintenance is critical to ensure the ongoing drainage of the facility. All components of the BMP must be maintained, including both the surface and any subsurface components.

Vegetated structural BMPs, including vegetated infiltration or partial infiltration BMPs and aboveground detention basins, also require routine maintenance so that they do not inadvertently become wetlands, waters of the state, or sensitive species habitat under the jurisdiction of the United States Army Corps of Engineers, SDRWQCB, California Department of Fish and Wildlife, or United States Fish and Wildlife Service. A structural BMP that is constructed in the vicinity of, or connected to, an existing jurisdictional water or wetland could inadvertently result in creation of expanded waters or wetlands. As such, vegetated structural BMPs have the potential to come under the jurisdiction of one or more of the above-mentioned resource agencies. This could result in the need for specific resource agency permits and costly mitigation to maintain the structural BMP. Along with proper placement of a structural BMP, routine maintenance is key to preventing this scenario.

7.2 Summary of Steps to Maintenance Agreement

Ownership and maintenance responsibility for structural BMPs should be discussed at the beginning of project planning, typically at the pre-application meeting with P&EAD.

Experience has shown provisions to finance and implement maintenance of BMPs can be a major stumbling block to project approval. Project owners shall be aware of their responsibilities regarding storm water BMP maintenance and need to be familiar with the contents of the O&M Plan prepared for the project. Chapter 8 provides the guidelines for preparation of a site-specific O&M Plan. A maintenance mechanism must be determined prior to the issuance of any construction, grading, building, site development permit, or any other applicable permit. Table 7-1 lists the typical steps and schedule for establishing a plan and mechanism to ensure ongoing maintenance of structural BMPs.

TABLE 7-1. Schedule for Developing O&M Plan and Agreement

Item	Description	Time Frame
1	Determine structural BMP ownership, party responsible for permanent O&M, and maintenance funding mechanism	Prior to first submittal of a project application – discuss with staff at pre-application meeting
2	Identify expected maintenance actions	First submittal of a project application – identify in SWQMP
3	Develop a detailed O&M Plan	As required by P&EAD, prior to issuance of project approvals
4	Update/finalize the O&M Plan to reflect constructed structural BMPs with as-built plans and baseline photos	As required by P&EAD, upon completion of construction of structural BMPs
5	Prepare a draft O&M Agreement	As required by P&EAD and Business and Financial Management Department
6	Execute the O&M Agreement	As required by P&EAD and Business and Financial Management Department

The final O&M Plan submitted to P&EAD must describe the designated responsible party to manage the structural BMP(s), any necessary employee or tenant training and duties, operating schedule, maintenance frequency, specific maintenance activities, copies of resource agency permits, and any other necessary activities. At a minimum, the O&M Plan requires inspection and servicing of all structural BMPs on an annual basis. The tenant shall document all maintenance and shall retain records for at least 5 years. These documents shall be made available to the Authority for inspection upon request at any time. O&M Plans are also prepared for capital projects that include structural BMPs.

The Authority maintains the right to access tenant properties as part of lease provisions. This right extends to any access required related to structural BMPs.

7.3 Maintenance Responsibility

Who is responsible for the maintenance of the permanent structural BMPs into perpetuity?

The project owner is responsible to ensure inspection and O&M of permanent structural BMPs within the facility (i.e., either the Authority itself or a tenant, unless responsibility has been formally transferred from the tenant to the Authority). For tenant projects, when tenant areas change (i.e., the area falls under a new tenant lease), maintenance responsibility also transfers to the new tenant. For Authority projects, FMD is responsible for maintenance. If property ownership changes (i.e., the property is sold or otherwise transferred to a new owner), maintenance responsibility also transfers to the new owner. For tenant structural BMPs that will be transferred to the Authority, there may be an interim period during which the tenant is responsible until maintenance responsibility is formally transferred.

From the time that the structural BMP is constructed and activated (i.e., it is operating and processing storm water from storm events), it requires inspection and maintenance to ensure that it continues to function as designed. As a result, the MS4 Permit requires that each jurisdiction "require the project applicant to submit proof of the mechanism under which ongoing long-term maintenance of all structural BMPs will be conducted." The various jurisdictions have different allowable maintenance mechanisms (e.g., privately funded or publicly funded maintenance) and/or requirements for proof of the maintenance mechanism (e.g., maintenance agreements). Requirements for proof of the maintenance mechanism may also differ depending on whether the long-term O&M will be provided by a public or private party.

For projects within the Authority jurisdiction, structural BMP maintenance is provided by the Authority for capital projects (i.e., public entity maintenance) and is provided by the individual tenants for tenant projects (i.e., through lease provisions). As part of the project review for both capital and tenant PDPs that include structural BMPs, the Authority verifies that appropriate mechanisms are in place. The maintenance mechanisms include the following:

- 1) Public entity maintenance: The Authority provides storm water BMP maintenance for its capital projects. Funding is provided on an ongoing basis through inclusion of maintenance costs in annual operating budgets for any department with BMP maintenance responsibility.
- 2) Lease provisions: The Authority ensures storm water BMP maintenance, repair, and replacement of tenant projects through conditions in tenant leases. An example Tenant Condition of Approval is included in Appendix A.4.

- 3) Other mechanisms: On a case-by-case basis, the Authority may consider other mechanisms for structural BMP maintenance such as inclusion of maintenance conditions in a use permit, or alternative mechanisms, subject to P&EAD approval.

7.4 Long-Term Maintenance Documentation

As part of ongoing structural BMP maintenance into perpetuity, property owners are required to provide documentation of maintenance for the structural BMPs on their property to support the Authority's reporting requirements to the SDRWQCB.

The MS4 Permit requires the Authority to verify that structural BMPs on each PDP "are adequately maintained and continue to operate effectively to remove pollutants in storm water to the MEP through inspections, self-certifications, surveys, or other equally effective approaches." The Authority must also identify the party responsible for structural BMP maintenance for the PDP and report the dates and findings of structural BMP maintenance verifications, and corrective actions and/or resolutions when applicable, in their PDP inventory. The PDP inventory and findings of maintenance verifications must be reported to the SDRWQCB annually.

P&EAD annually inspects (unless more frequent inspections are required) the Authority-owned PDP structural BMPs for the need for cleanout or maintenance and advises FMD of the need for such work. FMD then determines the appropriate maintenance required to continue to operate the BMPs in accordance with the manufacturer's recommendations, and to ensure effective operation of the BMP in removing pollutants in storm water to the MEP. FMD records the maintenance of these BMPs. Before October 1 of each year, P&EAD inspects the FMD documentation of maintenance.

Structural BMPs constructed by tenants are generally maintained by tenants unless the Authority and FMD have assumed responsibility under the terms of the tenant's lease or some other mechanism. Structural BMPs constructed by tenants are either inspected by P&EAD annually before October 1, or the tenant is allowed to self-certify inspection and maintenance. Structural BMPs associated with PDPs designated high priority by the Authority are not eligible for self-certification and are inspected by P&EAD directly. Tenants who have been authorized by P&EAD to perform their own inspections and maintenance of structural BMPs are required to submit documentation and self-certification that inspection and maintenance were performed prior to October 1.

7.5 Inspection and Maintenance Frequency

How often is a project owner required to inspect and maintain permanent structural BMPs on their facility?

The minimum inspection, maintenance, and reporting frequency is annually. However, actual maintenance needs are site specific, and maintenance may be needed more frequently than annually. The need for maintenance depends on the amount and quality of runoff delivered to the structural BMP. Maintenance must be performed whenever needed, based on maintenance indicators presented in Section 7.7. The optimum maintenance frequency is each time the maintenance threshold for removal of materials (sediment, trash, debris, or overgrown vegetation) is met. If this maintenance threshold has been exceeded by the time the structural BMP is inspected, the BMP has been operating at reduced capacity. This would mean it is necessary to inspect and maintain the structural BMP more

frequently. Routine maintenance also helps avoid more costly rehabilitative maintenance to repair damages that may occur when BMPs have not been adequately maintained on a routine basis.

During the first year of normal operation of a structural BMP (i.e., when the project is fully built out and occupied), inspection by P&EAD or the tenant is recommended at least once prior to August 31 and then monthly from September through May. Inspection during a storm event is also recommended. It is during and after a rain event that one can determine whether the components of the BMP are functioning properly. After the initial period of frequent inspections, the minimum inspection and maintenance frequency can be determined based on the results of the first-year inspections.

P&EAD may require an increased inspection frequency by FMD or the tenant in cases in which an annual inspection has proven insufficient based on documentation provided to P&EAD or independent inspections conducted by P&EAD.

7.6 Measures to Control Maintenance Costs

Because structural BMPs must be maintained into perpetuity, it is essential to include measures to control maintenance costs.

The most effective way to reduce maintenance of structural BMPs is to prevent or reduce pollutants generated onsite and delivered to the structural BMP by implementation of source control and site design BMPs onsite, as required and described in Chapter 4. Second, vegetated BMPs should be placed properly to reduce the potential to come under the jurisdiction of one or more resource agencies that could require permits and costly mitigation to maintain the structural BMP. Third, the structural BMP should include design features to facilitate maintenance, as follows.

Considerations for placement of vegetated BMPs:

- Locate structural BMPs outside floodway, floodplain, and other jurisdictional areas.
- Avoid direct connection to a natural surface water body.
- Discuss the location of the structural BMP with a wetland biologist to avoid placing a structural BMP in a location where it could become jurisdictional or be connected to a jurisdictional area.

Measures to facilitate collection of the trapped pollutants:

- Design a forebay to trap gross pollutants in a contained area that is readily accessible for maintenance. A forebay may be a dedicated area at the inlet entrance to an infiltration BMP, biofiltration BMP, or detention basin, or may be a gross pollutant separator installed in the storm drain system that drains to the primary structural BMP.

Measures to access the structural BMP:

- The BMP must be accessible to equipment needed for maintenance. Access requirements for maintenance vary with the type of facility selected.

Chapter 7: Long-Term Operation and Maintenance

- Infiltration BMPs, biofiltration BMPs, and most aboveground detention basins and sand filters typically require routine landscape maintenance using the same equipment that is used for general landscape maintenance. At times, these BMPs may require excavation of clogged media (e.g., bioretention soil media, or sand for the sand filter), and should be accessible to appropriate equipment for excavation and removal/replacement of media.
- Aboveground detention basins should include access ramps for trucks to enter the basin to bring equipment and to remove materials.
- Underground BMPs such as detention vaults, media filters, or gross pollutant separators used as forebays to other BMPs typically require access for a vactor truck to remove materials. Proprietary BMPs such as media filters or gross pollutant separators may require access by a forklift or other truck for delivery and removal of media cartridges or other internal components. Access requirements must be verified with the manufacturer of proprietary BMPs.
- Vactor trucks are large, heavy, and difficult to maneuver. Structural BMPs that are maintained by vactor truck must include a level pad adjacent to the structural BMP, preferably with no vegetation or irrigation system (otherwise vegetation or irrigation system may be destroyed by the vactor truck).
- The sump area of a structural BMP should not exceed 20 feet in depth because of the loss of efficiency of a vactor truck. The water removal rate is 3 to 4 times longer when the depth is greater than 20 feet. Deep structures may require additional equipment (stronger vactor trucks, ladders, more vactor pipe segments).
- All manhole access points to underground structural BMPs must include a ladder or steps.

Measures to facilitate inspection of the structural BMP

- Structural BMPs shall include inspection ports for observing all underground components that require inspection and maintenance.
- Silt level posts or other markings shall be included in all BMP components that trap and store sediment, trash, and/or debris, so that the inspector may determine how full the BMP is, and maintenance personnel may determine where the bottom of the BMP is. Posts or other markings shall be indicated and described on structural BMP plans.
- Vegetation requirements, including plant type, coverage, and minimum height when applicable, shall be provided on the structural BMP and/or landscaping plans as appropriate or as required by P&EAD.
- Signage indicating the location and boundary of the structural BMP is recommended.

When designing a structural BMP, the engineer should review the typical structural BMP maintenance actions listed in Section 7.7 to determine the potential maintenance equipment and access needs.

When selecting permanent structural BMPs for a project, the engineer and project owner should consider the long-term cost of maintenance and the type of maintenance contracts a future project owner will need to manage. The types of materials used (e.g., proprietary versus non-proprietary parts), equipment used (e.g., landscape equipment versus vactor truck), and actions/labor expected in the

maintenance process and required qualifications of maintenance personnel (e.g., confined space entry) affect the cost of long-term O&M of the structural BMPs presented in the Manual.

7.7 Maintenance Indicators and Actions for Structural BMPs

This section presents typical maintenance indicators and expected maintenance actions (routine and corrective) for typical structural BMPs.

There are many different variations of structural BMPs, and structural BMPs may include multiple components. For maintenance, the structural BMPs have been grouped into four categories based on common maintenance requirements:

- Vegetated infiltration or filtration BMPs
- Non-vegetated infiltration BMPs
- Non-vegetated filtration BMPs
- Detention BMPs

The project civil engineer is responsible for determining the categories that are applicable based on the components of the structural BMP, and for identifying the applicable maintenance indicators from within the category. Maintenance indicators and actions shall be shown on the construction plans and in the project-specific O&M Plan.

During inspection, the inspector checks the maintenance indicators. If one or more thresholds are met or exceeded, maintenance must be performed to ensure that the structural BMP will function as designed during the next storm event. Table 7-2 through Table 7-5 present general maintenance actions for the four BMP categories. Additional guidance is provided in the Appendix E fact sheets for each specific BMP.

7.7.1 Maintenance of Vegetated Infiltration or Filtration BMPs

"Vegetated infiltration or filtration BMPs" are BMPs that include vegetation as a component. Applicable fact sheets may include INF-2 (Bioretention), PR-1 (Biofiltration With Partial Retention), BF-1 (Biofiltration), or FT-1 (Vegetated Swale). The vegetated BMP may or may not include amended soils, subsurface gravel layer, underdrains, and/or impermeable liners. The project civil engineer is responsible for determining which maintenance indicators and actions listed in Table 7-2 are applicable based on the components of the structural BMP.

TABLE 7-2. Maintenance Indicators and Actions for Vegetated BMPs

Typical Maintenance Indicator(s) for Vegetated BMPs	Maintenance Actions
Accumulation of sediment, litter, or debris	Remove and properly dispose of accumulated materials, without damage to the vegetation.
Poor vegetation establishment	Re-seed, re-plant, or re-establish vegetation per original plans.
Overgrown vegetation	Mow or trim as appropriate, but to a height not less than the design height of the vegetation per original plans when applicable (e.g., a vegetated swale may require a minimum vegetation height).
Erosion due to concentrated irrigation flow	Repair/re-seed/re-plant eroded areas and adjust the irrigation system.
Erosion due to concentrated storm water runoff flow	Repair/re-seed/re-plant eroded areas and make appropriate corrective measures such as adding erosion control blankets, adding stone at flow entry points, or performing minor re-grading to restore proper drainage according to the original plan. If the issue is not corrected by restoring the BMP to the original plan and grade, the engineer shall be contacted prior to any additional repairs or reconstruction.
Standing water in vegetated swales	Make appropriate corrective measures such as adjusting the irrigation system, removing obstructions of debris or invasive vegetation, loosening, or replacing topsoil to allow for better infiltration, or performing minor re-grading for proper drainage. If the issue is not corrected by restoring the BMP to the original plan and grade, the engineer shall be contacted prior to any additional repairs or reconstruction.
Standing water in bioretention, biofiltration with partial retention, or biofiltration areas, or flow-through planter boxes for longer than 96 hours following a storm event*	Make appropriate corrective measures such as adjusting the irrigation system, removing obstructions of debris or invasive vegetation, clearing underdrains (where applicable), or repairing/replacing clogged or compacted soils.
Obstructed inlet or outlet structure	Clear obstructions.
Damage to structural components such as weirs, inlet, or outlet structures	Repair or replace as applicable.
*These BMPs typically include a surface ponding layer as part of their function which may take 96 hours to drain following a storm event.	

7.7.2 Maintenance of Non-Vegetated Infiltration BMPs

"Non-vegetated infiltration BMPs" are BMPs that store storm water runoff until it infiltrates into the ground, and do not include vegetation as a component of the BMP (refer to the "vegetated BMPs" category for infiltration BMPs that include vegetation). Non-vegetated infiltration BMPs generally include non-vegetated infiltration trenches and infiltration basins, dry wells, underground infiltration galleries, and permeable pavement with underground infiltration gallery. Applicable fact sheets may include INF-1 (Infiltration Basin) or INF-3 (Permeable Pavement). The non-vegetated infiltration BMP may or may not include a pre-treatment device and may or may not include aboveground storage

of runoff. The project civil engineer is responsible for determining which maintenance indicators and actions listed in Table 7-3 are applicable based on the components of the structural BMP.

TABLE 7-3. Maintenance Indicators and Actions for Non-Vegetated Infiltration BMPs

Typical Maintenance Indicator(s) for Non-Vegetated Infiltration BMPs	Maintenance Actions
Accumulation of sediment, litter, or debris in infiltration basin or pre-treatment device, or on permeable pavement surface	Remove and properly dispose of accumulated materials.
Standing water in infiltration basin without subsurface infiltration gallery for longer than 96 hours following a storm event	Remove and replace clogged surface soils.
Standing water in subsurface infiltration gallery for longer than 96 hours following a storm event	This condition requires investigation of why infiltration is not occurring. If feasible, take corrective action to restore infiltration (e.g., flush fine sediment or remove and replace clogged soils). The BMP may require retrofit if infiltration cannot be restored. If retrofit is necessary, the engineer shall be contacted prior to any repairs or reconstruction.
Standing water in permeable paving area	Flush fine sediment from paving and subsurface gravel. Provide routine vacuuming of permeable paving areas to prevent clogging.
Damage to permeable paving surface	Repair or replace damaged surface as appropriate.
Note: When inspection or maintenance indicates that sediment is accumulating in an infiltration BMP, the DMA draining to the infiltration BMP should be examined to determine the source of the sediment, and corrective measures should be made as applicable to minimize the sediment supply.	

7.7.3 Maintenance of Non-Vegetated Filtration BMPs

"Non-vegetated filtration BMPs" include Media Filters (FT-2) and Sand Filters (FT-3). These BMPs function by passing runoff through the media to remove pollutants. The project civil engineer is responsible for determining which maintenance indicators and actions listed in Table 7-4 are applicable based on the components of the structural BMP.

TABLE 7-4. Maintenance Indicators and Actions for Filtration BMPs

Typical Maintenance Indicator(s) for Filtration BMPs	Maintenance Actions
Accumulation of sediment, litter, or debris	Remove and properly dispose of accumulated materials.
Obstructed inlet or outlet structure	Clear obstructions.
Clogged filter media	Remove and properly dispose of filter media and replace with fresh media.
Damage to components of the filtration system	Repair or replace as applicable.
Note: For proprietary media filters, refer to the manufacturer's maintenance guide.	

7.7.4 Maintenance of Detention BMPs

"Detention BMPs" include basins, cisterns, vaults, and underground galleries that are primarily designed to store runoff for controlled release to downstream systems. For the maintenance discussion, this category does not include an infiltration component (refer to "vegetated infiltration or filtration BMPs" or "non-vegetated infiltration BMPs" above). Applicable fact sheets may include HU-1 (Cistern) or FT-4 (Extended Detention Basin). There are many possible configurations of aboveground and underground detention BMPs, including both proprietary and non-proprietary systems. The project civil engineer is responsible for determining which maintenance indicators and actions listed in Table 7-5 are applicable based on the components of the structural BMP.

TABLE 7-5. Maintenance Indicators and Actions for Detention BMPs

Typical Maintenance Indicator(s) for Detention Basins	Maintenance Actions
Poor vegetation establishment	Re-seed/re-establish vegetation.
Overgrown vegetation	Mow or trim as appropriate.
Erosion due to concentrated irrigation flow	Repair/re-seed/re-plant eroded areas and adjust the irrigation system.
Erosion due to concentrated storm water runoff flow	Repair/re-seed/re-plant eroded areas and make appropriate corrective measures such as adding erosion control blankets, adding stone at flow entry points, or re-grading where necessary.
Accumulation of sediment, litter, or debris	Remove and properly dispose of accumulated materials.
Standing water	Make appropriate corrective measures such as adjusting the irrigation system, removing obstructions of debris or invasive vegetation, or minor re-grading for proper drainage.
Obstructed inlet or outlet structure	Clear obstructions.
Damage to structural components such as weirs, or inlet or outlet structures	Repair or replace as applicable.

Submittal Requirements

It is necessary for P&EAD to review project plans for compliance with the applicable requirements of this Manual and the MS4 Permit.

The review process must verify that storm water management objectives were considered in the project planning process and that opportunities to incorporate BMPs have been identified. The review process must confirm that the site plan, landscape plan, and project storm water documents are congruent. Therefore, the Authority requires a submittal (i.e., the SWQMP) documenting the storm water management design for every project that is subject to the requirements of this Manual. A complete and thorough project submittal facilitates and expedites the review and approval and may result in fewer submittals by the applicant. This chapter discusses submittal requirements. In all cases, the project applicant must provide sufficient documentation to demonstrate that applicable requirements of this Manual and the MS4 Permit are met.

8.1 Submittal Requirement for Standard Projects

8.1.1 Standard Project SWQMP

For Standard Projects, the project submittal shall include a "Standard Project SWQMP."

The Standard Project SWQMP is a compilation of checklists that document that all permanent source control and site design BMPs have been considered for the project and implemented where feasible. All applicable features shall be shown on site plans and landscaping plans. The Standard Project SWQMP shall consist of the following forms and/or checklists included in Appendix A.3:

- Form H-1: Applicability of Permanent BMP Requirements
- Form H-2: Project Type Determination (Standard Project or PDP)
- Form H-3A: Site Information for Standard Projects
- Form H-4: Source Control BMP Checklist for All Development Projects
- Form H-5: Site Design BMP Checklist for All Development Projects

The Standard Project SWQMP shall also include copies of the relevant plan sheets showing source control and site design BMPs.

8.2 Submittal Requirements for PDPs

8.2.1 PDP SWQMP

For PDPs, the project submittal shall include a "PDP SWQMP."

The PDP SWQMP shall document that all permanent source control and site design BMPs have been considered for the project and implemented where feasible; document the planning process and the decisions that led to the selection of structural BMPs; provide the calculations for design of structural BMPs to demonstrate that applicable performance standards are met by the structural BMP design; identify O&M requirements of the selected structural BMPs; and identify the maintenance mechanism (see Sections 7.2 and 7.3) for long-term O&M of structural BMPs. PDPs shall use the PDP SWQMP Template provided in Appendix A.4, which includes forms and/or checklists, project intake and source control BMP documentation, and checklists for documentation of pollutant control structural BMP design. The PDP SWQMP shall include copies of the relevant plan sheets showing site design, source control, structural BMPs, and structural BMP maintenance requirements.

A PDP SWQMP must be provided with the first submittal of a project application.

Storm water requirements directly affect the layout of the project. Storm water requirements must be considered from the initial project planning or in project concept stage, and are reviewed upon each submittal, beginning with the first submittal. The process from initial project application through approval of the project plans often includes design changes to the site layout and features. Changes may be driven by storm water management requirements or other site requirements. Each time the site layout is adjusted, whether the adjustment is directly due to storm water management requirements identified during P&EAD review of the storm water submittal or is driven by other site requirements, the storm water management design must be revisited to ensure that the revised project layout and features meet the requirements of this Manual and the MS4 Permit. An updated PDP SWQMP must be provided with each submittal of revised project plans. The updated PDP SWQMP should include documentation of changes to the site layout and features and reasons for the changes. If other site requirements identified during plan review render certain proposed storm water features infeasible (e.g., if fire department access requirements were identified that precluded use of certain surfaces or landscaping features that had been proposed), this must be documented as part of the decisions that led to the development of the final storm water management design.

Note that additional information may be required at the discretion of the reviewer based on the nature of the project, but at a minimum, the information listed in the submittal template in Appendix A.4 shall be included in the PDP SWQMP.

The Authority requires that the SWQMP be certified by a civil engineer licensed to practice in California.

The certification should state: "The selection, sizing, and preliminary design of storm water treatment and other control measures in this plan meet the requirements of Regional Water Quality Control Board Order R9-2013-0001 and subsequent amendments."

8.2.1.1 PDP O&M Plan

Although the PDP SWQMP must include general O&M requirements for structural BMPs, the PDP SWQMP may not be the final O&M Plan.

The O&M requirements documented in the PDP SWQMP must be sufficient to show that O&M requirements have been considered in the project planning and design. However, a final O&M Plan should reflect actual constructed structural BMPs to be maintained. Photographs and as-built plans for the constructed structural BMPs should be included. Requirements may also vary depending on whether long-term O&M will be furnished by a public agency or private entity. See Section 8.2.3 for project closeout procedures, including Authority requirements for final O&M Plans, and Section 8.2.4 for additional requirements for tenant O&M of structural BMPs.

8.2.2 Requirements for Construction Plans

8.2.2.1 BMP Identification and Display on Construction Plans

Plans for construction of the project (grading plans, improvement plans, and landscaping plans, as applicable) must show all permanent site design, source control, and structural BMPs, and must be congruent with the PDP SWQMP.

When construction plans are submitted for P&EAD review and approval, staff compare that submittal with the earlier SWQMP submittal. Preparation and submittal of the Construction Plan SWQMP Checklist (Table 8-1) for the project facilitates comparisons and likely speed-up review of the project.

TABLE 8-1. Format for Construction Plans SWQMP Checklist

SWQMP Page #	BMP Description	See Plan Sheet #s

Preparation of the Construction Plan SWQMP Checklist:

- 1) Create a table as shown in Table 8-1. Number and list each measure or BMP specified in the SWQMP submittal in Columns 1 and 2 of the table. Leave Column 3 blank. Incorporate the table into the SWQMP submittal.
- 2) When submitting construction plans, duplicate the table (by photocopy or electronically). Now fill in Column 3, identifying the plan sheets where the BMPs are shown. List all plan sheets on which the BMP appears. Submit the updated table with the construction plans.

Note that the updated table—or Construction Plan SWQMP Checklist—is only a reference tool to facilitate comparison of the construction plans with the SWQMP. P&EAD can advise applicants about the process required to propose changes to the approved SWQMP.

8.2.2.2 Structural BMP Maintenance Information on Construction Plans

Plans for construction of the project must provide sufficient information to describe maintenance requirements (thresholds and actions) for structural BMPs so that, if all other separate O&M documents are lost, a new party studying plans for the project could identify the structural BMPs and identify the required maintenance actions based on the plans.

For long-term O&M, the project plans must identify the following:

- Instructions for accessing the structural BMP to inspect and perform maintenance;
- Features that are provided to facilitate inspection (e.g., observation ports, cleanouts, silt posts, or other features that allow the inspector to view necessary components of the structural BMP and compare to maintenance thresholds);
- Manufacturer and part number for proprietary parts;
- Maintenance thresholds specific to the structural BMP, with a location-specific frame of reference (e.g., level of accumulated materials that triggers removal of the materials, to be identified based on viewing marks on silt posts or measured with a survey rod with respect to a fixed benchmark within the BMP);
- Recommended equipment to perform maintenance; and
- When applicable, necessary special training or certification requirements for inspection and maintenance personnel such as confined space entry or hazardous waste management.

8.2.3 Design Changes During Construction and Project Closeout Procedures

8.2.3.1 Design Changes During Construction

Prior to occupancy and/or intended use of any portion of a PDP, the site must be in compliance with the requirements of this Manual and the MS4 Permit.

During construction, any changes that affect the design of storm water management features must be reviewed and approved by P&EAD before work can proceed. Approved documents and additional design may be required prior to implementation of design changes during construction. This might include changes to drainage patterns that occurred based on actual site grading and construction of storm water conveyance structures or substitutions to storm water management features. Just as during the design phase, when there are changes to the site layout and features, the storm water management design must be revisited to ensure that the revised project layout and features meet the requirements of this Manual and the MS4 Permit.

8.2.3.2 Certification of Constructed BMPs

As part of the "Structural BMP Approval and Verification Process" required by the MS4 Permit, each structural BMP must be inspected to verify that it has been constructed and is operating in compliance with all its specifications, plans, permits, and ordinances, and the requirements of the MS4 Permit.

Because some portions of the structural BMP will not be readily visible after completion of construction (e.g., subsurface layers), P&EAD requires inspections during construction, photographs taken during construction, and/or other certification that the BMP has been constructed in conformance with the approved plans.

Prior to occupancy of each PDP, P&EAD, together with a project proponent engineer, inspects each structural BMP to verify that it has been constructed in compliance with all specifications, plans, permits, and ordinances, and records verification and approval of the structural BMPs in the Authority's Web-based database. Initial BMP verification inspections are separate from the regular O&M inspections for each BMP. P&EAD may require forms, as-builts, or other documentation to be submitted prior to the inspection to facilitate the structural BMP inspection.

8.2.3.3 Final O&M Plan

Upon completion of project construction, the local agency may require a final O&M Plan to be submitted.

A final O&M Plan reflects project-specific constructed structural BMPs with project-specific drawings, photographs, and maps, and identifies specific maintenance requirements and actions for the constructed structural BMPs. Specific requirements and review procedures for this process may vary based on the planned maintenance entity (Authority, tenant, or other).

8.2.4 Additional Requirements for Tenant O&M

This section discusses structural BMPs associated with tenant projects to be operated and maintained by tenants as part of their lease agreement.

8.2.4.1 O&M Agreements for Tenant Structural BMP Maintenance

For structural BMPs associated with tenant projects, the Authority requires execution of an O&M Agreement through conditions in the tenant lease.

An O&M Agreement is incorporated in the tenant lease and signed by the Authority and the tenant, committing the tenant to maintain the permanent structural BMPs. The O&M Agreement may provide that, if the tenant fails to maintain the storm water facilities, the Authority may restore the storm water facilities to operable condition and obtain reimbursement, including administrative costs, from the tenant.

This page intentionally left blank

Bibliography

- ASTM International. 2009. ASTM Standard D3385-09. Retrieved from <http://www.astm.org/Standards/D3385.htm>
- Breuer, L., Eckhardt, K, and Frede, H. 2003. Plant Parameter Values for Models in Temperate Climates. *Ecological Modelling*. 169:237-293. November.
- California Department of Water Resources. 1947. Evaporation from Water Surfaces in California, A Summary of Pan Records and Coefficients, 1881 to 1946. Bulletin No. 54. California State Printing Office.
- California Department of Water Resources. 2012. California Irrigation Management Information System Reference Evapotranspiration Zones.
- California Department of Transportation (Caltrans). 1986. Method for Determining the Percolation Rate of Soil Using a 6-inch-diameter Test Hole. California Test 750. http://www.dot.ca.gov/hq/esc/sdsee/wwe/documents/Test_750.pdf
- Cedergren, H.R. 1997. Seepage, drainage, and flow nets, third ed. John Wiley and Sons, Inc., New York.
- Cities and County of Riverside. 2012. Water Quality Management Plan for the Santa Margarita Region of Riverside County.
- City of Los Angeles. 2011. Development Best Management Practices Handbook. Low Impact Development Manual.
- City of Portland. 2008. Storm water Management Manual
- City of San Diego. 2011. Guidelines for Geotechnical Reports.
- City of San Diego. 2011. San Diego Low Impact Development Design Manual.
- City of San Diego. 2012. Storm Water Standards.
- City of Santa Barbara. 2013. Storm Water BMP Guidance Manual.
- Clear Creek Solutions, Inc. 2012. San Diego Hydrology Model (SDHM) User Manual.
- County of Los Angeles Department of Public Works. 2014. Low Impact Development, Standards Manual.
- County of Orange. 2011. Model Water Quality Management Plan (Model WQMP).
- County of Orange. 2011. Technical Guidance Document for the Preparation of Conceptual/Preliminary and/or Project Water Quality Management Plans (WQMPs).
- County of San Bernardino. 1992. Suitability of Lots and Soils for Use of Leachlines or Seepage Pits, Soil Percolation (PERC) Test Report Standards, Onsite Waste Water Disposal System, August 1992.
- County of San Diego. 2003. Stormwater Standards Manual.

- County of San Diego. 2007. Low Impact Development Handbook: Stormwater Management Strategies.
- County of San Diego. 2011. Final Hydromodification Management Plan
- County of San Diego. 2012. County of San Diego Standard Urban Stormwater Mitigation Plan (SUSMP): SUSMP Requirements for Development Applications.
- County of San Diego. 2014. Low Impact Development Handbook: Stormwater Management Strategies.
- County of Ventura. 2011. Ventura County Technical Guidance Manual for Stormwater Quality Control Measures.
- Darcy, H, 1856. Les fontaines publiques de la Ville de Dijon (The public fountains of the City of Dijon). Trans. Patricia Bobeck. Paris: Dalmont. (Kendall/Hunt, 2004) 506 p
- Double Ring Infiltrometer Test (ASTM 3385)-ASTM International. 2009.
- Emerson, C.H. 2008. Evaluation of Infiltration Practices as a Means to Control Stormwater Runoff. Doctoral dissertation, Civil and Environmental Engineering. Villanova University. May 2008.
- Galli, J. 1992. Analysis of urban stormwater BMP performance and longevity in Prince George's County, Maryland. Metropolitan Washington Council of Governments, Washington, D.C.
- Gobel, P. et al. 2004. Near-Natural Stormwater Management and its Effects on the Water Budget and Groundwater Surface in Urban Areas Taking Account of the Hydrogeological Conditions. *Journal of Hydrology* 299, 267-283.
- Gulliver, J., Erickson, A., and Weiss, P. 2010. Optimizing Stormwater Treatment Practices: A Handbook of Assessment and Maintenance.
- Hazen, A. 1892. Some Physical Properties of Sands And Gravels, With Special Reference To Their Use In Filtration. 24th Annual Rep., Massachusetts State Board of Health, Pub. Doc. No. 34, 539-556.
- Hazen, A. 1911. Discussion of Dams On Sand Foundations' by A.C. Koenig. Trans. Am. Soc. Civ. Eng., 73, 199-203
- King County Department of Natural Resources and Parks. 2009. King County, Washington Surface Water Design Manual. Retrieved from <http://your.kingcounty.gov/dnrp/library/water-and-land/stormwater/surface-water-design-manual/SWDM-2009.pdf>
- Lindsey, G., Roberts, L., and Page, W. 1991. Storm Water Management Infiltration. Maryland Department of the Environment, Sediment and Storm Water Administration.
- Lindsey, P. and Bassuk, N. 1991. Specifying Soil Volumes to Meet the Water Needs of Mature Urban Street Trees and Trees in Containers. *Journal of Arboriculture* 17(6): 141-149.
- Minnesota Pollution Control Agency (MPCA). (n.d.). Minnesota Stormwater Manual. Retrieved October 2014 from: http://stormwater.pca.state.mn.us/index.php/Calculating_credits_for_tree_trenches_and_tree_boxes

Bibliography

- Orange County Watersheds Protection Program. 2011. Project-Specific Alternatives to the Interim Sizing Tool.
- Phillips, E., and Kitch, W. 2011. A Review of Methods for Characterization of Site Infiltration with Design Recommendations. *Journal of the Nevada Water Resources Association*, Summer 2011, Vol. 6, No. 1, pp. 29-46.
- Pitt, R., Chen, S., Clark, S., Swenson, J., and Ong, C. 2008. "Compaction's Impacts on Urban Storm-Water Infiltration." *J. Irrig. Drain Eng.* 134, SPECIAL ISSUE: Urban Storm-Water Management, 652–658.
- Riverside County. 2011. Riverside County - Low Impact Development BMP Design Handbook – Appendix A – Infiltration Testing
http://rcflood.org/downloads/NPDES/Documents/LIDManual/Appendix%20A_Infiltration_Testing.pdf
- Riverside County Copermittees. 2014. Santa Margarita Region Hydromodification Management Plan.
- Riverside County Flood Control and Water Conservation District. 2011. Design Handbook for Low Impact Development Best Management Practices.
- Riverside County Percolation Test (2011), California Test 750 (1986), San Bernardino County Percolation Test (1992); USEPA Falling Head Test (1980).
- Rossmann, Lewis A. 2010. Storm Water Management Model (SWMM) User's Manual Version 5.0. EPA/600/R-05/040.
- San Diego County Regional Airport Authority. 2011 (updated 2012). San Diego County Regional Airport Authority SUSMP: Standard Urban Stormwater Mitigation Plan Requirements for Development Applications.
- San Diego County Regional Airport Authority. 2015 (amended 2022). SAN Storm Water Management Plan.
- San Diego County Regional Airport Authority. 2020. Water Quality Equivalency Credit Trading Framework.
- San Diego Regional Copermittees. 2012. San Diego BMP Sizing Calculator Methodology
- San Diego Regional Copermittees. 2014. San Diego County Regional Watershed Management Area Analysis.
- San Diego Regional Copermittees. 2018. Water Quality Equivalency Guidance Document: Region 9.
- San Diego Regional Copermittees. 2018. Model BMP Design Manual.
- Southern California Coastal Water Research Project (SCCWRP). 2010. Hydromodification Screening Tools: Field Manual for Assessing Channel Susceptibility. Brian P. Bledsoe; Robert J. Hawley; Eric D. Stein; Derek B. Booth. Technical Report 606.

Bibliography

- SCCWRP. 2012. Hydromodification Assessment and Management in California. Eric D. Stein; Felicia Federico; Derek B. Booth; Brian P. Bledsoe; Chris Bowles; Zan Rubin; G. Mathias Kondolf and Ashmita Sengupta. Technical Report 667.
- Schwab, G., Fangmeier, D., Elliot, W., and Frevert, R. 1993. Soil and Water Conservation Engineering. Fourth Edition. John Wiley & Sons, Inc.
- Scurlock, J., Asner, G., and Gower, S. 2001. Global Leaf Area Index from Field Measurements, 1932-2000. Data set. Available on-line [<http://www.daac.ornl.gov>] from Oak Ridge National Laboratory Distributed Active Archive Center, Oak Ridge, Tennessee, U.S.A. doi:10.3334/ORNLDAAAC/584.
- United States Department of the Interior, Bureau of Reclamation. 1990. "Procedure for Performing Field Permeability Testing by the Well Permeameter Method (USBR 7300-89)" in Earth Manual, Part 2. Materials Engineering Branch Research and Laboratory Services Division, Denver, Colorado.
- United States Department of the Interior, Bureau of Reclamation. 1993. Drainage Manual: A Water Resources Technical Publication. Retrieved from http://www.usbr.gov/pmts/wquality_land/DrainMan.pdf
- United States Environmental Protection Agency. 2000. BASINS Technical Note 6 – Estimating Hydrology and Hydraulic Parameters for Hydrologic Simulation Program-FORTRAN (HSPF). EPA-823-R00-012.
- Urban Drainage and Flood Control District, Denver, CO. (2010). Urban Storm Drainage Criteria Manual. Volume 3, Best Management Practices.
- United States Department of Interior Bureau of Reclamation. 1993. Drainage Design Manual.
- United States Environmental Protection Agency (USEPA). 1980. Onsite Wastewater Treatment and Disposal Systems (EPA No. 625/1-80-012). Retrieved from nepis.epa.gov/Exe/ZyPURL.cgi?Dockey=300043XO.txt
- USEPA. 1999. Preliminary data summary of urban storm water best management practices. EPA-821-R-99-012, U. S. Environmental Protection Agency, Washington, D.C.
- Washington State Department of Ecology. 2012. Stormwater Management Manual for Western Washington - Volume 3: Hydrologic Analysis and Flow Control BMPs. Retrieved from <https://fortress.wa.gov/ecy/publications/summarypages/1210030.html>



SAN DIEGO
INTERNATIONAL AIRPORT

LET'S GO.

San Diego County Regional Airport Authority BMP Design Manual Appendices

February 2022

wood.

Prepared by:

Geosyntec
consultants

RICK
ENGINEERING COMPANY



project clean water

This page intentionally left blank

Table of Contents

APPENDIX A	AIRPORT AUTHORITY DATA AND SWQMP TEMPLATES	A-1
A.1	ENVIRONMENTALLY SENSITIVE AREAS	A-1
A.2	AIRPORT AUTHORITY FIGURES	A-2
A.3	STANDARD SWQMP TEMPLATE.....	A-8
A.4	PDP SWQMP TEMPLATE.....	A-28
APPENDIX B	STORM WATER POLLUTANT CONTROL HYDROLOGIC CALCULATIONS AND SIZING METHODS .	B-1
B.1	DCV.....	B-1
	<i>B.1.1 Runoff Factor.....</i>	<i>B-2</i>
	<i>B.1.2 Offline BMPs.....</i>	<i>B-2</i>
B.2	ADJUSTMENTS TO ACCOUNT FOR SITE DESIGN BMPs	B-6
	<i>B.2.1 Adjustment to Impervious Runoff Factor</i>	<i>B-6</i>
	<i>B.2.2 Adjustment to DCV.....</i>	<i>B-8</i>
B.3	HARVEST AND USE BMPs	B-11
	<i>B.3.1 Planning Level Harvest and Use Feasibility</i>	<i>B-11</i>
	<i>B.3.2 Harvested Water Demand Calculation.....</i>	<i>B-13</i>
	<i>B.3.3 Sizing Harvest and Use BMPs.....</i>	<i>B-17</i>
B.4	INFILTRATION BMPs	B-18
	<i>B.4.1 Simple Method</i>	<i>B-18</i>
	<i>B.4.2 Percent Capture Method.....</i>	<i>B-19</i>
	<i>B.4.3 Technical Basis for Equivalent Sizing Methods.....</i>	<i>B-24</i>
B.5	BIOFILTRATION BMPs	B-26
	<i>B.5.1 Basis for Minimum Sizing Factor for Biofiltration BMPs</i>	<i>B-29</i>
	<i>B.5.2 Sizing Biofiltration BMPs Downstream of a Storage Unit</i>	<i>B-35</i>
B.6	FLOW-THROUGH TREATMENT CONTROL BMPs (FOR USE WITH ALTERNATIVE COMPLIANCE)	B-38
	<i>B.6.1 PDP Most Significant Pollutants of Concern.....</i>	<i>B-38</i>
	<i>B.6.2 Selection of Flow-Through Treatment Control BMPs.....</i>	<i>B-39</i>
	<i>B.6.3 Sizing Flow-Through Treatment Control BMPs:</i>	<i>B-46</i>
APPENDIX C	GEOTECHNICAL AND GROUNDWATER INVESTIGATION REQUIREMENTS.....	C-1
C.1	PURPOSE AND PHASING	C-1
C.2	GEOTECHNICAL FEASIBILITY CRITERIA	C-3
	<i>C.2.1 Soil and Geologic Conditions.....</i>	<i>C-3</i>
	<i>C.2.2 Settlement and Volume Change.....</i>	<i>C-3</i>
	<i>C.2.3 Slope Stability.....</i>	<i>C-4</i>
	<i>C.2.4 Utility Considerations.....</i>	<i>C-4</i>
	<i>C.2.5 Groundwater Mounding.....</i>	<i>C-4</i>
	<i>C.2.6 Retaining Walls and Foundations</i>	<i>C-4</i>
	<i>C.2.7 Other Factors.....</i>	<i>C-5</i>
C.3	GROUNDWATER QUALITY AND WATER BALANCE FEASIBILITY CRITERIA.....	C-6
	<i>C.3.1 Soil and Groundwater Contamination.....</i>	<i>C-6</i>

C.3.2	<i>Separation to Seasonal High Groundwater</i>	C-6
C.3.3	<i>Wellhead Protection</i>	C-7
C.3.4	<i>Contamination Risks from Land Use Activities</i>	C-7
C.3.5	<i>Consultation with Applicable Groundwater Agencies</i>	C-7
C.3.6	<i>Water Balance Impacts on Stream Flow</i>	C-7
C.3.7	<i>Downstream Water Rights</i>	C-8
C.3.8	<i>Other Factors</i>	C-8
C.4	GEOTECHNICAL AND GROUNDWATER INVESTIGATION REPORT REQUIREMENTS.....	C-9
C.4.1	<i>Site Evaluation</i>	C-9
C.4.2	<i>Field Investigation</i>	C-9
C.4.3	<i>Reporting Requirements by Geotechnical Engineer</i>	C-10
C.4.4	<i>Reporting Requirements by the Project Design Engineer</i>	C-11
C.5	FEASIBILITY SCREENING EXHIBITS.....	C-16
APPENDIX D	APPROVED INFILTRATION RATE ASSESSMENT METHODS FOR SELECTION AND DESIGN OF	
STORM WATER BMPS		D-1
D.1	INTRODUCTION.....	D-1
D.2	ROLE OF INFILTRATION TESTING IN DIFFERENT STAGES OF PROJECT DEVELOPMENT.....	D-1
D.3	GUIDANCE FOR SELECTING INFILTRATION TESTING METHODS.....	D-2
D.3.1	<i>Desktop Approaches and Data Correlation Methods</i>	D-4
D.3.2	<i>Surface and Shallow Excavation Methods</i>	D-5
D.3.3	<i>Deeper Subsurface Tests</i>	D-8
D.4	SPECIFIC CONSIDERATIONS FOR INFILTRATION TESTING.....	D-10
D.4.1	<i>Hydraulic Conductivity Versus Infiltration Rate Versus Percolation Rate</i>	D-10
D.4.2	<i>Cut and Fill Conditions</i>	D-10
D.4.3	<i>Effects of Direct and Incidental Compaction</i>	D-11
D.4.4	<i>Temperature Effects on Infiltration Rate</i>	D-12
D.4.5	<i>Number of Infiltration Tests Needed</i>	D-13
D.5	SELECTING A SAFETY FACTOR.....	D-14
D.5.1	<i>Determining Factor of Safety</i>	D-14
D.5.2	<i>Site Suitability Considerations for Selection of an Infiltration Factor of Safety</i>	D-15
D.5.3	<i>Design Related Considerations for Selection of an Infiltration Factor of Safety</i>	D-16
D.5.4	<i>Implications of a Factor of Safety in BMP Feasibility and Design</i>	D-17
APPENDIX E	BMP DESIGN FACT SHEETS	E-1
E.1	FACT SHEET QUICK GUIDE.....	E-2
E.2	SOURCE CONTROL BMP REQUIREMENTS.....	E-4
E.3	SD-Q LARGE TRASH GENERATING FACILITIES.....	E-16
E.4	SD-A TREE WELL.....	E-20
E.5	SD-B IMPERVIOUS AREA DISPERSION.....	E-28
E.6	SD-C: GREEN ROOFS.....	E-36
E.7	SD-D PERMEABLE PAVEMENT (SITE DESIGN BMP).....	E-44
E.8	SD-E RAIN BARRELS.....	E-52
E.9	SD-F AMENDED SOILS.....	E-56

E.10	HU-1 CISTERN	E-58
E.11	INF-1 INFILTRATION BASIN.....	E-68
E.12	INF-2 BIORETENTION	E-78
E.13	INF-3 PERMEABLE PAVEMENT (POLLUTANT CONTROL).....	E-92
E.14	PR-1 BIOFILTRATION WITH PARTIAL RETENTION	E-106
E.15	BF-1 BIOFILTRATION	E-120
E.16	BF-2 NUTRIENT SENSITIVE MEDIA DESIGN	E-134
E.17	BF-3 PROPRIETARY BIOFILTRATION SYSTEMS	E-137
E.18	FT-1 VEGETATED SWALES	E-138
E.19	FT-2 MEDIA FILTERS	E-148
E.20	FT-3 SAND FILTERS	E-156
E.21	FT-4 DRY EXTENDED DETENTION BASIN.....	E-164
E.22	FT-5 PROPRIETARY FLOW-THROUGH TREATMENT CONTROL BMPs	E-174
E.23	PL PLANT LIST	E-176
APPENDIX F	BIOFILTRATION STANDARD AND CHECKLIST	F-1
F.1	POLLUTANT TREATMENT PERFORMANCE STANDARD.....	F-8
F.2	GUIDANCE ON SIZING AND DESIGN OF NON-STANDARD BIOFILTRATION BMPs	F-12
	<i>F.2.1 Guidance on Design per Conditions of Certification/Verification.....</i>	<i>F-12</i>
	<i>F.2.2 Sizing of Flow-Based Biofiltration BMP</i>	<i>F-12</i>
APPENDIX G	GUIDANCE FOR CONTINUOUS SIMULATION AND HYDROMODIFICATION MANAGEMENT SIZING FACTORS	G-1
G.1	GUIDANCE FOR CONTINUOUS SIMULATION HYDROLOGIC MODELING FOR HYDROMODIFICATION MANAGEMENT STUDIES IN SAN DIEGO COUNTY REGION 9.....	G-1
	<i>G.1.1 Introduction.....</i>	<i>G-1</i>
	<i>G.1.2 Software for Continuous Simulation Hydrologic Modeling</i>	<i>G-2</i>
	<i>G.1.3 Climatology Parameters.....</i>	<i>G-2</i>
	<i>G.1.4 LAND CHARACTERISTICS AND LOSS PARAMETERS.....</i>	<i>G-8</i>
	<i>G.1.5 MODELING STRUCTURAL BMPs (PONDS AND LID FEATURES).....</i>	<i>G-19</i>
	<i>G.1.6 FLOW FREQUENCY AND DURATION.....</i>	<i>G-26</i>
G.2	SIZING FACTORS FOR HYDROMODIFICATION MANAGEMENT BMPs	G-30
	<i>G.2.1 Unit Runoff Ratios</i>	<i>G-36</i>
	<i>G.2.2 Sizing Factors for "Infiltration" BMP</i>	<i>G-39</i>
	<i>G.2.3 Sizing Factors for Bioretention with Partial Retention</i>	<i>G-41</i>
	<i>G.2.4 Sizing Factors for Biofiltration</i>	<i>G-44</i>
	<i>G.2.5 Sizing Factors for Biofiltration with Impermeable Liner</i>	<i>G-47</i>
	<i>G.2.6 Sizing Factors for "Cistern" BMP</i>	<i>G-52</i>
APPENDIX H	FORMS AND CHECKLISTS	H-1
APPENDIX I	USEPA GREEN STREETS HANDBOOK	I-1
APPENDIX J	ALTERNATIVE COMPLIANCE PROGRAM.....	J-1
	J.1 PREREQUISITES TO PROGRAM DEVELOPMENT	J-1

AUTHORITY BMP DESIGN MANUAL

J.1.1 Watershed Management Area Analysis..... J-1
J.1.2 Water Quality Equivalency..... J-2
J.2 ALTERNATIVE COMPLIANCE OPTIONS J-3
J.2.1 General Requirements..... J-3
J.2.2 Phase I..... J-4
J.2.3 Phase II..... J-4

GLOSSARY OF KEY TERMS I

Appendix

A

AUTHORITY BMP DESIGN MANUAL

Airport Authority Data and SWQMP Templates

Appendix A Airport Authority Data and SWQMP Templates

Appendix A contains tables, figures, and templates prepared to assist project applicants develop their Storm Water Quality Management Plans (SWQMPs). The following sections are included:

- Section A.1 Environmentally Sensitive Areas (ESAs): This section describes receiving water conditions applicable to storm water drainage from the San Diego International Airport (SAN). A table of Clean Water Act Section 303(d) listings is provided.
- Section A.2 Authority Figures: This section contains the following figures to assist project applicants:
 - Figure A.2-1 San Diego International Airport Storm Drain System: Shows storm drain lines and drainage basins at SAN.
 - Figure A.2-2 San Diego International Airport Land Uses: Displays industrial, commercial, and San Diego Regional Airport Authority (Authority) land use areas at SAN.
 - Figure A.2-3 Receiving Waters and Conveyance Systems Exempt from Hydromodification Management Requirements: Displays the conveyance systems at SAN that are concrete lined to the point of discharge in San Diego Bay and thus are exempt from hydromodification management requirements.
 - Figure A.2-4 Potential Critical Coarse Sediment Yield Areas: Displays potential critical coarse sediment yield areas in the San Diego Bay Watershed Management Area and at SAN.
- Section A.3 Standard SWQMP Template: This checklist was developed to assist the project applicant and plan reviewer of a Standard Project.
- Section A.4 Priority Development Project (PDP) SWQMP Template: This checklist was developed to assist the project applicant and plan reviewer of a PDP. It includes an example Tenant Condition of Approval that may be used in a tenant lease agreement to assure storm water best management practice (BMP) maintenance, repair, and replacement for tenant projects.

A.1 Environmentally Sensitive Areas

The project applicant should consider receiving water quality during the project planning stage and during selection of structural BMPs. Specifically, BMPs selected for PDPs should be designed to reduce concentrations of the most significant pollutants of concern.

Storm water from SAN drains to San Diego Bay, portions of which are currently 303(d) listed for impacts because of polychlorinated biphenyls (PCBs), indicator bacteria, and metals, as well as benthic community effects and sediment toxicity. The 2014/2016 303(d) list includes copper as a pollutant

Appendix A: Airport Authority Data and SWQMP Templates

impacting water quality in the marinas along Harbor Island and PCBs as a pollutant impacting water quality throughout San Diego Bay. Runoff from SAN commingles with runoff from other sources and discharges into the waters along Harbor Island. There are four Toxic Hot Spots in San Diego Bay, one of which (the Downtown Anchorage, near the foot of Grape Street) is located near outfalls associated with runoff commingled from SAN and other sources. This area is currently the subject of an Investigative Order issued by the California Regional Water Quality Control Board, San Diego Region (SDRWQCB). The Water Quality Control Plan for the San Diego Basin (Basin Plan) designates San Diego Bay in its entirety as having Rare, Threatened, or Endangered Species beneficial use (RARE). Both the Sweetwater Marsh National Wildlife Refuge and the South Bay Unit of the San Diego National Wildlife Refuge are considered Areas of Special Biological Significance (ASBS), but neither is within proximity to SAN.

ESAs, as designated in the 2014/2016 303(d) list, and their corresponding pollutants of concern are presented in Table A.1-1.

Table A.1-1. Environmentally Sensitive Areas and Pollutants of Concern

Receiving Water	Segment Name	Pollutant of Concern
San Diego Bay	San Diego Bay	Mercury, PAHs (polycyclic aromatic hydrocarbons), PCBs (polychlorinated biphenyls)
	San Diego Bay Shoreline, at Harbor Island (West Basin)	Copper
	San Diego Bay Shoreline, at Harbor Island (East Basin)	Copper
	San Diego Bay Shoreline, at Spanish Landing	Indicator Bacteria
	San Diego Bay Shoreline, at Downtown Anchorage	Benthic Community Effects and Sediment Toxicity

A.2 Airport Authority Figures

This section contains Authority-specific figures to assist project applicants:

Figure A.2-1 shows existing storm drain lines and drainage basins at SAN. Project applicants may use this map to determine current drainage patterns during the preliminary project planning stage. It is the responsibility of the applicant, in consultation with the Authority Planning and Environmental Affairs Department (P&EAD) and Airport Design and Construction (ADC), to verify the location of the

Appendix A: Airport Authority Data and SWQMP Templates

existing storm drain system as the project progresses (e.g., using a Global Positioning System [GPS] unit).

Figure A.2-2 displays the current land uses at SAN. Land uses can be broken down into tenant industrial areas such as terminals; Airport Authority industrial areas such as materials storage yards; commercial areas such as front-of-house passenger walkways and concessions staging areas; and ground transportation areas such as parking lots. Appendix B of the Authority BMP Design Manual (Manual) includes a table detailing the general pollutant categories associated with PDP land uses. An extended discussion of potential pollutants associated with land uses at SAN is provided in Sections 6 and 7 of the SAN Storm Water Management Plan (SWMP).

Figure A.2-3 shows the existing storm drain lines and conveyance systems at SAN that are concrete lined and discharge directly to a water body that is exempt from hydromodification management requirements (San Diego Bay). Because all conveyance systems at SAN are concrete lined, and there are no natural streams or conveyances, all existing storm drain lines are exempt from hydromodification management requirements.

Figure A.2-4 displays the potential critical coarse sediment yield areas in the San Diego Bay Watershed Management Area, as determined during development of the Watershed Management Area Analysis (WMAA). There are no potential critical coarse sediment yield areas at SAN.

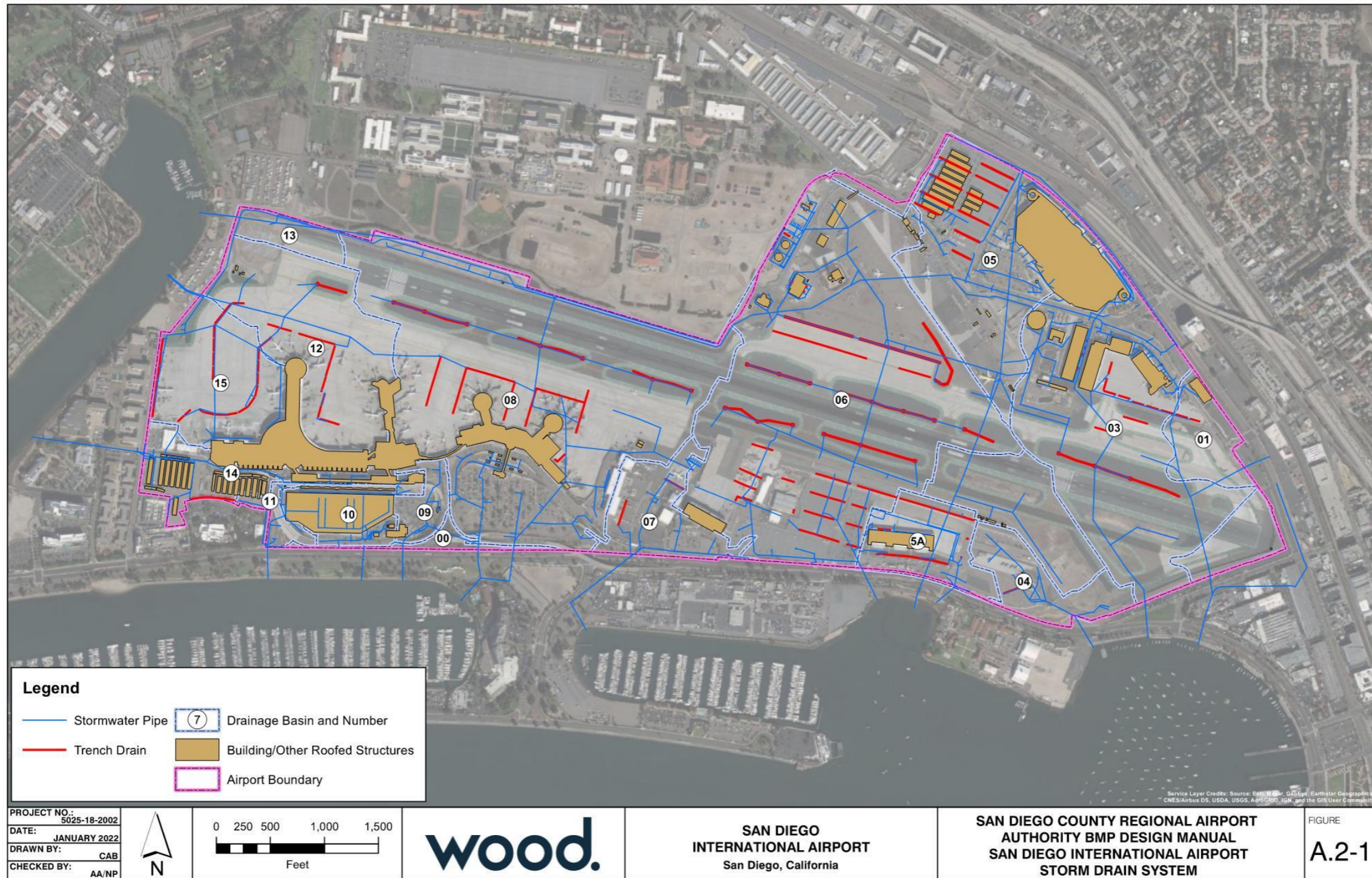

Figure A.2-1: San Diego International Airport Storm Drain System



Figure A.2-2: San Diego International Airport Land Uses

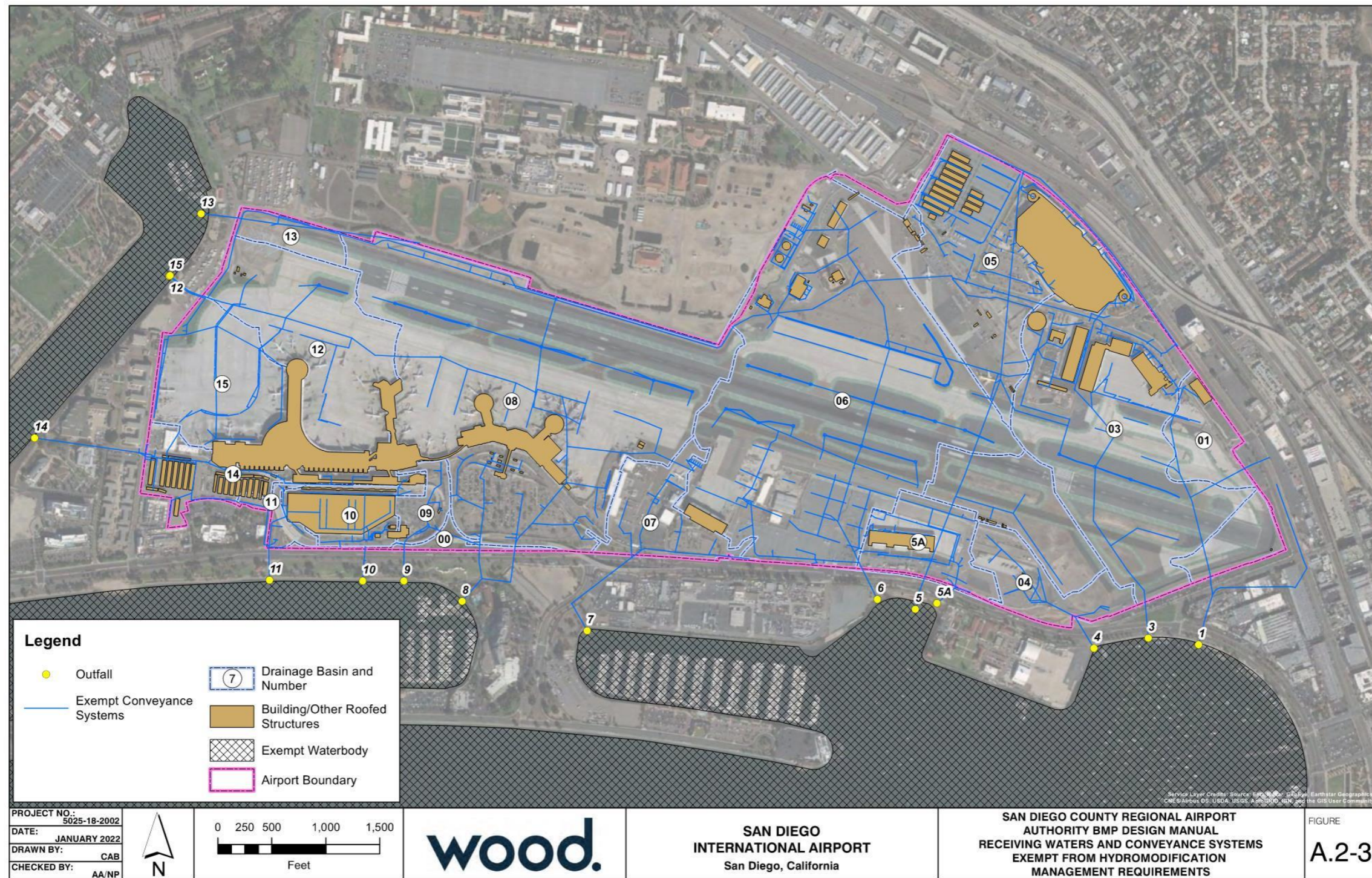

Figure A.2-3: Receiving Waters and Conveyance Systems Exempt from Hydromodification Management Requirements

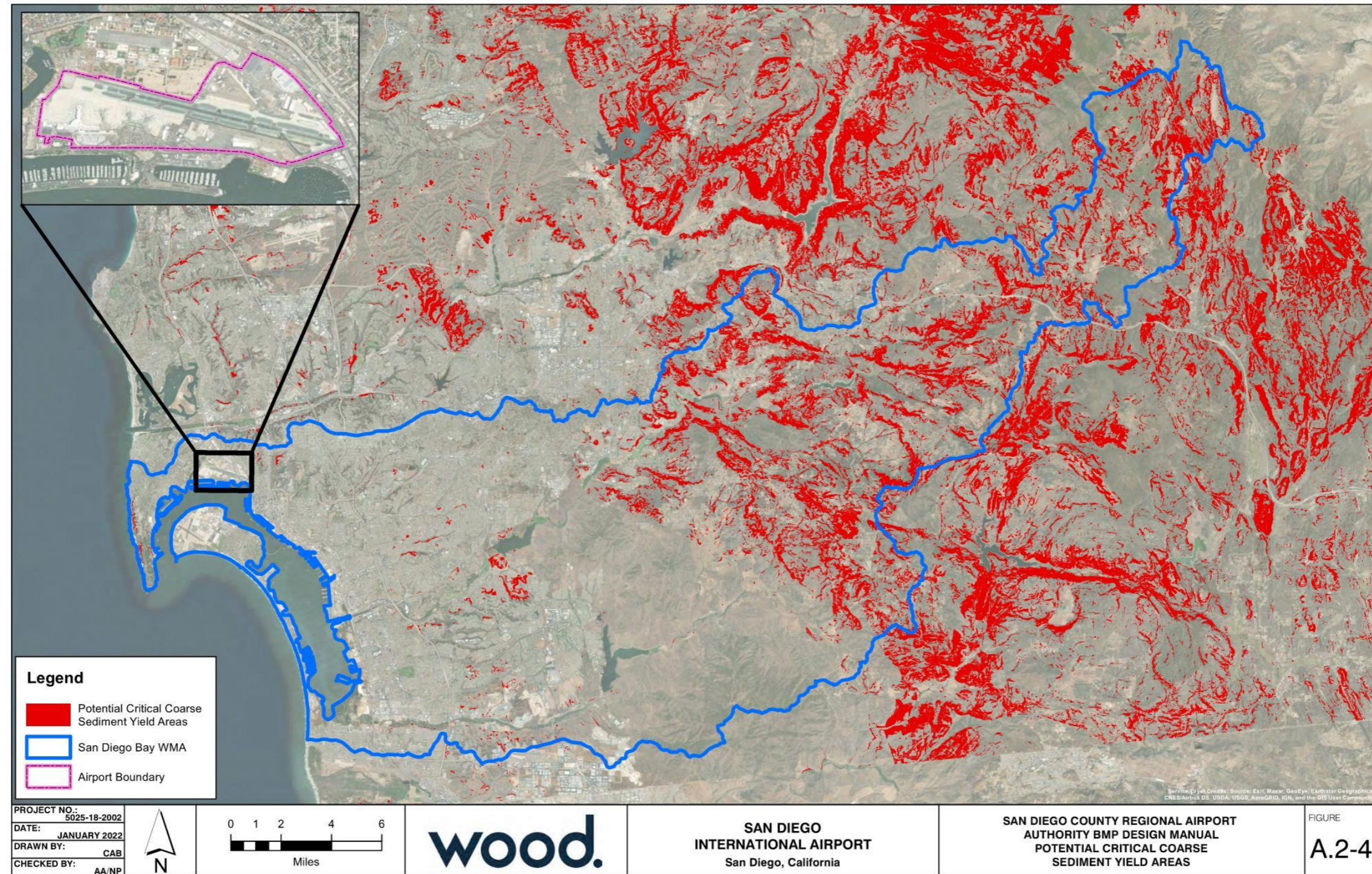

Figure A.2-4: Potential Critical Coarse Sediment Yield Areas

A.3 Standard SWQMP Template

The following template is provided for use by a Standard SWQMP applicant or reviewer. It is not intended to replace a thorough review of the Manual and all appendices.

<p>SAN DIEGO COUNTY REGIONAL AIRPORT AUTHORITY STANDARD (MINOR) DEVELOPMENT PROJECT STORM WATER QUALITY MANAGEMENT PLAN (SWQMP) FOR [INSERT PROJECT NAME] [INSERT PERMIT APPLICATION NUMBERS]</p> <p>[INSERT PROJECT ADDRESS] [INSERT PROJECT CITY, STATE ZIP CODE]</p> <p>ASSESSOR'S PARCEL NUMBER(S): [INSERT APN(S)]</p>

PREPARED FOR:

[INSERT APPLICANT NAME]
[INSERT ADDRESS]
[INSERT CITY, STATE ZIP CODE]
[INSERT TELEPHONE NUMBER]

STANDARD PROJECT SWQMP PREPARED BY:

[INSERT COMPANY NAME]
[INSERT ADDRESS]
[INSERT CITY, STATE ZIP CODE]
[INSERT TELEPHONE NUMBER]

DATE OF SWQMP:
[INSERT MONTH, DAY, YEAR]

PLANS PREPARED BY:
[INSERT CIVIL ENGINEER OR ARCHITECT]
[INSERT ADDRESS]
[INSERT CITY, STATE ZIP CODE]
[INSERT TELEPHONE NUMBER]

Appendix A: Airport Authority Data and SWQMP Templates

TABLE OF CONTENTS

Acronym Sheet
Standard Project SWQMP Project Owner's Certification Page
Project Vicinity Map
FORM H-1 Applicability of Permanent, Post-Construction Storm Water BMP Requirements
FORM H-2 Project Type Determination (Standard Project or PDP) Checklist
FORM H-3A Site Information Checklist for Standard Projects
FORM H-4 Source Control BMP Checklist for All Development Projects
FORM H-5 Site Design BMP Checklist for All Development Projects
Attachment 1: Copy of Plan Sheets Showing Permanent Storm Water BMPs

Appendix A: Airport Authority Data and SWQMP Templates

ACRONYMS

APN	Assessor's Parcel Number
BMP	Best Management Practice
HMP	Hydromodification Management Plan
HSG	Hydrologic Soil Group
MS4	Municipal Separate Storm Sewer System
N/A	Not Applicable
NRCS	Natural Resources Conservation Service
PDP	Priority Development Project
PE	Professional Engineer
SC	Source Control
SD	Site Design
SDRWQCB	San Diego Regional Water Quality Control Board
SIC	Standard Industrial Classification
SWQMP	Storm Water Quality Management Plan

STANDARD PROJECT SWQMP PROJECT OWNER'S CERTIFICATION PAGE

Project Name: [Insert Project Name]

Permit Application Number: [Insert Permit Application Number]

PROJECT OWNER'S CERTIFICATION

This Standard Project SWQMP has been prepared for [INSERT PROJECT OWNER'S COMPANY NAME] by [INSERT SWQMP PREPARER'S COMPANY NAME]. The Standard Project SWQMP is intended to comply with the Standard Project requirements of the San Diego County Regional Airport Authority BMP Design Manual, which is a design manual for compliance with local San Diego County Regional Airport Authority and regional municipal separate storm sewer system MS4 Permit (California Regional Water Quality Control Board San Diego Region Order No. 2013-0001, as amended by Order No. R9-2015-0001 and R9-2015-0100) requirements for storm water management.

The undersigned, while it owns the subject property, is responsible for the implementation of the provisions of this plan. Once the undersigned transfers its interests in the property, its successor-in-interest shall bear the aforementioned responsibility to implement the best management practices (BMPs) described within this plan. A signed copy of this document shall be available on the subject property into perpetuity.

Project Owner's Signature

Print Name

Company

Date

Appendix A: Airport Authority Data and SWQMP Templates

SUBMITTAL RECORD

Use this Table to keep a record of submittals of this Standard Project SWQMP. Each time the Standard Project SWQMP is re-submitted, provide the date and status of the project. In column 4 summarize the changes that have been made or indicate if response to plan check comments is included. When applicable, insert response to plan check comments behind this page.

Submittal Number	Date	Project Status	Summary of Changes
1		<input type="checkbox"/> Preliminary Design/Planning/CEQA <input type="checkbox"/> Final Design	Initial Submittal
2		<input type="checkbox"/> Preliminary Design/Planning/CEQA <input type="checkbox"/> Final Design	
3		<input type="checkbox"/> Preliminary Design/Planning/CEQA <input type="checkbox"/> Final Design	
4		<input type="checkbox"/> Preliminary Design/Planning/CEQA <input type="checkbox"/> Final Design	

Appendix A: Airport Authority Data and SWQMP Templates

PROJECT VICINITY MAP

Project Name: [Insert Project Name]

Permit Application Number: [Insert Permit Application Number]

[Insert Project Vicinity Map here]

Appendix A: Airport Authority Data and SWQMP Templates

Form H-1 Applicability of Permanent, Post-Construction Storm Water BMP Requirements (Storm Water Intake Form for all Development Permit Applications)		
Project Identification		
Project Name:		
Permit Application Number:		Date:
Determination of Requirements		
<p>The purpose of this form is to identify permanent, post-construction requirements that apply to the project. This form serves as a short <u>summary</u> of applicable requirements, in some cases referencing separate forms that will serve as the backup for the determination of requirements.</p> <p>Answer each step below, starting with Step 1 and progressing through each step until reaching "Stop". Refer to the Manual sections and/or separate forms referenced in each step below.</p>		
Step	Answer	Progression
Step 1: Is the project a "development project"? See Section 1.3 of the Manual for guidance.	<input type="checkbox"/> Yes	Go to Step 2.
	<input type="checkbox"/> No	Stop. Permanent BMP requirements do not apply. No SWQMP will be required. Provide discussion below.
Discussion/justification if the project is <u>not</u> a "development project" (e.g., the project includes <i>only</i> interior remodels within an existing building):		
Step 2: Is the project a Standard Project, PDP, or exception to PDP definitions? To answer this item, see Section 1.4 of the Manual <i>in its entirety</i> for guidance, AND complete Form H-2, Project Type Determination.	<input type="checkbox"/> Standard Project	Stop. Standard Project requirements apply, including Standard Project SWQMP.
	<input type="checkbox"/> PDP	PDP requirements apply, including PDP SWQMP. Go to Step 3.
	<input type="checkbox"/> Exception to PDP definitions	Stop. Standard Project requirements apply. Provide discussion and list any additional requirements below. Prepare Standard Project SWQMP.
Discussion/justification, and additional requirements for exceptions to PDP definitions, if applicable:		

Appendix A: Airport Authority Data and SWQMP Templates

Form H-1 Page 2 of 2		
Step	Answer	Progression
Step 3. Do hydromodification control requirements apply? See Section 1.6 of the Manual for guidance. <u>Note: Hydromodification control requirements do not apply to projects within Airport Authority jurisdiction that drain through concrete lined channels or conveyances that discharge directly to San Diego Bay.</u>	<input type="checkbox"/> Yes	PDP structural BMPs required for pollutant control (Chapter 5) and hydromodification control (Chapter 6). Go to Step 4.
	<input type="checkbox"/> No	Stop. PDP structural BMPs required for pollutant control (Chapter 5) only. Provide brief discussion of exemption to hydromodification control below.
Discussion/justification if hydromodification control requirements do <u>not</u> apply:		
Step 4. Does protection of critical coarse sediment yield areas apply? See Section 6.2 of the Manual for guidance. <u>Note: Critical coarse sediment yield areas are not present within Airport Authority jurisdiction. See Section 1.6 and Appendix A of the Manual.</u>	<input type="checkbox"/> Yes	Management measures required for protection of critical coarse sediment yield areas (Chapter 6.2). Stop.
	<input type="checkbox"/> No	Management measures not required for protection of critical coarse sediment yield areas. Provide brief discussion below. Stop.
Discussion/justification if protection of critical coarse sediment yield areas does <u>not</u> apply:		

Appendix A: Airport Authority Data and SWQMP Templates

Form H-2 Project Type Determination Checklist			
Project Information			
Project Name:			
Permit Application Number:			
Project Type Determination: Standard Project or PDP			
The project is (select one): <input type="checkbox"/> New Development <input type="checkbox"/> Redevelopment			
The total proposed newly created or replaced impervious area is: _____ ft ² (_____) acres			
Is the project in any of the following categories, (a) through (f)?			
Yes <input type="checkbox"/>	No <input type="checkbox"/>	(a)	New development projects that create 10,000 square feet or more of impervious surfaces (collectively over the entire project site). This includes commercial, industrial, mixed-use, and public development projects on public or private land.
Yes <input type="checkbox"/>	No <input type="checkbox"/>	(b)	Redevelopment projects that create and/or replace 5,000 square feet or more of impervious surface (collectively over the entire project site on an existing site of 10,000 square feet or more of impervious surfaces). This includes commercial, industrial, mixed-use, and public development projects on public or private land.
Yes <input type="checkbox"/>	No <input type="checkbox"/>	(c)	<p>New and redevelopment projects that create and/or replace 5,000 square feet or more of impervious surface (collectively over the entire project site), and support one or more of the following uses:</p> <ul style="list-style-type: none"> (i) Restaurants. This category is defined as a facility that sells prepared foods and drinks for consumption, including stationary lunch counters and refreshment stands selling prepared foods and drinks for immediate consumption SIC code 5812). (ii) Parking lots. This category is defined as a land area or facility for the temporary parking or storage of motor vehicles used personally, for business, or for commerce. (iii) Streets, roads, highways, freeways, and driveways. This category is defined as any paved impervious surface used for the transportation of automobiles, trucks, motorcycles, and other vehicles.

Appendix A: Airport Authority Data and SWQMP Templates

Form H-2 Page 2 of 2			
Yes <input type="checkbox"/>	No <input type="checkbox"/>	(d)	<p>New or redevelopment projects that create and/or replace 2,500 square feet or more of impervious surface (collectively over the entire project site) and discharging directly to an Environmentally Sensitive Area (ESA). “Discharging directly to” includes flow that is conveyed overland a distance of 200 feet or less from the project to the ESA or conveyed in a pipe or open channel any distance as an isolated flow from the project to the ESA (i.e., not commingled with flows from adjacent lands).</p> <p><u>Note: ESAs are areas that include but are not limited to all Clean Water Act Section 303(d) impaired water bodies; areas designated as Areas of Special Biological Significance by the State Water Board and SDRWQCB; State Water Quality Protected Areas; water bodies designated with the RARE beneficial use by the State Water Board and SDRWQCB; and any other equivalent environmentally sensitive areas which have been identified by the Copermittees. See Manual Section 1.4.2 for additional guidance and Appendix A.</u></p>
Yes <input type="checkbox"/>	No <input type="checkbox"/>	(e)	<p>New development projects, or redevelopment project that create and/or replace 5,000 ft² or more of impervious surface, that support one or more of the following uses:</p> <ul style="list-style-type: none"> (i) Automotive repair shops. This category is defined as a facility that is categorized in any one of the following SIC codes: 5013, 5014, 5541, 7532-7534, or 7536-7539. (ii) Retail gasoline outlets. This category includes retail gasoline outlets that meet the following criteria: (a) 5,000 square feet or more or (b) a projected Average Daily Traffic of 100 or more vehicles per day.
Yes <input type="checkbox"/>	No <input type="checkbox"/>	(f)	<p>New or redevelopment projects that result in the disturbance of one or more acres of land and are expected to generate pollutants post construction.</p> <p><i>Note: See Manual Section 1.4.2 for additional guidance.</i></p>
<p>Does the project meet the definition of one or more of the PDP categories (a) through (f) listed above?</p> <p><input type="checkbox"/> No – the project is not a PDP (Standard Project).</p> <p><input type="checkbox"/> Yes – the project is a PDP.</p>			
<p>The following is for redevelopment PDPs only:</p> <p>The area of existing (pre-project) impervious area at the project site is: _____ ft² (A)</p> <p>The total proposed newly created or replaced impervious area is: _____ ft² (B)</p> <p>Percent impervious surface created or replaced (B/A)*100: _____%</p> <p>The percent impervious surface created or replaced is (select one based on the above calculation):</p> <p><input type="checkbox"/> less than or equal to fifty percent (50%) – only new impervious areas are considered PDP</p> <p>OR</p> <p><input type="checkbox"/> greater than fifty percent (50%) – the entire project site is a PDP</p>			
Form H-3A (Standard Projects)			
Site Information Checklist for Standard Projects			
Project Summary Information			
Project Name			

Appendix A: Airport Authority Data and SWQMP Templates

Project Address	
Assessor's Parcel Number(s)	
Permit Application Number	
Project Watershed (Hydrologic Unit)	<input type="checkbox"/> Pueblo San Diego 908
Parcel Area (Total area of Assessor's Parcel(s) associated with the project)	_____ Acres (_____ Square Feet)
Area to be disturbed by the project (Project Area)	_____ Acres (_____ Square Feet)
Project Proposed Impervious Area (Subset of Project Area)	_____ Acres (_____ Square Feet)
Project Proposed Pervious Area (subset of Project Area)	_____ Acres (_____ Square Feet)
Note: Proposed Impervious Area + Proposed Pervious Area = Area to be Disturbed by the Project. This may be less than the Parcel Area.	

Appendix A: Airport Authority Data and SWQMP Templates

Form H-3A Page 2 of 4	
Description of Existing Site Condition and Drainage Patterns	
<p>Current Status of the Site (select all that apply)</p> <p><input type="checkbox"/> Existing development</p> <p><input type="checkbox"/> Previously graded but not built out</p> <p><input type="checkbox"/> Agricultural or other non-impervious use</p> <p><input type="checkbox"/> Vacant, undeveloped/natural</p> <p>Description/Additional Information</p>	
<p>Existing Land Cover Includes (select all that apply)</p> <p><input type="checkbox"/> Vegetative Cover</p> <p><input type="checkbox"/> Non-Vegetated Pervious Areas</p> <p><input type="checkbox"/> Impervious Areas</p> <p>Description/Additional Information</p>	
<p>Underlying Soil belongs to Hydrologic Soil Group (HSG) (select all that apply):</p> <p><input type="checkbox"/> NRCS Type A</p> <p><input type="checkbox"/> NRCS Type B</p> <p><input type="checkbox"/> NRCS Type C</p> <p><input type="checkbox"/> NRCS Type D</p>	
<p>Existing Natural Hydrologic Features (select all that apply)</p> <p><input type="checkbox"/> Watercourses</p> <p><input type="checkbox"/> Seeps</p> <p><input type="checkbox"/> Springs</p> <p><input type="checkbox"/> Wetlands</p> <p><input type="checkbox"/> None</p> <p>Description/Additional Information</p>	
<p>Description of Existing Site Drainage [How is storm water runoff conveyed from the site? At a minimum, this description should answer (1) whether existing drainage conveyance is natural or urban; (2) describe existing constructed storm water conveyance systems, if applicable; and (3) is runoff from offsite conveyed through the site? If so, describe.]</p>	

Appendix A: Airport Authority Data and SWQMP Templates

Form H-3A Page 3 of 4	
Description of Proposed Site Development and Drainage Patterns	
Project Description/Proposed Land Use and/or Activities	
List proposed impervious features of the project (e.g., buildings, roadways, parking lots, courtyards, athletic courts, other impervious features)	
List proposed pervious features of the project (e.g., landscape areas)	
Does the project include grading and changes to site topography? <input type="checkbox"/> Yes <input type="checkbox"/> No Description/Additional Information	
Does the project include changes to site drainage (e.g., installation of new storm water conveyance systems)? <input type="checkbox"/> Yes <input type="checkbox"/> No Description/Additional Information	

Appendix A: Airport Authority Data and SWQMP Templates

Form H-3A Page 4 of 4

Identify whether any of the following features, activities, and/or pollutant source areas will be present (select all that apply)

- Onsite storm drain inlets
- Interior floor drains and elevator shaft sump pumps
- Interior parking garages
- Need for future indoor & structural pest control
- Landscape/outdoor pesticide use
- Pools, spas, ponds, decorative fountains, and other water features
- Food service
- Refuse areas
- Industrial processes
- Outdoor storage of equipment or materials
- Vehicle and equipment cleaning
- Vehicle/equipment repair and maintenance
- Fuel dispensing areas
- Loading docks
- Fire sprinkler test water
- Miscellaneous drain or wash water
- Plazas, sidewalks, parking lots, ramps, taxiways, and runways

Appendix A: Airport Authority Data and SWQMP Templates

Form H-4 Source Control BMP Checklist for All Development Projects (Standard Projects and PDPs)			
Project Identification			
Project Name			
Permit Application Number			
Source Control BMPs			
All development projects must implement source control BMPs SC-1 through SC-6 where applicable and feasible. See Chapter 4 and Appendix E of the Manual for information to implement source control BMPs shown in this checklist.			
Answer each category below pursuant to the following.			
<ul style="list-style-type: none"> • "Yes" means the project will implement the source control BMP as described in Chapter 4 and/or Appendix E of the Manual. Discussion/justification is not required. • "No" means the BMP is applicable to the project but it is not feasible to implement. Discussion/justification must be provided. • "N/A" means the BMP is not applicable at the project site because the project does not include the feature that is addressed by the BMP (e.g., the project has no outdoor materials storage areas). Discussion/justification may be provided. 			
Source Control Requirement	Applied?		
SC-1 Prevention of Illicit Discharges into the MS4 (Authority BMPs SC01, SC04, SC05, SC09, SC11, SC12, SC13, SC14, SC15, and SC18 as applicable)	<input type="checkbox"/> Yes	<input type="checkbox"/> No	<input type="checkbox"/> N/A
Discussion/justification if SC-1 not implemented:			
SC-2 Storm Drain Stenciling or Signage (Authority BMP SC17)	<input type="checkbox"/> Yes	<input type="checkbox"/> No	<input type="checkbox"/> N/A
Discussion/justification if SC-2 not implemented:			
SC-3 Protect Outdoor Materials Storage Areas from Rainfall, Run-On, Runoff, and Wind Dispersal (Authority BMP SC07)	<input type="checkbox"/> Yes	<input type="checkbox"/> No	<input type="checkbox"/> N/A
Discussion/justification if SC-3 not implemented:			

Appendix A: Airport Authority Data and SWQMP Templates

Form H-4 Page 2 of 2			
Source Control Requirement	Applied?		
SC-4 Protect Materials Stored in Outdoor Work Areas from Rainfall, Run-On, Runoff, and Wind Dispersal (Authority BMPs SC02A, SC02B, SC02C, SC03, SC06, SC09, and SC21 as applicable)	<input type="checkbox"/> Yes	<input type="checkbox"/> No	<input type="checkbox"/> N/A
Discussion/justification if SC-4 not implemented:			
SC-5 Protect Trash Storage Areas from Rainfall, Run-On, Runoff, and Wind Dispersal (Authority BMP SC08)	<input type="checkbox"/> Yes	<input type="checkbox"/> No	<input type="checkbox"/> N/A
Discussion/justification if SC-5 not implemented:			
SC-6 Additional BMPs Based on Potential Sources of Runoff Pollutants (must answer for each source listed below)			
<input type="checkbox"/> Onsite storm drain inlets	<input type="checkbox"/> Yes	<input type="checkbox"/> No	<input type="checkbox"/> N/A
<input type="checkbox"/> Interior floor drains and elevator shaft sump pumps	<input type="checkbox"/> Yes	<input type="checkbox"/> No	<input type="checkbox"/> N/A
<input type="checkbox"/> Interior parking garages	<input type="checkbox"/> Yes	<input type="checkbox"/> No	<input type="checkbox"/> N/A
<input type="checkbox"/> Need for future indoor & structural pest control	<input type="checkbox"/> Yes	<input type="checkbox"/> No	<input type="checkbox"/> N/A
<input type="checkbox"/> Landscape/outdoor pesticide use	<input type="checkbox"/> Yes	<input type="checkbox"/> No	<input type="checkbox"/> N/A
<input type="checkbox"/> Pools, spas, ponds, decorative fountains, and other water features	<input type="checkbox"/> Yes	<input type="checkbox"/> No	<input type="checkbox"/> N/A
<input type="checkbox"/> Food service	<input type="checkbox"/> Yes	<input type="checkbox"/> No	<input type="checkbox"/> N/A
<input type="checkbox"/> Refuse areas	<input type="checkbox"/> Yes	<input type="checkbox"/> No	<input type="checkbox"/> N/A
<input type="checkbox"/> Industrial processes	<input type="checkbox"/> Yes	<input type="checkbox"/> No	<input type="checkbox"/> N/A
<input type="checkbox"/> Outdoor storage of equipment or materials	<input type="checkbox"/> Yes	<input type="checkbox"/> No	<input type="checkbox"/> N/A
<input type="checkbox"/> Vehicle and equipment cleaning	<input type="checkbox"/> Yes	<input type="checkbox"/> No	<input type="checkbox"/> N/A
<input type="checkbox"/> Vehicle/equipment repair and maintenance	<input type="checkbox"/> Yes	<input type="checkbox"/> No	<input type="checkbox"/> N/A
<input type="checkbox"/> Fuel dispensing areas	<input type="checkbox"/> Yes	<input type="checkbox"/> No	<input type="checkbox"/> N/A
<input type="checkbox"/> Loading docks	<input type="checkbox"/> Yes	<input type="checkbox"/> No	<input type="checkbox"/> N/A
<input type="checkbox"/> Fire sprinkler test water	<input type="checkbox"/> Yes	<input type="checkbox"/> No	<input type="checkbox"/> N/A
<input type="checkbox"/> Miscellaneous drain or wash water	<input type="checkbox"/> Yes	<input type="checkbox"/> No	<input type="checkbox"/> N/A
<input type="checkbox"/> Plazas, sidewalks, parking lots, ramps, taxiways, and runways	<input type="checkbox"/> Yes	<input type="checkbox"/> No	<input type="checkbox"/> N/A
Discussion/justification if SC-6 not implemented. Clearly identify which sources of runoff pollutants are discussed. Clarify which additional source control BMPs from Appendix B of the Authority SWMP will be implemented. Justification must be provided for <u>all</u> "No" answers shown above.			

Appendix A: Airport Authority Data and SWQMP Templates

Form H-5 Site Design BMP Checklist for All Development Projects (Standard Projects and PDPs)			
Project Identification			
Project Name			
Permit Application Number			
Site Design BMPs			
All development projects must implement site design BMPs SD-1 through SD-8 where applicable and feasible. See Chapter 4 and Appendix E of the Manual for information to implement site design BMPs shown in this checklist.			
Answer each category below pursuant to the following.			
<ul style="list-style-type: none"> • "Yes" means the project will implement the site design BMP as described in Chapter 4 and/or Appendix E of the Manual. Discussion/justification is not required. • "No" means the BMP is applicable to the project but it is not feasible to implement. Discussion/justification must be provided. • "N/A" means the BMP is not applicable at the project site because the project does not include the feature that is addressed by the BMP (e.g., the project site has no existing natural areas to conserve). Discussion/justification may be provided. 			
Site Design Requirement	Applied?		
SD-1 Maintain Natural Drainage Pathways and Hydrologic Features	<input type="checkbox"/> Yes	<input type="checkbox"/> No	<input type="checkbox"/> N/A
Discussion/justification if SD-1 not implemented:			
SD-2 Conserve Natural Areas, Soils, and Vegetation	<input type="checkbox"/> Yes	<input type="checkbox"/> No	<input type="checkbox"/> N/A
Discussion/justification if SD-2 not implemented:			
SD-3 Minimize Impervious Area	<input type="checkbox"/> Yes	<input type="checkbox"/> No	<input type="checkbox"/> N/A
Discussion/justification if SD-3 not implemented:			
SD-4 Minimize Soil Compaction	<input type="checkbox"/> Yes	<input type="checkbox"/> No	<input type="checkbox"/> N/A
Discussion/justification if SD-4 not implemented:			

Appendix A: Airport Authority Data and SWQMP Templates

Form H-5 Page 2 of 2			
Site Design Requirement	Applied?		
SD-5 Impervious Area Dispersion	<input type="checkbox"/> Yes	<input type="checkbox"/> No	<input type="checkbox"/> N/A
Discussion/justification if SD-5 not implemented:			
SD-6 Runoff Collection	<input type="checkbox"/> Yes	<input type="checkbox"/> No	<input type="checkbox"/> N/A
Discussion/justification if SD-6 not implemented:			
SD-7 Landscaping with Native or Drought Tolerant Species	<input type="checkbox"/> Yes	<input type="checkbox"/> No	<input type="checkbox"/> N/A
Discussion/justification if SD-7 not implemented:			
SD-8 Harvesting and Using Precipitation	<input type="checkbox"/> Yes	<input type="checkbox"/> No	<input type="checkbox"/> N/A
Discussion/justification if SD-8 not implemented:			

Appendix A: Airport Authority Data and SWQMP Templates

**ATTACHMENT 1
Copy of Plan Sheets Showing Permanent Storm Water BMPs**

This is the cover sheet for Attachment 1.

Use this checklist to ensure the required information has been included on the plans:

The plans must identify:

- Show all applicable permanent site design and source control BMPs as noted in Forms I-4 and I-5

A.4 PDP SWQMP Template

The following template is provided for use by a PDP SWQMP applicant or reviewer. It is not intended to replace a thorough review of the Manual and all appendices.

Appendix A: Airport Authority Data and SWQMP Templates

<p>SAN DIEGO COUNTY REGIONAL AIRPORT AUTHORITY</p> <p>PRIORITY DEVELOPMENT PROJECT (PDP)</p> <p>STORM WATER QUALITY MANAGEMENT PLAN (SWQMP)</p> <p>FOR</p> <p>[INSERT PROJECT NAME]</p> <p>[INSERT PERMIT APPLICATION NUMBERS]</p> <p>[INSERT PROJECT ADDRESS]</p> <p>[INSERT PROJECT CITY, STATE ZIP CODE]</p> <p>ASSESSOR'S PARCEL NUMBER(S):</p> <p>[INSERT APN(S)]</p>
<p>ENGINEER OF WORK:</p>
<p>_____</p> <p>[INSERT CIVIL ENGINEER'S NAME AND PE NUMBER HERE, PROVIDE WET SIGNATURE AND STAMP ABOVE LINE]</p>

PREPARED FOR:

[INSERT APPLICANT NAME]
[INSERT ADDRESS]
[INSERT CITY, STATE ZIP CODE]
[INSERT TELEPHONE NUMBER]

PDP SWQMP PREPARED BY:

[INSERT COMPANY NAME]
[INSERT ADDRESS]
[INSERT CITY, STATE ZIP CODE]
[INSERT TELEPHONE NUMBER]

DATE OF SWQMP:
[INSERT MONTH, DAY, YEAR]

PLANS PREPARED BY:
[INSERT CIVIL ENGINEER OR ARCHITECT]
[INSERT ADDRESS]
[INSERT CITY, STATE ZIP CODE]
[INSERT TELEPHONE NUMBER]

TABLE OF CONTENTS

Acronym Sheet
PDP SWQMP Preparer's Certification Page
PDP SWQMP Project Owner's Certification Page
Submittal Record
Project Vicinity Map
FORM H-1 Applicability of Permanent, Post-Construction Storm Water BMP Requirements
FORM H-2 Project Type Determination Checklist (Standard Project or PDP)
FORM H-3B Site Information Checklist for PDPs
FORM H-4 Source Control BMP Checklist for All Development Projects
FORM H-5 Site Design BMP Checklist for All Development Projects
FORM H-6 Summary of PDP Structural BMPs
Attachment 1: Backup for PDP Pollutant Control BMPs
 Attachment 1a: DMA Exhibit
 Attachment 1b: Tabular Summary of DMAs and Design Capture Volume Calculations
 Attachment 1c: Harvest and Use Feasibility Screening (when applicable)
 Attachment 1d: Categorization of Infiltration Feasibility Condition (when applicable)
 Attachment 1e: Pollutant Control BMP Design Worksheets/Calculations
Attachment 2: Structural BMP Maintenance Plan
 Attachment 3a: B Structural BMP Maintenance Thresholds and Actions
 Attachment 3b: Tenant Condition of Approval (when applicable)
Attachment 3: Copy of Plan Sheets Showing Permanent Storm Water BMPs

Appendix A: Airport Authority Data and SWQMP Templates

ACRONYMS

APN	Assessor's Parcel Number
BMP	Best Management Practice
HMP	Hydromodification Management Plan
HSG	Hydrologic Soil Group
MS4	Municipal Separate Storm Sewer System
N/A	Not Applicable
NRCS	Natural Resources Conservation Service
PDP	Priority Development Project
PE	Professional Engineer
SC	Source Control
SD	Site Design
SDRWQCB	San Diego Regional Water Quality Control Board
SIC	Standard Industrial Classification
SWQMP	Storm Water Quality Management Plan

PDP SWQMP PREPARER'S CERTIFICATION PAGE

Project Name: [Insert Project Name]

Permit Application Number: [Insert Permit Application Number]

PREPARER'S CERTIFICATION

I hereby declare that I am the Engineer in Responsible Charge of design of storm water best management practices (BMPs) for this project, and that I have exercised responsible charge over the design of the BMPs as defined in Section 6703 of the Business and Professions Code, and that the design is consistent with the PDP requirements of the [INSERT AGENCY NAME] BMP Design Manual, which is a design manual for compliance with local [INSERT AGENCY NAME] and regional MS4 Permit (California Regional Water Quality Control Board San Diego Region Order No. R9-2015-0100) requirements for storm water management.

I have read and understand that the San Diego County Regional Airport Authority has adopted minimum requirements for managing urban runoff, including storm water, from land development activities, as described in the BMP Design Manual. I certify that this PDP SWQMP has been completed to the best of my ability and accurately reflects the project being proposed and the applicable BMPs proposed to minimize the potentially negative impacts of this project's land development activities on water quality. I understand and acknowledge that the plan check review of this PDP SWQMP by the San Diego County Airport Authority Environmental Affairs Department and/or Facilities Development Department is confined to a review and does not relieve me, as the Engineer in Responsible Charge of design of storm water BMPs for this project, of my responsibilities for project design.

Engineer of Work's Signature, PE Number & Expiration Date

Print Name

Company

Date

Engineer's Seal:

PDP SWQMP PROJECT OWNER'S CERTIFICATION PAGE

Project Name: [Insert Project Name]

Permit Application Number: [Insert Permit Application Number]

PROJECT OWNER'S CERTIFICATION

This PDP SWQMP has been prepared for [INSERT PROJECT OWNER'S COMPANY NAME] by [INSERT SWQMP PREPARER'S COMPANY NAME]. The PDP SWQMP is intended to comply with the PDP requirements of the San Diego County Regional Airport Authority BMP Design Manual, which is a design manual for compliance with local San Diego County Regional Airport Authority and regional MS4 Permit (California Regional Water Quality Control Board San Diego Region Order No. R9-2015-0100) requirements for storm water management.

The undersigned, while it owns the subject property, is responsible for the implementation of the provisions of this plan. Once the undersigned transfers its interests in the property, its successor-in-interest shall bear the aforementioned responsibility to implement the best management practices (BMPs) described within this plan, including ensuring on-going operation and maintenance of structural BMPs. A signed copy of this document shall be available on the subject property into perpetuity.

Project Owner's Signature

Print Name

Company

Date

Appendix A: Airport Authority Data and SWQMP Templates

SUBMITTAL RECORD

Use this Table to keep a record of submittals of this PDP SWQMP. Each time the PDP SWQMP is re-submitted, provide the date and status of the project. In column 4 summarize the changes that have been made or indicate if response to plan check comments is included. When applicable, insert response to plan check comments behind this page.

Submittal Number	Date	Project Status	Summary of Changes
1		<input type="checkbox"/> Preliminary Design/Planning/CEQA <input type="checkbox"/> Final Design	Initial Submittal
2		<input type="checkbox"/> Preliminary Design/Planning/CEQA <input type="checkbox"/> Final Design	
3		<input type="checkbox"/> Preliminary Design/Planning/CEQA <input type="checkbox"/> Final Design	
4		<input type="checkbox"/> Preliminary Design/Planning/CEQA <input type="checkbox"/> Final Design	

Appendix A: Airport Authority Data and SWQMP Templates

PROJECT VICINITY MAP

Project Name: [Insert Project Name]

Permit Application Number: [Insert Permit Application Number]

[Insert Project Vicinity Map here]

Appendix A: Airport Authority Data and SWQMP Templates

Applicability of Permanent, Post-Construction Storm Water BMP Requirements (Storm Water Intake Form for all Development Permit Applications)		Form H-1
Project Identification		
Project Name:		
Permit Application Number:		Date:
Determination of Requirements		
<p>The purpose of this form is to identify permanent, post-construction requirements that apply to the project. This form serves as a short <u>summary</u> of applicable requirements, in some cases referencing separate forms that will serve as the backup for the determination of requirements.</p> <p>Answer each step below, starting with Step 1 and progressing through each step until reaching "Stop". Refer to the Manual sections and/or separate forms referenced in each step below.</p>		
Step	Answer	Progression
Step 1: Is the project a "development project"? See Section 1.3 of the Manual for guidance.	<input type="checkbox"/> Yes	Go to Step 2.
	<input type="checkbox"/> No	Stop. Permanent BMP requirements do not apply. No SWQMP will be required. Provide discussion below.
Discussion/justification if the project is <u>not</u> a "development project" (e.g., the project includes <i>only</i> interior remodels within an existing building):		
Step 2: Is the project a Standard Project, PDP, or exception to PDP definitions? To answer this item, see Section 1.4 of the Manual <i>in its entirety</i> for guidance, AND complete Form H-2, Project Type Determination.	<input type="checkbox"/> Standard Project	Stop. Standard Project requirements apply, including Standard Project SWQMP.
	<input type="checkbox"/> PDP	PDP requirements apply, including PDP SWQMP. Go to Step 3.
	<input type="checkbox"/> Exception to PDP definitions	Stop. Standard Project requirements apply. Provide discussion and list any additional requirements below. Prepare Standard Project SWQMP.
Discussion/justification, and additional requirements for exceptions to PDP definitions, if applicable:		

Appendix A: Airport Authority Data and SWQMP Templates

Form H-1 Page 2 of 2		
Step	Answer	Progression
Step 3. Do hydromodification control requirements apply? See Section 1.6 of the Manual for guidance. <u>Note: Hydromodification control requirements do not apply to projects within Airport Authority jurisdiction that drain through concrete lined channels or conveyances that discharge directly to San Diego Bay.</u>	<input type="checkbox"/> Yes	PDP structural BMPs required for pollutant control (Chapter 5) and hydromodification control (Chapter 6). Go to Step 4.
	<input type="checkbox"/> No	Stop. PDP structural BMPs required for pollutant control (Chapter 5) only. Provide brief discussion of exemption to hydromodification control below.
Discussion/justification if hydromodification control requirements do <u>not</u> apply:		
Step 4. Does protection of critical coarse sediment yield areas apply? See Section 6.2 of the Manual for guidance. <u>Note: Critical coarse sediment yield areas are not present within Airport Authority jurisdiction. See Section 1.6 and Appendix A of the Manual.</u>	<input type="checkbox"/> Yes	Management measures required for protection of critical coarse sediment yield areas (Chapter 6.2). Stop.
	<input type="checkbox"/> No	Management measures not required for protection of critical coarse sediment yield areas. Provide brief discussion below. Stop.
Discussion/justification if protection of critical coarse sediment yield areas does <u>not</u> apply:		

Appendix A: Airport Authority Data and SWQMP Templates

Project Type Determination Checklist		Form H-2	
Project Information			
Project Name:			
Permit Application Number:			
Project Type Determination: Standard Project or PDP			
The project is (select one): <input type="checkbox"/> New Development <input type="checkbox"/> Redevelopment			
The total proposed newly created or replaced impervious area is: _____ ft ² (_____) acres			
Is the project in any of the following categories, (a) through (f)?			
Yes <input type="checkbox"/>	No <input type="checkbox"/>	(a)	New development projects that create 10,000 square feet or more of impervious surfaces (collectively over the entire project site). This includes commercial, industrial, mixed-use, and public development projects on public or private land.
Yes <input type="checkbox"/>	No <input type="checkbox"/>	(b)	Redevelopment projects that create and/or replace 5,000 square feet or more of impervious surface (collectively over the entire project site on an existing site of 10,000 square feet or more of impervious surfaces). This includes commercial, industrial, mixed-use, and public development projects on public or private land.
Yes <input type="checkbox"/>	No <input type="checkbox"/>	(c)	<p>New and redevelopment projects that create and/or replace 5,000 square feet or more of impervious surface (collectively over the entire project site), and support one or more of the following uses:</p> <ul style="list-style-type: none"> (i) Restaurants. This category is defined as a facility that sells prepared foods and drinks for consumption, including stationary lunch counters and refreshment stands selling prepared foods and drinks for immediate consumption SIC code 5812). (ii) Parking lots. This category is defined as a land area or facility for the temporary parking or storage of motor vehicles used personally, for business, or for commerce. (iii) Streets, roads, highways, freeways, and driveways. This category is defined as any paved impervious surface used for the transportation of automobiles, trucks, motorcycles, and other vehicles.

Appendix A: Airport Authority Data and SWQMP Templates

Form H-2 Page 2 of 2			
Yes <input type="checkbox"/>	No <input type="checkbox"/>	(d)	<p>New or redevelopment projects that create and/or replace 2,500 square feet or more of impervious surface (collectively over the entire project site) and discharging directly to an Environmentally Sensitive Area (ESA). “Discharging directly to” includes flow that is conveyed overland a distance of 200 feet or less from the project to the ESA or conveyed in a pipe or open channel any distance as an isolated flow from the project to the ESA (i.e., not commingled with flows from adjacent lands).</p> <p><u>Note: ESAs are areas that include but are not limited to all Clean Water Act Section 303(d) impaired water bodies; areas designated as Areas of Special Biological Significance by the State Water Board and SDRWQCB; State Water Quality Protected Areas; water bodies designated with the RARE beneficial use by the State Water Board and SDRWQCB; and any other equivalent environmentally sensitive areas which have been identified by the Copermittees. See Manual Section 1.4.2 for additional guidance and Appendix A.</u></p>
Yes <input type="checkbox"/>	No <input type="checkbox"/>	(e)	<p>New development projects, or redevelopment project that create and/or replace 5,000 ft² or more of impervious surface, that support one or more of the following uses:</p> <p>(i) Automotive repair shops. This category is defined as a facility that is categorized in any one of the following SIC codes: 5013, 5014, 5541, 7532-7534, or 7536-7539.</p> <p>(ii) Retail gasoline outlets. This category includes retail gasoline outlets that meet the following criteria: (a) 5,000 square feet or more or (b) a projected Average Daily Traffic of 100 or more vehicles per day.</p>
Yes <input type="checkbox"/>	No <input type="checkbox"/>	(f)	<p>New or redevelopment projects that result in the disturbance of one or more acres of land and are expected to generate pollutants post construction.</p> <p><i>Note: See Manual Section 1.4.2 for additional guidance.</i></p>
<p>Does the project meet the definition of one or more of the PDP categories (a) through (f) listed above?</p> <p><input type="checkbox"/> No – the project is not a PDP (Standard Project).</p> <p><input type="checkbox"/> Yes – the project is a PDP.</p>			
<p>The following is for redevelopment PDPs only:</p> <p>The area of existing (pre-project) impervious area at the project site is: _____ ft² (A)</p> <p>The total proposed newly created or replaced impervious area is: _____ ft² (B)</p> <p>Percent impervious surface created or replaced (B/A)*100: _____%</p> <p>The percent impervious surface created or replaced is (select one based on the above calculation):</p> <p><input type="checkbox"/> less than or equal to fifty percent (50%) – only new impervious areas are considered PDP</p> <p>OR</p> <p><input type="checkbox"/> greater than fifty percent (50%) – the entire project site is a PDP</p>			
<p>Site Information Checklist For PDPs</p>			<p>Form H-3B (PDPs)</p>
Project Summary Information			
Project Name			

Appendix A: Airport Authority Data and SWQMP Templates

Project Address	
Assessor's Parcel Number(s)	
Permit Application Number	
Project Watershed (Hydrologic Unit)	Select One: <input type="checkbox"/> Pueblo San Diego 908
Parcel Area (Total area of Assessor's Parcel(s) associated with the project)	_____ Acres (_____ Square Feet)
Area to be disturbed by the project (Project Area)	_____ Acres (_____ Square Feet)
Project Proposed Impervious Area (Subset of Project Area)	_____ Acres (_____ Square Feet)
Project Proposed Pervious Area (Subset of Project Area)	_____ Acres (_____ Square Feet)
Note: Proposed Impervious Area + Proposed Pervious Area = Area to be Disturbed by the Project. This may be less than the Parcel Area.	

Appendix A: Airport Authority Data and SWQMP Templates

Form H-3B Page 2 of 7	
Description of Existing Site Condition and Drainage Patterns	
<p>Current Status of the Site (select all that apply):</p> <ul style="list-style-type: none"> <input type="checkbox"/> Existing development <input type="checkbox"/> Previously graded but not built out <input type="checkbox"/> Agricultural or other non-impervious use <input type="checkbox"/> Vacant, undeveloped/natural <p>Description/Additional Information:</p>	
<p>Existing Land Cover Includes (select all that apply):</p> <ul style="list-style-type: none"> <input type="checkbox"/> Vegetative Cover <input type="checkbox"/> Non-Vegetated Pervious Areas <input type="checkbox"/> Impervious Areas <p>Description/Additional Information:</p>	
<p>Underlying Soil belongs to Hydrologic Soil Group (select all that apply):</p> <ul style="list-style-type: none"> <input type="checkbox"/> NRCS Type A <input type="checkbox"/> NRCS Type B <input type="checkbox"/> NRCS Type C <input type="checkbox"/> NRCS Type D 	
<p>Approximate Depth to Groundwater:</p> <ul style="list-style-type: none"> <input type="checkbox"/> Groundwater Depth < 5 feet <input type="checkbox"/> 5 feet < Groundwater Depth < 10 feet <input type="checkbox"/> 10 feet < Groundwater Depth < 20 feet <input type="checkbox"/> Groundwater Depth > 20 feet 	
<p>Existing Natural Hydrologic Features (select all that apply):</p> <ul style="list-style-type: none"> <input type="checkbox"/> Watercourses <input type="checkbox"/> Seeps <input type="checkbox"/> Springs <input type="checkbox"/> Wetlands <input type="checkbox"/> None <p>Description/Additional Information:</p>	

Appendix A: Airport Authority Data and SWQMP Templates

Form H-3B Page 3 of 7

Description of Existing Site Topography and Drainage [How is storm water runoff conveyed from the site? At a minimum, this description should answer (1) whether existing drainage conveyance is natural or urban; (2) describe existing constructed storm water conveyance systems, if applicable; and (3) is runoff from offsite conveyed through the site? If so, describe]:

Appendix A: Airport Authority Data and SWQMP Templates

Form H-3B Page 4 of 7	
Description of Proposed Site Development and Drainage Patterns	
Project Description/Proposed Land Use and/or Activities:	
List/describe proposed impervious features of the project (e.g., buildings, roadways, parking lots, courtyards, athletic courts, other impervious features):	
List/describe proposed pervious features of the project (e.g., landscape areas):	
Does the project include grading and changes to site topography? <input type="checkbox"/> Yes <input type="checkbox"/> No Description/Additional Information:	
Does the project include changes to site drainage (e.g., installation of new storm water conveyance systems)? <input type="checkbox"/> Yes <input type="checkbox"/> No Description/Additional Information:	

Appendix A: Airport Authority Data and SWQMP Templates

Form H-3B Page 5 of 7

Identify whether any of the following features, activities, and/or pollutant source areas will be present (select all that apply):

- Onsite storm drain inlets
- Interior floor drains and elevator shaft sump pumps
- Interior parking garages
- Need for future indoor & structural pest control
- Landscape/outdoor pesticide use
- Pools, spas, ponds, decorative fountains, and other water features
- Food service
- Refuse areas
- Industrial processes
- Outdoor storage of equipment or materials
- Vehicle and equipment cleaning
- Vehicle/equipment repair and maintenance
- Fuel dispensing areas
- Loading docks
- Fire sprinkler test water
- Miscellaneous drain or wash water
- Plazas, sidewalks, parking lots, ramp, taxiway, and runway

Appendix A: Airport Authority Data and SWQMP Templates

Form H-3B Page 6 of 7			
Identification of Receiving Water Pollutants of Concern			
Describe path of storm water from the project site to the Pacific Ocean (or bay, lagoon, lake or reservoir, as applicable):			
List any 303(d) impaired water bodies within the path of storm water from the project site to the Pacific Ocean (or bay, lagoon, lake or reservoir, as applicable), identify the pollutant(s)/stressor(s) causing impairment, and identify any TMDLs for the impaired water bodies:			
303(d) Impaired Water Body	Pollutant(s)/Stressor(s)	TMDLs	
Identification of Project Site Pollutants*			
*Identification of project site pollutants is only required if flow-through treatment BMPs are implemented onsite in lieu of retention or biofiltration BMPs (note the project must also participate in an alternative compliance program)			
Identify pollutants anticipated from the project site based on all proposed use(s) of the site (see Manual Appendix B.6):			
Pollutant	Not Applicable to the Project Site	Anticipated from the Project Site	Also a Receiving Water Pollutant of Concern
Sediment			
Nutrients			
Heavy Metals			
Organic Compounds			
Trash & Debris			
Oxygen Demanding Substances			
Oil & Grease			
Bacteria & Viruses			
Pesticides			

Appendix A: Airport Authority Data and SWQMP Templates

Form H-3B Page 7 of 7

Hydromodification Management Requirements

Do hydromodification management requirements apply (see Section 1.6 of the Manual)?

- Yes, hydromodification management flow control structural BMPs required.
- No, the project will discharge runoff directly to existing underground storm drains discharging directly to water storage reservoirs, lakes, enclosed embayments, or the Pacific Ocean.
- No, the project will discharge runoff directly to conveyance channels whose bed and bank are concrete-lined all the way from the point of discharge to water storage reservoirs, lakes, enclosed embayments, or the Pacific Ocean.
- No, the project will discharge runoff directly to an area identified as appropriate for an exemption by the WMAA for the watershed in which the project resides.

Description/Additional Information (to be provided if a 'No' answer has been selected above):

Other Site Requirements and Constraints

When applicable, list other site requirements or constraints that will influence storm water management design, such as zoning requirements including setbacks and open space, or local codes governing minimum street width, sidewalk construction, allowable pavement types, and drainage requirements.

Optional Additional Information or Continuation of Previous Sections as Needed

This space provided for additional information or continuation of information from previous sections as needed.

Appendix A: Airport Authority Data and SWQMP Templates

Source Control BMP Checklist for All Development Projects (Standard Projects and PDPs)		Form H-4	
Project Identification			
Project Name			
Permit Application Number			
Source Control BMPs			
All development projects must implement source control BMPs SC-1 through SC-6 where applicable and feasible. See Chapter 4 and Appendix E of the Manual for information to implement source control BMPs shown in this checklist.			
Answer each category below pursuant to the following.			
<ul style="list-style-type: none"> • "Yes" means the project will implement the source control BMP as described in Chapter 4 and/or Appendix E of the Manual. Discussion/justification is not required. • "No" means the BMP is applicable to the project but it is not feasible to implement. Discussion/justification must be provided. • "N/A" means the BMP is not applicable at the project site because the project does not include the feature that is addressed by the BMP (e.g., the project has no outdoor materials storage areas). Discussion/justification may be provided. 			
Source Control Requirement	Applied?		
SC-1 Prevention of Illicit Discharges into the MS4 (Authority BMPs SC01, SC04, SC05, SC09, SC11, SC12, SC13, SC14, SC15, and SC18 as applicable)	<input type="checkbox"/> Yes	<input type="checkbox"/> No	<input type="checkbox"/> N/A
Discussion/justification if SC-1 not implemented:			
SC-2 Storm Drain Stenciling or Signage (Authority BMP SC17)	<input type="checkbox"/> Yes	<input type="checkbox"/> No	<input type="checkbox"/> N/A
Discussion/justification if SC-2 not implemented:			
SC-3 Protect Outdoor Materials Storage Areas from Rainfall, Run-On, Runoff, and Wind Dispersal (Authority BMP SC07)	<input type="checkbox"/> Yes	<input type="checkbox"/> No	<input type="checkbox"/> N/A
Discussion/justification if SC-3 not implemented:			

Appendix A: Airport Authority Data and SWQMP Templates

Form H-4 Page 2 of 2			
Source Control Requirement	Applied?		
SC-4 Protect Materials Stored in Outdoor Work Areas from Rainfall, Run-On, Runoff, and Wind Dispersal (Authority BMPs SC02A, SC02B, SC02C, SC03, SC06, SC09, and SC21 as applicable)	<input type="checkbox"/> Yes	<input type="checkbox"/> No	<input type="checkbox"/> N/A
Discussion/justification if SC-4 not implemented:			
SC-5 Protect Trash Storage Areas from Rainfall, Run-On, Runoff, and Wind Dispersal (Authority BMP SC08)	<input type="checkbox"/> Yes	<input type="checkbox"/> No	<input type="checkbox"/> N/A
Discussion/justification if SC-5 not implemented:			
SC-6 Additional BMPs Based on Potential Sources of Runoff Pollutants (must answer for each source listed below)			
<input type="checkbox"/> Onsite storm drain inlets	<input type="checkbox"/> Yes	<input type="checkbox"/> No	<input type="checkbox"/> N/A
<input type="checkbox"/> Interior floor drains and elevator shaft sump pumps	<input type="checkbox"/> Yes	<input type="checkbox"/> No	<input type="checkbox"/> N/A
<input type="checkbox"/> Interior parking garages	<input type="checkbox"/> Yes	<input type="checkbox"/> No	<input type="checkbox"/> N/A
<input type="checkbox"/> Need for future indoor & structural pest control	<input type="checkbox"/> Yes	<input type="checkbox"/> No	<input type="checkbox"/> N/A
<input type="checkbox"/> Landscape/outdoor pesticide use	<input type="checkbox"/> Yes	<input type="checkbox"/> No	<input type="checkbox"/> N/A
<input type="checkbox"/> Pools, spas, ponds, decorative fountains, and other water features	<input type="checkbox"/> Yes	<input type="checkbox"/> No	<input type="checkbox"/> N/A
<input type="checkbox"/> Food service	<input type="checkbox"/> Yes	<input type="checkbox"/> No	<input type="checkbox"/> N/A
<input type="checkbox"/> Refuse areas	<input type="checkbox"/> Yes	<input type="checkbox"/> No	<input type="checkbox"/> N/A
<input type="checkbox"/> Industrial processes	<input type="checkbox"/> Yes	<input type="checkbox"/> No	<input type="checkbox"/> N/A
<input type="checkbox"/> Outdoor storage of equipment or materials	<input type="checkbox"/> Yes	<input type="checkbox"/> No	<input type="checkbox"/> N/A
<input type="checkbox"/> Vehicle and equipment cleaning	<input type="checkbox"/> Yes	<input type="checkbox"/> No	<input type="checkbox"/> N/A
<input type="checkbox"/> Vehicle/equipment repair and maintenance	<input type="checkbox"/> Yes	<input type="checkbox"/> No	<input type="checkbox"/> N/A
<input type="checkbox"/> Fuel dispensing areas	<input type="checkbox"/> Yes	<input type="checkbox"/> No	<input type="checkbox"/> N/A
<input type="checkbox"/> Loading docks	<input type="checkbox"/> Yes	<input type="checkbox"/> No	<input type="checkbox"/> N/A
<input type="checkbox"/> Fire sprinkler test water	<input type="checkbox"/> Yes	<input type="checkbox"/> No	<input type="checkbox"/> N/A
<input type="checkbox"/> Miscellaneous drain or wash water	<input type="checkbox"/> Yes	<input type="checkbox"/> No	<input type="checkbox"/> N/A
<input type="checkbox"/> Plazas, sidewalks, parking lots, ramps, taxiways, and runways	<input type="checkbox"/> Yes	<input type="checkbox"/> No	<input type="checkbox"/> N/A
Discussion/justification if SC-6 not implemented. Clearly identify which sources of runoff pollutants are discussed. Clarify which additional source control BMPs from Appendix B of the Authority SWMP will be implemented. Justification must be provided for <u>all</u> "No" answers shown above.			

Appendix A: Airport Authority Data and SWQMP Templates

Site Design BMP Checklist for All Development Projects (Standard Projects and PDPs)		Form H-5	
Project Identification			
Project Name			
Permit Application Number			
Site Design BMPs			
All development projects must implement site design BMPs SD-1 through SD-8 where applicable and feasible. See Chapter 4 and Appendix E of the Manual for information to implement site design BMPs shown in this checklist.			
Answer each category below pursuant to the following.			
<ul style="list-style-type: none"> • "Yes" means the project will implement the site design BMP as described in Chapter 4 and/or Appendix E of the Manual. Discussion/justification is not required. • "No" means the BMP is applicable to the project but it is not feasible to implement. Discussion/justification must be provided. • "N/A" means the BMP is not applicable at the project site because the project does not include the feature that is addressed by the BMP (e.g., the project site has no existing natural areas to conserve). Discussion/justification may be provided. 			
Site Design Requirement		Applied?	
SD-1 Maintain Natural Drainage Pathways and Hydrologic Features	<input type="checkbox"/> Yes	<input type="checkbox"/> No	<input type="checkbox"/> N/A
Discussion/justification if SD-1 not implemented:			
SD-2 Conserve Natural Areas, Soils, and Vegetation	<input type="checkbox"/> Yes	<input type="checkbox"/> No	<input type="checkbox"/> N/A
Discussion/justification if SD-2 not implemented:			
SD-3 Minimize Impervious Area	<input type="checkbox"/> Yes	<input type="checkbox"/> No	<input type="checkbox"/> N/A
Discussion/justification if SD-3 not implemented:			
SD-4 Minimize Soil Compaction	<input type="checkbox"/> Yes	<input type="checkbox"/> No	<input type="checkbox"/> N/A
Discussion/justification if SD-4 not implemented:			

Appendix A: Airport Authority Data and SWQMP Templates

Form H-5 Page 2 of 2			
Site Design Requirement	Applied?		
SD-5 Impervious Area Dispersion	<input type="checkbox"/> Yes	<input type="checkbox"/> No	<input type="checkbox"/> N/A
Discussion/justification if SD-5 not implemented:			
SD-6 Runoff Collection	<input type="checkbox"/> Yes	<input type="checkbox"/> No	<input type="checkbox"/> N/A
Discussion/justification if SD-6 not implemented:			
SD-7 Landscaping with Native or Drought Tolerant Species	<input type="checkbox"/> Yes	<input type="checkbox"/> No	<input type="checkbox"/> N/A
Discussion/justification if SD-7 not implemented:			
SD-8 Harvesting and Using Precipitation	<input type="checkbox"/> Yes	<input type="checkbox"/> No	<input type="checkbox"/> N/A
Discussion/justification if SD-8 not implemented:			

Appendix A: Airport Authority Data and SWQMP Templates

Summary of PDP Structural BMPs	Form H-6 (PDPs)
Project Identification	
Project Name	
Permit Application Number	
PDP Structural BMPs	
<p>All PDPs must implement structural BMPs for storm water pollutant control (see Chapter 5 of the Manual). Selection of PDP structural BMPs for storm water pollutant control must be based on the selection process described in Chapter 5.</p> <p>PDP structural BMPs must be verified by the local jurisdiction at the completion of construction. This may include requiring the project owner or project owner's representative to certify construction of the structural BMPs (see Section 1.12 of the Manual). PDP structural BMPs must be maintained into perpetuity, and the local jurisdiction must confirm the maintenance (see Section 7 of the Manual).</p> <p>Use this form to provide narrative description of the general strategy for structural BMP implementation at the project site in the box below. Then complete the PDP structural BMP summary information sheet (page 3 of this form) for each structural BMP within the project (copy the BMP summary information page as many times as needed to provide summary information for each individual structural BMP).</p> <p>Describe the general strategy for structural BMP implementation at the site. This information must describe how the steps for selecting and designing storm water pollutant control BMPs presented in Section 5.1 of the Manual were followed, and the results (type of BMPs selected).</p>	
(Continue on page 2 as necessary.)	

Appendix A: Airport Authority Data and SWQMP Templates

Form H-6 Page 2 of 3

(Page reserved for continuation of description of general strategy for structural BMP implementation at the site)

(Continued from page 1)

Appendix A: Airport Authority Data and SWQMP Templates

Form H-6 Page 3 of 3 (Copy as many as needed)	
Structural BMP Summary Information	
(Copy this page as needed to provide information for each individual proposed structural BMP)	
Structural BMP ID No.	
Construction Plan Sheet No.	
Type of structural BMP: <input type="checkbox"/> Retention by harvest and use (HU-1) <input type="checkbox"/> Retention by infiltration basin (INF-1) <input type="checkbox"/> Retention by bioretention (INF-2) <input type="checkbox"/> Retention by permeable pavement (INF-3) <input type="checkbox"/> Partial retention by biofiltration with partial retention (PR-1) <input type="checkbox"/> Biofiltration (BF-1) <input type="checkbox"/> Flow-through treatment control included as pre-treatment/forebay for an onsite retention or biofiltration BMP (provide BMP type/description and indicate which onsite retention or biofiltration BMP it serves in discussion section below) <input type="checkbox"/> Flow-through treatment control with alternative compliance (provide BMP type/description in discussion section below) <input type="checkbox"/> Detention pond or vault for hydromodification management <input type="checkbox"/> Other (describe in discussion section below)	
Purpose: <input type="checkbox"/> Pollutant control only <input type="checkbox"/> Combined pollutant control and hydromodification control (if desired) <input type="checkbox"/> Pre-treatment/forebay for another structural BMP <input type="checkbox"/> Other (describe in discussion section below)	
Who will certify construction of this BMP? Provide name and contact information for the party responsible to sign BMP verification forms if required by the P&EAD (See Section 1.12 of the Manual)	
Who will be the final owner of this BMP?	
Who will maintain this BMP into perpetuity?	
What is the funding mechanism for maintenance?	
Discussion (as needed):	

Appendix A: Airport Authority Data and SWQMP Templates

**ATTACHMENT 1
BACKUP FOR PDP POLLUTANT CONTROL BMPS**

This is the cover sheet for Attachment 1.

Indicate which Items are Included behind this cover sheet:

Attachment Sequence	Contents	Checklist
Attachment 1a	DMA Exhibit (Required) See DMA Exhibit Checklist on the back of this Attachment cover sheet.	<input type="checkbox"/> Included
Attachment 1b	Tabular Summary of DMAs Showing DMA ID matching DMA Exhibit, DMA Area, and DMA Type (Required)* *Provide table in this Attachment OR on DMA Exhibit in Attachment 1a	<input type="checkbox"/> Included on DMA Exhibit in Attachment 1a <input type="checkbox"/> Included as Attachment 1b, separate from DMA Exhibit
Attachment 1c	Form H-7 (Appendix H of the Manual), Harvest and Use Feasibility Screening Checklist (Required unless the entire project will use infiltration BMPs) Refer to Appendix B.3-1 of the BMP Design Manual to complete Form H-7.	<input type="checkbox"/> Included <input type="checkbox"/> Not included because the entire project will use infiltration BMPs
Attachment 1d	Form H-8 (Appendix H of the Manual), Categorization of Infiltration Feasibility Condition (Required unless the project will use harvest and use BMPs) Refer to Appendices C and D of the BMP Design Manual to complete Form H-8.	<input type="checkbox"/> Included <input type="checkbox"/> Not included because the entire project will use harvest and use BMPs
Attachment 1e	Pollutant Control BMP Design Worksheets/Calculations (Required) Refer to Appendices B and E of the BMP Design Manual for structural pollutant control BMP design guidelines	<input type="checkbox"/> Included

Use this checklist to ensure the required information has been included on the DMA Exhibit:

Appendix A: Airport Authority Data and SWQMP Templates

The DMA Exhibit must identify:

- Underlying hydrologic soil group
- Approximate depth to groundwater
- Existing natural hydrologic features (watercourses, seeps, springs, wetlands)
- Critical coarse sediment yield areas to be protected
- Existing topography and impervious areas
- Existing and proposed site drainage network and connections to drainage offsite
- Proposed demolition
- Proposed grading
- Proposed impervious features
- Proposed design features and surface treatments used to minimize imperviousness
- Drainage management area (DMA) boundaries, DMA ID numbers, and DMA areas (square footage or acreage), and DMA type (i.e., drains to BMP, self-retaining, or self-mitigating)
- Potential pollutant source areas and corresponding required source controls (see Chapter 4, Appendix E.1, and Form H-3B)
- Structural BMPs (identify location, type of BMP, and size/detail)

Appendix A: Airport Authority Data and SWQMP Templates

ATTACHMENT 2
Structural BMP Maintenance Information

This is the cover sheet for Attachment 2.

Indicate which Items are Included behind this cover sheet:

Attachment Sequence	Contents	Checklist
Attachment 2a	Structural BMP Maintenance Thresholds and Actions (Required)	<input type="checkbox"/> Included See Structural BMP Maintenance Information Checklist on the back of this Attachment cover sheet.
Attachment 2b	Tenant Condition of Approval (when applicable)	<input type="checkbox"/> Included <input type="checkbox"/> Not Applicable

Appendix A: Airport Authority Data and SWQMP Templates

Use this checklist to ensure the required information has been included in the Structural BMP Maintenance Information Attachment:

Preliminary Design/Planning/CEQA level submittal:

Attachment 2a must identify:

- Typical maintenance indicators and actions for proposed structural BMP(s) based on Section 7.7 of the BMP Design Manual

Attachment 2b is not required for preliminary design/planning/CEQA level submittal.

Final Design level submittal:

Attachment 2a must identify:

- Specific maintenance indicators and actions for proposed structural BMP(s). This shall be based on Section 7.7 of the BMP Design Manual and enhanced to reflect actual proposed components of the structural BMP(s)
- How to access the structural BMP(s) to inspect and perform maintenance
- Features that are provided to facilitate inspection (e.g., observation ports, cleanouts, silt posts, or other features that allow the inspector to view necessary components of the structural BMP and compare to maintenance thresholds)
- Manufacturer and part number for proprietary parts of structural BMP(s) when applicable
- Maintenance thresholds specific to the structural BMP(s), with a location-specific frame of reference (e.g., level of accumulated materials that triggers removal of the materials, to be identified based on viewing marks on silt posts or measured with a survey rod with respect to a fixed benchmark within the BMP)
- Recommended equipment to perform maintenance
- When applicable, necessary special training or certification requirements for inspection and maintenance personnel such as confined space entry or hazardous waste management

Attachment 2b: For tenant projects, Attachment 2b shall include a tenant condition of approval. An example is provided below, but the PDP applicant should contact the P&EAD to obtain the current condition of approval.

Appendix A: Airport Authority Data and SWQMP Templates

Attachment 2b: Example Tenant Condition of Approval

The following statement can be added as a condition of approval for all tenant projects:

“The San Diego County Regional Airport Authority (Authority) and San Diego International Airport (SAN) is regulated under California Regional Water Quality Control Board Order No. R9-2013-0001, as amended by Order No. R9-2015-0001 and R9-2015-0100 (MS4 Permit), as adopted, amended, and/or modified.

The MS4 Permit prohibits any activities that could degrade storm water quality. Post-construction/operational use of this project site must comply with the MS4, and Authority direction related to permitted activities including the requirements found in the Authority’s Storm Water Management Plan (SWMP).

No discharges of any material or waste, including potable water, wash water, dust, soil, trash, and debris, may contaminate storm water or enter the storm water conveyance system. Any such material that inadvertently contaminates storm water or enters the storm water conveyance system as part of site operations must be removed immediately. All unauthorized discharges to the storm water conveyance system or San Diego Bay or the ocean must be reported immediately to the Environmental Affairs Department to address any regulatory permit requirements regarding spill notifications.

Best management practices (BMPs) must be implemented by the tenant to control the potential release of any materials or wastes being handled or stored onsite that could enter the storm water conveyance system because of wind or storm water runoff.

In addition, this project is subject to the Authority’s BMP Design Manual. As such, approval of the project by the Authority is necessarily conditioned upon submission by the project proponent of a project specific Storm Water Quality Management Plan (SWQMP) that meets Authority requirements. Project approval requires full implementation of all SWQMP structural and non-structural BMPs throughout the life of the project. The implementation and maintenance of the SWQMP BMPs constitute regulatory obligations for the lessee, and failure to comply with the MS4 Permit, the SWMP, or the Authority-approved SWQMP, including the specific BMPs contained therein, may be considered a default under the lease.”

ATTACHMENT 3
Copy of Plan Sheets Showing Permanent Storm Water BMPs

This is the cover sheet for Attachment 3.

Use this checklist to ensure the required information has been included on the plans:

The plans must identify:

- Structural BMP(s) with ID numbers matching Form H-6 Summary of PDP Structural BMPs
- The grading and drainage design shown on the plans must be consistent with the delineation of DMAs shown on the DMA exhibit
- Details and specifications for construction of structural BMP(s)
- Signage indicating the location and boundary of structural BMP(s) as required by the P&EAD
- How to access the structural BMP(s) to inspect and perform maintenance
- Features that are provided to facilitate inspection (e.g., observation ports, cleanouts, silt posts, or other features that allow the inspector to view necessary components of the structural BMP and compare to maintenance thresholds)
- Manufacturer and part number for proprietary parts of structural BMP(s) when applicable
- Maintenance thresholds specific to the structural BMP(s), with a location-specific frame of reference (e.g., level of accumulated materials that triggers removal of the materials, to be identified based on viewing marks on silt posts or measured with a survey rod with respect to a fixed benchmark within the BMP)
- Recommended equipment to perform maintenance
- When applicable, necessary special training or certification requirements for inspection and maintenance personnel such as confined space entry or hazardous waste management
- Include landscaping plan sheets showing vegetation requirements for vegetated structural BMP(s)
- All BMPs must be fully dimensioned on the plans
- When proprietary BMPs are used, site-specific cross section with outflow, inflow, and model number shall be provided. Photocopies of general brochures are not acceptable.

Appendix

B

AUTHORITY BMP DESIGN MANUAL

Storm Water Pollutant Control Hydrologic Calculations and Sizing Methods

February 2022

Appendix B Storm Water Pollutant Control Hydrologic Calculations and Sizing Methods

Table of Contents:

- B.1. DCV
- B.2. Adjustments to Account for Site Design BMPs
- B.3. Harvest and Use BMPs
- B.4. Infiltration BMPs
- B.5. Biofiltration BMPs
- B.6. Flow-Through Treatment Control BMPs (for use with Alternative Compliance)

B.1 DCV

DCV is defined as the volume of storm water runoff resulting from the 24-hour, 85th percentile storm event. The following hydrologic method shall be used to calculate the DCV:

$$DCV = C \times d \times A \times 43,560 \text{ sf/ac} \times 1/12 \text{ in/ft}$$
$$DCV = 3,630 \times C \times d \times A$$

where:

DCV = design capture volume in cubic feet (ft³)

C = Runoff factor (unitless); refer to Section B.1.1

d = 24-hour, 85th percentile storm event rainfall depth (inches); refer to Section B.1.3

A = Tributary area (acres) which includes the total area draining to the BMP, including any offsite or onsite areas that comingles with project runoff and drains to the BMP. Refer to Chapter 3, Section 3.3.3 of the Manual for additional guidance. For street redevelopment projects, consult Section 1.4.3.

Appendix B: Storm Water Pollutant Control Hydrologic Calculations and Sizing Methods

B.1.1 Runoff Factor

Estimate the area weighted runoff factor for the tributary area to the BMP using runoff factor (from Table B.1-1) and area of each surface type in the tributary area and the following equation:

$$C = \frac{\sum C_x A_x}{\sum A_x}$$

where:

C_x = Runoff factor for area X

A_x = Tributary area X (acres)

These runoff factors apply to areas receiving direct rainfall only. For conditions in which runoff is routed onto a surface from an adjacent surface, see Section B.2 for determining composite runoff factors for these areas.

Table B.1-1. Runoff Factors for Surfaces Draining to BMPs – Pollutant Control BMPs

Surface	Runoff Factor
Roofs ¹	0.90
Concrete or Asphalt ¹	0.90
Unit Pavers (grouted) ¹	0.90
Decomposed Granite	0.30
Cobbles or Crushed Aggregate	0.30
Amended, Mulched Soils or Landscape	0.10
Compacted Soil (e.g., unpaved parking)	0.30
Natural (A Soil)	0.10
Natural (B Soil)	0.14
Natural (C Soil)	0.23
Natural (D Soil)	0.30

Notes:

1. Surface is considered impervious and could benefit from use of Site Design BMPs and adjustment of the runoff factor per Section B.2.1.

B.1.2 Offline BMPs

Diversion flow rates for offline BMPs shall be sized to convey the maximum flow rate of runoff produced from a rainfall intensity of 0.2 inch of rainfall per hour for each hour of every storm event. The following hydrologic method shall be used to calculate the diversion flow rate for off-line BMPs:

$$Q = C \times i \times A$$

Appendix B: Storm Water Pollutant Control Hydrologic Calculations and Sizing Methods

where:

Q = Diversion flow rate in ft³ per second

C = Runoff factor, area weighted estimate using Table B.1-1

i = Rainfall intensity of 0.2 inch/hour

A = Tributary area (acres): the total area draining to the BMP, including any offsite or onsite areas with runoff that comingles with project runoff and drains to the BMP. Refer to Chapter 3, Section 3.3.3 of the Manual for additional guidance. For street redevelopment projects, consult Section 1.4.3.

The 24-hour, 85th percentile isopleth map is provided as Figure B.1-1. The rainfall depth to estimate the DCV shall be determined using Figure B.1-1; SAN is located within the 0.5-inch rainfall depth zone. The methodology used to develop this map is presented below:

B.1.2.1 Gauge Data and Calculation of 85th Percentile

The method for calculating the 85th percentile is to produce a list of values, order them from smallest to largest, and then pick the value that is 85 percent through the list. Only values that are capable of producing runoff are of interest for this purpose. Lacking a legislative definition of rainfall values capable of producing runoff, Flood Control staff in San Diego County (County) have observed that the point at which significant runoff begins is rather subjective and is affected by land use type and soil moisture. In highly urbanized areas, the soil has high impermeability, and runoff can begin with as little as 0.02 inch of rainfall. In rural areas, soil impermeability is significantly lower, and even 0.30 inch of rainfall on dry soil will frequently not produce significant runoff. For this reason, San Diego County has chosen to use the more objective method of including all non-zero 24-hour rainfall totals when calculating the 85th percentile. To produce a statistically significant number, only stations with 30 years or more of daily rainfall records are used.

B.1.2.2 Mapping the Gauge Data

A collection of 56 precipitation gauge points was developed with 85th percentile precipitation values based on multiple years of gauge data. A raster surface (grid of cells with values) was interpolated from that set of points. The surface initially did not cover the County's entire jurisdiction. A total of 13 dummy points were added. Most of those were just outside the County boundary to enable the software to generate a surface that covered the entire County. A handful of points were added to enforce a plausible surface. In particular, one point was added in the desert east of Julian to enforce a gradient from high precipitation in the mountains to low precipitation in the desert. Three points were added near the northern boundary of the County to adjust the surface to reflect the effect of elevation in areas lacking sufficient operating gauges.

Several methods of interpolation were considered. The method chosen is named by Environmental Systems Research Institute as the Natural Neighbor technique. This method produces a surface that is highly empirical, with the value of the surface being a product of the values of the data points nearest each cell. It does not produce peaks or valleys of surface based on larger area trends and is free of artifacts that occurred with other methods.

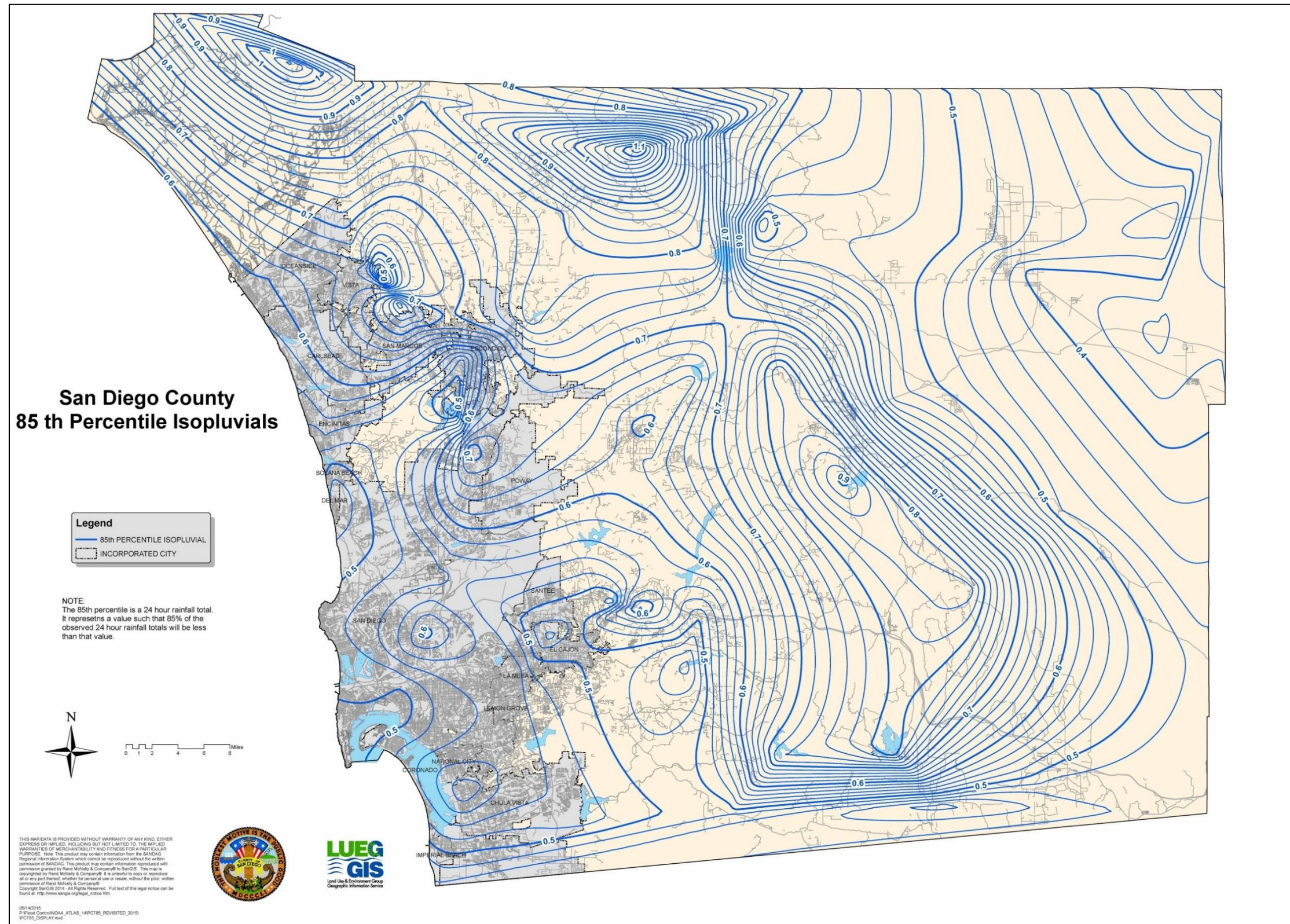

Figure B.1-1. 24-Hour, 85th Percentile Isopluvial Map

This page intentionally left blank

B.2 Adjustments to Account for Site Design BMPs

This section provides methods to adjust the design capture volume (DCV) (for sizing pollutant control BMPs) as a result of implementing site design BMPs. The adjustments are provided by one of the following two methods:

- Adjustment to impervious runoff factor
- Adjustment to the DCV

B.2.1 Adjustment to Impervious Runoff Factor

When one of the following site design BMPs is implemented, the runoff factor of 0.9 for impervious surfaces identified in Table B.1-1 should be adjusted using the factors listed below, and an adjusted area weighted runoff factor shall be estimated following guidance from Section B.1.1 and used to calculate the DCV:

- SD-B Impervious area dispersion
- SD-C Green roofs
- SD-D Permeable pavement

B.2.1.1 Impervious Area Dispersion (SD-B)

Dispersion of impervious areas through pervious areas: The following adjustments are allowed to impervious runoff factors when dispersion is implemented in accordance with the SD-B fact sheet (Appendix E). Adjustments are credited only up to a 4:1 maximum ratio of impervious to pervious areas. To adjust the runoff factor, the pervious area shall have a minimum width of 10 feet and a maximum slope of 5 percent (an exemption to this minimum width criterion is allowed when the contributing flow path length of the impervious area/pervious area width ≤ 2). Based on the ratio of **impervious area to pervious area** and the hydrologic soil group of the pervious area, the adjustment factor from Table B.2-1 shall be multiplied by the unadjusted runoff factor (Table B.1-1) of the impervious area to estimate the adjusted runoff factor for sizing pollutant control BMPs. The adjustment factors in Table B.2-1 are valid **only** for impervious surfaces that have an unadjusted runoff factor of 0.9.

Appendix B: Storm Water Pollutant Control Hydrologic Calculations and Sizing Methods

Table B.2-1. Impervious Area Adjustment Factors That Account for Dispersion

Pervious Area Hydrologic Soil Group	Ratio = Impervious Area/Pervious Area			
	<=1	2	3	4
A	0.00	0.00	0.23	0.36
B	0.00	0.27	0.42	0.53
C	0.34	0.56	0.67	0.74
D	0.86	0.93	0.97	1.00

Continuous simulation modeling in accordance with Appendix G is required to develop adjustment factors for surfaces that have an unadjusted runoff factor less than 0.9. Approval of adjustment factors for surfaces that have an unadjusted runoff factor less than 0.9 is at the discretion of ADC and P&EAD.

The adjustment factors in Table B.2-1 were developed by performing continuous simulations in the Storm Water Management Model (SWMM) with default parameters from Appendix G and impervious to pervious area ratios of 1, 2, 3, and 4. When using adjustment factors from Table B.2-1:

- **Linear interpolation** shall be performed if the impervious to pervious area ratio of the site is between one of ratios for which an adjustment factor was developed;
- An adjustment factor is used for a ratio of 1 when the impervious to pervious area ratio is less than 1; and
- An adjustment factor is not allowed when the impervious to pervious area ratio is greater than 4 when the pervious area is designed as a site design BMP.

Example B.2-1: The drainage management area (DMA) is composed of 1 acre of impervious area that drains to a 0.4-acre hydrologic soil group B pervious area, and then the pervious area drains to a BMP. Impervious area dispersion is implemented in the DMA in accordance with the SD-B fact sheet. Estimate the adjusted runoff factor for the DMA:

- Baseline runoff factor per Table B.1-1 = $[(1*0.9+0.4*0.14)/1.4] = 0.68$.
- Impervious to pervious ratio = 1 acre impervious area/0.4 acre pervious area = 2.5; because the ratio is 2.5, adjustment can be claimed.
- From Table B.2-1, the adjustment factor for hydrologic soil group B and a ratio of 2 = 0.27; ratio of 3 = 0.42.
- Linear interpolated adjustment factor for a ratio of 2.5 = $0.27 + \{[(0.42 - 0.27)/(3-2)]*(2.5-2)\} = 0.345$.
- Adjusted runoff factor for the DMA = $[(1*0.9*0.345+0.4*0.14)/1.4] = 0.26$.

Note: Only the runoff factor for impervious area is adjusted; there is no change made to the pervious area.

Appendix B: Storm Water Pollutant Control Hydrologic Calculations and Sizing Methods

B.2.1.2 Green Roofs

When green roofs are implemented in accordance with the SD-C fact sheet, the green roof footprint shall be assigned a runoff factor of 0.10 for adjusted runoff factor calculations.

B.2.1.3 Permeable Pavement

When permeable pavement is implemented in accordance with the SD-D fact sheet and it does not have an impermeable liner and has storage greater than the 85th percentile depth below the underdrain (if an underdrain is present), then the footprint of the permeable pavement shall be assigned a runoff factor of 0.10 for adjusted runoff factor calculations.

Permeable pavement can also be designed as a structural BMP to treat run-on from adjacent areas. Refer to the INF-3 fact sheet and Appendix E for additional guidance.

B.2.2 Adjustment to DCV

When the following site design BMPs are implemented, the anticipated volume reduction from these BMPs shall be deducted from the DCV to estimate the volume for which the downstream structural BMP should be sized:

- SD-A: Tree Wells
- SD-E Rain barrels

B.2.2.1 Tree Wells

Tree well credit volume from tree trenches or boxes (tree BMPs) is a sum of three runoff reduction volumes provided by trees that decrease the required DCV for a tributary area. The following reduction in DCV is allowed per tree based on the mature diameter of the tree canopy when trees are implemented in accordance with SD-A fact sheet and meet the following criteria:

- Total tree credit volume is less than 0.25 DCV of the project footprint and
- Single tree credit volume is less than 400 ft³

Credit for trees that do not meet these criteria shall be based on the criteria for sizing the tree as a storm water pollutant control BMP in the SD-A fact sheet.

Appendix B: Storm Water Pollutant Control Hydrologic Calculations and Sizing Methods

Mature Tree Canopy Diameter (feet)	Tree Credit Volume (ft ³ /tree)
5	10
10	40
15	100
20	180
25	290
30	400

Basis for the reduction in DCV:

Estimation of tree credit volume was based on typical characteristics of tree wells as follows:

It is assumed that each tree and associated trench or box is considered a single BMP, with calculations based on the media storage volume and/or the individual tree within the tree BMP as appropriate. Tree credit volume is calculated as:

$$TCV = TIV + TCIV + TETV$$

where:

TCV = Tree credit volume (ft³)

TIV = Total infiltration volume of all storage layers within tree BMPs (ft³)

$TCIV$ = Total canopy interception volume of all individual trees within tree BMPs (ft³)

$TETV$ = Total evapotranspiration volume, sums the media evapotranspiration storage within each tree BMP (ft³)

Total infiltration volume was calculated as the total volume infiltrated within the BMP storage layers. Infiltration volume was assumed to be 20 percent of the total BMP storage layer volume, the available pore space in the soil volume (porosity – field capacity). Total canopy interception volume was calculated for all tree wells within the tributary area as the average interception capacity for the entire mature tree total canopy projection area. Interception capacity was determined to be 0.04 inch for all tree well sizes, an average from the findings published by Breuer et al. (2003) for coniferous and deciduous trees. Total evapotranspiration volume is the available evapotranspiration storage volume (field capacity – wilting point) within the BMP storage layer media. TEVT is assumed to be 10 percent of the minimum soil volume. The minimum soil volume as required by the SD-A fact sheet of 2 ft³ per unit canopy projection area was assumed for estimating reduction in DCV.

B.2.2.2 Rain Barrels

Rain barrels are containers that can capture rooftop runoff and store it for future use. Credit can be taken for the full rain barrel volume when the capacity of each barrel is less than 100 gallons, implemented per the SD-E fact sheet, and meets the following criteria:

- Total rain barrel volume is less than 0.25 DCV and

Appendix B: Storm Water Pollutant Control Hydrologic Calculations and Sizing Methods

- Landscape areas are greater than 30 percent of the project footprint.

Credit for harvest and use systems that do not meet these criteria shall be based on the criteria in Appendix B and the HU-1 fact sheet.

Worksheet B.2-1. DCV

Design Capture Volume		Worksheet B.2-1		
1	85 th percentile 24-hour storm depth from Figure B.1-1	d=		inches
2	Area tributary to BMP (s)	A=		acres
3	Area weighted runoff factor (estimate using Appendices B.1.1 and B.2.1)	C=		unitless
4	Tree well volume reduction	TCV=		ft ³
5	Rain barrel volume reduction	RCV=		ft ³
6	Calculate DCV = (3630 x C x d x A) – TCV - RCV	DCV=		ft ³

B.3 Harvest and Use BMPs

The purpose of this section is to provide guidance for evaluating feasibility of harvest and use BMPs, calculating harvested water demand, and sizing harvest and use BMPs.

B.3.1 Planning Level Harvest and Use Feasibility

Harvest and use feasibility should be evaluated at the scale of the entire project and not limited to a single DMA. For the purpose of initial feasibility screening, it is assumed that harvested water collected from one DMA could be used within another. Types of non-potable water demand that may apply within a project include:

- Toilet and urinal flushing
- Irrigation
- Vehicle washing
- Evaporative cooling
- Dilution water for recycled water systems
- Industrial processes
- Other non-potable uses

Worksheet B.3-1 provides a screening process for determining the preliminary feasibility for harvest and use BMPs. This worksheet should be completed for the overall project.

Appendix B: Storm Water Pollutant Control Hydrologic Calculations and Sizing Methods

Worksheet B.3-1. Harvest and Use Feasibility Screening

Harvest and Use Feasibility Screening	Worksheet B.3-1	
<p>1. Is there a demand for harvested water (check all that apply) at the project site that is reliably present during the wet season?</p> <p style="margin-left: 20px;">Toilet and urinal flushing</p> <p><input type="checkbox"/> Landscape irrigation</p> <p><input type="checkbox"/> Other: _____</p>		
<p><input checked="" type="checkbox"/> If there is a demand; estimate the anticipated average wet season demand over a period of 36 hours. Guidance for planning level demand calculations for toilet/urinal flushing and landscape irrigation is provided in Section B.3.2.</p> <p>[Provide a summary of calculations here]</p>		
<p>3. Calculate the DCV using Worksheet B.2-1.</p> <p>[Provide a result here]</p>		
<p>3a. Is the 36-hour demand greater than or equal to the DCV?</p> <p style="text-align: center;">Yes / No ➡</p> <p style="text-align: center;">↓</p>	<p>3b. Is the 36-hour demand greater than 0.25DCV but less than the full DCV?</p> <p style="text-align: center;">Yes / No ➡</p> <p style="text-align: center;">↓</p>	<p>3c. Is the 36-hour demand less than 0.25 DCV?</p> <p style="text-align: center;">Yes</p> <p style="text-align: center;">↓</p>
<p>Harvest and use appears to be feasible. Conduct more detailed evaluation and sizing calculations to confirm that DCV can be used at an adequate rate to meet drawdown criteria.</p>	<p>Harvest and use may be feasible. Conduct more detailed evaluation and sizing calculations to determine feasibility. Harvest and use may only be able to be used for a portion of the site, or (optionally) the storage may need to be upsized to meet long term capture targets while draining in longer than 36 hours.</p>	<p>Harvest and use are considered to be infeasible.</p>

Note: 36-hour demand calculations are for feasibility analysis only. Once feasibility analysis is complete the applicant may be allowed to use a different drawdown time provided, they meet the 80 percent annual capture standard (refer to Section B.4.2) and 96-hour vector control drawdown requirement.

B.3.2 Harvested Water Demand Calculation

This section provides technical references and guidance for estimating the harvested water demand of a project. These references are intended to be used for the planning phase of a project for feasibility screening purposes.

B.3.2.1 Toilet and Urinal Flushing Demand Calculations

The following guidelines should be followed for computing harvested water demand from toilet and urinal flushing:

- If reclaimed water is planned for use for toilet and urinal flushing, then the demand for harvested storm water is equivalent to the total demand minus the reclaimed water supplied and should be reduced by the amount of reclaimed water that is available during the wet season.
- Demand calculations for toilet and urinal flushing should be based on the average rate of use during the wet season for a typical year.
- Demand calculations should include changes in occupancy over weekends and around holidays and changes in attendance/enrollment over school vacation periods.
- For facilities with generally high demand but periodic shutdowns (e.g., for vacations, maintenance, or other reasons), a project specific analysis should be conducted to determine whether the long-term storm water capture performance of the system can be maintained despite shutdowns.
- Such an analysis should consider the statistical distributions of precipitation and demand, most importantly the relationship of demand to the wet seasons of the year.

Table B.3-1 provides planning-level demand estimates for toilet and urinal flushing per resident, or employee, for a variety of project types. The per capita use per day is based on daily employee or resident usage. For non-residential types of development, the “visitor factor” should be multiplied by the employee use to account for toilet and urinal usage for non-employees using facilities. Project proponents may suggest an alternate per capita use for airport employees and passengers, with approval from P&EAD and ADC.

Note: Table B.3-1 provides a demand estimate for 24 hours; for feasibility analysis, this estimate must be multiplied by 1.5 to calculate the 36-hour demand.

Appendix B: Storm Water Pollutant Control Hydrologic Calculations and Sizing Methods

Table B.3-1. Toilet and Urinal Water Usage per Employee and Visitor

Land Use Type	Toilet User Unit of Normalization	Per Capita Use per Day		Visitor Factor ⁴	Water Efficiency Factor	Total Use per Employee ^{5,6}
		Toilet Flushing ^{1,2}	Urinals ³			
Office	Employee (non-visitor)	9.0	2.27	1.1	0.5	7 (avg)
Retail	Employee (non-visitor)	9.0	2.11	1.4	0.5	
Various Industrial Uses (excludes process water)	Employee (non-visitor)	9.0	2	1	0.5	5.5

Notes:

1. Based on American Waterworks Association Research Foundation, 1999. Residential End Uses of Water. Denver, CO: AWWARF
2. Based on use of 3.45 gallons per flush and average number of per employee flushes per subsector, Table D-1 for MWD (Pacific Institute, 2003)
3. Based on use of 1.6 gallons per flush, Table D-4, and average number of per employee flushes per subsector, Appendix D (Pacific Institute, 2003)
4. Multiplied by the demand for toilet and urinal flushing for the project to account for visitors. Based on proportion of annual use allocated to visitors and others (includes students for schools; about 5 students per employee) for each subsector in Tables D-1 and D-4 (Pacific Institute, 2003)
5. Accounts for requirements to use ultra-low-flush toilets in new development projects; assumes that requirements will reduce toilet and urinal flushing demand by one-half on average compared with literature estimates. Ultra-low-flush toilets are required in all new construction in California as of January 1, 1992. Ultra-low-flush toilets must use no more than 1.6 gallons per flush and ultra-low-flush urinals must use no more than 1 gallon per flush. Note: If zero-flush-urinals are used, adjust accordingly.
6. Project proponents may suggest an alternate usage rate for airport employees and passengers, with approval from P&EAD.

B.3.2.2 General Requirements for Irrigation Demand Calculations

The following guidelines should be used for computing harvested water demand from landscape irrigation:

- If reclaimed water is planned for use for landscape irrigation, then the demand for harvested storm water should be reduced by the amount of reclaimed water that is available during the wet season.
- Irrigation rates should be based on the irrigation demand exerted by the types of landscaping that are proposed for the project, with consideration for water conservation requirements.
- Irrigation rates should be estimated to reflect the average wet season rates (defined as October through April), accounting for the effect of storm events in offsetting harvested water demand. In the absence of a detailed demand study, it should be assumed that irrigation demand is not present during days with greater than 0.1 inch of rainfall and the subsequent 3-day period. This irrigation shutdown period is consistent with standard practice in land application of wastewater and is applicable to storm water to prevent irrigation from resulting in dry weather runoff. Based on a statistical analysis of San Diego County rainfall patterns, approximately 30 percent of wet season days would not have a demand for irrigation.

Appendix B: Storm Water Pollutant Control Hydrologic Calculations and Sizing Methods

- If land application of storm water is proposed (irrigation in excess of agronomic demand), then this BMP must be considered to be an infiltration BMP, and feasibility screening for infiltration must be conducted. In addition, it must be demonstrated that land application would not result in greater quantities of runoff as a result of saturated soils at the beginning of storm events. Agronomic demand refers to the rate at which plants use water.

The following subsections describe methods that should be used to calculate harvested water irrigation demand. Although these methods are simplified, they provide a reasonable estimate of potential harvested water demand that is appropriate for feasibility analysis and project planning. These methods may be replaced by a more rigorous project-specific analysis that meets the intent of the criteria above.

B.3.2.2.1 Demand Calculation Method

This method is based on the San Diego Municipal Code Land Development Code Landscape Standards Appendix E, which includes a formula for estimating a project's annual estimated total water use based on reference evaporation, plant factor, and irrigation efficiency.

For the purpose of calculating harvested water irrigation demand applicable to the sizing of harvest and use systems, the estimated total water use has been modified to reflect typical wet-season irrigation demand. This method assumes that the wet season is defined as October through April. This method further assumes that no irrigation water will be applied during days with precipitation totals greater than 0.1 inch or within the 3 days following such an event. Based on these assumptions and an analysis of Lake Wohlford, Lindbergh, and Oceanside precipitation patterns, irrigation would not be applied during approximately 30 percent of days from October through April.

The following equation is used to calculate the modified estimated total water usage:

$$\text{Modified ETWU} = \text{ET}_{\text{Owet}} \times [([\Sigma(\text{PF} \times \text{HA})/\text{IE}] + \text{SLA}) \times 0.015]$$

where:

Modified ETWU = Estimated daily average water usage during wet season

ET_{Owet} = Average reference evapotranspiration from October through April (use 2.8 inches per month, using CIMS Zone 4 from Table G.1-1)

PF = plant factor

HA = Hydrozone Area (ft²); A section or zone of the landscaped area having plants with similar water needs.

$\Sigma(\text{PF} \times \text{HA})$ = The sum of PF x HA for each individual hydrozone (accounts for different landscaping zones).

IE = Irrigation efficiency (assume 90 percent for demand calculations)

SLA = Special landscape area (ft²); areas used for active and passive recreation areas, areas solely dedicated to the production of fruits and vegetables, and areas irrigated with reclaimed water.

Appendix B: Storm Water Pollutant Control Hydrologic Calculations and Sizing Methods

Table B.3-2. Planning-Level Plant Factor Recommendations

Plant Water Use	Plant Factor	Also Includes
Low	< 0.1–0.2	Artificial Turf
Moderate	0.3–0.7	
High	0.8 and greater	Water features
Special Landscape Area	1.0	

In this equation, the coefficient (0.015) accounts for unit conversions and shutdown of irrigation during and for the 3 days following a significant precipitation event:

$$0.015 = (1 \text{ mo}/30 \text{ days}) \times (1 \text{ ft}/12 \text{ in}) \times (7.48 \text{ gal}/\text{ft}^3) \times (\text{approximately } 7 \text{ of } 10 \text{ days with irrigation demand from October through April})$$

B.3.2.2.2 Planning-Level Irrigation Demands

To simplify the planning process, the method described above has been used to develop daily average wet season demands for a 1-acre irrigated area based on the plant/landscape type. These demand estimates can be used to calculate the drawdown of harvest and use systems for the purpose of LID BMP sizing calculations.

Table B.3-3. Planning-Level Irrigation Demand by Plant Factor and Landscape Type

General Landscape Type	36-Hour Planning Level Irrigation Demand (Gallons per irrigated acre per 36-hour period)
Hydrozone – Low Plant Water Use	390
Hydrozone – Moderate Plant Water Use	1,470
Hydrozone – High Plant Water Use	2,640
Special Landscape Area	2,640

B.3.2.3 Calculating Other Harvested Water Demands

Calculations of other harvested water demands should be based on the knowledge of land uses, industrial processes, and other factors that are project specific. Demand should be calculated based on the following guidelines:

- Demand calculations should represent actual demand that is anticipated during the wet season (October through April).
- Sources of demand should be included only if they are reliably and consistently present during the wet season.

Appendix B: Storm Water Pollutant Control Hydrologic Calculations and Sizing Methods

- Where demands are substantial but irregular, a more detailed analysis should be conducted based on a statistical analysis of anticipated demand and precipitation patterns.

B.3.3 Sizing Harvest and Use BMPs

Sizing calculations shall demonstrate that one of two equivalent performance standards is met:

- 1) Harvest and use BMPs are sized to drain the tank in 36 hours following the end of rainfall. The size of the BMP is dependent on the demand (Section B.3.2) at the site, OR
- 2) Harvest and use BMPs are designed to capture at least 80 percent of average annual (long-term) runoff volume.

It is rare that cisterns can be sized to capture the full DCV and use this volume in 36 hours. So, when using Worksheet B.3-1, if it is determined that a harvest and use BMP is feasible, then the BMP should be sized to the estimated 36-hour demand. The applicant has the option to design the harvest and use BMP for greater demand, but the BMP must then be made larger to account for back-to-back storms. This increase in sizing can be estimated using the nomograph presented in Figure B.4-1.

According to the California Department of Health, structural BMPs that retain standing water for over 96 hours are particularly concerning for facilitating mosquito breeding. Cisterns designed for the 96-hour demand or greater should incorporate appropriate vector controls, and a vector control plan must be submitted to P&EAD.

B.4 Infiltration BMPs

Sizing calculations shall demonstrate that one of two equivalent performance standards is met:

- 1) The BMP or series of BMPs captures the DCV and infiltrates this volume fully within 36 hours following the end of precipitation. This can be demonstrated through the Simple Method (Section B.4.1).
- 2) The BMP or series of BMPs infiltrates at least 80 percent of average annual (long-term) runoff volume. This can be demonstrated using the percent capture method (Section B.4.2), through reporting of output from the San Diego Hydrology Model, or through other continuous simulation modeling meeting the criteria in Appendix G, as acceptable to the P&EAD and ADC. This method is **not** applicable for sizing biofiltration BMPs.

The methods to show compliance with these standards are provided in the following sections.

B.4.1 Simple Method

Stepwise Instructions:

- 1) Compute DCV using Worksheet B.4-1.
- 2) Estimate design infiltration rate using Worksheet D.5-1.
- 3) Design BMP(s) to ensure that the DCV is fully retained (i.e., no surface discharge during the design event) and the stored effective depth draws down in no longer than 36 hours.

Worksheet B.4-1. Simple Sizing Method for Infiltration BMPs

Simple Sizing Method for Infiltration BMPs		Worksheet B.4-1		
1	DCV (Worksheet B.2-1)	DCV=		ft ³
2	Estimated design infiltration rate	K _{design} =		inches/ hour
3	Available BMP surface area	A _{BMP} =		ft ²
4	Average effective depth in the BMP footprint (DCV/A _{BMP})	D _{avg} =		feet
5	Drawdown time, T (D _{avg} *12/K _{design})	T=		hours
6	Provide alternative calculation of drawdown time, if needed.			
7	Provide calculations for effective depth provided in the BMP. Effective depth = Surface ponding (below the overflow elevation) + gravel storage thickness x gravel porosity (0.4)			

Notes:

- Drawdown time must be less than 36 hours. This criterion was set to achieve average annual capture of 80 percent to account for back-to-back storms (See rationale in Section B.4.3). To use a different drawdown time, BMPs should be sized using the percent capture method (Section B.4.2).
- The average effective depth calculation should account for any aggregate/medium in the BMP. For example, 4 feet of stone at a porosity of 0.4 would equate to 1.6 feet of effective depth.

Appendix B: Storm Water Pollutant Control Hydrologic Calculations and Sizing Methods

- This method may overestimate drawdown time for BMPs that drain through both the bottom and walls of the system. BMP specific calculations of drawdown time may be provided that account for BMP-specific geometry.

B.4.2 Percent Capture Method

This section describes the recommended method of sizing volume-based BMPs to achieve the 80 percent capture performance criterion. This method has a number of potential applications for sizing BMPs:

- Use this method when a BMP can draw down in less than 36 hours and it is desired to demonstrate that 80 percent capture can be achieved using a BMP volume smaller than the DCV.
- Use this method to determine how much volume (greater than the DCV) must be provided to achieve 80 percent capture when the drawdown time of the BMP exceeds 36 hours. **Note:** if the drawdown time exceeds 96 hours, appropriate vector control should be incorporated.
- Use this method to determine how much volume should be provided to achieve 80 percent capture when upstream BMP(s) have achieved some capture but have not achieved 80 percent capture.

By nature, the percent capture method is an iterative process that requires some initial assumptions about BMP design parameters and subsequent confirmation that these assumptions are valid. For example, sizing calculations depend on the assumed drawdown time, which depends on BMP depth, which may in turn need to be adjusted to provide the required volume within the allowable footprint. In general, the selection of reasonable BMP design parameters in the first iteration will result in minimal required additional iterations. Figure B.4-1 presents the nomograph for use in sizing retention BMPs in San Diego County.

Appendix B: Storm Water Pollutant Control Hydrologic Calculations and Sizing Methods

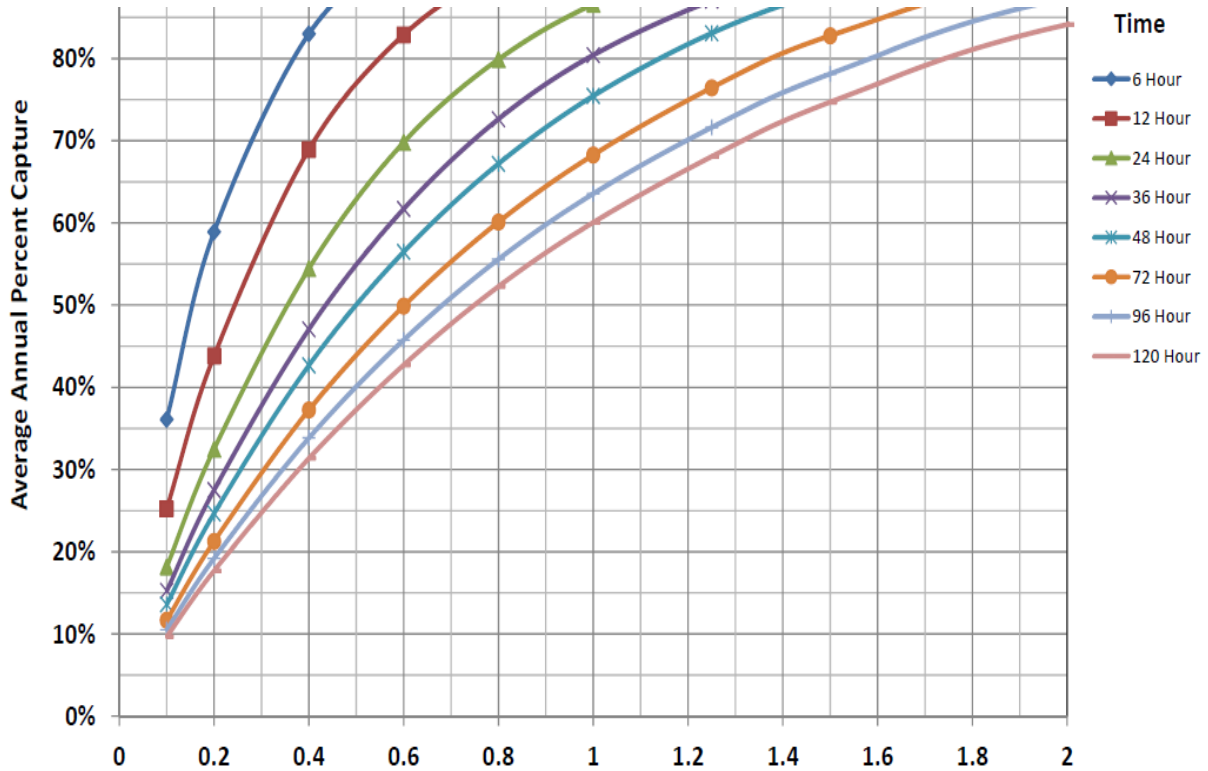

Figure B.4-1. Percent Capture Nomograph

B.4.2.1 Stepwise Instructions for Sizing a Single BMP

- 1) Estimate the drawdown time of the proposed BMP by estimating the design infiltration rate (Worksheet D.5-1) and accounting for BMP dimensions/geometry. See the applicable BMP fact sheet for specific guidance on converting BMP geometry to estimated drawdown time.
- 2) Using the estimated drawdown time and the nomograph from Figure B.4-1, locate where the line corresponding to the estimated drawdown time intersects with 80 percent capture. Pivot to the X axis and read the fraction of the DCV that must be provided in the BMP to achieve this level of capture.
- 3) Calculate the DCV using Worksheet B.2-1.
- 4) Multiply the result of Step 2 by the DCV (Step 3). This is the required BMP design volume.
- 5) Design the BMP to retain the required volume and confirm that the drawdown time is no more than 25 percent greater than estimated in Step 1. If the computed drawdown time is greater than 125 percent of the estimated drawdown, then return to Step 1 and revise the initial drawdown time assumption.

See the respective BMP facts sheets for BMP-specific instructions for the calculation of volume and drawdown time. The method above can also be used to size and/or evaluate the performance of other retention BMPs (evapotranspiration, harvest and use) that have a drawdown rate that can be approximated as a constant throughout the year or over the wet season. To use this method for other

Appendix B: Storm Water Pollutant Control Hydrologic Calculations and Sizing Methods

retention BMPs, drawdown time in Step 1 will need to be evaluated using an applicable method for the type of BMP selected. After completing Step 1 continue to Step 2 listed above.

Example B.4.2.1. Percent Capture Method for Sizing a Single BMP

Given:
<ul style="list-style-type: none"> • Estimated drawdown time: 72 hours • DCV: 3000 ft³
Required:
<ul style="list-style-type: none"> • Determine the volume required to achieve 80 percent capture.
Solution:
<ol style="list-style-type: none"> 1) Estimated drawdown time = 72 hours 2) Fraction of DCV required = 1.35 3) DCV = 3,000 ft³ (given for this example; to be estimated using Worksheet B.2-1) 4) Required BMP volume = 1.35 x 3000 = 4050 ft³ 5) Design BMP and confirm drawdown time is ≤ 90 hours (72 hours +25%)

Example B.4.2.1 Continued

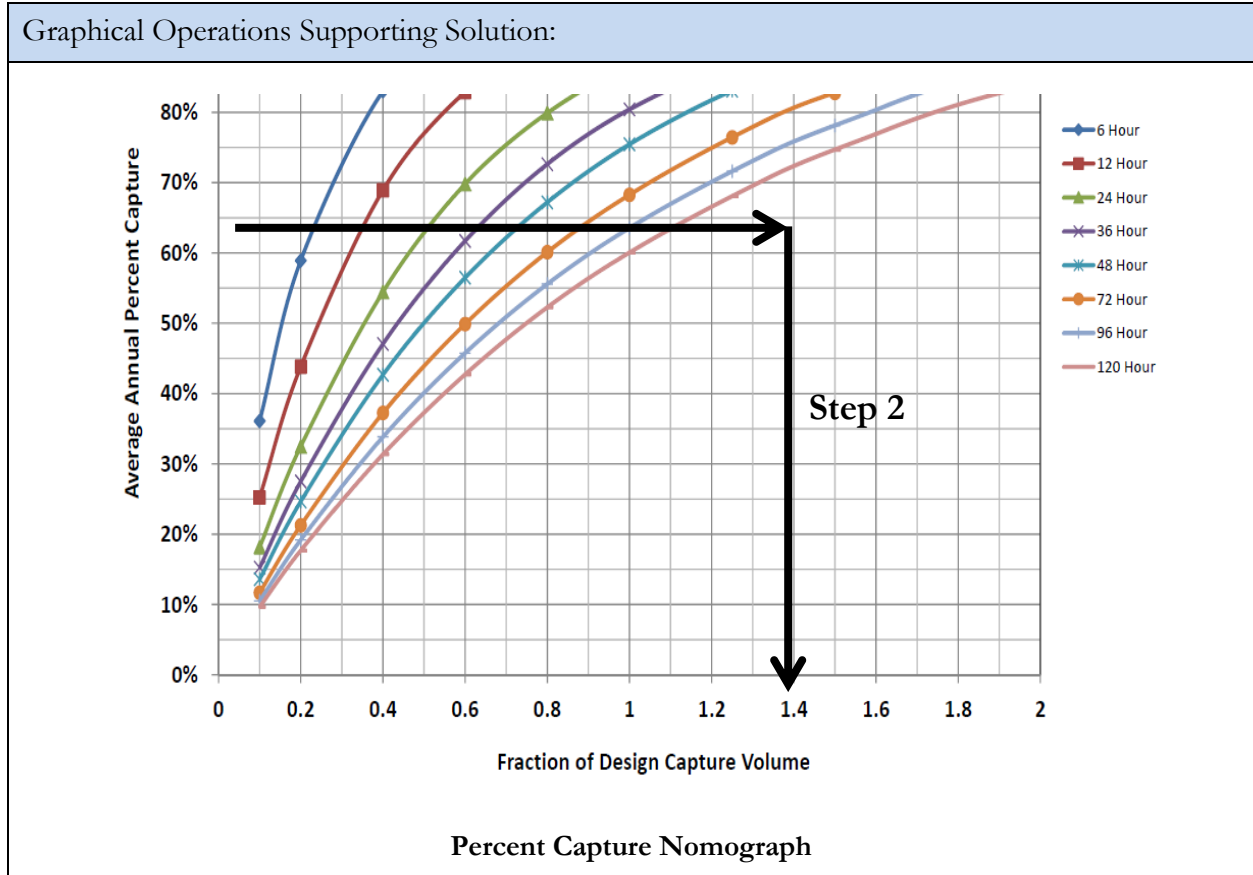

Appendix B: Storm Water Pollutant Control Hydrologic Calculations and Sizing Methods

B.4.2.2 Stepwise Instructions for Sizing BMPs in Series

For projects in which BMPs in series must be implemented to meet the performance standard, the following stepwise procedure shall be used to size the downstream BMP to achieve the 80 percent capture performance criterion:

- 1) Using the upstream BMP parameters (volume and drawdown time), estimate the average annual capture efficiency achieved by the upstream BMP using the nomograph.
- 2) Estimate the drawdown time of the proposed downstream BMP by estimating the design infiltration rate (Worksheet D.5-1) and accounting for BMP dimensions/geometry. See the applicable BMP Fact Sheet for specific guidance on how to convert BMP geometry to estimated drawdown time. Use the nomograph and locate where the line corresponding to the estimated drawdown time intersects with 80 percent capture. Pivot to the horizontal axis and read the fraction of the DCV that needs to be provided in the BMP. This is referred to as X_1 .
- 3) Trace a horizontal line on the nomograph using the capture efficiency of the upstream BMP estimated in Step 1. Find where the line traced intersects with the drawdown time of the downstream BMP (Step 2). Pivot and read down to the horizontal axis to yield the fraction of the DCV already provided by the upstream BMP. This is referred to as X_2 .
- 4) Subtract X_2 (Step 3) from X_1 (Step 2) to determine the fraction of the design volume that must be provided in the downstream BMP to achieve 80 percent capture to meet the performance standard.
- 5) Multiply the result of Step 4 by the DCV. This is the required downstream BMP design volume.
- 6) Design the BMP to retain the required volume and confirm that the drawdown time is no more than 25 percent greater than estimated in Step 2. If the computed drawdown time is greater than 125 percent of the estimated drawdown, then return to Step 2 and revise the initial drawdown time assumption.

See the respective BMP facts sheets for BMP-specific instructions for the calculation of volume and drawdown time.

Appendix B: Storm Water Pollutant Control Hydrologic Calculations and Sizing Methods

Example B.4.2.2. Percent Capture Method for Sizing BMPs in Series

Given:
<ul style="list-style-type: none">• Estimated drawdown time for downstream BMP: 72 Hours• DCV for the area draining to the BMP: 3000 ft³• Upstream BMP volume: 900 ft³• Upstream BMP drawdown time: 24 hours
Required:
<ul style="list-style-type: none">• Determine the volume required in the downstream BMP to achieve 80% capture.
Solution:
<ol style="list-style-type: none">1) Step 1A: Upstream BMP Capture Ratio = $900/3000 = 0.3$; Step 1B: Average annual capture efficiency achieved by upstream BMP = 44%2) Downstream BMP drawdown = 72 hours; Fraction of DCV required to achieve 80% capture = 1.353) Locate intersection of design capture efficiency and drawdown time for upstream BMP (See Graph); Fraction of DCV already provided (X_2) = 0.50 (See Graph)4) Fraction of DCV Required by downstream BMP = $1.35 - 0.50 = 0.85$5) DCV (given) = 3000 ft³; Required downstream BMP volume = $3000 \text{ ft}^3 \times 0.85 = 2,550 \text{ ft}^3$6) Design BMP and confirm drawdown time is ≤ 90 Hours (72 Hours +25%)

Example B.4.2.2 Continued

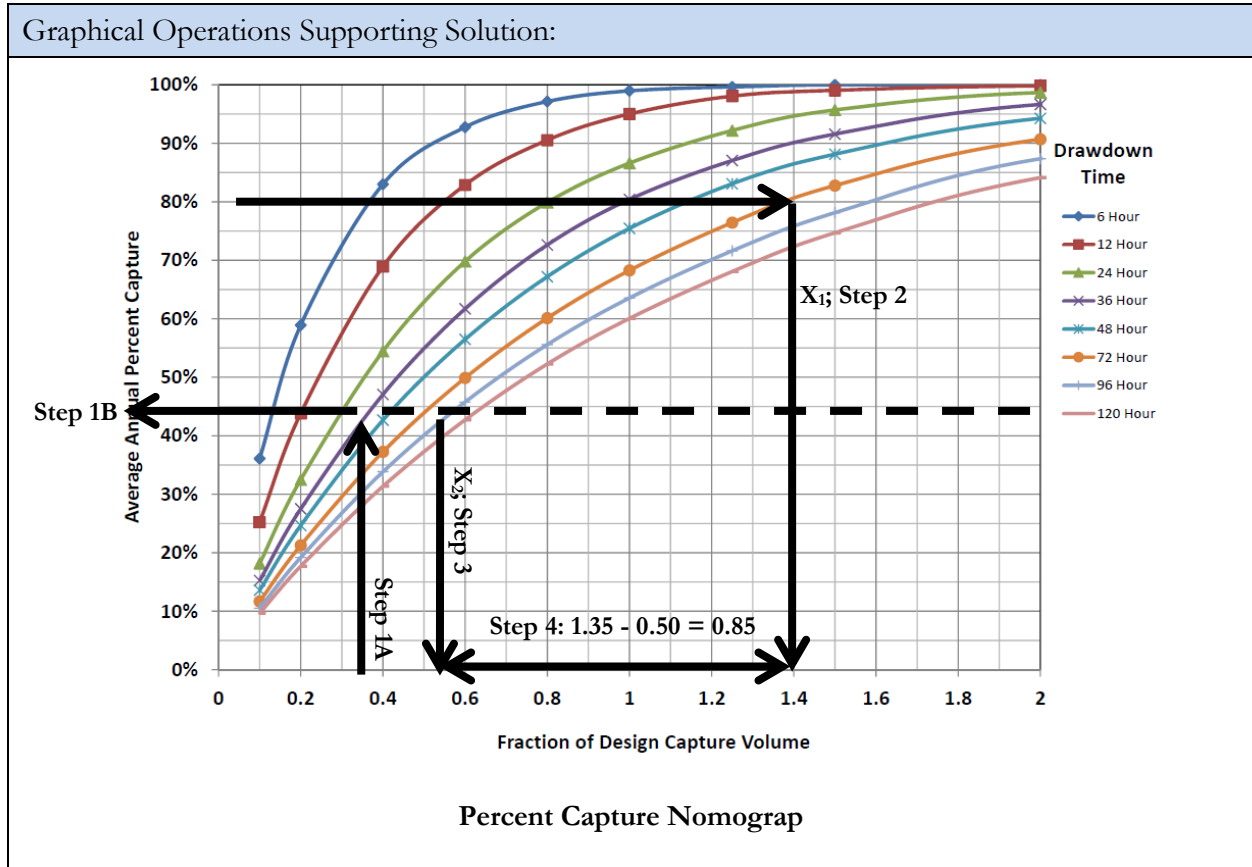

B.4.3 Technical Basis for Equivalent Sizing Methods

Storm water BMPs can be conceptualized as having a storage volume and a treatment rate, in various proportions. Both are important in the long-term performance of the BMP under a range of actual storm patterns, depths, and inter-event times. Long-term performance is measured by the operation of a BMP over the course of multiple years and provides a more complete metric than the performance of a BMP during a single event, which does not take into account antecedent conditions, including multiple storms arriving in short timeframes. A BMP that draws down more quickly would be expected to capture a greater fraction of overall runoff (i.e., long-term runoff) than an identically sized BMP that draws down more slowly. This is because storage is made available more quickly, so subsequent storms are more likely to be captured by the BMP. In contrast, a BMP with a long drawdown time would stay mostly full, after initial filling, during periods of sequential storms. The volume in the BMP that draws down more quickly is more “valuable” in terms of long-term performance than the volume in the one that draws down more slowly. The MS4 Permit definition of the DCV does not specify a drawdown time; therefore, the definition is not a complete indicator of a BMP's level of performance. An accompanying performance-based expression of the BMP sizing standard is essential to ensure uniformity of performance across a broad range of BMPs and helps prevent BMP designs from being used that would not be effective.

Appendix B: Storm Water Pollutant Control Hydrologic Calculations and Sizing Methods

The relationships between BMP design parameters and expected long-term capture efficiency have been evaluated to address the needs identified above. Relationships have been developed through a simplified continuous simulation analysis of precipitation, runoff, and routing that relate BMP design volume and storage recovery rate (i.e., drawdown time) to an estimated long-term level of performance using United States Environmental Protection Agency (USEPA) SWMM and parameters listed in Appendix G for Lake Wohlford, Lindbergh, and Oceanside rain gauges. Comparison of the relationships developed using the three gauges indicated that the differences in relative capture estimates are within the uncertainties in factors used to develop the relationships. For example, the estimated average annual capture for the BMP sized for the DCV and 36-hour drawdown using Lake Wohlford, Lindbergh, and Oceanside rain gauges are 80 percent, 76 percent, and 83 percent respectively. In an effort to reduce the number of curves that are made available, relationships developed using Lake Wohlford rain gauge data are included in this Manual for use in the whole San Diego County region.

Figure B.4-1 demonstrated that a BMP sized for the runoff volume from the 24-hour, 85th percentile storm event (i.e., the DCV) that draws down in 36 hours is capable of managing approximately 80 percent of the average annual. There is long precedent for 80 percent capture of average annual runoff as approximately the point at which larger BMPs provide decreasing capture efficiency benefit (also known as the “knee of the curve”) for BMP sizing. The characteristic shape of the plot of capture efficiency versus storage volume in Figure B.4-1 illustrates this concept.

As such, this equivalency (between DCV draw down in 36 hours and 80 percent capture) has been used to provide a common currency between volume-based BMPs with a wide range of drawdown rates. This approach allows flexibility in the design of BMPs while ensuring consistent performance.

B.5 Biofiltration BMPs

Biofiltration BMPs shall be sized by one of the following sizing methods:

Option 1: Treat 1.5 times the portion of the DCV not reliably retained onsite, OR

Option 2: Treat 1.0 times the portion of the DCV not reliably retained onsite; and additionally check that the system has a total static (i.e., non-routed) storage volume, including pore spaces and pre-filter detention volume, equal to at least 0.75 times the portion of the DCV not reliably retained onsite.

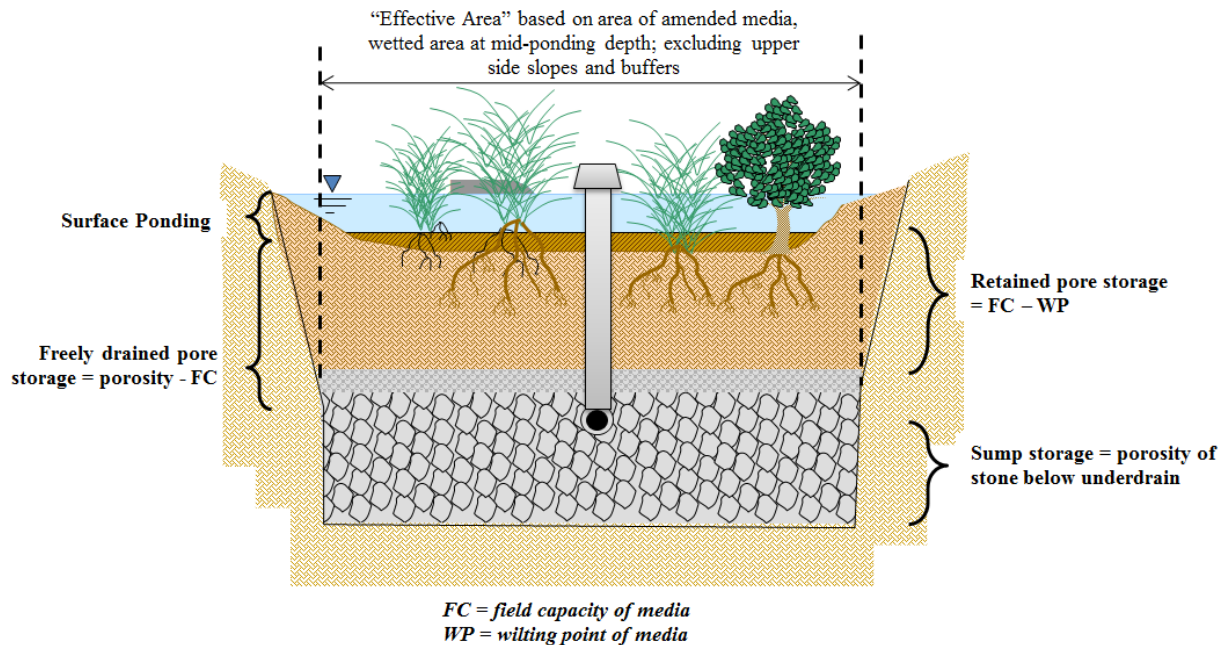

Explanation of Biofiltration Volume Compartments for Sizing Purposes

Worksheet B.5-1 provides a simple sizing method for sizing biofiltration BMP with partial retention and biofiltration BMP.

When using sizing option 1 a routing period of 6 hours is allowed. The routing period was estimated based on 50th percentile storm duration for storms similar to 85th percentile rainfall depth. It was estimated based on inspection of continuous rainfall data from Lake Wohlford, Lindbergh, and Oceanside rain gauges.

Appendix B: Storm Water Pollutant Control Hydrologic Calculations and Sizing Methods

Worksheet B.5-1. Simple Sizing Method for Biofiltration BMPs

Simple Sizing Method for Biofiltration BMPs		Worksheet B.5-1 (Page 1 of 2)	
1	Remaining DCV after implementing retention BMPs		ft ³
Partial Retention			
2	Infiltration rate from Worksheet D.5-1 if partial infiltration is feasible		inches/hour
3	Allowable drawdown time for aggregate storage below the underdrain	36	hours
4	Depth of runoff that can be infiltrated [Line 2 x Line 3]		inches
5	Aggregate pore space	0.40	inches/inch
6	Required depth of gravel below the underdrain [Line 4/ Line 5]		inches
7	Assumed surface area of the biofiltration BMP		ft ²
8	Media retained pore storage	0.1	inches/inch
9	Volume retained by BMP [(Line 4 + (Line 12 x Line 8))/12] x Line 7		ft ³
10	DCV that requires biofiltration [Line 1 – Line 9]		ft ³
BMP Parameters			
11	Surface Ponding [6 inch minimum, 12 inch maximum]		inches
12	Media Thickness [18 inches minimum], also add mulch layer thickness to this line for sizing calculations		inches
13	Aggregate Storage above underdrain invert (12 inches typical) – use 0 inches for sizing if the aggregate is not over the entire bottom surface area		inches
14	Media available pore space	0.2	inches/inch
15	Media filtration rate to be used for sizing (5 inches/hour with no outlet control; if the filtration rate is controlled by the outlet use the outlet-controlled rate)	5	inches/hour
Baseline Calculations			
16	Allowable Routing Time for sizing	6	hours
17	Depth filtered during storm [Line 15 x Line 16]	30	inches
18	Depth of Detention Storage [Line 11 + (Line 12 x Line 14) + (Line 13 x Line 5)]		inches
19	Total Depth Treated [Line 17 + Line 18]		inches

Appendix B: Storm Water Pollutant Control Hydrologic Calculations and Sizing Methods

Worksheet B.5-1. Simple Sizing Method for Biofiltration BMPs (continued)

Simple Sizing Method for Biofiltration BMPs		Worksheet B.5-1 (Page 2 of 2)	
Option 1 – Biofilter 1.5 times the DCV			
20	Required biofiltered volume [1.5 x Line 10]		ft ³
21	Required Footprint [Line 20/ Line 19] x 12		ft ²
Option 2 - Store 0.75 of remaining DCV in pores and ponding			
22	Required Storage (surface + pores) Volume [0.75 x Line 10]		ft ³
23	Required Footprint [Line 22/ Line 18] x 12		ft ²
Footprint of the BMP			
24	Area draining to the BMP		ft ²
25	Adjusted Runoff Factor for drainage area (Refer to Appendices B.1 and B.2)		
26	BMP Footprint Sizing Factor (Default 0.03 or an alternative minimum footprint sizing factor from Worksheet B.5-2, Line 11)		unitless
27	Minimum BMP Footprint [Line 24 x Line 25 x Line 26]		ft ²
28	Footprint of the BMP = Maximum (Minimum (Line 21, Line 23), Line 27)		ft ²
Check for Volume Reduction [Not applicable for No Infiltration Condition]			
29	Calculate the fraction of the DCV retained by the BMP [Line 9/ Line 1]		unitless
30	Minimum required fraction of DCV retained for partial infiltration condition	0.375	unitless
31	Is the retained DCV > 0.375? If the answer is no increase the footprint sizing factor in Line 26 until the answer is yes for this criterion.	<input type="checkbox"/> Yes <input type="checkbox"/> No	

Notes:

- Line 7 is used to estimate the amount of volume retained by the BMP. Update assumed surface area in Line 7 until its equivalent to the required biofiltration footprint (either Line 21 or Line 23)
- The DCV fraction of 0.375 is based on a 40% average annual percent capture and a 36-hour drawdown time.
- The increase in footprint for volume reduction can be optimized using the approach presented in Appendix B.5.2. The optimized footprint cannot be smaller than the alternative minimum footprint sizing factor from Worksheet B.5-2.
- If the proposed biofiltration BMP footprint is smaller than the alternative minimum footprint sizing factor from Worksheet B.5-2, but satisfies Option 1 or Option 2 sizing, it is considered a compact biofiltration BMP and may be allowed at the discretion of the P&EAD and ADC, if it meets the requirements in Appendix F.

B.5.1 Basis for Minimum Sizing Factor for Biofiltration BMPs

B.5.1.1 Introduction

MS4 Permit Provision E.3.c.(1)(a)(i)

The MS4 Permit describes conceptual performance goals for biofiltration BMPs and specifies numeric criteria for sizing biofiltration BMPs (see Section 2.2.1 of this Manual).

However, the MS4 Permit does not define a specific footprint sizing factor or design profile that must be provided for the BMP to be considered “biofiltration.” Rather, the MS4 Permit specifies (Footnote 25):

As part of the Copermittee’s update to its BMP Design Manual, pursuant to MS4 Permit Provision E.3.d, the Copermittee must provide guidance for hydraulic loading rates and other biofiltration design criteria necessary to maximize storm water retention and pollutant removal.

To meet this provision, this Manual includes specific criteria for design of biofiltration BMPs. Among other criteria, a minimum footprint sizing factor of 3 percent (BMP footprint area as percentage of contributing area multiplied by the adjusted runoff factor) is specified. The purpose of this section is to provide the technical rationale for this 3 percent minimum sizing factor.

B.5.1.2 Conceptual Need for Minimum Sizing Factor

Under the 2011 Model Standard Urban Stormwater Mitigation Plan (SUSMP), a sizing factor of 4 percent was used to size biofiltration BMPs. This value was derived based on the goal of treating the runoff from a 0.2-inch-per-hour uniform precipitation intensity at a constant media flow rate of 5 inches per hour. Although this method was simple, it was considered to be conservative because it did not account for significant transient storage present in biofiltration BMPs (i.e., volume in surface storage and subsurface storage that would need to fill before overflow occurred). Under this Manual, biofiltration BMPs will typically provide subsurface storage to promote infiltration losses; therefore, typical BMP profiles will tend to be somewhat deeper than those provided under the 2011 Model SUSMP. A deeper profile will tend to provide more transient storage and allow smaller footprint sizing factors while still providing similar or better treatment capacity and pollutant removal. Therefore, a reduction in the minimum sizing factor from the factor used in the 2011 Model SUSMP is supportable. However, as footprint decreases, issues related to potential performance, operations, and/or maintenance can increase for a number of reasons:

- 1) As the surface area of the media bed decreases, the sediment loading per unit area increases, increasing the risk of clogging. Although vigorous plant growth can help maintain permeability of soil, there is a conceptual limit above which plants may not be able to mitigate for the sediment loading. Scientific knowledge is not conclusive in this area.
- 2) With smaller surface areas and greater potential for clogging, water may be more likely to bypass the system via overflow before filling up the profile of the BMP.

Appendix B: Storm Water Pollutant Control Hydrologic Calculations and Sizing Methods

- 3) As the footprint of the system decreases, the amount of water that can be infiltrated from subsurface storage layers and evapotranspire from plants and soils tends to decrease.
- 4) With smaller sizing factors, the hydraulic loading per unit area increases, potentially reducing the average contact time of water in the soil media and diminishing treatment performance.

The MS4 Permit requires that volume and pollutant retention be maximized. Therefore, a minimum sizing factor was determined to be needed. This minimum sizing factor does not replace the need to conduct sizing calculations as described in this Manual; rather it establishes a lower limit on required size of biofiltration BMPs as the last step in these calculations. Additionally, it does not apply to alternative biofiltration designs that utilize the checklist in Appendix F (Biofiltration Standard and Checklist). Acceptable alternative designs (such as proprietary systems meeting Appendix F criteria) typically include design features intended to allow acceptable performance with a smaller footprint and have undergone field scale testing to evaluate performance and required O&M frequency.

B.5.1.3 Lines of Evidence to Select Minimum Sizing Factor

Three primary lines of evidence were used to select the minimum sizing factor of 3 percent (BMP footprint area as a percentage of contributing area multiplied by adjusted runoff factor) in this Manual:

- 1) Typical design calculations
- 2) Volume reduction performance
- 3) Sediment clogging calculations

These lines of evidence and associated findings are explained in this section.

Typical Design Calculations

A range of BMP profiles were evaluated for different design rainfall depths and soil conditions. Worksheet B.5-1 was used for each case to compute the required footprint sizing factor. For these calculations, the amount of water filtered during the storm event was determined based on a media filtration rate of 5 inches per hour and a routing time of 6 hours. These input assumptions are considered to be well supported and consistent with the intent of the MS4 Permit. These calculations generally yielded footprint factors from 1.5 to 4.9 percent. In the interest of establishing a uniform San Diego County-wide minimum sizing factor, a 3 percent sizing factor was selected from this range, consistent with other lines of evidence.

Volume Reduction Performance

Consistent with guidance in Fact Sheet PR-1, the amount of retention storage (in gravel sump below underdrain) that would drain in 36 hours was calculated for a range of soil types. This value was used to estimate the volume reduction that would be expected to be achieved. For a sizing factor of 3 percent and a soil filtration rate of 0.20 inch per hour, the average annual volume reduction was estimated to be approximately 40 percent (via percent capture method; see Appendix B.4.2).

In describing the basis for equivalency between retention and biofiltration (1.5 multiplier), the MS4 Permit Fact Sheet referred to analysis prepared in the Ventura County Technical Guidance Manual. The Ventura County analysis considered the pollutant treatment as well as the volume reduction provided by biofiltration in considering equivalency to retention. This analysis assumed an average

Appendix B: Storm Water Pollutant Control Hydrologic Calculations and Sizing Methods

long-term volume reduction of 40 percent based on analysis of data from the International Stormwater BMP Database. The calculations of estimated volume reduction at a 3 percent sizing factor are (previous paragraph) consistent with this value. Although estimated volume reduction is sensitive to site-specific factors, this analysis indicates that a sizing factor of approximately 3 percent provides levels of volume reduction that are reasonably consistent with the intent of the MS4 Permit.

Sediment Clogging Calculations

As sediment accumulates in a filter, the permeability of the filter tends to decline. The lifespan of the filter bed can be estimated by determining the rate of sediment loading per unit area of the filter bed. To determine the media bed surface area sizing factor needed to provide a target lifespan, simple sediment loading calculations were conducted based on typical urban conditions. The inputs and results of this calculation are summarized in Table B.5-1.

Table B.5-1. Inputs and Results of Clogging Calculation

Parameter	Value	Source
Representative Total Suspended Solids (TSS) Event Mean Concentration, mg/L	100	Approximate average of San Diego Land Use Event Mean Concentrations from San Diego River and San Luis Rey River Watershed Management Area (WMA) Water Quality Improvement Plan (WQIP)
Runoff Coefficient of Impervious Surface	0.90	Table B.1-1
Runoff Coefficient of Pervious Surface	0.10	Table B.1-1 for landscape areas
Imperviousness	40% to 90%	Planning level assumption, covers typical range of single family to commercial land uses
Average Annual Precipitation, inches	11 to 13	Typical range for much of urbanized San Diego County
Load to Initial Maintenance, kg/m ²	10	Pitt, R. and S. Clark, 2010. Evaluation of Biofiltration Media for Engineered Natural Treatment Systems.
Allowable period to initial clogging, year	10	Planning-level assumption
Estimated BMP Footprint Needed for 10-Year Design Life	2.8% to 3.3%	Calculated

This analysis indicates that a 3 percent sizing factor, coupled with sediment source controls and careful system design, should provide reasonable protection against premature clogging. However, there is substantial uncertainty in sediment loading and the actual load to clog that will be observed under field conditions in the San Diego climate. Additionally, this analysis did not account for the effect of plants on maintaining soil permeability. Therefore, this line of evidence should be considered provisional, subject to refinement based on field scale experience. Because field-scale experience is gained about the lifespan of biofiltration BMPs in San Diego and the mitigating effects of plants on long-term clogging, it may be possible to justify lower factors of safety and therefore smaller design sizes in some cases. If a longer lifespan is desired and/or greater sediment load is expected, then a larger sizing factor may be justified.

Appendix B: Storm Water Pollutant Control Hydrologic Calculations and Sizing Methods

B.5.1.4 Discussion

Generally, the purpose of a minimum sizing factor is to help improve the performance and reliability of standard biofiltration systems and limit the use of sizing methods and assumptions that may lead to designs that are less consistent with the intent of the MS4 Permit.

Ultimately, this factor is a surrogate for a variety of design considerations, including clogging and associated hydraulic capacity, volume reduction potential, and treatment contact time. A prudent design approach should consider each of these factors on a project-specific basis and identify whether site conditions warrant a larger or smaller factor. For example, a system treating only rooftop runoff in an area without any allowable infiltration may have negligible clogging risk and negligible volume reduction potential – a smaller sizing factor may not substantially reduce performance in either of these areas. Alternatively, for a site with high sediment load and limited pre-treatment potential, a larger sizing factor may be warranted to help mitigate potential clogging risks. P&EAD and ADC have discretion to accept alternative sizing factor(s) based on project-specific or jurisdiction-specific considerations. Additionally, the recommended minimum sizing factor may change over time as more experience with biofiltration is obtained.

Worksheet B.5-2 is used to support a request for an alternative minimum footprint sizing factor. Based on a review of the submitted worksheet and supporting documentation, the use of a smaller footprint sizing factor may be approved at the discretion of the P&EAD and ADC. If approved, the estimated footprint from the worksheet below can be used in line 26 of worksheet B.5-1 in lieu of the 3 percent minimum footprint value.

This worksheet includes the following general steps to calculate the minimum footprint sizing factor:

- Select a “load to clog” that is representative of the type of BMP proposed.
- Select a target life span (i.e., frequency of major maintenance) that is acceptable to the P&EAD and ADC. A default value of 10 years is recommended.
- Compile information about the DMA from other parts of the SWQMP development process.
- Determine the event mean concentration (EMC) of total suspended solids (TSS) that is appropriate for the DMA
- Perform calculations to determine the minimum footprint to provide the target lifespan.

Appendix B: Storm Water Pollutant Control Hydrologic Calculations and Sizing Methods

Worksheet B.5-2. Calculation of Alternative Minimum Footprint Sizing Factor

Alternative Minimum Footprint Sizing Factor		Worksheet B.5-2 (Page 1 of 2)	
1	Area draining to the BMP		ft ²
2	Adjusted Runoff Factor for drainage area (Refer to Appendix B.1 and B.2)		
3	Load to Clog ¹ (See Table B.5-2 for guidance; L _c)	2.0	pounds/ ft ²
4	Allowable Period to Accumulate Clogging Load (T ₁)	10	years
Volume Weighted EMC Calculation			
	Land Use	Fraction of Total DCV	TSS EMC (mg/L)
	Single Family Residential		123
	Commercial		128
	Industrial		125
	Education (Municipal)		132
	Transportation		78
	Multi-family Residential		40
	Roof Runoff		14
	Low Traffic Areas		50
	Open Space		216
	Other, specify:		
	Other, specify:		
	Other, specify:		
5	Volume Weighted EMC (sum of all products)		mg/L
BMP Parameters			
6	If pretreatment measures are included in the design, apply an adjustment of 25% ² [Line 5 x (1-0.25)]		mg/L
7	Average Annual Precipitation		inches
8	Calculate the Average Annual Runoff (Line 7 x 43,560/12) x Line 2		ft ² /year
9	Calculate the Average Annual TSS Load (Line 8 x 62.4 x Line 6)/10 ⁶		pounds/ year
10	Calculate the BMP Footprint Needed (Line 9 x Line 4)/Line 3		ft ²
11	Calculate the Alternative Minimum Footprint Sizing Factor [Line 10/ (Line 1 x Line 2)]		

¹ Load to clog value should be in the range of 2 – 5 pounds/ft² per Pitt and Clark (2010). If selecting a value other than 2, a justification for the value selected is required. See guidance in Table B.5-2.

² A value of 25 percent is supported by Maniquiz-Redillas et al. (2014) study, which found a pretreatment sediment capture range of 15%–35%. If using a value outside of this range, documentation of the selected value is required. A value of 50 percent can be claimed for a system with an active Washington State TAPE approval rating for “pre-treatment.”

Appendix B: Storm Water Pollutant Control Hydrologic Calculations and Sizing Methods

Table B.5-2. Typical Land Use Total Suspended Solids Event Mean Concentration Values

Land Use	TSS EMC ¹ , mg/L
Single Family Residential	123
Commercial	128
Industrial	125
Education (Municipal)	132
Transportation ²	78
Multi-family Residential	40
Roof Runoff ³	14
Low Traffic Areas ⁴	50
Open Space	216

Table B.5-3. Guidance for Selecting Load to Clog (LC)

BMP Configuration	Load to Clog, L _c , pounds/ft ²
Baseline: Approximately 50% vegetative cover; typical fine sand and compost blend	2
Baseline + increase vegetative cover to at least 75%	3
Baseline + include coarser sand to increase initial permeability to 20 to 30 inches/hour; control flowrate with outlet control	3
Baseline + increase vegetative cover and include more permeable media with outlet control, per above	4

References

Charters, F.J., Cochrane, T.A., and O’Sullivan, A.D., (2015). Particle Size Distribution Variance in Untreated Urban Runoff and its implication on treatment selection. *Water Research*, 85 (2015), pg. 337-345.

Davis, A.P. and McCuen, R.H., (2005). *Stormwater Management for Smart Growth*. Springer Science & Business Media, pg. 155.

Maniquiz-Redillas, M.C., Geronimo, F.K.F, and Kim, L-H. Investigation on the Effectiveness of Pretreatment in Stormwater Management Technologies. *Journal of Environmental Sciences*, 26 (2014), pg. 1824-1830.

Pitt, R. and Clark, S.E., (2010). *Evaluation of Biofiltration Media for Engineered Natural Treatment Systems*. Geosyntec Consultants and The Boeing Company.

¹ EMCs are from SBPAT datasets for San Luis Rey and San Diego River Watersheds – Arithmetic Estimates of the Lognormal Summary Statistics for San Diego, unless otherwise noted.

² EMCs are based on Los Angeles region default SBPAT datasets because of lack of available San Diego data.

³ Value represents the average first flush concentration for roof runoff (Charters et al., 2015).

⁴ Davis and McCuen (2005).

B.5.2 Sizing Biofiltration BMPs Downstream of a Storage Unit

B.5.2.1 Introduction

In scenarios in which the BMP footprint is governed based on Option 1 (Line 21 of Worksheet B.5-1) or the required volume reduction of 40 percent average annual (long-term) runoff capture for partial infiltration conditions (Line 31 of Worksheet B.5.1), the footprint of the biofiltration BMP can be optimized using the sizing calculations in this Appendix B.5.2 when there is an upstream storage unit (e.g., cistern) that can be used to regulate the flows through the biofiltration BMP.

This methodology is **not** applicable when the minimum footprint factor is governed by the alternative minimum footprint sizing factor calculated using Worksheet B.5-2 (Line 11). Biofiltration BMPs smaller than the alternative minimum footprint sizing factor are considered compact biofiltration BMPs and may be allowed at the discretion of the P&EAD and ADC if the BMP meets the requirements in Appendix F **and** Option 1 or Option 2 sizing in Worksheet B.5-1.

B.5.2.2 Sizing Calculations

Sizing calculations for the biofiltration footprint shall demonstrate that one of two equivalent performance standards is met:

- 1) Use continuous simulation and demonstrate one of the following is met based on the infiltration condition identified in Chapter B.5.4.2:
 - (a) **No infiltration condition:** The BMP or series of BMPs biofilters at least 92 percent of average annual (long-term) runoff volume. This can be demonstrated through reporting of output from the San Diego Hydrology Model, or through other continuous simulation modeling meeting the criteria in Appendix G, as acceptable to the P&EAD and ADC. The 92 percent of average annual runoff treatment corresponds to the average capture achieved by implementing a BMP with 1.5 times the DCV and a drawdown time of 36 hours (Appendix B.4.2).
 - (b) **Partial infiltration condition:** The BMP or series of BMPs biofilters at least 92 percent of average annual (long-term) runoff volume and achieves a volume reduction of at least 40 percent of average annual (long-term) runoff volume. This can be demonstrated through reporting of output from the San Diego Hydrology Model, or through other continuous simulation modeling meeting the criteria in Appendix G, as acceptable to the P&EAD and ADC.
- 2) Use the simple sizing method in Worksheet B.5-3. The applicant is also required to complete Worksheets B.5-1 and B.5-2 when the applicant elects to use Worksheet B.5-3 to optimize the biofiltration BMP footprint. Worksheet B.5-3 was developed to satisfy the following two criteria as applicable:
 - (a) Greater than 92 percent of the average annual runoff volume from the storage unit is routed to the biofiltration BMP through the low-flow orifice and the peak flow from the low-flow orifice can instantaneously be filtered through the biofiltration media. If the outlet design includes orifices at different elevations and an overflow structure, only flows from the overflow structure should be excluded from the calculation (both for

Appendix B: Storm Water Pollutant Control Hydrologic Calculations and Sizing Methods

92 percent capture and for peak flow to the biofiltration BMP that needs to be instantaneously filtered), unless the flows from other orifices also bypass the biofiltration BMP, in which case flows from the orifices that bypass should also be excluded.

- (b) The retention losses from the optimized biofiltration BMP are equal to or greater than the retention losses from the conventional biofiltration BMP. This second criterion is only applicable for partial infiltration condition.

Table B.5-4. Storage Required for Different Drawdown Times

Drawdown Time (hours)	Storage Requirement (below the overflow elevation, or below outlet elevation that bypass the biofiltration BMP)
12	0.85 DCV
24	1.25 DCV
36	1.50 DCV
48	1.80 DCV
72	2.20 DCV
96	2.60 DCV
120	2.80 DCV

For drawdown times that are outside the range of values presented in Table B.5-4, the storage unit should be designed to discharge greater than 92 percent average annual capture to the downstream biofiltration BMP.

Appendix B: Storm Water Pollutant Control Hydrologic Calculations and Sizing Methods

Worksheet B.5-3: Optimized Biofiltration BMP Footprint when Downstream of a Storage Unit

Optimized Biofiltration BMP Footprint when Downstream of a Storage Unit		Worksheet B.5-3	
1	Area draining to the storage unit and biofiltration BMP		ft ²
2	Adjusted runoff factor for drainage area (Refer to Appendix B.1 and B.2)		
3	Effective impervious area draining to the storage unit and biofiltration BMP [Line 1 x Line 2]		ft ²
4	Remaining DCV after implementing retention BMPs		ft ³
5	Infiltration rate from Worksheet D.5-1 if partial infiltration is feasible		feet/hour
6	Media Thickness [1.5 feet minimum], also add mulch layer thickness to this line for sizing calculations		feet
7	Media filtration rate to be used for sizing (0.42 ft/hr. with no outlet control; if the filtration rate is controlled by the outlet use the outlet-controlled rate)		feet/hour
8	Media retained pore storage	0.1	feet/hour
Storage Unit Requirement			
9	Drawdown time of the storage unit, minimum (from the elevation that bypasses the biofiltration BMP, overflow elevation)		hours
10	Storage required to achieve greater than 92 percent capture (see Table B.5-4)		fraction
11	Storage required in ft ³ (Line 4 x Line 10)		ft ³
12	Storage provided in the design, minimum (from the elevation that bypasses the biofiltration BMP, overflow elevation)		ft ³
13	Is Line 12 ≥ Line 11. If no increase storage provided until this criteria is met	<input type="checkbox"/> Yes <input type="checkbox"/> No	
Criteria 1: BMP Footprint Biofiltration Capacity			
14	Peak flow from the storage unit to the biofiltration BMP (using the elevation used to evaluate the percent capture)		cfs
15	Required biofiltration footprint [(3,600 x Line 14)/Line 7]		ft ²
Criteria 2: Alternative Minimum Sizing Factor (Clogging)			
16	Alternative Minimum Footprint Sizing Factor [Line 11 of Worksheet B.5-2]		Fraction
17	Required biofiltration footprint [Line 3 x Line 16]		ft ²
Criteria 3: Retention requirement [Not applicable for No Infiltration Condition]			
18	Conventional biofiltration footprint Line 28 of Worksheet B.5-1		ft ²
19	Retention Losses from the conventional footprint (36 x Line 5 + Line 6 x Line 8) x Line 18		ft ³
20	Average discharge rate from the storage unit to the biofiltration BMP		cfs
21	Depth retained in the optimized biofiltration BMP {Line 6 x Line 8} + {(Line 4)/(2400 x Line 20)} x Line 5}		feet
22	Required optimized biofiltration footprint (Line 19/Line 21)		ft ²
Optimized Biofiltration Footprint			
23	Optimized biofiltration footprint, maximum (Line 15, Line 17, Line 22)		ft ²

Notes:

Biofiltration BMP smaller than the alternative minimum footprint sizing (Line 17) is considered compact biofiltration BMP and may be allowed at the discretion of the P&EAD and ADC if the BMP meets the requirements in Appendix F and Option 1 or Option 2 sizing in Worksheet B.5-1.

B.6 Flow-Through Treatment Control BMPs (for use with Alternative Compliance)

The following methodology shall be used for selecting and sizing onsite flow-through treatment control BMPs. These BMPs are to be used only when the project is participating in an alternative compliance program. This methodology consists of three steps:

- 1) Determine the priority development project (PDP) most significant pollutants of concern (Appendix B.6.1).
- 2) Select a flow-through treatment control BMP that treats the PDP most significant pollutants of concern and meets the pollutant control BMP treatment performance standard (Appendix B.6.2).
- 3) Size the selected flow-through treatment control BMP (Appendix B.6.3).

B.6.1 PDP Most Significant Pollutants of Concern

The following steps shall be followed to identify the PDP most significant pollutants of concern:

- 1) Compile the following information for the PDP and receiving water:
 - (a) Receiving water quality (including pollutants for which receiving waters are listed as impaired under the Clean Water Act Section 303(d) List; refer to Appendix A);
 - (b) Pollutants, stressors, and/or receiving water conditions that cause or contribute to the highest priority water quality conditions identified in the WQIP (refer to Section 1.9);
 - (c) Land use type(s) proposed by the PDP and the storm water pollutants associated with the PDP land use(s) (see Table B.6–1);
 - (d) For tenant projects, the potential pollutants listed in Appendix E of the SAN SWMP.
- 2) From the list of pollutants identified in Step 1 identify the most significant PDP pollutants of concern. A PDP could have multiple most significant pollutants of concerns and shall include the highest priority water quality condition identified in the watershed WQIP and pollutants anticipated to be present onsite/generated from land use.

Appendix B: Storm Water Pollutant Control Hydrologic Calculations and Sizing Methods

Table B.6-1. Anticipated and Potential Pollutants Generated by Land Use Type

Priority Project Categories	General Pollutant Categories								
	Sediment	Nutrients	Heavy Metals	Organic Compounds	Trash & Debris	Oxygen Demanding Substances	Oil & Grease	Bacteria & Viruses	Pesticides
Commercial Development	P(1)	P(1)	X	P(2)	X	P(5)	X	P(3)	P(5)
Heavy Industry	X		X	X	X	X	X		
Automotive Repair Shops			X	X(4)(5)	X		X		
Restaurants					X	X	X	X	P(1)
Parking Lots	P(1)	P(1)	X		X	P(1)	X		P(1)
Retail Gasoline Outlets			X	X	X	X	X		
Streets, Highways & Freeways	X	P(1)	X	X(4)	X	P(5)	X	X	P(1)

Notes:

X = anticipated

P = potential

(1) A potential pollutant if landscaping exists onsite.

(2) A potential pollutant if the project includes uncovered parking areas.

(3) A potential pollutant if land use involves food or animal waste products.

(4) Including petroleum hydrocarbons.

(5) Including solvents.

B.6.2 Selection of Flow-Through Treatment Control BMPs

The following steps shall be followed to select the appropriate flow-through treatment control BMPs for the PDP:

- 1) For each PDP most significant pollutant of concern, identify the grouping using Table B.6-2. Table B.6-2 is adopted from the Model SUSMP.
- 2) Select the flow-through treatment control BMP based on the grouping of pollutants of concern that are identified to be most significant in Step 1. This section establishes the pollutant control BMP treatment performance standard to be met for each grouping of pollutants in order to meet the standards required by the MS4 permit and how an applicant can select a non-proprietary or a proprietary BMP that meets the established performance standard. The grouping of pollutants of concern are:
 - (a) Coarse sediment and trash (Appendix B.6.2.1)
 - (b) Pollutants that tend to associate with fine particles during treatment (Appendix B.6.2.2)
 - (c) Pollutants that tend to be dissolved following treatment (Appendix B.6.2.3)

Appendix B: Storm Water Pollutant Control Hydrologic Calculations and Sizing Methods

Table B.6-2: Grouping of Potential Pollutants of Concern

Pollutant	Coarse Sediment and Trash	Suspended Sediment and Particulate-bound Pollutants ¹	Soluble-form Dominated Pollutants ²
Sediment	X	X	
Nutrients			X
Heavy Metals		X	
Organic Compounds		X	
Trash & Debris	X		
Oxygen Demanding		X	
Bacteria		X	
Oil & Grease		X	
Pesticides		X	

Notes:

1. Pollutants in this category can be addressed to medium or high effectiveness by effectively removing suspended sediments and associated particulate-bound pollutants. Some soluble forms of these pollutants will exist, but treatment mechanisms to address soluble pollutants are not necessary to remove these pollutants to medium or high effectiveness.
2. Pollutants in this category are not typically addressed to a medium or high level of effectiveness with particle and particulate-bound pollutant removal alone.

One flow-through BMP can be used to satisfy the required pollutant control BMP treatment performance standard for the PDP most significant pollutants of concern. In some situations, it might be necessary to implement multiple flow-through BMPs to satisfy the pollutant control BMP treatment performance standards. For example, for a PDP that has trash, nutrients, and bacteria as the most significant pollutants of concern, if a vegetated filter strip is selected as a flow-through BMP, then it is anticipated to meet the performance standard in Appendices B.6.2.2 and B.6.2.3 but would need a trash removal BMP to meet the pollutant control BMP treatment performance standard in Appendix B.6.2.1 upstream of the vegetated filter strip. This could be achieved by fitting the inlets and/or outlets with racks or screens on to address trash.

B.6.2.1 Coarse Sediment and Trash

If coarse sediment and/or trash and debris are identified as a pollutant of concern for the PDP, then BMPs must be selected to capture and remove these pollutants from runoff. The BMPs described in this section can be effective in removing coarse sediment and/or trash. These devices must be sized to treat the flow rate estimated using Worksheet B.6-1. The applicant can select only BMPs that have high or medium effectiveness.

Trash Racks and Screens [Coarse Sediment: Low effectiveness; Trash: Medium to High effectiveness] are simple devices that can prevent large debris and trash from entering storm drain infrastructure and/or ensure that trash and debris are retained with downstream BMPs. Trash racks and screens can be installed at inlets to the storm drain system, at the inflow line to a BMP, and/or on the outflow structure from the BMP. Trash racks and screens are commercially available in many sizes and configurations or can be designed and fabricated to meet specific project needs.

Appendix B: Storm Water Pollutant Control Hydrologic Calculations and Sizing Methods

Hydrodynamic Separation Devices [Coarse Sediment: Medium to High effectiveness; Trash: Medium to High effectiveness] are devices that remove coarse sediment, trash, and other debris from incoming flows through a combination of screening, settlement, and centrifugal forces. The design of hydrodynamic devices varies widely; more specific information can be found by contacting individual vendors. A list of hydrodynamic separator products approved by the Washington State Technology Acceptance Protocol-Ecology protocol can be found at:

<http://www.ecy.wa.gov/programs/wq/stormwater/newtech/technologies.html>.

Systems should be rated for “pretreatment” with a General Use Level Designation or provide results of field-scale testing indicating an equivalent level of performance.

Catch Basin Insert Baskets [Coarse Sediment: Low effectiveness; Trash: Medium effectiveness, if appropriately maintained] are manufactured filters, fabrics, or screens that are placed in inlets to remove trash and debris. The shape and configuration of catch basin inserts vary based on inlet type and configuration. Inserts are prone to clogging and bypass if large trash items are accumulated and therefore require frequent observation and maintenance to remain effective. Systems with a screen size small enough to retain coarse sediment tend to clog rapidly and should be avoided.

Other Manufactured Particle Filtration Devices [Coarse Sediment: Medium to High effectiveness; Trash: Medium to High effectiveness] include a range of products such as cartridge filters, bag filters, and other configurations that address medium to coarse particles. Systems should be rated for “pretreatment” with a General Use Level Designation under the Technology Acceptance Protocol-Ecology program or provide results of field-scale testing indicating an equivalent level of performance.

Note: any BMP that achieves medium or high performance for suspended solids (see Section B.6.2.2) is also considered to address coarse sediments. However, some BMPs that address suspended solids do not retain trash (e.g., swales and detention basins). These types of BMPs could be fitted with racks or screens on inlets or outlets to address trash.

BMP Selection for Pretreatment:

Devices that address both coarse sediment and trash can be used as pretreatment devices for other BMPs, such as infiltration BMPs. However, it is recommended that BMPs that meet the performance standard in Appendix B.6.2.2 be used. A device with a “pretreatment” rating and General Use Level Designation under Technology Acceptance Protocol-Ecology is required for pretreatment upstream of infiltration basins and underground galleries. Pretreatment may also be provided as presettling basins or forebays as part of a pollutant control BMP instead of implementing a specific pretreatment device for systems where maintenance access to the facility surface is possible (to address clogging), expected sediment load is not high, and appropriate factors of safety are included in design.

Appendix B: Storm Water Pollutant Control Hydrologic Calculations and Sizing Methods

B.6.2.2 Suspended Sediment and Particulate-Bound Pollutants

Performance Standard

The pollutant treatment performance standard is shown in Table B.6-3. This performance standard is consistent with the Washington State Technology Acceptance Protocol-Ecology Basic Treatment Level and is also met by technologies receiving Phosphorus Treatment or Enhanced Treatment certification. This standard is based on pollutant removal performance for TSS. Systems that provide effective TSS treatment also typically address trash, debris, and particulate-bound pollutants and can serve as pre-treatment for offsite mitigation projects or for onsite infiltration BMPs.

Table B.6-3. Performance Standard for Flow-Through Treatment Control

Influent Range	Criteria
20 – 100 mg/L TSS	Effluent goal \leq 20 mg/L TSS
100 – 200 mg/L TSS	\geq 80% TSS removal
>200 mg/L TSS	> 80% TSS removal, effluent not to exceed 100 mg/L TSS

Selecting Non-Proprietary BMPs

Table B.6-4 identifies the categories of non-proprietary BMPs that are considered to meet the pollutant treatment performance standard if designed to contemporary design standards¹. BMP types with a “high” ranking should be considered before those with an “medium” ranking. Statistical analysis by category from the International Stormwater BMP Database (also presented in Table B.6-4) indicates that each of these BMP types (as a categorical group) meets or nearly meets the performance standard. The International Stormwater BMP Database includes historical and contemporary BMP studies; contemporary BMP designs in these categories are anticipated to meet or exceed this standard on average.

¹ Contemporary design standards refer to design standards that are reasonably consistent with the current state of practice and are based on desired outcomes that are reasonably consistent with the context of the MS4 Permit and this Manual. For example, a detention basin that is designed solely to mitigate peak flow rates would not be considered a contemporary water quality BMP design because it is not consistent with the goal of water quality improvement. Current state-of-the-practice recognizes that a drawdown time of 24 to 72 hours is typically needed to promote settling. For practical purposes, design standards can be considered “contemporary” if they have been published within the last 10 years, preferably in California or Washington State, and are specifically intended for storm water quality management.

Appendix B: Storm Water Pollutant Control Hydrologic Calculations and Sizing Methods

Table B.6-4. Flow-Through Treatment Control BMPs Meeting Performance Standard

List of Acceptable Flow-Through Treatment Control BMPs	Statistical Analysis of International Stormwater BMP Database				Evaluation of Conformance to Performance Standard		
	Count In/Out	TSS Mean Influent, mg/L	TSS Mean Effluent ¹ , mg/L	Average Category Volume Reduct.	Volume-Adjusted Effluent Conc ² , mg/L	Volume-Adjusted Removal Efficiency ²	Level of Attainment of Performance Standard (with rationale)
Vegetated Filter Strip	361/282	69	31	38%	19	72%	Medium, effluent < 20 mg/L after volume adjustment
Vegetated Swale	399/346	45	33	48%	17	61%	Medium, effluent < 20 mg/L after volume adjustment
Detention Basin	321/346	125	42	33%	28	77%	Medium, percent removal near 80% after volume adjustment
Sand Filter/Media Bed Filter	381/358	95	19	NA ³	19	80%	High, effluent and % removal meet criteria without adjustment
Lined Porous Pavement ⁴	356/220	229	46	NA ^{3,4}	46	80%	High, % removal meets criteria without adjustment
Wet Pond	923/933	119	31	NA ³	31	74%	Medium, percent removal near 80%

Source: 2014 BMP Performance Summaries and Statistical Appendices; 2010 Volume Performance Summary; available at: www.bmpdatabase.org

Notes:

1. A statistically significant difference between influent and effluent was detected at a p value of 0.05 for all categories.
2. Estimates were adjusted to account for category-average volume reduction.
3. Not applicable because these BMPs are not designed for volume reduction and are anticipated to have very small incidental volume reduction.
4. The category presented in this table represents a lined system for flow-through treatment purposes. Porous pavement for retention purposes is an infiltration BMP, not a flow-through BMP. This table should not be consulted for porous pavement for infiltration.

Selecting Proprietary BMPs

Proprietary BMPs can be used if the BMP meets each of the following conditions:

- 1) **The proposed BMP meets the performance standard in Appendix B.6.2.2 as certified through third-party, field scale evaluation.** An active General Use Level Designation for Basic Treatment, Phosphorus Treatment or Enhanced Treatment under the Washington State Technology Acceptance Protocol-Ecology program is the preferred method of demonstrating that the performance standard is met. The list of certified technologies is updated as new technologies are approved (link below). Technologies with Pilot Use Level Designation and Conditional Use Level Designations are not acceptable. Refer to: <http://www.ecy.wa.gov/programs/wq/stormwater/newtech/technologies.html>. Alternatively, other field scale verification of 80 percent TSS capture, such as through Technology Acceptance Reciprocity Partnership or New Jersey Corporation for Advance

Appendix B: Storm Water Pollutant Control Hydrologic Calculations and Sizing Methods

Testing may be acceptable. A list of field-scale verified technologies under Technology Acceptance Reciprocity Partnership Tier II and New Jersey Corporation for Advance Testing can be accessed at: <http://www.njcat.org/verification-process/technology-verification-database.html> (refer to field verified technologies only).

- 2) **The proposed BMP is designed and maintained in a manner consistent with its performance certifications (see explanation below).** The applicant must demonstrate conclusively that the proposed application of the BMP is consistent with the basis of its certification/verification. Certifications or verifications issued by the Washington Technology Acceptance Protocol-Ecology program and the Technology Acceptance Reciprocity Partnership or New Jersey Corporation for Advance Testing programs are typically accompanied by a set of guidelines regarding appropriate design and maintenance conditions that would be consistent with the certification/verification. It is common for these approvals to specify the specific model of BMP, design capacity for given unit sizes, type of media that is the basis for approval, and/or other parameters.
- 3) **The proposed BMP is acceptable at the discretion of the P&EAD and ADC.** The applicant may be required to provide additional studies and/or required to meet additional design criteria beyond the scope of this document to demonstrate that these criteria are met. In determining the acceptability of a proprietary flow-through treatment control BMP, the P&EAD and ADC should consider, as applicable, (1) the data submitted; (2) representativeness of the data submitted; (3) consistency of the BMP performance claims with pollutant control objectives; certainty of the BMP performance claims; (4) for projects within tenant areas and/or capital projects: maintenance requirements, cost of maintenance activities, relevant previous local experience with operation and maintenance of the BMP type, ability to continue to operate the system in event that the vending company is no longer operating as a business; and (5) other relevant factors. If a proposed BMP is not accepted by the P&EAD or ADC, a written explanation/reason will be provided to the applicant.

B.6.2.3 Soluble-form Dominated Pollutants (Nutrients)

If nutrients are identified as a most significant pollutant of concern for the PDP, then BMPs must be selected to meet the performance standard described in Appendix B.6.2.2 **and** must be selected to provide medium or high level of effectiveness for nutrient treatment as described in this section. The most common nutrient of concern in the San Diego region is nitrogen, therefore total nitrogen (TN) was used as the primary indicator of nutrient performance in storm water BMPs.

Selection of BMPs to address nutrients consists of two steps:

- 1) Determine whether nutrients can be addressed via source control BMPs as described in Appendix E and Chapter 4. After applying source controls, if there are no remaining source areas for soluble nutrients, then this pollutant can be removed from the list of pollutants of concern for the purpose of selecting flow-through treatment control BMPs. Particulate nutrients will be addressed by the performance standard in Appendix B.6.2.2.
- 2) If soluble nutrients cannot be fully addressed with source controls, then select a flow-through treatment control BMP that meets the performance criteria in Table B.6-5 or select from the nutrient-specific menu of treatment control BMPs in Table B.6-6.

Appendix B: Storm Water Pollutant Control Hydrologic Calculations and Sizing Methods

- (a) The performance standard for nitrogen removal (Table B.6-5) has been developed based on evaluation of the relative performance of available categories of non-proprietary BMPs.
- (b) For proprietary BMPs, submit third-party performance data indicating that the criteria in Table B.6-5 are met. The applicant may be required to provide additional studies and/or required to meet additional design criteria beyond the scope of this document to demonstrate that these criteria are met. In determining the acceptability of a proprietary flow-through treatment control BMP, the P&EAD and ADC should consider, as applicable, (1) the data submitted; (2) representativeness of the data submitted; (3) consistency of the BMP performance claims with pollutant control objectives; certainty of the BMP performance claims; (4) for projects within tenant areas and/or capital projects: maintenance requirements, cost of maintenance activities, relevant previous local experience with operation and maintenance of the BMP type, ability to continue to operate the system in event that the vending company is no longer operating as a business; and (5) other relevant factors. If a proposed BMP is not accepted by the P&EAD or ADC, a written explanation/reason will be provided to the applicant.

Table B.6-5. Performance Standard for Flow-Through Treatment Control BMPs for Nutrient Treatment

Basis	Criteria
Treatment Basis	Comparison of mean influent and effluent indicates significant concentration reduction of TN approximately 40 percent or higher based on studies with representative influent concentrations
Combined Treatment and Volume Reduction Basis	Combination of concentration reduction and volume reduction yields TN mass removal of approximately 40 percent or higher based on studies with representative influent concentrations

Appendix B: Storm Water Pollutant Control Hydrologic Calculations and Sizing Methods

Table B.6-6. Flow-Through Treatment Control BMPs Meeting Nutrient Treatment Performance Standard

List of Acceptable Flow-Through Treatment Control BMPs for Nutrients	Statistical Analysis of International Stormwater BMP Database				Evaluation of Conformance to Performance Standard		
	Count In/Out	TN Mean Influent, mg/L	TN Mean Effluent ¹ , mg/L	Average Category Volume Reduct.	Volume-Adjusted Effluent Conc ² , mg/L	Volume-Adjusted Removal Efficiency ²	Level of Attainment of Performance Standard (with rationale)
Vegetated Filter Strip	138/ 122	1.53	1.37	38%	0.85	44%	Medium, if designed to include volume reduction processes
Detention Basin	90/ 89	2.34	2.01	33%	1.35	42%	Medium, if designed to include volume reduction processes
Wet Pond	397/ 425	2.12	1.33	NA	1.33	37%	Medium, best concentration reduction among BMP categories, but limited volume reduction

Source: 2014 BMP Performance Summaries and Statistical Appendices; 2010 Volume Performance Summary; available at: www.bmpdatabase.org

Notes:

1. A statistically significant difference between influent and effluent was detected at a p value of 0.05 for all categories included.
2. Estimates were adjusted to account for category-average volume reduction.

B.6.3 Sizing Flow-Through Treatment Control BMPs:

Flow-through treatment control BMPs shall be sized to filter or treat the maximum flow rate of runoff produced from a rainfall intensity of 0.2 inch of rainfall per hour for each hour of every storm event. The required flow-through treatment rate should be adjusted for the portion of the DCV already retained or biofiltered onsite as described in Worksheet B.6-1. The following hydrologic method shall be used to calculate the flow rate to be filtered or treated:

$$Q = C \times i \times A$$

where:

Q = Design flow rate in ft³ per second

C = Runoff factor, area-weighted estimate using Table B.1-1.

i = Rainfall intensity of 0.2 inch/hour.

A = Tributary area (acres) that includes the total area draining to the BMP, including any offsite or onsite areas that comingle with project runoff and drain to the BMP. Refer to Section 3.3.3 of the Manual for additional guidance. Street projects consult Section 1.4.3 of the Manual.

Appendix B: Storm Water Pollutant Control Hydrologic Calculations and Sizing Methods

Worksheet B.6-1. Flow-Through Design Flows

Flow-through Design Flows		Worksheet B.6-1		
1	DCV	DCV		ft ³
2	DCV retained	DCV _{retained}		ft ³
3	DCV biofiltered	DCV _{biofiltered}		ft ³
4	DCV requiring flow-through (Line 1 – Line 2 – 0.67*Line 3)	DCV _{flow-through}		ft ³
5	Adjustment factor (Line 4/Line 1)*	AF=		unitless
6	Design rainfall intensity	i=	0.20	inches/ hour
7	Area tributary to BMP (s)	A=		acres
8	Area-weighted runoff factor (estimate using Appendix B.2)	C=		unitless
9	Calculate Flow Rate = AF x (C x i x A)	Q=		cfs

Notes:

1. Adjustment factor shall be estimated considering only retention and biofiltration BMPs located upstream of flow-through BMPs. That is, if the flow-through BMP is upstream of the project's retention and biofiltration BMPs, then the flow-through BMP shall be sized using an adjustment factor of 1.
2. Volume based (e.g., dry extended detention basin) flow-through treatment control BMPs shall be sized to the volume in Line 4 and flow-based (e.g., vegetated swales) BMPs shall be sized to flow rate in Line 9. Sand filter and media filter can be designed either by volume in Line 4 or flow rate in Line 9.
3. Proprietary BMPs, if used, shall provide certified treatment capacity equal to or greater than the calculated flow rate in Line 9; certified treatment capacity per unit shall be consistent with third party certifications.

Appendix

C

AUTHORITY BMP DESIGN MANUAL

Geotechnical and Groundwater Investigation Requirements

February 2022

Appendix C Geotechnical and Groundwater Investigation Requirements

C.1 Purpose and Phasing

Feasibility of storm water infiltration is dependent on the geotechnical and groundwater conditions at the project site.

This appendix provides guidelines for performing and reporting feasibility analysis for infiltration with respect to geotechnical and groundwater conditions. It provides framework for feasibility analysis at two phases of project development:

- **Planning Phase:** Simpler methods for conducting preliminary screening for feasibility/infeasibility, and
- **Design Phase:** When infiltration is considered potentially feasible, more rigorous analysis is needed to confirm feasibility and to develop design considerations and mitigation measures if required

Planning Phase. At this stage of the project, information about the site may be limited, the proposed design features may be conceptual, and there may be an opportunity to adjust project plans to incorporate infiltration into the project layout as it is developed. At this phase, project geotechnical engineers are typically responsible for conducting explorations of geologic conditions, performing preliminary analyses, and identifying particular aspects of design that require more detailed investigation at later phases. As part of this process, the role of a planning-level infiltration feasibility assessment is to help planners reach early tentative conclusions regarding where infiltration is likely feasible, possibly feasible if done carefully, or clearly infeasible. This determination can help guide the design process by influencing project layout, selecting infiltration BMPs, and identifying whether more detailed studies are necessary. The goal of the planning and feasibility phase is to identify potential geotechnical and groundwater impacts and to determine the impacts that may be considered fatal flaws and the impacts that may be possible to mitigate with design features. Determination of acceptable risks and/or mitigation measures may involve discussions with adjacent landowners and/or utility operators, as well as coordination with other projects under planning or design in the project vicinity. Early involvement of potentially impacted parties is critical to avoid late-stage design changes and schedule delays and to reduce potential future liabilities.

Design Phase. During this phase, potential geotechnical and groundwater impacts must be fully considered and evaluated, and mitigation measures should be incorporated in the BMP design, as appropriate. Mitigation measures refer to design features or assumptions intended to reduce risks associated with storm water infiltration. Although rules of thumb may be useful, if applied carefully, for the planning level phase, the analyses conducted in the detailed design phase require the involvement of a geotechnical professional familiar with the local conditions. One of the first steps in the design phase should be determination whether additional field and/or laboratory investigations

Appendix C: Geotechnical and Groundwater Investigation Requirements

are required (e.g., borings, test pits, laboratory or field testing) to further assess the geotechnical impacts of storm water infiltration. Because the designs of infiltration systems are highly dependent on the subsurface conditions, coordination with the storm water design team may be beneficial to limit duplicative efforts and costs.

Worksheet C.4-1 is provided to document infiltration feasibility screening. This worksheet is divided into two parts. Part 1 “Full Infiltration Feasibility Screening Criteria” is used to determine whether the full design volume can be infiltrated onsite, and Part 2 “Partial Infiltration versus No Infiltration Screening Criteria” is used to determine whether any amount of volume can be infiltrated.

Note that it is not necessary to investigate each and every criterion in the worksheet, a single “no” answer in Part 1 and Part 2 controls the feasibility and desirability. If all the answers in Part 1 are “yes,” then it is not required to complete Part 2. The same worksheet could be used to document both planning-level categorization and design-level categorization. Note that planning-level categorization, are typically based on initial site assessment results; therefore, it is not necessarily conclusive. Categorizations should be confirmed or revised, as necessary, based on more detailed design-level investigation and analysis during BMP design.

C.2 Geotechnical Feasibility Criteria

This section is divided into seven factors that should be considered, as applicable, while assessing the feasibility and desirability of infiltration related to geotechnical conditions. Note that during the planning phase, if one or more of these factors precludes infiltration as an approach, it is not necessary to assess every other factor. However, if proposing infiltration BMPs, then every applicable factor in this section must be addressed.

C.2.1 Soil and Geologic Conditions

Site soils and geologic conditions influence the rate at which water can physically enter the soils. Site assessment approaches for soil and geologic conditions may consist of:

- Review of soil survey maps
- Review of available reports on local geology to identify relevant features, such as depth to bedrock, rock type, lithology, faults, and hydrostratigraphic or confining units
- Review of previous geotechnical investigations of the area
- Site-specific geotechnical and/or geologic investigations (e.g., borings, infiltration tests)

Geologic investigations should also seek to provide an assessment of whether soil infiltration properties are likely to be uniform or variable across the project site. Appendix D provides guidance on determining infiltration rates for planning and design phase.

C.2.2 Settlement and Volume Change

Settlement and volume change limits the amount of infiltration that can be allowed without resulting in adverse impacts that cannot be mitigated. Upon considering the impacts of an infiltration design, the designer must identify areas where soil settlement or heave is likely and whether these conditions would be unfavorable to existing or proposed features. Settlement refers to the condition when soils decrease in volume, and heave refers to expansion of soils or increase in volume.

Several different mechanisms can induce volume change because of infiltration that the professional must be aware of and consider while completing the feasibility screening including:

- Hydro collapse and calcareous soils;
- Expansive soils;
- Frost heave;
- Consolidation; and
- Liquefaction.

Appendix C: Geotechnical and Groundwater Investigation Requirements

C.2.3 Slope Stability

Infiltration of water has the potential to result in an increased risk of slope failure of nearby slopes. This should be assessed as part of both the feasibility and design stages of a project. The City of San Diego Guidelines for Geotechnical Reports states that slope steeper than 25 percent are generally not feasible for use of infiltration BMPs. The County of San Diego LID Handbook recommends a 50-foot setback from steep or sensitive slopes. In general, this consideration will not apply to Authority projects as there are no significant slopes at SAN.

C.2.4 Utility Considerations

Utilities are either public or private infrastructure components that include underground pipelines and vaults (e.g., potable water, sewer, storm water, gas pipelines), underground wires/conduit (e.g., telephone, cable, electrical) and above ground wiring and associated structures (e.g., electrical distribution and transmission lines). Utility considerations are typically within the purview of a geotechnical site assessment and should be considered in assessing the feasibility of storm water infiltration. Infiltration has the potential to damage subsurface utilities and/or underground utilities may pose geotechnical hazards in themselves when infiltrated water is introduced. Impacts related to storm water infiltration in the vicinity of underground utilities are not likely to cause a fatal flaw in the design, but the designer must be aware of the potential cost impacts on the design during the planning stage.

Utility setbacks should be determined on a project-specific basis, with the approval of the P&EAD and ADC.

C.2.5 Groundwater Mounding

Storm water infiltration and recharge to the underlying groundwater table may create a groundwater mound beneath the infiltration facility. The height and shape of the mound depend on the infiltration system design, the recharge rate, and the hydrogeologic conditions at the site, especially the horizontal hydraulic conductivity and the saturated thickness. Elevated groundwater levels can lead to a number of problems, including flooding and damage to structures and utilities through buoyancy and moisture intrusion, increased inflow and infiltration into municipal sanitary sewer systems, and flow of water through existing utility trenches, including sewers, potentially leading to formation of sinkholes (Gobel et al. 2004). Mounding shall be considered by the geotechnical professional while performing the infiltration feasibility screening.

C.2.6 Retaining Walls and Foundations

Development projects may include retaining walls or foundations in proximity to proposed infiltration BMPs. These structures are designed to withstand the forces of the earth they are retaining and other surface loading conditions such as nearby structures. Foundations include shallow foundations (spread and strip footings, mats) and deep foundations (piles, piers) and are designed to support overburden and design loads. All types of retaining walls and foundations can be impacted by increased water

Appendix C: Geotechnical and Groundwater Investigation Requirements

infiltration into the subsurface as a result of potential increases in lateral pressures and potential reductions in soil strength. The geotechnical professional should consider these factors while performing the infiltration feasibility screening.

C.2.7 Other Factors

While completing the feasibility screening, other factors determined by the geotechnical professional to influence the feasibility and desirability of infiltration related to geotechnical conditions shall also be considered.

C.3 Groundwater Quality and Water Balance

Feasibility Criteria

This section is divided into eight factors that should be considered, to the extent applicable, while assessing the feasibility and desirability of infiltration related to groundwater quality and water balance. Note that, during the planning phase, if one or more of these factors preclude infiltration as an approach, it is not necessary to assess every other factor. However, if proposing infiltration BMPs, then every applicable factor in this section must be addressed.

C.3.1 Soil and Groundwater Contamination

Infiltration shall be avoided in areas with:

- Physical and chemical characteristics (e.g., appropriate cation exchange capacity, organic content, clay content and infiltration rate) that are not adequate for proper infiltration durations and treatment of runoff for the protection of groundwater beneficial uses.
- Groundwater contamination and/or soil pollution, if infiltration could contribute to the movement or dispersion of soil or groundwater contamination or adversely affect ongoing cleanup efforts, either onsite or downgradient of the project.

If infiltration is under consideration for one of the above conditions, a site-specific analysis should be conducted to determine where infiltration-based BMPs can be used without adverse impacts.

C.3.2 Separation to Seasonal High Groundwater

The depth to seasonally high groundwater tables (normal high depth during the wet season) beneath the base of any infiltration BMP must be greater than 10 feet for infiltration BMPs to be allowed. The depth to groundwater requirement can be reduced from 10 feet at the discretion of the approval agency if the underlying groundwater basin does not support beneficial uses and the groundwater quality is maintained at the proposed depth. Estimation of depth to seasonally high groundwater levels can be based on well level measurements or redoximorphic methods. For sites with complex groundwater tables, long-term studies may be needed to understand how groundwater levels change in wet and dry years.

Note that groundwater at SAN does not support beneficial uses (Water Quality Control Plan for the San Diego Basin, 1994/1995 with amendments effective prior to February 16, 2016). As such, the vertical distance from the base of any infiltration BMP to the seasonal high groundwater mark at the SAN may be less than 10 feet, provided that groundwater quality is maintained, and the remaining restrictions of Section 3.3 are met.

C.3.3 Wellhead Protection

Wellheads, both natural and man-made, are water resources that may potentially be adversely impacted by storm water infiltration through the introduction of contaminants or alteration in water supply and levels. It is recommended that the locations of wells and springs be identified early in the design process and site design be developed to avoid infiltration in the vicinity of these resources. Infiltration BMPs must be located a minimum of 100 feet horizontally from any water supply well. Although no wells are located within SAN, the locations of wells in neighboring jurisdictions (i.e., within the City of San Diego and Port of San Diego jurisdictions) should be considered.

C.3.4 Contamination Risks from Land Use Activities

Concentration of storm water pollutants in runoff is highly dependent on the land uses and activities in the area tributary to an infiltration BMP. Likewise, the potential for groundwater contamination due to the infiltration BMP is a function of pollutant abundance, concentration of pollutants in soluble forms, and the mobility of the pollutant in the subsurface soils. Hence infiltration BMPs must not be used for areas of industrial or light industrial activity, and other high threat to water quality land uses and activities, unless source control BMPs to prevent exposure of high-threat activities are implemented, or runoff from such activities is first treated or filtered to remove pollutants prior to infiltration.

Source control BMPs (as outlined in Appendix B of the SWMP) should be used to reduce concentrations of priority pollutants, including copper and zinc, from industrial areas prior to infiltration.

C.3.5 Consultation with Applicable Groundwater Agencies

Infiltration activities should be coordinated with the applicable groundwater management agency, such as groundwater providers and/or resource protection agencies, to ensure that groundwater quality is protected. It is recommended that coordination be initiated as early as possible during the planning process to determine whether specific site assessment activities apply or whether these agencies have data available that may support the planning and design process.

C.3.6 Water Balance Impacts on Stream Flow

Use of infiltration systems to reduce surface water discharge volumes may result in additional volume of deeper infiltration compared to natural conditions, which may result in impacts to receiving channels associated with change in dry weather flow regimes. A relatively simple survey of hydrogeologic data (piezometer measurements, boring logs, regional groundwater maps) and downstream receiving water characteristics is generally adequate to determine whether there is potential for impacts and whether a more rigorous assessment is needed.

Where water balance conditions appear to be sensitive to development impacts and there is an elevated risk of impacts, a computational analysis may be warranted to evaluate the feasibility/desirability of infiltration. Such an analysis should account for precipitation, runoff, irrigation inputs, soil moisture

Appendix C: Geotechnical and Groundwater Investigation Requirements

retention, evapotranspiration, baseflow, and change in groundwater recharge on a long term basis. Because water balance calculations are sensitive to the timing of precipitation versus evapotranspiration, it is most appropriate to utilize a continuous model simulation rather than basing calculations on average annual or monthly normal conditions.

C.3.7 Downstream Water Rights

Although water rights cases are not believed to be common, there may be cases in which infiltration of water from area that was previously allowed to drain freely to downstream water bodies would not be legal from a water rights perspective. Site-specific evaluation of water rights laws should be conducted if this is believed to be a potential issue in the project location.

C.3.8 Other Factors

While completing the feasibility screening, other factors determined by the geotechnical professional to influence the feasibility and desirability of infiltration related to groundwater quality and water balance shall also be considered.

C.4 Geotechnical and Groundwater Investigation Report Requirements

The geotechnical and groundwater investigation report(s) addressing onsite storm water infiltration shall include the following elements, as applicable. These reports may need to be completed by multiple professional disciplines, depending on the issues that need be addressed for a given site. It may also be necessary to prepare separate report(s) at the planning phase and design phase of a project if the methods and timing of analyses differ.

C.4.1 Site Evaluation

Site evaluation shall identify the following:

- Areas of contaminated soil or contaminated groundwater within the site;
- “Brown fields” adjacent to the site;
- Mapped soil or fill type(s);
- Historic high groundwater level;
- Slopes steeper than 25 percent (not applicable at SAN); and
- Location of septic systems (and expansion area), or underground storage tanks, or permitted gray water systems within 100 feet of a proposed infiltration/ percolation BMP.

C.4.2 Field Investigation

Where the site evaluation indicates potential feasibility for onsite storm water infiltration BMPs, the following field investigations will be necessary to demonstrate suitability and to provide design recommendations.

C.4.2.1 Subsurface Exploration

Subsurface exploration and testing for storm water infiltration BMPs shall include the following:

- Conduct a minimum of two exploratory excavations within 50 feet of each proposed storm water infiltration BMP. The excavations shall extend at least 10 feet below the lowest elevation of the base of the proposed infiltration BMP.
- Log soils in detail with emphasis on describing the soil profile.
- Identify low permeability or impermeable materials.
- Indicate any evidence of soil contamination.

Appendix C: Geotechnical and Groundwater Investigation Requirements

C.4.2.2 Material Testing and Infiltration/Percolation Testing

Various material testing and in situ infiltration/percolation testing methods and guidance for appropriate factor of safety are discussed in detail in Appendix D. Infiltration testing methods described in Appendix D include surface and shallow excavation methods and deeper subsurface tests.

C.4.2.3 Evaluation of Depth to Groundwater

An evaluation of the depth to groundwater is required to confirm the feasibility of infiltration. Infiltration BMPs may not be feasible in high groundwater conditions (within 10 feet of the base of infiltration/ percolation BMP) unless an exemption is granted by the P&EAD or ADC. The vertical distance from the base of any infiltration BMP to the seasonal high groundwater mark at the SAN may be less than 10 feet, provided groundwater quality is maintained and the remaining restrictions of Section 3.3 are met.

C.4.3 Reporting Requirements by Geotechnical Engineer

The geotechnical and groundwater investigation report shall address the following key elements, and where appropriate, mitigation recommendations shall be provided.

- Identify areas of the project site where infiltration is likely to be feasible and provide justifications for selection of those areas based on soil types, slopes, proximity to existing features, etc. Include completed and signed Worksheet C.4-1.
- Investigate, evaluate, and estimate the vertical infiltration rates and capacities in accordance with the guidance provided in Appendix D, which describes infiltration testing and appropriate factor of safety to be applied for infiltration testing results. The site may be broken into sub-basins, each of which has different infiltration rates or capacities.
- Describe the infiltration/percolation test results and correlation with published infiltration/percolation rates based on soil parameters or classification. Recommend providing design infiltration/percolation rate(s) at the sub-basins. Use Worksheet D.5-1.
- Investigate the subsurface geological conditions and geotechnical conditions that would affect infiltration or migration of water toward structures, slopes, utilities, or other features. Describe the anticipated flow path of infiltrated water. Indicate whether the water will flow into pavement sections, utility trench bedding, wall drains, foundation drains, or other permeable improvements.
- Investigate depth to groundwater and the nature of the groundwater. Include an estimate of the high seasonal groundwater elevations.
- Evaluate proposed use of the site (industrial use, commercial use, etc.), soil, and groundwater data and provide a concluding opinion whether proposed storm water infiltration could cause adverse impacts on groundwater quality. If it does cause impacts, evaluate whether the impacts could be reasonably mitigated or not.

Appendix C: Geotechnical and Groundwater Investigation Requirements

- Estimate the maximum allowable infiltration rates and volumes that could occur at the site that would avoid damage to existing and proposed structures, utilities, slopes, or other features. In addition, the report must indicate whether the recommended infiltration rate is appropriate based on the conditions exposed during construction.
- Provide a concluding opinion regarding whether the proposed onsite storm water infiltration/percolation BMP will result in soil piping, daylight water seepage, slope instability, or ground settlement.
- Recommend measures to substantially mitigate or avoid any potentially detrimental effects of the storm water infiltration BMPs or associated soil response on existing or proposed improvements or structures, utilities, slopes, or other features within and adjacent to the site. For example, minimize soil compaction.
- Provide guidance for the selection and location of infiltration BMPs, including the minimum separations between such infiltration BMPs and structures, streets, utilities, manufactured and existing slopes, engineered fills, utilities or other features. Include guidance for measures that could be used to reduce the minimum separations or to mitigate the potential impacts of infiltration BMPs.
- Provide a concluding opinion whether or not proposed infiltration BMPs are in conformance with the following design criteria:
 - Runoff will undergo pretreatment such as sedimentation or filtration prior to infiltration;
 - Pollution prevention and source control BMPs are implemented at a level appropriate to protect groundwater quality for areas draining to infiltration BMPs;
 - The vertical distance from the base of the infiltration BMPs to the seasonal high groundwater mark is greater than 10 feet. As the groundwater basin at SAN does not support beneficial uses, this vertical distance may be reduced provided the groundwater quality is maintained and the remaining restrictions of Section 3.3 of the Manual are met;
 - The soil through which infiltration is to occur has physical and chemical characteristics (e.g., appropriate cation exchange capacity, organic content, clay content, and infiltration rate) which are adequate for proper infiltration durations and treatment of runoff for the protection of groundwater beneficial uses; and
 - Infiltration BMPs are not used for areas of industrial or light industrial activity, unless source control BMPs to prevent exposure of high threat activities are implemented, or runoff from such activities is first treated or filtered to remove copper, zinc, and other pollutants of concern prior to infiltration.

C.4.4 Reporting Requirements by the Project Design Engineer

Project design engineer has the following responsibilities:

- Complete criteria 4 and 8 in Worksheet C.4-1.

Appendix C: Geotechnical and Groundwater Investigation Requirements

Worksheet C.4-1: Categorization of Infiltration Feasibility Condition

Categorization of Infiltration Feasibility Condition		Worksheet C.4-1	
<p><u>Part 1 - Full Infiltration Feasibility Screening Criteria</u></p> <p>Would infiltration of the full design volume be feasible from a physical perspective without any undesirable consequences that cannot be reasonably mitigated?</p>			
Criteria	Screening Question	Yes	No
1	<p>Is the estimated reliable infiltration rate below proposed facility locations greater than 0.5 inch per hour? The response to this Screening Question shall be based on a comprehensive evaluation of the factors presented in Appendix C.2 and Appendix D.</p>		
<p>Provide basis:</p> <p>Summarize findings of studies; provide reference to studies, calculations, maps, data sources, etc. Provide narrative discussion of study/data source applicability.</p>			
2	<p>Can infiltration greater than 0.5 inch per hour be allowed without increasing risk of geotechnical hazards (slope stability, groundwater mounding, utilities, or other factors) that cannot be mitigated to an acceptable level? The response to this Screening Question shall be based on a comprehensive evaluation of the factors presented in Appendix C.2.</p>		
<p>Provide basis:</p> <p>Summarize findings of studies; provide reference to studies, calculations, maps, data sources, etc. Provide narrative discussion of study/data source applicability.</p>			

Appendix C: Geotechnical and Groundwater Investigation Requirements

Worksheet C.4-1 Page 2 of 4			
Criteria	Screening Question	Yes	No
3	<p>Can infiltration greater than 0.5 inch per hour be allowed without increasing risk of groundwater contamination (shallow water table, storm water pollutants or other factors) that cannot be mitigated to an acceptable level? The response to this Screening Question shall be based on a comprehensive evaluation of the factors presented in Appendix C.3.</p>		
<p>Provide basis:</p> <p>Summarize findings of studies; provide reference to studies, calculations, maps, data sources, etc. Provide narrative discussion of study/data source applicability.</p>			
4	<p>Can infiltration greater than 0.5 inch per hour be allowed without causing potential water balance issues such as change of seasonality of ephemeral streams or increased discharge of contaminated groundwater to surface waters? The response to this Screening Question shall be based on a comprehensive evaluation of the factors presented in Appendix C.3.</p>		
<p>Provide basis:</p> <p>Summarize findings of studies; provide reference to studies, calculations, maps, data sources, etc. Provide narrative discussion of study/data source applicability.</p>			
Part 1 Result*	<p>If all answers to rows 1–4 are “Yes,” a full infiltration design is potentially feasible. The feasibility screening category is Full Infiltration</p> <p>If any answer from row 1–4 is “No,” infiltration may be possible to some extent but would not generally be feasible or desirable to achieve a “full infiltration” design. Proceed to Part 2</p>		

*To be completed using gathered site information and best professional judgment considering the definition of MEP in the MS4 Permit. Additional testing and/or studies may be required by P&EAD or ADC to substantiate findings.

Appendix C: Geotechnical and Groundwater Investigation Requirements

Worksheet C.4-1 Page 3 of 4			
<p>Part 2 – Partial Infiltration vs. No Infiltration Feasibility Screening Criteria</p> <p>Would infiltration of water in any appreciable amount be physically feasible without any negative consequences that cannot be reasonably mitigated?</p>			
Criteria	Screening Question	Yes	No
5	<p>Do soil and geologic conditions allow for infiltration in any appreciable rate or volume? The response to this Screening Question shall be based on a comprehensive evaluation of the factors presented in Appendix C.2 and Appendix D.</p>		
<p>Provide basis:</p> <p>Summarize findings of studies; provide reference to studies, calculations, maps, data sources, etc. Provide narrative discussion of study/data source applicability and why it was not feasible to mitigate low infiltration rates.</p>			
6	<p>Can Infiltration in any appreciable quantity be allowed without increasing risk of geotechnical hazards (slope stability, groundwater mounding, utilities, or other factors) that cannot be mitigated to an acceptable level? The response to this Screening Question shall be based on a comprehensive evaluation of the factors presented in Appendix C.2.</p>		
<p>Provide basis:</p> <p>Summarize findings of studies; provide reference to studies, calculations, maps, data sources, etc. Provide narrative discussion of study/data source applicability and why it was not feasible to mitigate low infiltration rates.</p>			

Appendix C: Geotechnical and Groundwater Investigation Requirements

Worksheet C.4-1 Page 4 of 4			
Criteria	Screening Question	Yes	No
7	<p>Can Infiltration in any appreciable quantity be allowed without posing significant risk for groundwater related concerns (shallow water table, storm water pollutants or other factors)? The response to this Screening Question shall be based on a comprehensive evaluation of the factors presented in Appendix C.3.</p>		
<p>Provide basis:</p> <p>Summarize findings of studies; provide reference to studies, calculations, maps, data sources, etc. Provide narrative discussion of study/data source applicability and why it was not feasible to mitigate low infiltration rates.</p>			
8	<p>Can infiltration be allowed without violating downstream water rights? The response to this Screening Question shall be based on a comprehensive evaluation of the factors presented in Appendix C.3.</p>		
<p>Provide basis:</p> <p>Summarize findings of studies; provide reference to studies, calculations, maps, data sources, etc. Provide narrative discussion of study/data source applicability and why it was not feasible to mitigate low infiltration rates.</p>			
Part 2 Result*	<p>If all answers from row 5–8 are yes, then partial infiltration design is potentially feasible. The feasibility screening category is Partial Infiltration.</p> <p>If any answer from row 5–8 is no, then infiltration of any volume is considered to be infeasible within the drainage area. The feasibility screening category is No Infiltration.</p>		

*To be completed using gathered site information and best professional judgment considering the definition of MEP in the MS4 Permit. Additional testing and/or studies may be required by Agency/Jurisdictions to substantiate findings

Appendix C: Geotechnical and Groundwater Investigation Requirements

C.5 Feasibility Screening Exhibits

Table C.5-1 lists the feasibility screening exhibits that were generated using readily available GIS data sets to assist the project applicant to screen the project site for feasibility.

Table C.5-1: Feasibility Screening Exhibits

Figures	Layer	Intent/Rationale	Data Sources
C.1 Soils	Hydrologic Soil Group – A, B, C, D	Hydrologic Soil Group will aid in determining areas of potential infiltration	SanGIS http://www.sangis.org/
	Hydric Soils	Hydric soils will indicate layers of intermittent saturation that may function like a D soil and should be avoided for infiltration	USDA Web Soil Survey. Hydric soils (ratings of 100) were classified as hydric. http://websoilsurvey.sc.egov.usda.gov/App/HomePage.htm
C.2: Slopes and Geologic Hazards	Slopes >25%	BMPs are hard to construct on slopes >25% and can potentially cause slope instability (not applicable at SAN	SanGIS http://www.sangis.org/
	Liquefaction Potential	BMPs (particularly infiltration BMPs) must not be sited in areas with high potential for liquefaction or landslides to minimize earthquake/landslide risks	SanGIS http://www.sangis.org/
	Landslide Potential		SanGIS Geologic Hazards layer. Subset of polygons with hazard codes related to landslides was selected. These data are limited to the City of San Diego Boundary. http://www.sangis.org/
C.3: Groundwater Table Elevations	Groundwater Depths	Infiltration BMPs will need to be sited in areas with adequate distance (>10 feet) from the groundwater table, unless groundwater quality is maintained	GeoTracker. Data downloaded for San Diego County from 2014 and 2013. In cases where there were multiple measurements made at the same well, the average was taken over that year. http://geotracker.waterboards.ca.gov/data_download_by_county.asp
C.4: Contaminated Sites	Contaminated soils and/or groundwater sites	Infiltration must be limited in areas of contaminated soil/groundwater	GeoTracker. Data downloaded for San Diego County and limited to active cleanup sites http://geotracker.waterboards.ca.gov/

Appendix C: Geotechnical and Groundwater Investigation Requirements

This page intentionally left blank

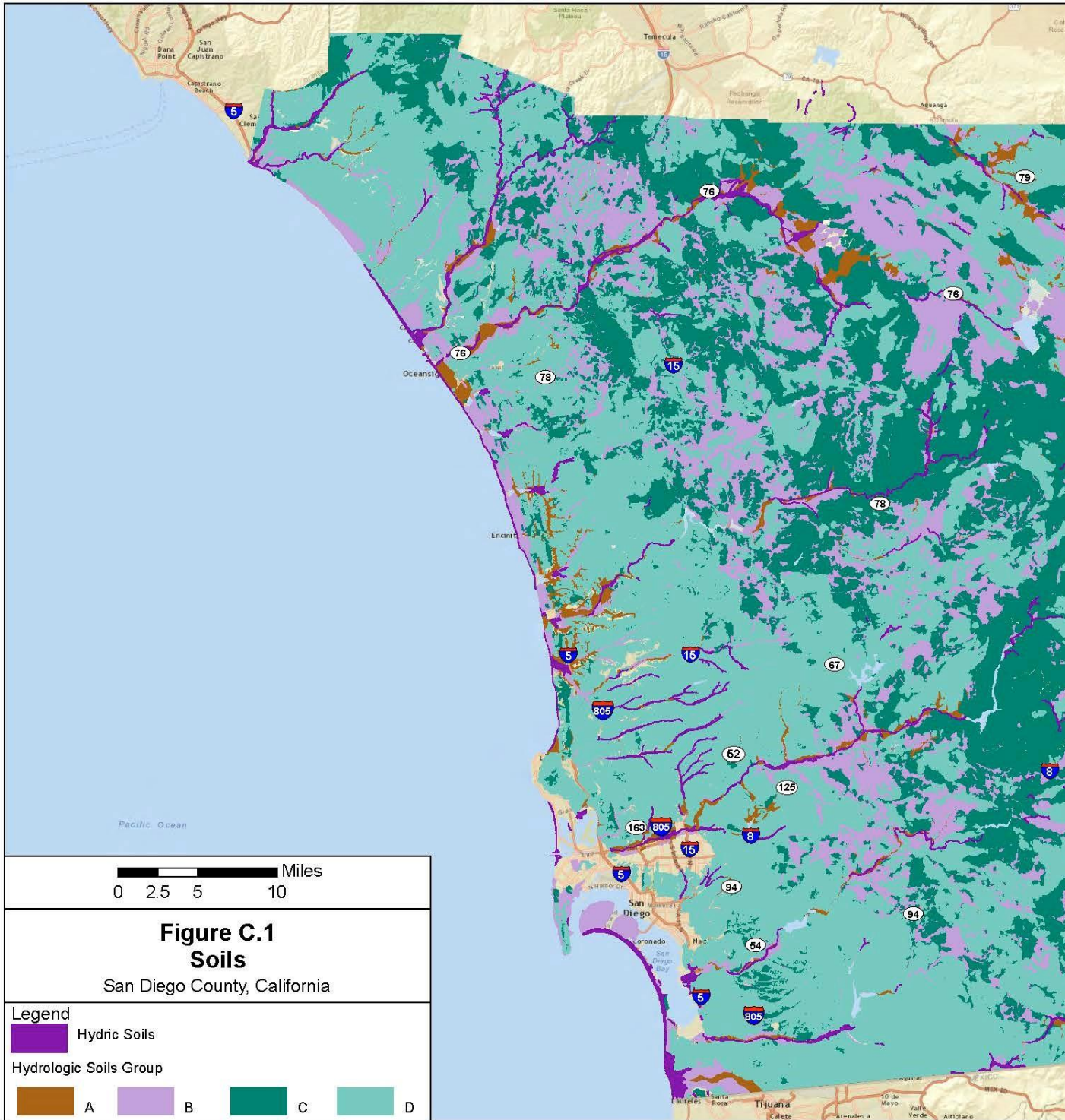

Figure C.1. Soils

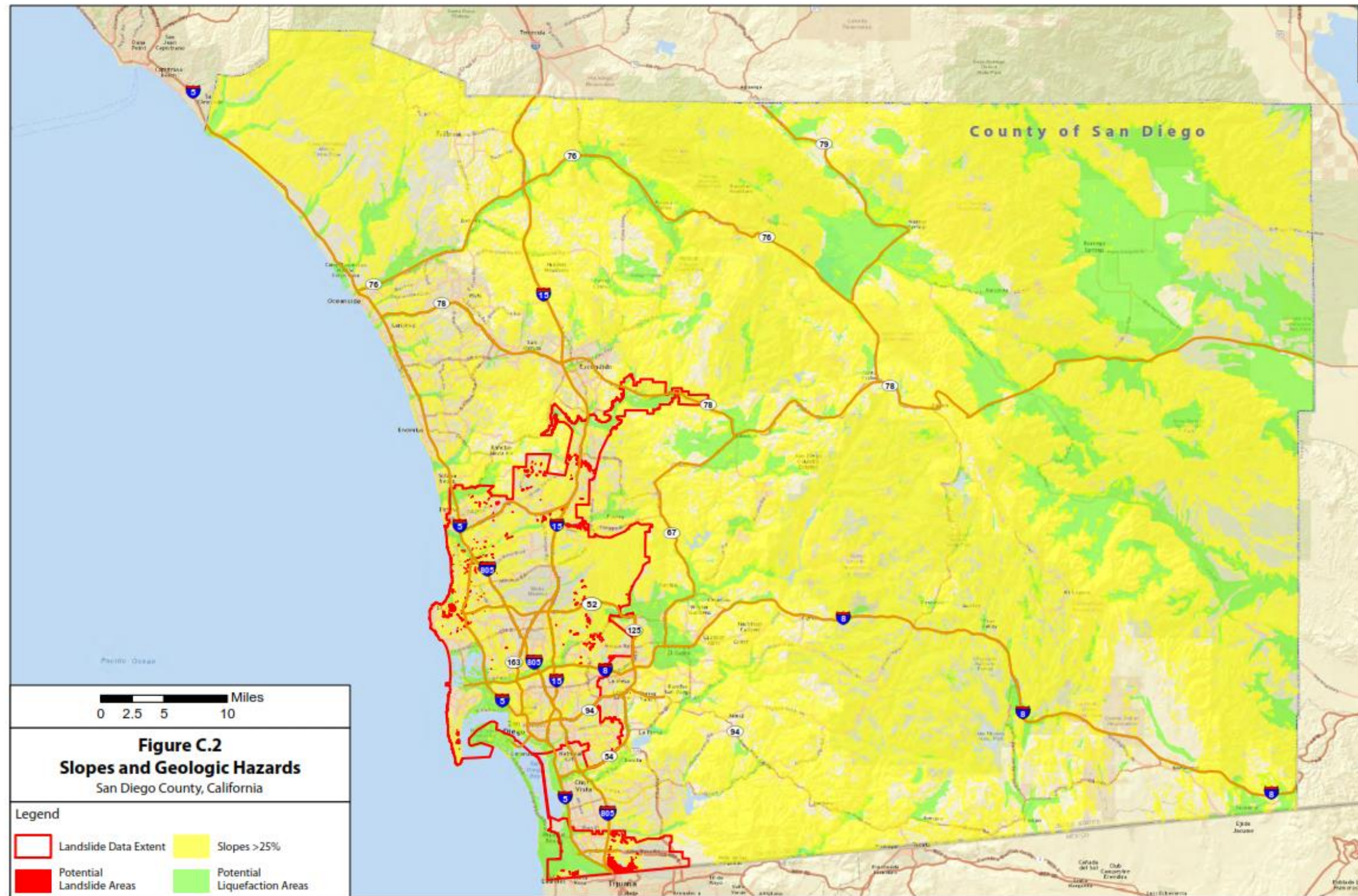

Figure C.2. Slopes and Geologic Hazards

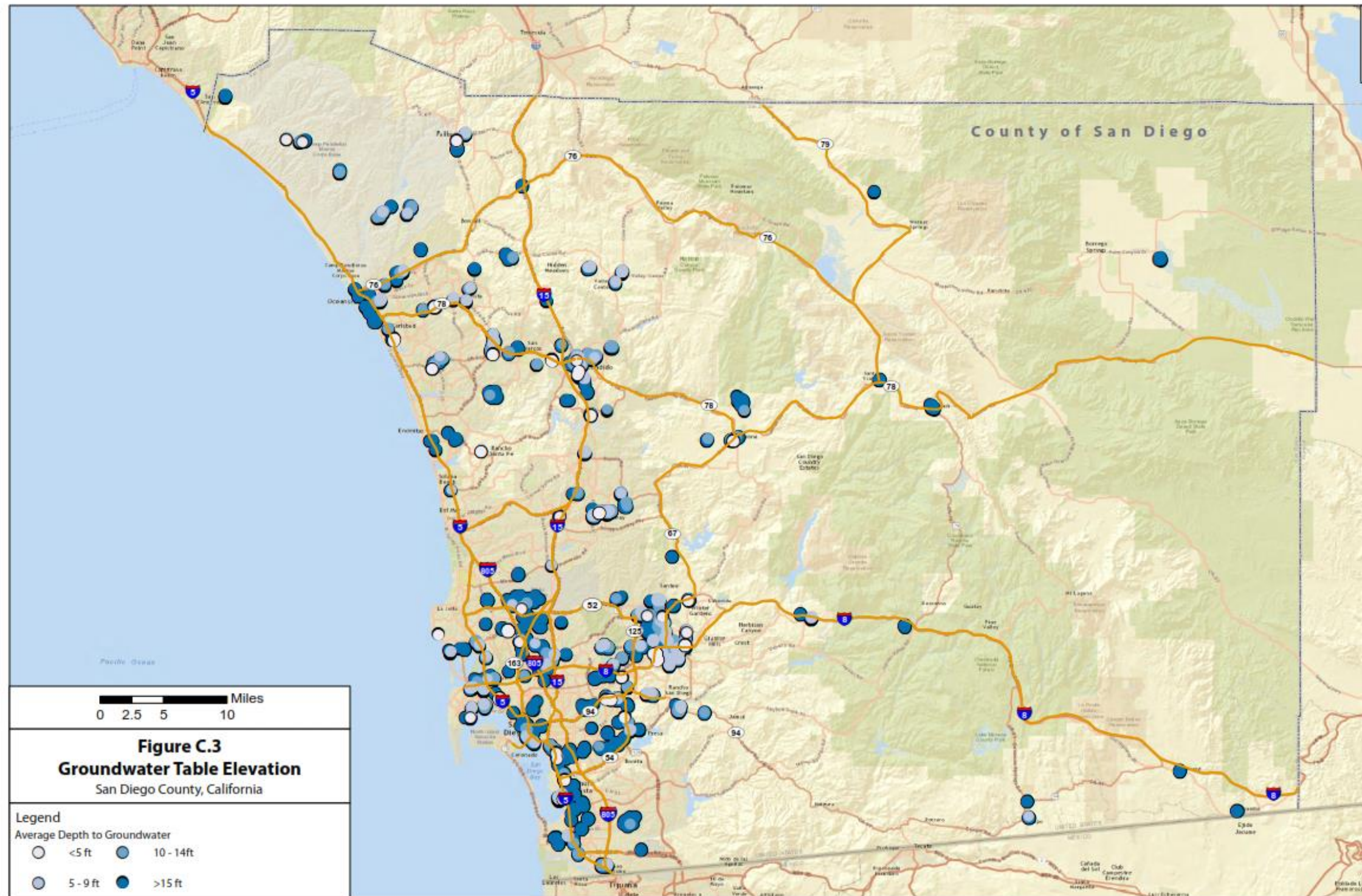

Figure C.13. Groundwater Table Elevation

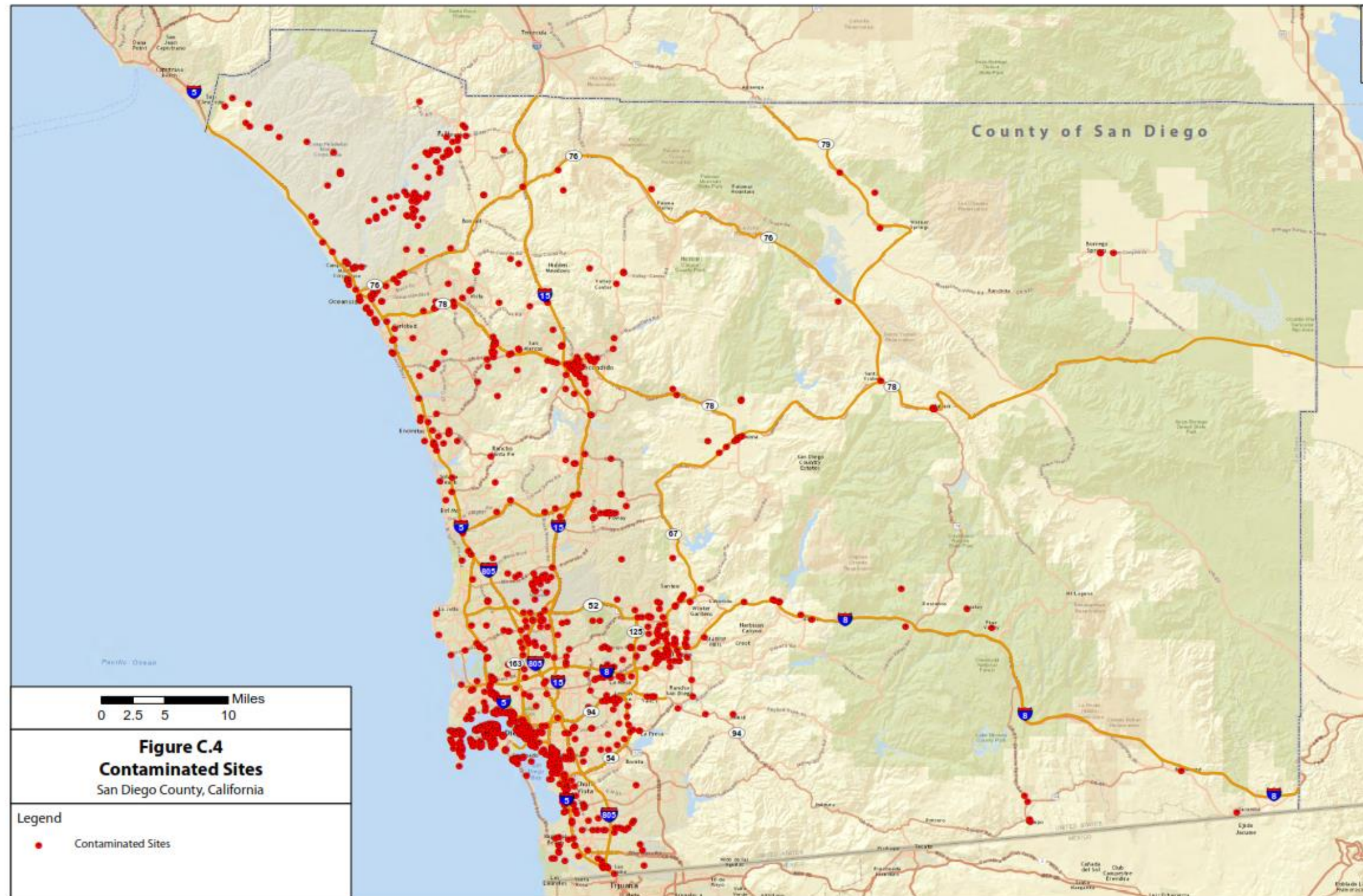

Figure C.1. Contaminated Sites

Appendix

D

AUTHORITY BMP DESIGN MANUAL

**Approved Infiltration Rate
Assessment Methods for
Selection of Storm Water BMPs**

February 2022

Appendix D Approved Infiltration Rate Assessment Methods for Selection and Design of Storm Water BMPs

D.1 Introduction

Characterization of potential infiltration rates is a critical step in evaluating the degree to which infiltration can be used to reduce storm water runoff volume. This appendix is intended to provide guidance to help answer the following questions:

1. *How and where does infiltration testing fit into the project development process?*

Section D.2 discusses the role of infiltration testing in different stage of project development and how to plan a phased investigation approach.

2. *What infiltration rate assessment methods are acceptable?*

Section D.3 describes the infiltration rate assessment methods that are acceptable.

3. *What factors should be considered in selecting the most appropriate testing method for a project?*

Section D.4 provides guidance on site-specific considerations that influence which assessment methods are most appropriate.

4. *How should factors of safety be selected and applied to, for BMP selection and design?*

Section D.5 provides guidance for selecting a safety factor.

Note that this appendix does not consider other feasibility criteria that may make infiltration infeasible, such as groundwater contamination and geotechnical considerations (these are covered in Appendix C). In general, infiltration testing should be conducted only after other feasibility criteria specified in this Manual have been evaluated and cleared.

D.2 Role of Infiltration Testing in Different Stages of Project Development

In the process of planning and designing infiltration facilities, there are a number of ways that infiltration testing or estimation factors into project development, as summarized in Table D.2-1. As part of selecting infiltration testing methods, the geotechnical engineer shall select methods that are applicable to the phase of the project and the associated burden of proof.

Appendix D: Approved Infiltration Rate Assessment Methods

Table D.2-1. Role of Infiltration Testing

Project Phase	Key Questions/Burden of Proof	General Assessment Strategies
Site Planning Phase	<ul style="list-style-type: none"> • Where within the project area is infiltration potentially feasible? • What volume reduction approaches are potentially suitable for my project? 	<ul style="list-style-type: none"> • Use existing data and maps to the extent possible • Use less expensive methods to allow a broader area to be investigated more rapidly • Reach tentative conclusions that are subject to confirmation/refinement at the design phase
BMP Design Phase	<ul style="list-style-type: none"> • What infiltration rates should be used to design infiltration and biofiltration facilities? • What factor of safety should be applied? 	<ul style="list-style-type: none"> • Use more rigorous testing methods at specific BMP locations • Support or modify preliminary feasibility findings • Estimate design infiltration rates with appropriate factors of safety

D.3 Guidance for Selecting Infiltration Testing Methods

The geotechnical engineer shall select appropriate testing methods for the site conditions, subject to the engineer’s discretion and approval of the P&EAD and ADC, that are adequate to meet the burden of proof that is applicable at each phase of the project design (see Table D.3-1):

- At the planning phase, testing/evaluation method must be selected to provide a reliable estimate of the locations where infiltration is feasible and allow a reasonably confident determination of infiltration feasibility to support the selection between full infiltration, partial infiltration, and no infiltration BMPs.
- At the design phase, the testing method must be selected to provide a reliable infiltration rate to be used in design. The degree of certainty provided by the selected test should be considered.

Table D.3-1 provides a matrix comparison of these methods. Sections D.3.1 through D.3.3 provide a summary of each method. This appendix is not intended to be an exhaustive reference on infiltration testing at this time. It does not attempt to discuss every method for testing, nor is it intended to provide step-by-step procedures for each method. The user is directed to supplemental resources (referenced in this appendix) or other appropriate references for more specific information. **Alternative testing methods are allowed with appropriate rationales, subject to the discretion of the ADC and P&EAD.**

To select an infiltration testing method, it is important to understand how each test is applied and what specific physical properties the test is designed to measure. Infiltration testing methods vary considerably in these regards. For example, a borehole percolation test is conducted by drilling a borehole, filling a portion of the hole with water, and monitoring the rate of fall of the water. This

Appendix D: Approved Infiltration Rate Assessment Methods

test directly measures the three-dimensional flux of water into the walls and bottom of the borehole. An approximate correction is applied to indirectly estimate the vertical hydraulic conductivity from the results of the borehole test. In contrast, a double-ring infiltrometer test is conducted from the ground surface and is intended to provide a direct estimate of vertical (one-dimensional) infiltration rate at this point. Both of these methods are applicable under different conditions.

Table D.3-1. Comparison of Infiltration Rate Estimation and Testing Methods

Test	Suitability at Planning Level Screening Phase	Suitability at BMP Design Phase
NRCS Soil Survey Maps	Yes, but mapped soil types must be confirmed with site observations. Regional soil maps are known to contain inaccuracies at the scale of typical development sites.	No, unless a strong correlation is developed between soil types and infiltration rates in the direct vicinity of the site and an elevated factor of safety is used.
Grain Size Analysis	Not preferred. Should only be used if a strong correlation has been developed between grain size analysis and measured infiltration rates testing results of site soils.	No
Cone Penetrometer Testing	Not preferred. Should only be used if a strong correlation has been developed between CPT results and measured infiltration rates testing results of site soils.	No
Simple Open Pit Test	Yes	Yes, with appropriate correction for infiltration into side walls and elevated factor of safety.
Open Pit Falling Head Test	Yes	Yes, with appropriate correction for infiltration into side walls and elevated factor of safety.
Double Ring Infiltrometer Test (ASTM 3385)	Yes	Yes
Single Ring Infiltrometer Test	Yes	Yes
Large-scale Pilot Infiltration Test	Yes, but generally cost prohibitive and too water-intensive for preliminary screening of a large area.	Yes, but should consider relatively large water demand associated with this test.
Smaller-scale Pilot Infiltration Test	Yes	Yes
Well Permeameter Method (USBR 7300-89)	Yes, reliability of this test can be improved by obtaining a continuous core where tests are conducted.	Yes, in areas of proposed cut where other tests are not possible; a continuous boring log should be recorded and used to interpret test; should be confirmed with a more direct measurement following excavation.
Borehole Percolation Tests (various methods)	Yes, reliability of this test can be improved by obtaining a continuous core where tests are conducted.	Yes, in areas of proposed cut where other tests are not possible; a continuous boring log should be recorded and used to interpret test; should be confirmed with a more direct measurement following excavation.

Appendix D: Approved Infiltration Rate Assessment Methods

Table D.3-1. Comparison of Infiltration Rate Estimation and Testing Methods (continued)

Test	Suitability at Planning Level Screening Phase	Suitability at BMP Design Phase
Laboratory Permeability Tests (e.g., ASTM D2434)	Yes, only suitable for evaluating potential infiltration rates in proposed fill areas. For sites with proposed cut, it is preferred to do a borehole percolation test at the proposed grade instead of analyzing samples in the lab. A combination of both tests may improve reliability.	No. However, may be part of a line of evidence for estimating the design infiltration of partial infiltration BMPs constructed in future compacted fill.

D.3.1 Desktop Approaches and Data Correlation Methods

This section reviews common methods used to evaluate infiltration characteristics based on desktop-available information, such as geographic information system (GIS) data. This section also introduces methods for estimating infiltration properties via correlations with other measurements.

D.3.1.1 NRCS Soil Survey Maps

NRCS Soil Survey maps (<http://websoilsurvey.nrcs.usda.gov/app/HomePage.htm>) can be used to estimate preliminary feasibility conditions, specifically by mapping hydrologic soil groups, soil texture classes, and presence of hydric soils relative to the site layout. For feasibility determinations, mapped conditions must be supplemented with available data from the site (e.g., soil borings, observed soil textures, biological indicators), especially at SAN, because the underlying soils are generally undifferentiated bay deposits and hydraulic fill material from San Diego Bay. The presence of D soils, if confirmed by available data, provides a reasonable basis to determine that full infiltration is not feasible for a given DMA.

D.3.1.2 Grain Size Analysis Testing and Correlations to Infiltration Rate

Hydraulic conductivity can be estimated indirectly from correlations with soil grain-size distributions. While this method is approximate, correlations have been relatively well established for some soil conditions. One of the most commonly used correlations between grain size parameters and hydraulic conductivity is the Hazen (1892, 1911) empirical formula (Philips and Kitch, 2011), but a variety of others have been developed. Correlations must be developed based on testing of site-specific soils.

D.3.1.3 Cone Penetrometer Testing and Correlations to Infiltration Rate

Hydraulic conductivity can also be estimated indirectly from cone penetrometer testing (CPT). A cone penetrometer test involves advancing a small probe into the soil and measuring the relative resistance encountered by the probe as it is advanced. The signal returned from this test can be interpreted to yield estimated soil types and the location of key transitions between soil layers. If this method is used, correlations must be developed based on testing of site-specific soils.

D.3.2 Surface and Shallow Excavation Methods

This section describes tests that are conducted at the ground surface or within shallow excavations close to the ground surface. These tests are generally applicable for cases where the bottom of the infiltration system will be near the existing ground surface. They can also be conducted to confirm the results of borehole methods after excavation/site grading has been completed.

D.3.2.1 Simple Open Pit Test

The Simple Open Pit Test is most appropriate for planning level screening of infiltration feasibility. Although it is similar to Open Pit Falling Head tests used for establishing a design infiltration rate (see below), the Simple Open Pit Test is less rigorous and is generally conducted to a lower standard of care. This test can be conducted by a nonprofessional as part of planning level screening phase.

The Simple Open Pit Test is a falling head test in which a hole at least 2 feet in diameter is filled with water to a level of 6 inches above the bottom. Water level is checked and recorded regularly until either an hour has passed, or the entire volume has infiltrated. The test is repeated two more times in succession, and the rate at which the water level falls in the third test is used as the infiltration rate.

This test has the advantage of being inexpensive to conduct. Yet it is believed to be fairly reliable for screening as the dimensions of the test are similar, proportionally, to the dimensions of a typical BMP. The key limitations of this test are that it measures a relatively small area, does not necessarily result in a precise measurement, and may not be uniformly implemented.

Source: City of Portland, 2008. Storm water Management Manual

D.3.2.2 Open Pit Falling Head Test

This test is similar to the Simple Open Pit Test, but covers a larger footprint, includes more specific instructions, returns more precise measurements, and generally should be overseen by a geotechnical professional. Nonetheless, it remains a relatively simple test.

To perform this test, a hole is excavated at least 2 feet wide by 4 feet long (larger is preferred) and to a depth of at least 12 inches. The bottom of the hole should be approximately at the depth of the proposed infiltrating surface of the BMP. The hole is pre-soaked by filling it with water at least 1 foot above the soil to be tested and leaving it at least 4 hours (or overnight if clays are present). After pre-soaking, the hole is refilled to a depth of 12 inches and allow it to drain for one hour (2 hours for slower soils), measuring the rate at which the water level drops. The test is then repeated until successive trials yield a result with less than 10 percent change.

In comparison with a double-ring infiltrometer, this test has the advantage of measuring infiltration over a larger area and better resembles the dimensionality of a typical small-scale BMP. Because it includes both vertical and lateral infiltration, it should be adjusted to estimate design rates for larger scale BMPs.

D.3.2.3 Double Ring Infiltrometer Test (ASTM 3385)

The Double Ring Infiltrometer was originally developed to estimate the saturated hydraulic conductivity of low-permeability materials, such as clay liners for ponds, but has seen significant use in storm water applications. The most recent revision of this method from 2009 is known as ASTM 3385-09. The testing apparatus is designed with concentric rings that form an inner ring and an annulus between the inner and outer rings. Infiltration from the annulus between the two rings is intended to saturate the soil outside of the inner ring such that infiltration from the inner ring is restricted primarily to the vertical direction.

To conduct this test, both the center ring and annulus between the rings are filled with water. There is no pre-wetting of the soil in this test. However, a constant head of 1 to 6 inches is maintained for 6 hours, or until a constant flow rate is established. Both the inner flow rate and annular flow rate are recorded, but if they are different, the inner flow rate should be used. There are a variety of approaches that are used to maintain a constant head on the system, including use of a Mariotte tube, constant level float valves, or manual observation and filling. This test must be conducted at the elevation of the proposed infiltrating surface; therefore, application of this test is limited in cases where the infiltration surface is a significant distance below existing grade at the time of testing.

This test is generally considered to provide a direct estimate of vertical infiltration rate for the specific point tested and is highly replicable. However, given the small diameter of the inner ring (standard diameter is 12 inches, but it can be larger), this test only measures infiltration rate in a small area. Additionally, given the small quantity of water used in this test compared to larger scale tests, this test may be biased high in cases where the long-term infiltration rate is governed by groundwater mounding and the rate at which mounding dissipates (i.e., the capacity of the infiltration receptor). Finally, the added effort and cost of isolating vertical infiltration rate may not necessarily be warranted because BMPs typically have a lateral component of infiltration as well. Therefore, although this method has the advantages of being technical rigorous and well standardized, it should not necessarily be assumed to be the most representative test for estimating full-scale infiltration rates. Source: ASTM (2009).

D.3.2.4 Single Ring Infiltrometer Test

The single ring infiltrometer test is not a standardized ASTM test, however it is a relatively well-controlled test and shares many similarities with the ASTM standard double ring infiltrometer test (ASTM 3385-09). This test is a constant head test using a large ring (preferably greater than 40 inches in diameter) usually driven 12 inches into the soil. Water is ponded above the surface. The rate of water addition is recorded, and infiltration rate is determined after the flow rate has stabilized. Water can be added either manually or automatically.

The single ring used in this test tends to be larger than the inner ring used in the double ring test. Driving the ring into the ground limits lateral infiltration; however, some lateral infiltration is generally considered to occur. Experience in Riverside County (California) has shown that this test gives results that are close to full-scale infiltration facilities. The primary advantages of this test are that it is relatively simple to conduct and has a larger footprint (compared with the double-ring method) and restricts horizontal infiltration and is more standardized (compared with open pit methods). However,

Appendix D: Approved Infiltration Rate Assessment Methods

it is still a relatively small-scale test and can only be reasonably conducted near the existing ground surface.

D.3.2.5 Large-scale Pilot Infiltration Test

As its name implies, this test is closer in scale to a full-scale infiltration facility. This test was developed by Washington State Department of Ecology specifically for storm water applications.

To perform this test, a test pit is excavated with a horizontal surface area of roughly 100 square feet (ft²) to a depth that allows 3 to 4 feet of ponding above the expected bottom of the infiltration facility. Water is continually pumped into the system to maintain a constant water level (between 3 and 4 feet about the bottom of the pit, but not more than the estimated water depth in the proposed facility), and the flow rate is recorded. The test is continued until the flow rate stabilizes. Infiltration rate is calculated by dividing the flow rate by the surface area of the pit. Similar to other open pit test, this test is known to result in a slight bias high because infiltration also moves laterally through the walls of the pit during the test. Washington State Department of Ecology requires a correction factor of 0.75 (factor of safety of 1.33) be applied to results.

This test has the advantage of being more resistant to bias from localized soil variability and being more similar to the dimensionality and scale of full scale BMPs. It is also more likely to detect long-term declines in infiltration rates associated with groundwater mounding. As such, it remains the preferred test for establishing design infiltration rates in Western Washington (Washington State Department of Ecology, 2012). In a comparative evaluation of test methods, this method was found to provide a more reliable estimate of full-scale infiltration rate than double ring infiltrometer and borehole percolation tests (Philips and Kitch, 2011).

The difficulty encountered in this method is that it requires a larger area be excavated than the other methods, and this in turn requires larger equipment for excavation and a greater supply of water. However, this method should be strongly considered when less information is known about spatial variability of soils and/or a higher degree of certainty in estimated infiltration rates is desired.

Source: Washington State Department of Ecology, 2012.

D.3.2.6 Smaller-scale Pilot Infiltration Test

The smaller-scale PIT is conducted similarly to the large-scale PIT but involves a smaller excavation, ranging from 20 to 32 ft² instead of 100 ft² for the large-scale PIT, with similar depths. The primary advantage of this test compared to the full-scale PIT is that it requires less excavation volume and less water. It may be more suitable for small-scale distributed infiltration controls where the need to conduct a greater number of tests outweighs the accuracy that must be obtained in each test, and where groundwater mounding is not as likely to be an issue. Washington State Department of Ecology establishes a correction factor of 0.5 (factor of safety of 2.0) for this test in comparison to 0.75 (factor of safety of 1.33) for the large-scale PIT to account for a greater fraction of water infiltrating through the walls of the excavation and lower degree of certainty related to spatial variability of soils.

D.3.3 Deeper Subsurface Tests

D.3.3.1 Well Permeameter Method (USBR 7300-89)

Well permeameter methods were originally developed for purposes of assessing aquifer permeability and associated yield of drinking water wells. This family of tests is most applicable in situations in which infiltration facilities will be placed substantially below existing grade, which limits the use of surface testing methods.

In general, this test involves drilling a 6 inch to 8-inch test well to the depth of interest and maintaining a constant head until a constant flow rate has been achieved. Water level is maintained with down-hole floats. The Porchet method or the nomographs provided in the USBR Drainage Manual (United States Department of the Interior, Bureau of Reclamation, 1993) are used to convert the measured rate of percolation to an estimate of vertical hydraulic conductivity. A smaller diameter boring may be adequate; however, this then requires a different correction factor to account for the increased variability expected.

Although these tests have applicability in screening level analysis, considerable uncertainty is introduced in the step of converting direct percolation measurements to estimates of vertical infiltration. Additionally, this testing method is prone to yielding erroneous results cases where the vertical horizon of the test intersects with minor lenses of sandy soils that allow water to dissipate laterally at a much greater rate than would be expected in a full-scale facility. To improve the interpretation of this test method, a continuous bore log should be inspected to determine whether thin lenses of material may be biasing results at the strata where testing is conducted. Consult USBR procedure 7300-89 for more details.

Source: United States Department of the Interior, Bureau of Reclamation, 1990, 1993

D.3.3.2 Borehole Percolation Tests (various methods)

Borehole percolation tests were originally developed as empirical tests to estimate the capacity of onsite sewage disposal systems (septic system leach fields) but have more recently been adopted into use for evaluating storm water infiltration. Similar to the well permeameter method, borehole percolation methods primarily measure lateral infiltration into the walls of the boring and are designed for situations in which infiltration facilities will be placed well below current grade. The percolation rate obtained in this test should be converted to an infiltration rate using a technique such as the Porchet method.

This test is generally implemented similarly to the USBR Well Permeameter Method. Per the Riverside County Borehole Percolation method, a hole is bored to a depth at least 5 times the borehole radius. The hole is presoaked for 24 hours (or at least 2 hours if sandy soils with no clay). The hole is filled to approximately the anticipated top of the proposed infiltration basin. Rates of fall are measured for six hours, refilling each half hour (or 10 minutes for sand). Tests are generally repeated until consistent results are obtained.

The same limitations described for the well permeameter method apply to borehole percolation tests, and their applicability is generally limited to initial screening. To improve the interpretation of this test

Appendix D: Approved Infiltration Rate Assessment Methods

method, a continuous soil core can be extracted from the hole and below the test depth, following testing, to determine whether thin lenses of material may be biasing results at the strata where testing is conducted.

Sources: Riverside County Percolation Test (2011), California Test 750 (Caltrans, 1986), San Bernardino County Percolation Test (1992); USEPA Falling Head Test (USEPA, 1980).

D.4 Specific Considerations for Infiltration Testing

The following subsections are intended to address specific topics that commonly arise in characterizing infiltration rates.

D.4.1 Hydraulic Conductivity Versus Infiltration Rate Versus Percolation Rate

A common misunderstanding is that the “percolation rate” obtained from a percolation test is equivalent to the “infiltration rate” obtained from tests such as a single or double ring infiltrometer test, which is equivalent to the “saturated hydraulic conductivity”. In fact, these terms have different meanings. Saturated hydraulic conductivity is an intrinsic property of a specific soil sample under a given degree of compaction. It is a coefficient in Darcy’s equation (Darcy 1856) that characterizes the flux of water that will occur under a given gradient. The measurement of saturated hydraulic conductivity in a laboratory test is typically referred to as “permeability,” which is a function of the density, structure, stratification, fines, and discontinuities of a given sample under given controlled conditions. In contrast, infiltration rate is an empirical observation of the rate of flux of water into a given soil structure under long-term ponding conditions. Similar to permeability, infiltration rate can be limited by a number of factors, including the layering of soil, density, discontinuities, and initial moisture content. These factors control how quickly water can move through a soil. However, infiltration rate can also be influenced by mounding of groundwater, and the rate at which water dissipates horizontally below a BMP – both of which describe the “capacity” of the “infiltration receptor” to accept this water over an extended period. For this reason, an infiltration test should ideally be conducted for a relatively long duration resembling a series of storm events so that the capacity of the infiltration receptor is evaluated as well as the rate at which water can enter the system. Infiltration rates are generally tested with larger diameter holes, pits, or apparatuses intended to enforce a primarily vertical direction of flux.

In contrast, percolation is tested with small diameter holes, and it is mostly a lateral phenomenon. The direct measurement yielded by a percolation test tends to overestimate the infiltration rate, except perhaps in cases in which a BMP has similar dimensionality to the borehole, such as a dry well. Adjustment of percolation rates may be made to an infiltration rate using a technique such as the Porchet Method.

D.4.2 Cut and Fill Conditions

Cut Conditions: Where the proposed infiltration BMP is to be located in a cut condition, the infiltration surface level at the bottom of the BMP might be far below the existing grade. For example, if the infiltration surface of a proposed BMP is to be located at an elevation that is currently beneath 15 feet of planned cut, how can the proposed infiltration surface be tested to establish a design infiltration rate prior to beginning excavation? The question can be addressed in two ways: First, one of the deeper subsurface tests described above can be used to provide a planning level screening of potential rates at the elevation of the proposed infiltrating surface. These tests can be conducted at depths exceeding 100 feet, and therefore are applicable in most cut conditions. Second, the project can commit to further testing using more reliable methods following bulk excavation to refine or

Appendix D: Approved Infiltration Rate Assessment Methods

adjust infiltration rates, and/or apply higher factors of safety to borehole methods to account for the inherent uncertainty in these measurements and conversions.

Fill Conditions: There are two types of fills – those that are engineered or documented, and those that are undocumented. Undocumented fills are fills placed without engineering controls or construction quality assurance and are subject to great uncertainty. Engineered fills are generally placed using construction quality assurance procedures and may have criteria for grain-size and fines content, and the properties can be very well understood. However, for engineered fills, infiltration rates may still be quite uncertain because of layering and heterogeneities introduced as part of construction that cannot be precisely controlled.

If the bottom of a BMP (infiltration surface) is proposed to be located in a fill location, the infiltration surface may not exist prior to grading. How then can the infiltration rate be determined? For example, if a proposed infiltration BMP is to be located with its bottom elevation in 10 feet of fill, how could one reasonably establish an infiltration rate prior to the fill being placed?

Where possible, infiltration BMPs on fill material should be designed such that their infiltrating surface extends into native soils. Additionally, for shallow fill depths, fill material can be selectively graded (i.e., high permeability granular material placed below proposed BMPs) to provide reliable infiltration properties until the infiltrating water reaches native soils. In some cases, because of considerable fill depth, the extension of the BMP down to natural soil and/or selective grading of fill material may prove infeasible. In addition, fill material will result in some compaction of now buried native soils potentially reducing their ability to infiltrate. In these cases, because of the uncertainty of fill parameters as described above as well as potential compaction of the native soils, an infiltration BMP may not be feasible.

If the source of fill material is defined and this material is known to be of a granular nature and that the native soils below is permeable and will not be highly compacted, infiltration through compacted fill materials may still be feasible. In this case, a project phasing approach could be used including the following general steps, (1) collect samples from areas expected to be used as borrow sites for fill activities, (2) remold samples to approximately the proposed degree of compaction and measure the saturated hydraulic conductivity of remolded samples using laboratory methods, (3) if infiltration rates appear adequate for infiltration, then apply an appropriate factor of safety and use the initial rates for preliminary design, (4) following placement of fill, conduct in-situ testing to refine design infiltration rates and adjust the design as needed; the infiltration rate of native soil below the fill should also be tested at this time to determine if compaction as a result of fill placement has significantly reduced its infiltration rate. The project geotechnical engineer should be involved in decision making whenever infiltration is proposed in the vicinity of engineered fill structures so that potential impacts of infiltration on the strength and stability of fills and pavement structures can be evaluated.

D.4.3 Effects of Direct and Incidental Compaction

It is widely recognized that compaction of soil has a major influence on infiltration rates (Pitt et al. 2008). However, direct (intentional) compaction is an essential aspect of project construction and indirect compaction (such as by movement of machinery, placement of fill, stockpiling of materials, and foot traffic) can be difficult to avoid in some parts of the project site. Infiltration testing strategies

Appendix D: Approved Infiltration Rate Assessment Methods

should attempt to measure soils at a degree of compaction that resembles anticipated post-construction conditions.

Ideally, infiltration systems should be located outside of areas where direct compaction will be required and should be staked off to minimize incidental compaction from vehicles and stockpiling. For these conditions, no adjustment of test results is needed.

However, in some cases, infiltration BMPs will be constructed in areas to be compacted. For these areas, it may be appropriate to include field compaction tests or prepare laboratory samples and conducting infiltration testing to approximate the degree of compaction that will occur in post-construction conditions. Alternatively, testing could be conducted on undisturbed soil, and an additional factor of safety could be applied to account for anticipated infiltration after compaction. To develop a factor of safety associated with incidental compaction, samples could compact to various degrees of compaction, their hydraulic conductivity measured, and a “response curve” developed to relate the degree of compaction to the hydraulic conductivity of the material.

D.4.4 Temperature Effects on Infiltration Rate

The rate of infiltration through soil is affected by the viscosity of water, which in turn is affected by the temperature of water. As such, infiltration rate is strongly dependent on the temperature of the infiltrating water (Cedergren, 1997). For example, Emerson (2008) found that wintertime infiltration rates below a BMP in Pennsylvania were approximately half their peak summertime rates. As such, it is important to consider the effects of temperature when planning tests and interpreting results.

If possible, testing should be conducted at a temperature that approximates the typical runoff temperatures for the site during the times when rainfall occurs. If this is not possible, then the results of infiltration tests should be adjusted to account for the difference between the temperature at the time of testing and the typical temperature of runoff when rainfall occurs. The measured infiltration can be adjusted by the ratio of the viscosity at the test temperature versus the typical temperature when rainfall occurs (Cedergren, 1997), per the following formula:

$$K_{\text{Typical}} = K_{\text{Test}} \times \left(\frac{\mu_{\text{Test}}}{\mu_{\text{Typical}}} \right)$$

where:

K_{Typical} = the typical infiltration rate expected at typical temperatures when rainfall occurs

K_{Test} = the infiltration rate measured or estimated under the conditions of the test

μ_{Typical} = the viscosity of water at the typical temperature expected when rainfall occurs

μ_{Test} = the viscosity of water at the temperature at which the test was conducted

D.4.5 Number of Infiltration Tests Needed

The heterogeneity inherent in soils implies that all but the smallest proposed infiltration facilities would benefit from infiltration tests in multiple locations. The following requirements apply for in situ infiltration/percolation testing:

- In situ infiltration/ percolation testing shall be conducted at a minimum of two locations within 50-feet of each proposed storm water infiltration/ percolation BMP.
- In situ infiltration/percolation testing shall be conducted using an approved method listed in Table D.3-1.
- Testing shall be conducted at approximately the same depth and in the same material as the base of the proposed storm water BMP.

D.5 Selecting a Safety Factor

Monitoring of actual facility performance has shown that the full-scale infiltration rate can be much lower than the rate measured by small-scale testing (King County Department of Natural Resources and Parks, 2009). Factors such as soil variability and groundwater mounding may be responsible for much of this difference. Additionally, the infiltration rate of BMPs naturally declines between maintenance cycles as the BMP surface becomes occluded and particulates accumulate in the infiltrative layer.

Should I use a factor of safety for design infiltration rate?

In the past, infiltration structures have been shown to have a relatively short lifespan. Over 50 percent of infiltration systems either partially or completely failed within the first 5 years of operation (USEPA, 1999). In a Maryland study on infiltration trenches (Lindsey et al., 1991), 53 percent were not operating as designed, 36 percent were clogged, and 22 percent showed reduced filtration. In a study of 12 infiltration basins (Galli, 1992), none with built-in pretreatment systems, all had failed within the first 2 years of operation.

Given the known potential for infiltration BMPs to degrade or fail over time, an appropriate factor of safety applied to infiltration testing results is strongly recommended. This section presents a recommended thought process for selecting a safety factor. This method considers factor of safety to be a function of:

- Site suitability considerations, and
- Design-related considerations.

These factors and the method for using them to compute a safety factor are discussed below. Importantly, this method encourages rigorous site investigation, good pretreatment, and commitments to routine maintenance to provide technically-sound justification for using a lower factor of safety.

D.5.1 Determining Factor of Safety

Worksheet D.5-1 at the end of this section can be used in conjunction with Tables D.5-1 and D.5-2 to determine an appropriate safety factor. Tables D.5-1 and D.5-2 assign point values to design considerations; the values are entered into Worksheet D.5-1, which assign a weighting factor for each design consideration.

The following procedure can be used to estimate an appropriate factor of safety to be applied to the infiltration testing results. When assigning a factor of safety, care should be taken to understand what other factors of safety are implicit in other aspects of the design to avoid incorporating compounding factors of safety that may result in significant over-design.

- 1) For each consideration shown above, determine whether the consideration is a high, medium, or low concern.
- 2) For all high concerns in Table D.5-1, assign a factor value of 3, for medium concerns, assign a factor value of 2, and for low concerns assign a factor value of 1.

Appendix D: Approved Infiltration Rate Assessment Methods

- 3) Multiply each of the factors in Table D.5-1 by 0.25 and then add them together. This should yield a number between 1 and 3.
- 4) For all high concerns in Table D.5-2, assign a factor value of 3, for medium concerns, assign a factor value of 2, and for low concerns assign a factor value of 1.
- 5) Multiply each of the factors in Table D.5-2 by 0.5 and then add them together. This should yield a number between 1 and 3.
- 6) Multiply the two safety factors together to get the final combined safety factor. If the combined safety factor is less than 2, then 2 should be used as the safety factor.
- 7) Divide the tested infiltration rate by the combined safety factor to obtain the adjusted design infiltration rate for use in sizing the infiltration facility.

Note: The minimum combined adjustment factor should not be less than 2.0 and the maximum combined adjustment factor should not exceed 9.0.

D.5.2 Site Suitability Considerations for Selection of an Infiltration Factor of Safety

Considerations related to site suitability include the following:

- Soil assessment methods – the site assessment extent (e.g., number of borings, test pits, etc.) and the measurement method used to estimate the short-term infiltration rate.
- Predominant soil texture/percent fines – soil texture and the percent of fines can influence the potential for clogging. Finer grained soils may be more susceptible to clogging.
- Site soil variability – site with spatially heterogeneous soils (vertically or horizontally) as determined from site investigations are more difficult to estimate average properties for resulting in a higher level of uncertainty associated with initial estimates.
- Depth to seasonal high groundwater/impervious layer – groundwater mounding may become an issue during excessively wet conditions where shallow aquifers or shallow clay lenses are present.
- These considerations are summarized in Table D.5-1, in addition to presenting classification of concern.

Appendix D: Approved Infiltration Rate Assessment Methods

Table D.5-1. Suitability Assessment Related Considerations for Infiltration Facility Safety Factors

Consideration	High Concern – 3 points	Medium Concern – 2 points	Low Concern – 1 point
Assessment methods (See explanation below)	Use of soil survey maps or simple texture analysis to estimate short-term infiltration rates Use of well permeameter or borehole methods without accompanying continuous boring log Relatively sparse testing with direct infiltration methods	Use of well permeameter or borehole methods with accompanying continuous boring log Direct measurement of infiltration area with localized infiltration measurement methods (e.g., infiltrometer) Moderate spatial resolution	Direct measurement with localized (i.e., small-scale) infiltration testing methods at relatively high resolution ¹ or Use of extensive test pit infiltration measurement methods ²
Texture class	Silty and clayey soils with significant fines	Loamy soils	Granular to slightly loamy soils
Site soil variability	Highly variable soils indicated from site assessment, or Unknown variability	Soil borings/test pits indicate moderately homogeneous soils	Soil borings/test pits indicate relatively homogeneous soils
Depth to groundwater/ impervious layer	<5 ft below facility bottom	5-15 ft below facility bottom	>15 below facility bottom

Notes:

1. Localized (i.e., small scale) testing refers to methods such as the double-ring infiltrometer and borehole tests)
2. Extensive infiltration testing refers to methods that include excavating a significant portion of the proposed infiltration area, filling the excavation with water, and monitoring drawdown. The excavation should be to the depth of the proposed infiltration surface and ideally be at least 30 to 100 ft².

D.5.3 Design Related Considerations for Selection of an Infiltration Factor of Safety

Design related considerations include the following:

- Level of pretreatment and expected influent sediment loads – credit should be given for good pretreatment to account for the reduced probability of clogging from high sediment loading. Appendix B.6 describes performance criteria for “flow-through treatment” based on 80 percent capture of total suspended solids, which provides excellent levels of pretreatment. Additionally, the Washington State Technology Acceptance Protocol-Ecology provides a certification for “pre-treatment” based on 50 percent removal of TSS, which provides moderate levels of treatment. Current approved technologies are listed at <http://www.ecy.wa.gov/programs/wq/stormwater/newtech/technologies.html>. Use of certified technologies can allow a lower factor of safety. Also, facilities designed to capture runoff from relatively clean surfaces such as rooftops are likely to see low sediment loads and therefore may be designed with lower safety factors. Finally, the amount of landscaped area and its vegetation coverage characteristics should be considered. For example, in arid areas with more soils exposed, open areas draining to infiltration systems may contribute excessive sediments.

Appendix D: Approved Infiltration Rate Assessment Methods

- Compaction during construction – proper construction oversight is needed during construction to ensure that the bottoms of infiltration facility are not impacted by significant incidental compaction. Facilities that use proper construction practices and oversight need less restrictive safety factors.

Table D.5-2. Design Related Considerations for Infiltration Facility Safety Factors

Consideration	High Concern – 3 points	Medium Concern – 2 points	Low Concern – 1 point
Level of pretreatment/ expected influent sediment loads	Limited pretreatment using gross solids removal devices only, such as hydrodynamic separators, racks and screens AND tributary area includes landscaped areas, steep slopes, high traffic areas, road sanding, or any other areas expected to produce high sediment, trash, or debris loads	Good pretreatment with BMPs that mitigate coarse sediments such as vegetated swales AND influent sediment loads from the tributary area are expected to be moderate (e.g., low traffic, mild slopes, stabilized pervious areas, etc.). Performance of pretreatment consistent with “pretreatment BMP performance criteria” (50% TSS removal) in Appendix B.6	Excellent pretreatment with BMPs that mitigate fine sediments such as bioretention or media filtration OR sedimentation or facility only treats runoff from relatively clean surfaces, such as rooftops/non-sanded road surfaces. Performance of pretreatment consistent with “flow-through treatment control BMP performance criteria” (i.e., 80% TSS removal) in Appendix B.6
Redundancy/resiliency	No “backup” system is provided; the system design does not allow infiltration rates to be restored relatively easily with maintenance	The system has a backup pathway for treated water to discharge if clogging occurs <u>or</u> infiltration rates can be restored via maintenance.	The system has a backup pathway for treated water to discharge if clogging occurs <u>and</u> infiltration rates can be relatively easily restored via maintenance.
Compaction during construction	Construction of facility on a compacted site or increased probability of unintended/ indirect compaction.	Medium probability of unintended/ indirect compaction.	Equipment traffic is effectively restricted from infiltration areas during construction and there is low probability of unintended/ indirect compaction.

D.5.4 Implications of a Factor of Safety in BMP Feasibility and Design

The method above will provide safety factors in the range of 2 to 9. From a simplified practical perspective, this means that the size of the facility will need to increase in area from 2 to 9 times relative to that which might be used without a safety factor. Clearly, numbers toward the upper end of this range will make all but the best locations prohibitive in land area and cost.

To make BMPs more feasible and cost effective, steps should be taken to plan and execute the implementation of infiltration BMPs in a way that will reduce the safety factors needed for those projects. A commitment to effective site design and source control thorough site investigation, use of effective pretreatment controls, good construction practices, and restoration of the infiltration rates of soils that are damaged by prior compaction should lower the safety factor that should be applied

Appendix D: Approved Infiltration Rate Assessment Methods

to help improve the long-term reliability of the system and reduce BMP construction cost. Although these practices decrease the recommended safety factor, they do not totally mitigate the need to apply a factor of safety. The minimum recommended safety factor of 2.0 is intended to account for the remaining uncertainty and long-term deterioration that cannot be technically mitigated.

Because there is potential for an applicant to “exaggerate” factor of safety to artificially prove infeasibility, an upper cap on the factor of safety is proposed for feasibility screening. A maximum factor of safety of 2.0 is recommended for infiltration feasibility screening such that an artificially high factor of safety cannot be used to inappropriately rule out infiltration, unless justified. If the site passes the feasibility analysis at a factor of safety of 2.0, then infiltration must be investigated, but a higher factor of safety may be selected at the discretion of the design engineer.

Appendix D: Approved Infiltration Rate Assessment Methods

Worksheet D.5-1. Factor of Safety and Design Infiltration Rate Worksheet

Factor of Safety and Design Infiltration Rate Worksheet		Worksheet D.5-1			
Factor Category		Factor Description	Assigned Weight (w)	Factor Value (v)	Product (p) $p = w \times v$
A	Suitability Assessment	Soil assessment methods	0.25		
		Predominant soil texture	0.25		
		Site soil variability	0.25		
		Depth to groundwater/impervious layer	0.25		
		Suitability Assessment Safety Factor, $S_A = \sum p$			
B	Design	Level of pretreatment/expected sediment loads	0.5		
		Redundancy/resiliency	0.25		
		Compaction during construction	0.25		
		Design Safety Factor, $S_B = \sum p$			
Combined Safety Factor, $S_{total} = S_A \times S_B$					
Observed Infiltration Rate, inch/hr, $K_{observed}$ (Corrected for test-specific bias)					
Design Infiltration Rate, inches/hour, $K_{design} = K_{observed} / S_{total}$					
Supporting Data					
Briefly describe infiltration test and provide reference to test forms:					

Appendix



AUTHORITY BMP DESIGN MANUAL

BMP Design Fact Sheets

Appendix E BMP Design Fact Sheets

The following fact sheets were developed to assist the project applicants with designing BMPs to meet the storm water obligations:

MS4 Category	Manual Category	Design Fact Sheet
Source Control	Source Control	SC: Source Control BMP Requirements
Site Design	Site Design	SD-Q: Large Trash Generating Facilities SD-A: Tree Wells SD-B: Impervious Area Dispersion SD-C: Green Roofs SD-D: Permeable Pavement (Site Design BMP) SD-E: Rain Barrels SD-F Amended Soils
Retention	Harvest and Use	HU-1: Cistern
	Infiltration	INF-1: Infiltration Basins INF-2: Bioretention INF-3: Permeable Pavement (Pollutant Control)
	Partial Retention	PR-1: Biofiltration with Partial Retention
Biofiltration	Biofiltration	BF-1: Biofiltration BF-2: Nutrient Sensitive Media Design BF-3: Proprietary Biofiltration
Flow-through Treatment Control	Flow-through Treatment Control with Alternative Compliance	FT-1: Vegetated Swales FT-2: Media Filters FT-3: Sand Filters FT-4: Dry Extended Detention Basin FT-5: Proprietary Flow-through Treatment Control
NA	NA	PL: Plant List

E.1 Fact Sheet Quick Guide

<p>BF-1 Biofiltration 1</p>  <p><i>Location: 43rd Street and Logan Avenue, San Diego, California</i> 3</p>	<p>MS4 Permit Category 2</p> <p>Biofiltration</p> <hr/> <p>Manual Category</p> <p>Biofiltration</p> <hr/> <p>Applicable Performance Standard</p> <p>Pollutant Control Flow Control</p> <hr/> <p>Primary Benefits</p> <p>Treatment</p>
---	---

Description	4
<p>Biofiltration (Bioretention with underdrain) facilities are vegetated surface water systems that filter water through vegetation, and soil or engineered media prior to discharge via underdrain or overflow to the downstream conveyance system.</p>	

Fact Sheet Key	
1	Best Management Practice (BMP) Title
2	Categories, Standards, and Benefits
3	BMP Image
4	<p>Main Content; Categories Include</p> <ul style="list-style-type: none"> • Description • Design Adaptations for Project Goals • Recommended Siting Criteria • Recommended BMP Component Dimensions • Design Criteria and Considerations • Conceptual Design and Sizing Approach for <ul style="list-style-type: none"> ○ -Site Design ○ -Storm Water Pollutant Control Only ○ -Integrated Storm Water Pollutant Control and Flow Control • Maintenance Overview • Summary of Standard Inspection and Maintenance

This page intentionally left blank

E.2 Source Control BMP Requirements

Worksheet E.22-1. Source Control BMP Requirements

How to comply: Projects shall comply with this requirement by implementing all source control BMPs listed in this section that are applicable to their project. Applicability shall be determined through consideration of the development project's features and anticipated pollutant sources. Appendix E.1 provides guidance for identifying source control BMPs applicable to a project. Form H-4 in Appendix A shall be used to document compliance with source control BMP requirements.

How to use this worksheet:

- 1) Review Column 1 and identify which of these potential sources of storm water pollutants apply to your site. Check each box that applies.
- 2) Review Column 2 and incorporate all of the corresponding applicable BMPs in your project site plan.
- 3) Review Columns 3 and 4 and incorporate all of the corresponding applicable permanent controls and operational BMPs in a table in your project-specific storm water management report. Describe your specific BMPs in an accompanying narrative and explain any special conditions or situations that required omitting BMPs or substituting alternatives.
- 4) Review Column 5 and incorporate all of the corresponding applicable Authority Source Control BMPs in a table in your project-specific storm water management report. Describe any special conditions that require omitting BMPs or substituting alternatives. Detailed descriptions of BMPs are found in Appendix B of the SAN SWMP (www.san.org/green). Note that all BMPs listed in Appendix B of the SAN SWMP, as applicable, apply to all areas of the Authority jurisdiction.

This page intentionally left blank

If These Sources Will Be on the Project Site Then Your SWQMP Shall Consider These Source Control BMPs			
1 Potential Sources of Runoff Pollutants	2 Permanent Controls—Show on Drawings	3 Permanent Controls—List in Table and Narrative	4 Operational BMPs—Include in Table and Narrative	5 Authority Source Control BMPs—Include in Table and Narrative
<input type="checkbox"/> A. Onsite storm drain inlets <input type="checkbox"/> Not Applicable	<input type="checkbox"/> Locations of inlets.	<input type="checkbox"/> Mark all inlets with the words “No Dumping! Flows to Bay” or similar.	<input type="checkbox"/> Maintain and periodically repaint or replace inlet markings. <input type="checkbox"/> Provide storm water pollution prevention information to new site owners, lessees, or operators. <input type="checkbox"/> See applicable operational BMPs in Fact Sheet SC-44, “Drainage System Maintenance,” in the CASQA Stormwater Quality Handbooks at www.cabmphandbooks.com . <input type="checkbox"/> Include the following in lease agreements: “Tenant shall not allow anyone to discharge anything to storm drains or to store or deposit materials so as to create a potential discharge to storm drains.”	<input type="checkbox"/> BMP SC17 – Storm Drain Maintenance
<input type="checkbox"/> B. Interior floor drains and elevator shaft sump pumps <input type="checkbox"/> Not Applicable		<input type="checkbox"/> State that interior floor drains and elevator shaft sump pumps will be plumbed to sanitary sewer.	<input type="checkbox"/> Inspect and maintain drains to prevent blockages and overflow.	<input type="checkbox"/> BMP SC01 – Non-Storm Water Management <input type="checkbox"/> BMP SC17 – Storm Drain Maintenance
<input type="checkbox"/> C. Interior parking garages <input type="checkbox"/> Not Applicable		<input type="checkbox"/> State that parking garage floor drains will be plumbed to the sanitary sewer.	<input type="checkbox"/> Inspect and maintain drains to prevent blockages and overflow.	<input type="checkbox"/> BMP SC01 – Non-Storm Water Management <input type="checkbox"/> BMP SC17 – Storm Drain Maintenance
<input type="checkbox"/> D1. Need for future indoor & structural pest control <input type="checkbox"/> Not Applicable		<input type="checkbox"/> Note building design features that discourage entry of pests.	<input type="checkbox"/> Provide Integrated Pest Management information to owners, lessees, and operators.	<input type="checkbox"/> BMP SC09 – Building and Grounds Maintenance

If These Sources Will Be on the Project Site Then Your SWQMP shall consider These Source Control BMPs			
1 Potential Sources of Runoff Pollutants	2 Permanent Controls—Show on Drawings	3 Permanent Controls—List in Table and Narrative	4 Operational BMPs—Include in Table and Narrative	5 Authority Source Control BMPs—Include in Table and Narrative
<input type="checkbox"/> D2. Landscape/ Outdoor Pesticide Use <input type="checkbox"/> Not Applicable	<input type="checkbox"/> Show locations of existing trees or areas of shrubs and ground cover to be undisturbed and retained. <input type="checkbox"/> Show self-retaining landscape areas, if any. <input type="checkbox"/> Show storm water treatment facilities.	<p>State that final landscape plans will accomplish all of the following.</p> <input type="checkbox"/> Preserve existing drought tolerant trees, shrubs, and ground cover to the maximum extent possible. <input type="checkbox"/> Design landscaping to minimize irrigation and runoff, to promote surface infiltration where appropriate, and to minimize the use of fertilizers and pesticides that can contribute to storm water pollution. <input type="checkbox"/> Where landscaped areas are used to retain or detain storm water, specify plants that are tolerant of periodic saturated soil conditions. <input type="checkbox"/> Consider using pest-resistant plants, especially adjacent to hardscape. <input type="checkbox"/> To ensure successful establishment, select plants appropriate to site soils, slopes, climate, sun, wind, rain, land use, air movement, ecological consistency, and plant interactions.	<input type="checkbox"/> Maintain landscaping using minimum or no pesticides. <input type="checkbox"/> See applicable operational BMPs in Fact Sheet SC-41, “Building and Grounds Maintenance,” in the CASQA Stormwater Quality Handbooks at www.cabmphandbooks.com . <input type="checkbox"/> Provide IPM information to new owners, lessees and operators.	<input type="checkbox"/> BMP SC01 – Non-Storm Water Management <input type="checkbox"/> BMP SC09 – Building and Grounds Maintenance
<input type="checkbox"/> E. Ponds, decorative fountains, and other water features. <input type="checkbox"/> Not Applicable	<input type="checkbox"/> Show location of water feature and a sanitary sewer cleanout in an accessible area within 10 feet.	<input type="checkbox"/> If Authority requires the water feature to be plumbed to the sanitary sewer, place a note on the plans and state in the narrative that this connection will be made according to local requirements.	<input type="checkbox"/> See applicable operational BMPs in Fact Sheet SC-72, “Fountain and Pool Maintenance,” in the CASQA Stormwater Quality Handbooks at www.cabmphandbooks.com .	

If These Sources Will Be on the Project Site Then Your SWQMP shall consider These Source Control BMPs			
1 Potential Sources of Runoff Pollutants	2 Permanent Controls—Show on Drawings	3 Permanent Controls—List in Table and Narrative	4 Operational BMPs—Include in Table and Narrative	5 Authority Source Control BMPs—Include in Table and Narrative
<input type="checkbox"/> F. Food service <input type="checkbox"/> Not Applicable	<input type="checkbox"/> For restaurants, grocery stores, and other food service operations, show location (indoors or in a covered area outdoors) of a floor sink or other area for cleaning floor mats, containers, and equipment. <input type="checkbox"/> On the drawing, show a note that this drain will be connected to a grease interceptor before discharging to the sanitary sewer.	<input type="checkbox"/> Describe the location and features of the designated cleaning area. <input type="checkbox"/> Describe the items to be cleaned in this facility and how it has been sized to ensure that the largest items can be accommodated.		<input type="checkbox"/> BMP SC01 – Non-Storm Water Management <input type="checkbox"/> BMP SC04 – Aircraft, Ground Vehicle, and Equipment Cleaning
<input type="checkbox"/> G. Refuse areas <input type="checkbox"/> Not Applicable	<input type="checkbox"/> Show where site refuse and recycled materials will be handled and stored for pickup. See local municipal requirements for sizes and other details of refuse areas. <input type="checkbox"/> If dumpsters or other receptacles are outdoors, show how the designated area will be covered, graded, and paved to prevent runoff and show locations of berms to prevent runoff from the area. Also show how the designated area will be protected from wind dispersal. <input type="checkbox"/> Any drains from dumpsters, compactors, and tallow bin areas shall be connected to a grease removal device before discharge to sanitary sewer.	<input type="checkbox"/> State how site refuse will be handled and provide supporting detail to what is shown on plans. <input type="checkbox"/> State that signs will be posted on or near dumpsters with the words “Do not dump hazardous materials here” or similar.	<input type="checkbox"/> State how the following will be implemented: <input type="checkbox"/> Provide adequate number of receptacles. Inspect receptacles regularly; repair or replace leaky receptacles. Keep receptacles covered. Prohibit/prevent dumping of liquid or hazardous wastes. Post “no hazardous materials” signs. Inspect and pick up litter daily and clean up spills immediately. Keep spill control materials available on- site. See Fact Sheet SC-34, “Waste Handling and Disposal” in the CASQA Stormwater Quality Handbooks at www.cabmphandbooks.com .	<input type="checkbox"/> BMP SC08 – Waste Handling and Disposal

If These Sources Will Be on the Project Site Then Your SWQMP shall consider These Source Control BMPs			
1 Potential Sources of Runoff Pollutants	2 Permanent Controls—Show on Drawings	3 Permanent Controls—List in Table and Narrative	4 Operational BMPs—Include in Table and Narrative	5 Authority Source Control BMPs—Include in Table and Narrative
<input type="checkbox"/> H. Industrial processes. <input type="checkbox"/> Not Applicable	<input type="checkbox"/> Show process area.	<input type="checkbox"/> If industrial processes are to be located onsite, state: “All process activities to be performed indoors where possible. No processes to drain to exterior or to storm drain system.”	<input type="checkbox"/> See Fact Sheet SC-10, “Non- Stormwater Discharges” in the CASQA Stormwater Quality Handbooks at www.cabmphandbooks.com .	<input type="checkbox"/> BMP SC01 – Non-Storm Water Management <input type="checkbox"/> BMP SC02A – Outdoor Equipment Operations and Maintenance Areas <input type="checkbox"/> BMP SC02B – Aircraft, Ground Vehicle, and Equipment Maintenance <input type="checkbox"/> BMP SC02C – Electric Vehicle Maintenance and Charging <input type="checkbox"/> BMP SC05 – Aircraft Deicing/Anti-Icing
<input type="checkbox"/> I. Outdoor storage of equipment or materials. (See rows J and K for source control measures for vehicle cleaning, repair, and maintenance.) <input type="checkbox"/> Not Applicable	<input type="checkbox"/> Show any outdoor storage areas, including how materials will be covered. Show how areas will be graded and bermed to prevent run-on or runoff from area and protected from wind dispersal. <input type="checkbox"/> Storage of non-hazardous liquids shall be covered by a roof and/or drain to the sanitary sewer system, and be contained by berms, dikes, liners, or vaults. <input type="checkbox"/> Storage of hazardous materials and wastes must be in compliance with the local hazardous materials ordinance and a Hazardous Materials (HazMat) Management Plan for the site. HazMat Management Plans must be on file with Authority.	<input type="checkbox"/> Include a detailed description of materials to be stored, storage areas, and structural features to prevent pollutants from entering storm drains. Where appropriate, reference documentation of compliance with the requirements of local Hazardous Materials Programs for: <ul style="list-style-type: none"> ▪ Hazardous Waste Generation ▪ Hazardous Materials Release Response and Inventory ▪ California Accidental Release Prevention Program ▪ Aboveground Storage Tank ▪ Uniform Fire Code Article 80 Section 103(b) & (c) 1991 ▪ Underground Storage Tank 	<input type="checkbox"/> See the Fact Sheets SC-31, “Outdoor Liquid Container Storage” and SC-33, “Outdoor Storage of Raw Materials” in the CASQA Stormwater Quality Handbooks at www.cabmphandbooks.com .	<input type="checkbox"/> BMP SC07 – Outdoor Material Storage

If These Sources Will Be on the Project Site Then Your SWQMP shall consider These Source Control BMPs			
1 Potential Sources of Runoff Pollutants	2 Permanent Controls—Show on Drawings	3 Permanent Controls—List in Table and Narrative	4 Operational BMPs—Include in Table and Narrative	5 Authority Source Control BMPs—Include in Table and Narrative
<input type="checkbox"/> J. Vehicle and Equipment Cleaning <input type="checkbox"/> Not Applicable	<input type="checkbox"/> Show on drawings as appropriate: (1) Commercial/industrial facilities having vehicle /equipment cleaning needs shall either provide a covered, bermed area for washing activities or discourage vehicle/equipment washing by removing hose bibs and installing signs prohibiting such uses. (2) Washing areas for cars, vehicles, and equipment shall be paved, designed to prevent run-on to or runoff from the area, and plumbed to drain to the sanitary sewer. (3) Commercial car wash facilities shall be designed such that no runoff from the facility is discharged to the storm drain system. Wastewater from the facility shall discharge to the sanitary sewer, or a wastewater reclamation system shall be installed.	<input type="checkbox"/> If a car wash area is not provided, describe measures taken to discourage onsite car washing and explain how these will be enforced.	Describe operational measures to implement the following (if applicable): <input type="checkbox"/> Washwater from aircraft, vehicle and equipment washing operations shall not be discharged to the storm drain system. <input type="checkbox"/> Vehicle maintenance shops and similar shall use dry wash methods, capture all wash water, or wash offsite. <input type="checkbox"/> See Fact Sheet SC-21, “Vehicle and Equipment Cleaning,” in the CASQA Stormwater Quality Handbooks at www.cabmphandbooks.com	<input type="checkbox"/> BMP SC01 – Non-Storm Water Management <input type="checkbox"/> BMP SC04 – Aircraft, Ground Vehicle, and Equipment Cleaning

If These Sources Will Be on the Project Site Then Your SWQMP shall consider These Source Control BMPs			
1 Potential Sources of Runoff Pollutants	2 Permanent Controls—Show on Drawings	3 Permanent Controls—List in Table and Narrative	4 Operational BMPs—Include in Table and Narrative	5 Authority Source Control BMPs—Include in Table and Narrative
<ul style="list-style-type: none"> <input type="checkbox"/> K. Vehicle/Equipment Repair and Maintenance <input type="checkbox"/> Not Applicable 	<ul style="list-style-type: none"> <input type="checkbox"/> Accommodate all vehicle equipment repair and maintenance indoors. Or designate an outdoor work area and design the area to protect from rainfall, run-on runoff, and wind dispersal. <input type="checkbox"/> Show secondary containment for exterior work areas where motor oil, brake fluid, gasoline, diesel fuel, radiator fluid, acid-containing batteries or other hazardous materials or hazardous wastes are used or stored. Drains shall not be installed within the secondary containment areas. <input type="checkbox"/> Add a note on the plans that states either (1) there are no floor drains, or (2) floor drains are connected to wastewater pretreatment systems prior to discharge to the sanitary sewer and an industrial waste discharge permit will be obtained. 	<ul style="list-style-type: none"> <input type="checkbox"/> State that no vehicle repair or maintenance will be done outdoors, or else describe the required features of the outdoor work area. <input type="checkbox"/> State that there are no floor drains or if there are floor drains, note the agency from which an industrial waste discharge permit will be obtained and that the design meets that agency's requirements. <input type="checkbox"/> State that there are no tanks, containers or sinks to be used for parts cleaning or rinsing or, if there are, note the agency from which an industrial waste discharge permit will be obtained and that the design meets that agency's requirements. 	<p>In the report, note that all of the following restrictions apply to use the site:</p> <ul style="list-style-type: none"> <input type="checkbox"/> No person shall dispose of, nor permit the disposal, directly or indirectly of vehicle fluids, hazardous materials, or rinsewater from parts cleaning into storm drains. <input type="checkbox"/> No vehicle fluid removal shall be performed outside a building, nor on asphalt or ground surfaces, whether inside or outside a building, except in such a manner as to ensure that any spilled fluid will be in an area of secondary containment. Leaking vehicle fluids shall be contained or drained from the vehicle immediately. <input type="checkbox"/> No person shall leave unattended drip parts or other open containers containing vehicle fluid, unless such containers are in use or in an area of secondary containment. 	<ul style="list-style-type: none"> <input type="checkbox"/> BMP SC01 – Non-Storm Water Management <input type="checkbox"/> BMP SC02A – Outdoor Equipment Operations and Maintenance Areas <input type="checkbox"/> BMP SC02B – Aircraft, Ground Vehicle, and Equipment Maintenance <input type="checkbox"/> BMP SC02C – Electric Vehicle Maintenance and Charging

If These Sources Will Be on the Project Site Then Your SWQMP shall consider These Source Control BMPs			
1 Potential Sources of Runoff Pollutants	2 Permanent Controls—Show on Drawings	3 Permanent Controls—List in Table and Narrative	4 Operational BMPs—Include in Table and Narrative	5 Authority Source Control BMPs—Include in Table and Narrative
<input type="checkbox"/> L. Fuel Dispensing Areas <input type="checkbox"/> Not Applicable	<input type="checkbox"/> Fueling areas ¹ shall have impermeable floors (i.e., portland cement concrete or equivalent smooth impervious surface) that are (1) graded at the minimum slope necessary to prevent ponding; and (2) separated from the rest of the site by a grade break that prevents run-on of storm water to the MEP. <input type="checkbox"/> Fueling areas shall be covered by a canopy that extends a minimum of ten feet in each direction from each pump. [Alternative: The fueling area must be covered and the cover's minimum dimensions must be equal to or greater than the area within the grade break or fuel dispensing area ¹ .] The canopy [or cover] shall not drain onto the fueling area.		<input type="checkbox"/> The tenant or property owner shall dry sweep the fueling area routinely. <input type="checkbox"/> See the Business Guide Sheet, “Automotive Service—Service Stations” in the CASQA Stormwater Quality Handbooks at www.cabmphandbooks.com .	<input type="checkbox"/> BMP SC03 – Aircraft, Ground Vehicle, and Equipment Fueling

Notes:

1. The fueling area shall be defined as the area extending a minimum of 6.5 feet from the corner of each fuel dispenser or the length at which the hose and nozzle assembly may be operated plus a minimum of one foot, whichever is greater.

If These Sources Will Be on the Project Site Then Your SWQMP shall consider These Source Control BMPs			
1 Potential Sources of Runoff Pollutants	2 Permanent Controls—Show on Drawings	3 Permanent Controls—List in Table and Narrative	4 Operational BMPs—Include in Table and Narrative	5 Authority Source Control BMPs—Include in Table and Narrative
<p>M. Loading Docks <input type="checkbox"/> Not Applicable</p>	<ul style="list-style-type: none"> <input type="checkbox"/> Show a preliminary design for the loading dock area, including roofing and drainage. Loading docks shall be covered and/or graded to minimize run-on to and runoff from the loading area. Roof downspouts shall be positioned to direct storm water away from the loading area. Water from loading dock areas should be drained to the sanitary sewer where feasible. Direct connections to storm drains from depressed loading docks are prohibited. <input type="checkbox"/> Loading dock areas draining directly to the sanitary sewer shall be equipped with a spill control valve or equivalent device, which shall be kept closed during periods of operation. <input type="checkbox"/> Provide a roof overhang over the loading area or install door skirts (cowling) at each bay that enclose the end of the trailer. 		<ul style="list-style-type: none"> <input type="checkbox"/> Move loaded and unloaded items indoors as soon as possible. <input type="checkbox"/> See Fact Sheet SC-30, “Outdoor Loading and Unloading,” in the CASQA Stormwater Quality Handbooks at www.cabmphandbooks.com. 	<ul style="list-style-type: none"> <input type="checkbox"/> BMP SC06 – Outdoor Loading and Unloading of Materials
<ul style="list-style-type: none"> <input type="checkbox"/> N. Fire Sprinkler Test Water <input type="checkbox"/> Not Applicable 		<ul style="list-style-type: none"> <input type="checkbox"/> Provide a means to drain fire sprinkler test water to the sanitary sewer. 	<ul style="list-style-type: none"> <input type="checkbox"/> See the note in Fact Sheet SC-41, “Building and Grounds Maintenance,” in the CASQA Stormwater Quality Handbooks at www.cabmphandbooks.com. 	<ul style="list-style-type: none"> <input type="checkbox"/> BMP SC13 – Fire Fighting Foam Discharge

If These Sources Will Be on the Project Site Then Your SWQMP shall consider These Source Control BMPs			
1 Potential Sources of Runoff Pollutants	2 Permanent Controls—Show on Drawings	3 Permanent Controls—List in Table and Narrative	4 Operational BMPs—Include in Table and Narrative	5 Authority Source Control BMPs—Include in Table and Narrative
<p>O. Miscellaneous Drain or Wash Water</p> <ul style="list-style-type: none"> <input type="checkbox"/> Boiler drain lines <input type="checkbox"/> Condensate drain lines <input type="checkbox"/> Rooftop equipment <input type="checkbox"/> Drainage sumps <input type="checkbox"/> Roofing, gutters, and trim <p><input type="checkbox"/> Not Applicable</p>		<ul style="list-style-type: none"> <input type="checkbox"/> Boiler drain lines shall be directly or indirectly connected to the sanitary sewer system and may not discharge to the storm drain system. <input type="checkbox"/> Condensate drain lines may discharge to landscaped areas if the flow is small enough that runoff will not occur. Condensate drain lines may not discharge to the storm drain system. Consider harvest and use of condensate. <input type="checkbox"/> Rooftop mounted equipment with potential to produce pollutants shall be roofed and/or have secondary containment. <input type="checkbox"/> Any drainage sumps onsite shall feature a sediment sump to reduce the quantity of sediment in pumped water. <input type="checkbox"/> Avoid roofing, gutters, and trim made of copper or other unprotected metals that may leach into runoff. 		<ul style="list-style-type: none"> <input type="checkbox"/> BMP SC01 – Non-Storm Water Management
<ul style="list-style-type: none"> <input type="checkbox"/> P. Plazas, sidewalks, parking lots, runways, ramp, and taxiways. <input type="checkbox"/> Not Applicable 			<ul style="list-style-type: none"> <input type="checkbox"/> Plazas, sidewalks, parking lots, runways, ramp, and taxiways shall be swept regularly to prevent the accumulation of litter and debris. <input type="checkbox"/> Debris from pressure washing shall be collected to prevent entry into the storm drain system. Washwater containing any cleaning agent or degreaser shall be collected and discharged to the sanitary sewer and not discharged to a storm drain. 	<ul style="list-style-type: none"> <input type="checkbox"/> BMP SC01 – Non-Storm Water Management <input type="checkbox"/> BMP SC12 – Outdoor Wash Down/Sweeping (Apron Washing, Ramp Scrubbing) <input type="checkbox"/> BMP SC15 – Runway Rubber Removal <input type="checkbox"/> BMP SC16 – Parking Lots

This page intentionally left blank

E.3 SD-Q Large Trash Generating Facilities



MS4 Permit Category

Source Control

Manual Category

Source Control

Applicable Performance Standard

Source Control

Primary Benefits

Source Control

Description

Storm water runoff from areas where trash is stored or disposed of can be polluted. In addition, loose trash and debris can be easily transported by water or wind to nearby storm drain inlets, channels, and/or creeks. Trash generating facilities that generate large amounts of trash require special attention to protect trash storage areas from rainfall, run-on, runoff, and wind dispersal. Large trash-generating or trash build-up areas include but are not limited to restaurants, supermarkets, “big box” retail stores serving food, and pet stores. The Authority may designate additional facilities if they are likely to generate or accumulate large quantities of trash.

Example isometric view and plan view of an allowable trash enclosure facility is presented below. The project applicant may be allowed to use an alternative trash enclosure design that might be more appropriate for a project site if the alternative design is approved by the Authority.

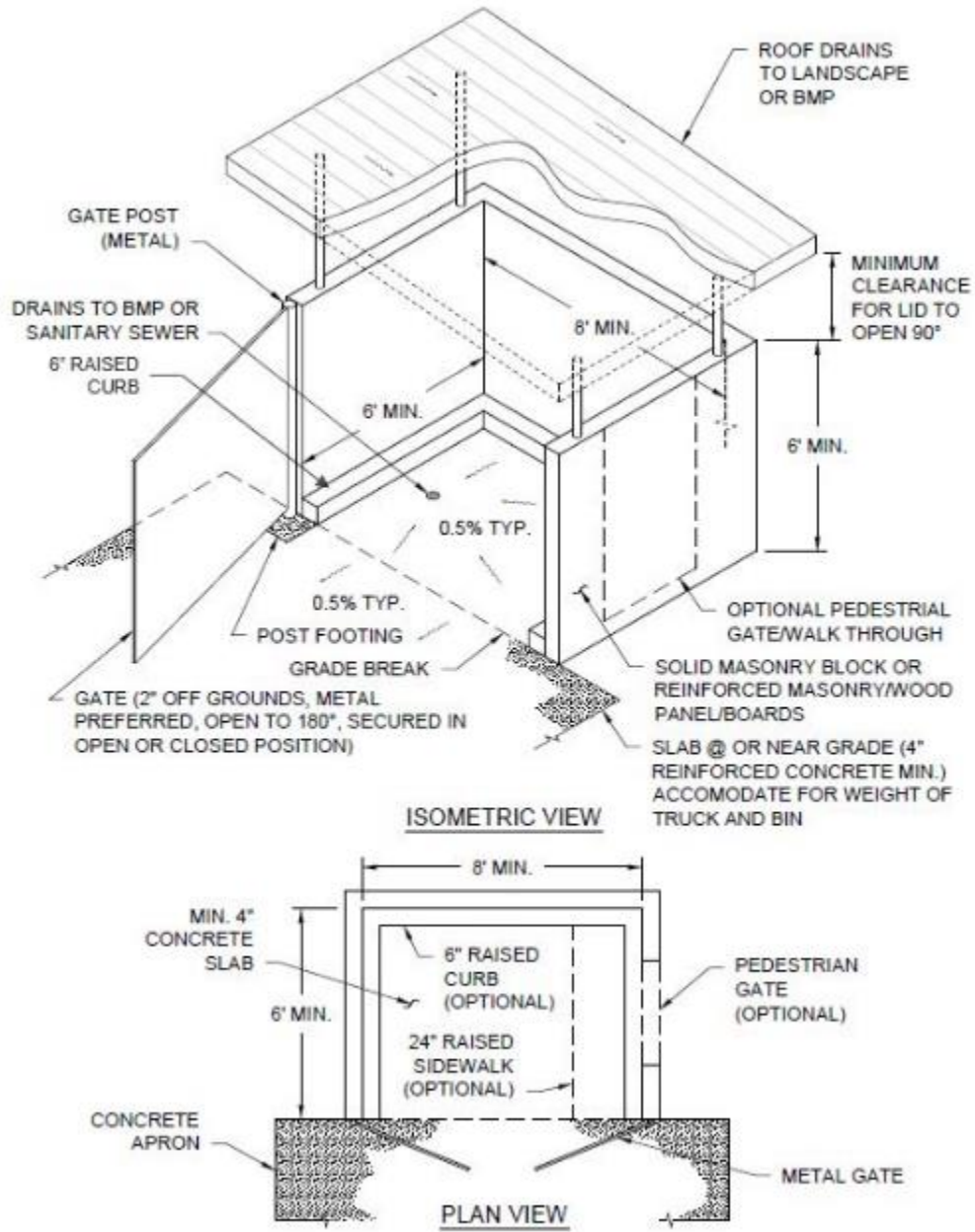

Typical Isometric and Plan View of a Trash Enclosure BMP

Design Adaptations for Project Goals

Source control BMPs reduce the amount of pollutants that are generated. This fact sheet contains details on the additional measures required to prevent or reduce pollutants in storm water runoff associated with trash storage and handling for large trash generating facilities. The requirements presented here are in addition to the requirements of SC-5, which requires all development projects to protect trash storage areas from rainfall, run-on, runoff, and wind dispersal:

- **Areas where trash containers are stored must be enclosed on four sides to prevent offsite transport of trash.** Four-sided trash enclosures typically consist of three walled sides and one gated side. Trash enclosures limit the potential for trash to pollute storm water runoff by limiting mobilization mechanisms (runoff, run-on, and wind dispersal).
- **Trash enclosures must be covered to minimize direct precipitation and prevent rainfall from entering enclosures.** Structural overhead covers are required as container lids are often left open.
- **Enclosures must be hydraulically isolated from surrounding areas.** Slabs shall be sloped such that any leaked materials will be contained within the closure. Drains must be provided that capture and direct potential leaks to the sanitary sewer or appropriate BMPs. Divert runoff from surrounding areas away from the enclosure to prevent contamination and dispersion of collected materials.
- **Owner must provide BMP storm water training to employees.** Employee participation is required to ensure that enclosures are properly maintained and kept clean.

Design Criteria and Considerations

All trash shall be stored in weather-protected receptacles/bins and recyclable materials shall be protected against adverse weather conditions, which might render the collected materials unmarketable. Trash enclosure dimensions will vary based on projected usage and the following information is offered as an aid in planning new projects. Businesses that use dumpsters must design the enclosure to accommodate three-yard containers at a minimum. The tenants may use any dumpster size that is appropriate for their needs, but the enclosure must be able to accommodate different tenants with varying waste production, including any recycling requirements. The design of the enclosure must be signed and sealed by a California licensed engineer. Substantiating structural calculations may be required. The location and design of the enclosure will require review and approval by the Authority. Building permits may be required.

The following recommendations for typical bin sizes are adopted from the City of Escondido trash enclosure guidelines. The following bin/container measurements are approximate (add 8" to width for side pockets):

Typical Trash Bin Sizes

Size	Width	Depth	Height (front)	Height (back)
3 cubic yard	72" bin, 81" plus lid	43"	42"	70"
4 cubic yard	72" bin, 81" plus lid	56"	72"	72"

Filled weight should not exceed 1,000 pounds.

- 1) Enclosures shall be structurally strong and constructed of reinforced masonry block or wood panels/boards. Structural requirements for enclosures are detailed in the City of San Diego specifications for Wood and Masonry Fences.

<http://www.sandiego.gov/development-services/pdf/industry/infobulletin/ib223.pdf>

- 2) The enclosure should be constructed to the following minimum inside dimensions to accommodate three cubic-yard dumpsters (larger enclosures may be necessary to accommodate additional trash bins, recycling bins, and accessibility):

No. of Bins	Loading	Width	Depth	Height
One	Front	8'	6'	6'
One	Side	7.5'	8'	6'
Two	Front	16'	6'	6'
Two	Side	8'	16'	6'

- 1) The enclosure slab should be designed to keep storm water drainage out of the enclosure area, typically sloped at 0.5 percent. Slab construction specifications will vary according to methods of construction but should be at least 4 inches of reinforced concrete.
- 2) Sturdy gates/doors shall be installed on all enclosures. Gates should not be mounted directly onto the block wall or inside of enclosure. The enclosure should include hardware to secure the gate's doors both open and closed (i.e., cane bolt with sleeve and latch between doors and sleeve in pavement).
- 3) To prevent trash enclosures from contributing to storm water runoff pollution, all enclosures must be fitted with a roof designed to drain into onsite landscape areas (where necessary) and/or to appropriate BMPs. The roof must provide sufficient clearance to allow the dumpster lid to open to the 90-degree position.
- 4) Enclosure roofs not conforming to City specifications for Patio Covers may require a building permit. Generally, roofs not more than 12 feet high above grade and constructed with conventional light-frame wood construction are considered acceptable. The use of metal roofs is not recommended as they can act as a source of pollution.

<http://www.sandiego.gov/development-services/pdf/industry/infobulletin/ib206.pdf>

- 5) Dumpsters associated with food establishments shall be sized per County Health Department requirements for wash down. Drains shall be connected to the business grease interceptor.

E.4 SD-A Tree Well



Tree Wells (Source: County of San Diego LID Manual – EOA, Inc.)

MS4 Permit Category

Site Design

Manual Category

Site Design

Applicable Performance Standard

Site Design

Primary Benefits

Volume Reduction

Description

Trees planted to intercept rainfall and runoff can be used as storm water management measures that provide additional benefits beyond those typically associated with trees, including energy conservation, air quality improvement, and aesthetic enhancement. Typical storm water management benefits associated with trees include:

- **Interception of rainfall** – tree surfaces (roots, foliage, bark, and branches) intercept, evaporate, store, or convey precipitation to the soil before it reaches surrounding impervious surfaces
- **Reduced erosion** – trees protect denuded area by intercepting or reducing the velocity of rain drops as they fall through the tree canopy
- **Increased infiltration** – soil conditions created by roots and fallen leaves promote infiltration
- **Treatment of storm water** – trees provide treatment through uptake of nutrients and other storm water pollutants (phytoremediation) and support of other biological processes that break down pollutants

Typical tree well system components include:

- Trees of the appropriate species for site conditions and constraints
- Available growing space based on tree species, soil type, water availability, surrounding land uses, and project goals

- Optional suspended pavement design to provide structural support for adjacent pavement without requiring compaction of underlying layers
- Optional root barrier devices as needed; a root barrier is a device installed in the ground, between a tree and the sidewalk, intended to guide roots down and away from the sidewalk in order to prevent sidewalk lifting from tree roots.
- Optional tree grates: to be considered to maximize available space for pedestrian circulation and to protect tree roots from compaction related to pedestrian circulation; tree grates are typically made up of porous material that will allow the runoff to soak through.

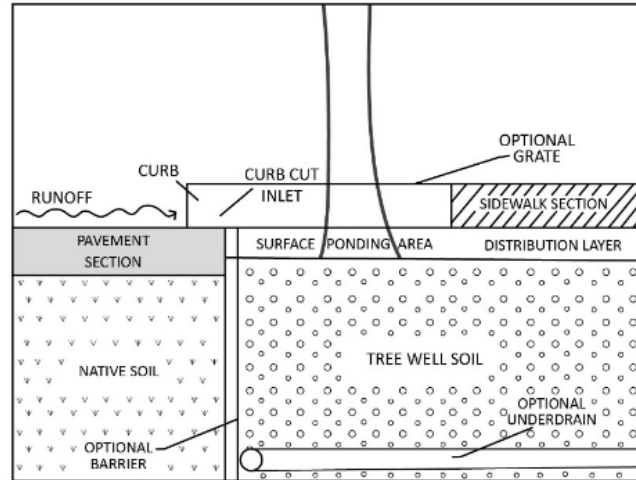

Schematic of Tree Well

- Optional shallow surface depression for ponding of excess runoff
- Optional planter box drain

Design Adaptations for Project Goals

Site design BMP to provide incidental treatment. Tree wells primarily functions as site design BMPs for incidental treatment. Benefits from tree wells are accounted for by adjustment factors presented in Appendix B.2. This credit can apply to non-tree wells as well (that meet the same criteria). Trees as a site design BMP are only credited up to 0.25 times the DCV from the project footprint (with a maximum single tree credit volume of 400 ft³).

Storm water pollutant control BMP to provide treatment. Applicants are allowed to design trees as a pollutant control BMP and obtain credit greater than 0.25 times the DCV from the project footprint (or a credit greater than 400 ft³ from a single tree). For this option to be approved by the Authority, applicant is required to do infiltration feasibility screening (Appendix C and D) and provide calculations supporting the amount of credit claimed from implementing trees within the project footprint. The Authority has the discretion to request additional analysis before approving credits greater than 0.25 times the DCV from the project footprint (or a credit greater than 400 ft³ from a single tree).

Design Criteria and Considerations

Tree wells must meet the following design criteria and considerations. Deviations from the below criteria may be approved at the discretion of the Authority if it is determined to be appropriate:

<i>Siting and Design</i>	<i>Intent/Rationale</i>														
<p><input type="checkbox"/> Tree species is appropriately chosen for the development (private or public). For public rights-of-ways, local planning guidelines and zoning provisions for the permissible species and placement of trees are consulted. A list of trees appropriate for site design that can be used by all county municipalities are provided in Appendix E.23</p>	<p>Proper tree placement and species selection minimizes problems such as pavement damage by surface roots and poor growth.</p>														
<p><input type="checkbox"/> Location of trees planted along public streets follows local requirements and guidelines. Vehicle and pedestrian line of sight are considered in tree selection and placement. Unless exemption is granted by the Authority the following minimum tree separation distance is followed</p>	<p>Roadway safety for both vehicular and pedestrian traffic is a key consideration for placement along public streets.</p>														
<table border="1"> <thead> <tr> <th data-bbox="297 774 683 894">Improvement</th> <th data-bbox="683 774 859 894">Minimum distance to Tree Well</th> </tr> </thead> <tbody> <tr> <td data-bbox="297 894 683 932">Traffic Signal, Stop sign</td> <td data-bbox="683 894 859 932">20 feet</td> </tr> <tr> <td data-bbox="297 932 683 1003">Underground Utility lines (except sewer)</td> <td data-bbox="683 932 859 1003">5 feet</td> </tr> <tr> <td data-bbox="297 1003 683 1041">Sewer Lines</td> <td data-bbox="683 1003 859 1041">10 feet</td> </tr> <tr> <td data-bbox="297 1041 683 1150">Above ground utility structures (Transformers, Hydrants, Utility poles, etc.)</td> <td data-bbox="683 1041 859 1150">10 feet</td> </tr> <tr> <td data-bbox="297 1150 683 1188">Driveways</td> <td data-bbox="683 1150 859 1188">10 feet</td> </tr> <tr> <td data-bbox="297 1188 683 1262">Intersections (intersecting curb lines of two streets)</td> <td data-bbox="683 1188 859 1262">25 feet</td> </tr> </tbody> </table>	Improvement	Minimum distance to Tree Well	Traffic Signal, Stop sign	20 feet	Underground Utility lines (except sewer)	5 feet	Sewer Lines	10 feet	Above ground utility structures (Transformers, Hydrants, Utility poles, etc.)	10 feet	Driveways	10 feet	Intersections (intersecting curb lines of two streets)	25 feet	
Improvement	Minimum distance to Tree Well														
Traffic Signal, Stop sign	20 feet														
Underground Utility lines (except sewer)	5 feet														
Sewer Lines	10 feet														
Above ground utility structures (Transformers, Hydrants, Utility poles, etc.)	10 feet														
Driveways	10 feet														
Intersections (intersecting curb lines of two streets)	25 feet														
<p><input type="checkbox"/> Underground utilities and overhead wires are considered in the design and avoided or circumvented. Underground utilities are routed around or through the planter in suspended pavement applications. All underground utilities are protected from water and root penetration.</p>	<p>Tree growth can damage utilities and overhead wires resulting in service interruptions. Protecting utilities routed through the planter prevents damage and service interruptions.</p>														
<p><input type="checkbox"/> Suspended pavement design was developed where appropriate to minimize soil compaction and improve infiltration and filtration capabilities. Suspended pavement was constructed with an approved structural cell.</p>	<p>Suspended pavement designs provide structural support without compaction of the underlying layers, thereby promoting tree growth. Recommended structural cells include poured in place concrete columns, Silva Cells manufactured by Deeproot Green Infrastructures and Stratacell and Stratavault systems manufactured by Citygreen Systems.</p>														

<i>Siting and Design</i>	<i>Intent/Rationale</i>
<p><input type="checkbox"/> A minimum soil volume of 2 ft³ per square foot of canopy projection volume is provided for each tree. Canopy projection area is the ground area beneath the tree, measured at the drip line.</p>	<p>The minimum soil volume ensures that there is adequate storage volume to allow for unrestricted evapotranspiration. A lower amount of soil volume may be allowed at the discretion of the Authority if certified by a landscape architect or agronomist. The retention credit from the tree is directly proportional to the soil volume provided for the tree.</p>
<p><input type="checkbox"/> DCV from the tributary area draining to the tree is equal to or greater than the tree credit volume</p>	<p>The minimum tributary area ensures that the tree receives enough runoff to fully utilize the infiltration and evapotranspiration potential provided. In cases where the minimum tributary area is not provided, the tree credit volume must be reduced proportionately to the actual tributary area.</p>
<p><input type="checkbox"/> Inlet opening to the tree that is at least 18 inches wide. A minimum 2-inch drop in grade from the inlet to the finish grade of the tree. Grated inlets are allowed for pedestrian circulation. Grates need to be ADA compliant and have sufficient slip resistance.</p>	<p>Design requirement to ensure that the runoff from the tributary area is not bypassed. Different inlet openings and drops in grade may be allowed at the discretion of the Authority if calculations are shown that the diversion flow rate (Appendix B.1.2) from the tributary area can be conveyed to the tree. In cases where the inlet capacity is limiting the amount of runoff draining to the tree, the tree credit volume must be reduced proportionately.</p>

Conceptual Design and Sizing Approach for Site Design

- 1) Determine the areas where tree wells can be used in the site design to achieve incidental treatment. Tree wells reduce runoff volumes from the site. Refer to Appendix B.2. Document the proposed tree locations in the SWQMP.
- 2) When trees are proposed as a storm water pollutant control BMP, applicant must complete feasibility analysis in Appendix C and D and submit detailed calculations for the DCV treated by trees. Document the proposed tree locations, feasibility analysis and sizing calculations in the SWQMP. The following calculations should be performed and the smallest of the three should be used as the volume treated by trees:
 - (a) Delineate the DMA (tributary area) to the tree and calculate the associated DCV.

- (b) Calculate the required diversion flow rate using Appendix B.1.2 and size the inlet required to convey this flow rate to the tree. If the proposed inlet cannot convey the diversion flow rate for the entire tributary area, then the DCV that enters the tree should be proportionally reduced.
 - i. For example, 0.5-acre drains to the tree and the associated DCV is 820 ft³. The required diversion flow rate is 0.10 ft³/s, but only an inlet that can divert 0.05 ft³/s could be installed.
 - ii. Then the effective DCV draining to the tree = $820 \text{ ft}^3 * (0.05/0.10) = 420 \text{ ft}^3$
- (c) Estimate the amount of storm water treated by the tree by summing the following:
 - i. Evapotranspiration credit of 0.1 * amount of soil volume installed; and
 - ii. Infiltration credit calculated using sizing procedures in Appendix B.4.

Maintenance Overview

Normal Expected Maintenance. Tree health shall be maintained as part of normal landscape maintenance. Additionally, ensure that storm water runoff can be conveyed into the tree well as designed. That is, the opening that allows storm water runoff to flow into the tree well (e.g., a curb opening, tree grate, or surface depression) shall not be blocked, filled, re-graded, or otherwise changed in a manner that prevents storm water from draining into the tree well. A summary table of standard inspection and maintenance indicators is provided within the Fact Sheet

Non-Standard Maintenance or BMP Failure. Tree wells are site design BMPs that normally do not require maintenance actions beyond routine landscape maintenance. The normal expected maintenance described above ensures the BMP functionality. If changes have been made to the tree well entrance/opening such that runoff is prevented from draining into the tree well (e.g., a curb inlet opening is clogged by debris or a grate is clogged causing runoff to flow around instead of into the tree well, or a surface depression has been filled so runoff flows away from the tree well), the BMP is not performing as intended to protect downstream waterways from pollution and/or erosion. Corrective maintenance will be required to restore drainage into the tree well as designed.

Surface ponding of runoff directed into tree wells is expected to infiltrate/evapotranspire within 24 to 96 hours following a storm event. Surface ponding longer than approximately 24 hours following a storm event may be detrimental to vegetation health, and surface ponding longer than approximately 96 hours following a storm event poses a risk of vector (mosquito) breeding. Poor drainage can result from clogging or compaction of the soils surrounding the tree. Loosen or replace the soils to restore drainage.

Other Special Considerations. Site design BMPs, such as tree wells, installed within a new development or redevelopment project are components of an overall storm water management strategy for the project. The presence of site design BMPs within a project is usually a factor in the determination of the amount of runoff to be managed within structural BMPs (i.e., the amount of runoff expected to reach downstream retention or biofiltration basins that process storm water runoff from the project as a whole). When site design BMPs are not maintained or are removed, clogging or failure of downstream structural BMPs can result because of greater delivery of runoff and pollutants than intended for the structural BMP. Therefore, the Authority may require confirmation of

Appendix E: BMP Design Fact Sheets

maintenance of site design BMPs as part of their structural BMP maintenance documentation requirements. Site design BMPs that have been installed as part of the project should not be removed, nor should they be bypassed by re-routing roof drains or re-grading surfaces within the project. If changes are necessary, consult the Authority to determine requirements.

Summary of Standard Inspection and Maintenance

The property owner is responsible to ensure inspection, operation and maintenance of permanent BMPs on their property unless responsibility has been formally transferred to the Authority.

Maintenance frequencies listed in this table are average/typical frequencies. Actual maintenance needs are site-specific, and maintenance may be required more frequently. Maintenance must be performed whenever needed, based on maintenance indicators presented in this table. The BMP owner is responsible for conducting regular inspections to see when maintenance is needed based on the maintenance indicators. During the first year of operation of a structural BMP, inspection is recommended at least once prior to August 31 and then monthly from September through May. Inspection during a storm event is also recommended. After the initial period of frequent inspections, the minimum inspection and maintenance frequency can be determined based on the results of the first-year inspections.

Threshold/Indicator	Maintenance Action	Typical Maintenance Frequency
Tree health	Routine actions as necessary to maintain tree health.	<ul style="list-style-type: none"> Inspect monthly. Maintain when needed.
Dead or diseased tree	Remove dead or diseased tree. Replace per original plans.	<ul style="list-style-type: none"> Inspect monthly. Maintain when needed.
Standing water in tree well for longer than 24 hours following a storm event Surface ponding longer than approximately 24 hours following a storm event may be detrimental to tree health	Loosen or replace soils surrounding the tree to restore drainage.	<ul style="list-style-type: none"> Inspect monthly and after every 0.5-inch or larger storm event. If standing water is observed, increase inspection frequency to after every 0.1-inch or larger storm event. Maintain when needed.
Presence of mosquitos/larvae For images of egg rafts, larva, pupa, and adult mosquitos, see http://www.mosquito.org/biology	Disperse any standing water from the tree well to nearby landscaping. Loosen or replace soils surrounding the tree to restore drainage (and prevent standing water).	<ul style="list-style-type: none"> Inspect monthly and after every 0.5-inch or larger storm event. If mosquitos are observed, increase inspection frequency to after 0.1-inch or larger storm event. Maintain when needed

Threshold/Indicator	Maintenance Action	Typical Maintenance Frequency
<p>Entrance/opening to the tree well is blocked such that storm water will not drain into the tree well (e.g., a curb inlet opening is blocked by debris, or a grate is clogged causing runoff to flow around instead of into the tree well; or a surface depression is filled such that runoff drains away from the tree well)</p>	<p>Make repairs as appropriate to restore drainage into the tree well.</p>	<ul style="list-style-type: none"> • Inspect monthly. • Maintain when needed.

E.5 SD-B Impervious Area Dispersion



Photo Credit: Orange County Technical Guidance Document

MS4 Permit Category

Site Design

Manual Category

Site Design

Applicable Performance Criteria

Site Design

Primary Benefits

Volume Reduction

Peak Flow Attenuation

Description

Impervious area dispersion (dispersion) refers to the practice of effectively disconnecting impervious areas from directly draining to the storm drain system by routing runoff from impervious areas such as rooftops (through downspout disconnection), walkways, and driveways onto the surface of adjacent pervious areas. The intent is to slow runoff discharges and reduce volumes. Dispersion with partial or full infiltration results in significant volume reduction by means of infiltration and evapotranspiration.

Typical dispersion components include:

- An impervious surface from which runoff flows will be routed with minimal piping to limit concentrated inflows
- Splash blocks, flow spreaders, or other means of dispersing concentrated flows and providing energy dissipation as needed
- Dedicated pervious area, typically vegetated, with in situ soil infiltration capacity for partial or full infiltration
- Optional soil amendments to improve vegetation support, maintain infiltration rates and enhance treatment of routed flows
- Overflow route for excess flows to be conveyed from dispersion area to the storm drain system or discharge point

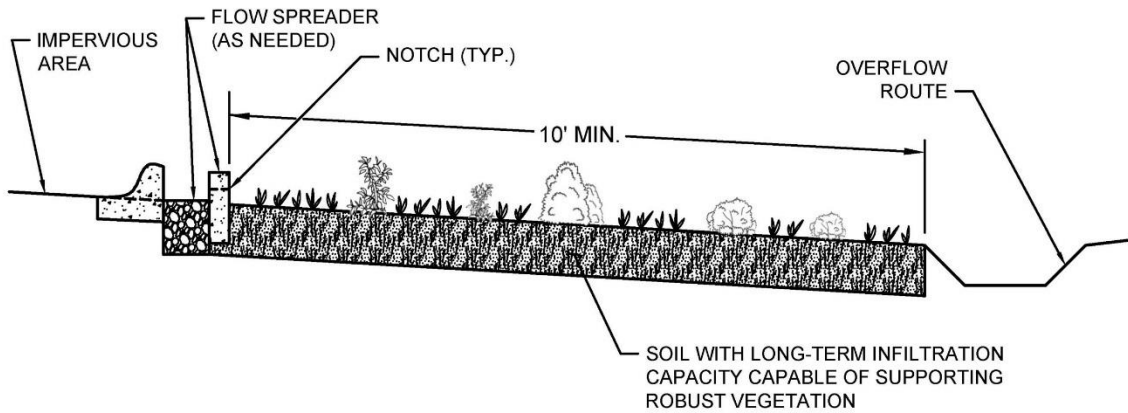
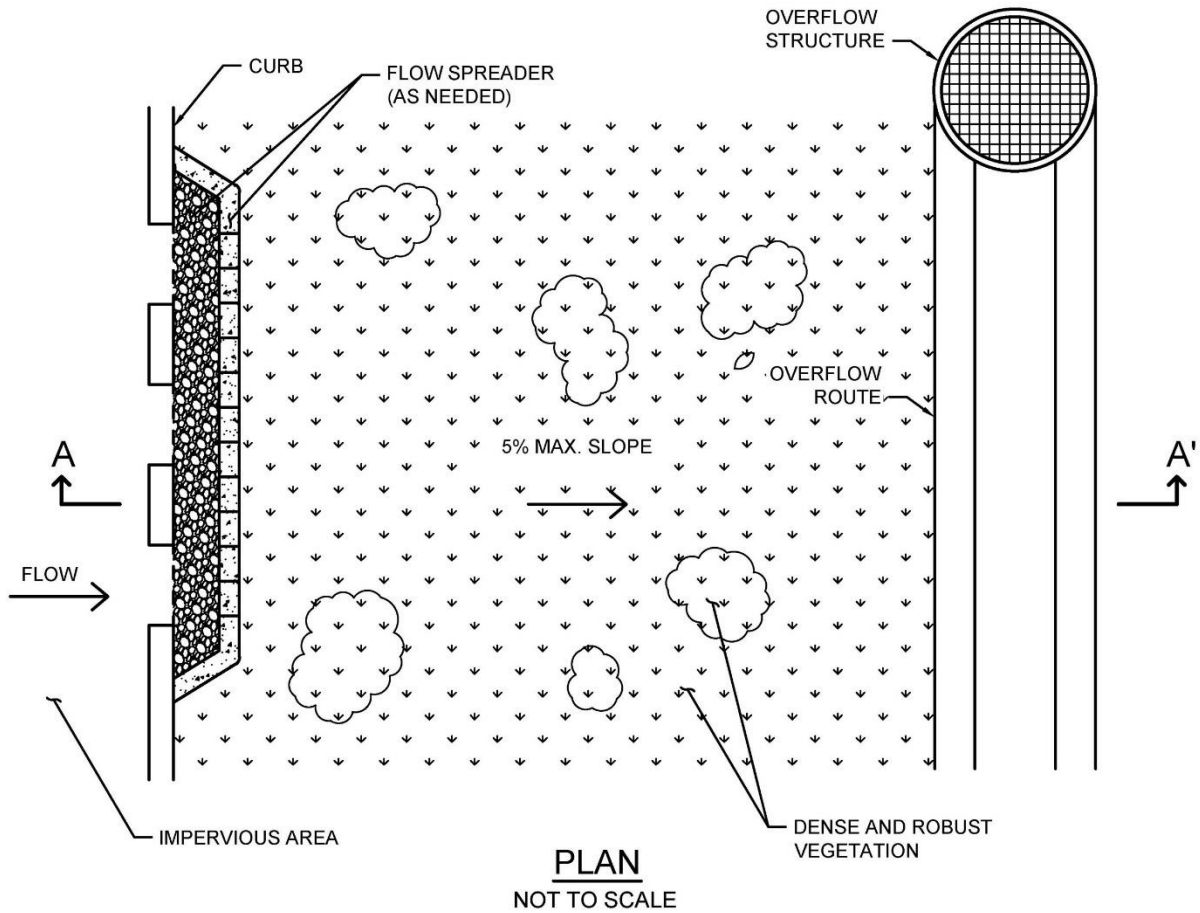

Typical Plan and Section View of an Impervious Area Dispersion BMP

Design Adaptations for Project Goals

Site design BMP to reduce impervious area and DCV. Impervious area dispersion primarily functions as a site design BMP for reducing the effective imperviousness of a site by providing partial or full infiltration of the flows that are routed to pervious dispersion areas and otherwise slowing down excess flows that eventually reach the storm drain system. This can significantly reduce the DCV for the site.

Design Criteria and Considerations

Dispersion must meet the following design criteria. Deviations from the below criteria may be approved at the discretion of the Authority if it is determined to be appropriate:

<i>Siting and Design</i>	<i>Intent/Rationale</i>
<input type="checkbox"/> Dispersion is over areas with soil types capable of supporting or being amended (e.g., with sand or compost) to support vegetation. Media amendments must be tested to verify that they are not a source of pollutants.	Soil must have long-term infiltration capacity for partial or full infiltration and be able to support vegetation to provide runoff treatment. Amendments to improve plant growth must not have negative impact on water quality.
<input type="checkbox"/> Dispersion has vegetated sheet flow over a relatively large distance (minimum 10 feet) from inflow to overflow route.	Full or partial infiltration requires relatively large areas to be effective depending on the permeability of the underlying soils.
<input type="checkbox"/> Pervious areas should be flat (with less than 5% slopes) and vegetated.	Flat slopes facilitate sheet flows and minimize velocities, thereby improving treatment and reducing the likelihood of erosion.
<i>Inflow velocities</i>	
<input type="checkbox"/> Inflow velocities are limited to 3 ft/s or less or use energy dissipation methods (e.g., riprap, level spreader) for concentrated inflows.	High inflow velocities can cause erosion, scour and/or channeling.
<i>Dedication</i>	
<input type="checkbox"/> Dispersion areas must be owned by the project owner and be dedicated for the purposes of dispersion to the exclusion of other future uses that might reduce the effectiveness of the dispersion area.	Dedicated dispersion areas prevent future conversion to alternate uses and facilitate continued full and partial infiltration benefits.
<i>Vegetation</i>	
<input type="checkbox"/> Dispersion typically requires dense and robust vegetation for proper function. Drought tolerant species should be selected to minimize irrigation needs. A plant list to aid in selection can be found in Appendix E.23.	Vegetation improves resistance to erosion and aids in runoff treatment.

Conceptual Design and Sizing Approach for Site Design

- 1) Determine the areas where dispersion can be used in the site design to reduce the DCV for pollutant control sizing.
- 2) Calculate the DCV for storm water pollutant control per Appendix B.2, taking into account reduced runoff from dispersion.
- 3) Determine whether a DMA is considered “Self-retaining” if the impervious to pervious ratio is:
 - (a) 2:1 when the pervious area is composed of Hydrologic Soil Group A
 - (b) 1:1 when the pervious area is composed of Hydrologic Soil Group B

Conceptual Design and Sizing Approach for Storm Water Pollutant Treatment

DMA's using impervious area dispersion are considered to meet pollutant control if ALL of the following criteria are met:

- 1) All impervious area within the DMA discharges to the pervious area before the runoff discharges from the DMA.
- 2) As a minimum, the pervious area meets the requirements for dispersion (e.g., slope, inflow velocities, etc.) in SD-B fact sheet.
- 3) The impervious to pervious area ration is 1:1 or less.

Maintenance Overview

Normal Expected Maintenance. Vegetated areas shall be maintained as part of normal landscape maintenance. Additionally, ensure that storm water runoff can be conveyed into the vegetated area as designed. That is, the mechanism that allows storm water runoff from impervious area to flow into the pervious area (e.g., a curb cut allows runoff from a parking lot to drain onto adjacent landscaping area, or a roof drain outlet is directed to a lawn) shall not be removed, blocked, filled, or otherwise changed in a manner that prevents storm water from draining into the pervious area. A summary table of standard inspection and maintenance indicators is provided within this Fact Sheet.

Non-Standard Maintenance or BMP Failure. Impervious area dispersion is a site design BMP that normally does not require maintenance actions beyond routine landscape maintenance. If changes have been made to the area, such as the vegetated area has been replaced with impervious area, or the mechanism that allows storm water runoff from impervious area to flow into the pervious area has been removed (e.g., roof drains previously directed to vegetated area have been directly connected to the street or storm drain system), the BMP is not performing as intended to protect downstream waterways from pollution. Corrective maintenance will be required to restore drainage into the pervious area as designed. If the pervious area has been removed, contact the Authority to determine a solution.

Runoff directed into vegetated areas is expected to be drained within 24-96 hours following a storm event. Surface ponding longer than approximately 24 hours following a storm event may be detrimental to vegetation health, and surface ponding longer than approximately 96 hours following

Appendix E: BMP Design Fact Sheets

a storm event poses a risk of vector (mosquito) breeding. Poor drainage can result from clogging or compaction of the soils. Loosen or replace the soils to restore drainage.

Other Special Considerations. Site design BMPs, such as impervious area dispersion, installed within a new development or redevelopment project are components of an overall storm water management strategy for the project. The presence of site design BMPs within a project is usually a factor in the determination of the amount of runoff to be managed with structural BMPs (i.e., the amount of runoff expected to reach downstream retention or bioretention basins that process storm water runoff from the project as a whole). When site design BMPs are not maintained or are removed, clogging or failure of downstream structural BMPs can result because of the greater delivery of runoff and pollutants than intended for the structural BMP. Therefore, the Authority may require confirmation of maintenance of site design BMPs as part of their structural BMP maintenance documentation requirements. Site design BMPs that have been installed as part of the project should not be removed, nor should they be bypassed by re-routing runoff drains or re-grading surfaces within the project. If changes are necessary, consult the Authority to determine requirements.

This page intentionally left blank

Summary of Standard Inspection and Maintenance

The property owner is responsible to ensure inspection, operation and maintenance of permanent BMPs on their property unless responsibility has been formally transferred to the Authority.

Maintenance frequencies listed in this table are average/typical frequencies. Actual maintenance needs are site-specific, and maintenance may be required more frequently. Maintenance must be performed whenever needed, based on maintenance indicators presented in this table. The BMP owner is responsible for conducting regular inspections to see when maintenance is needed based on the maintenance indicators. During the first year of operation of a structural BMP, inspection is recommended at least once prior to August 31 and then monthly from September through May. Inspection during a storm event is also recommended. After the initial period of frequent inspections, the minimum inspection and maintenance frequency can be determined based on the results of the first-year inspections.

Threshold/Indicator	Maintenance Action	Typical Maintenance Frequency
Poor vegetation establishment	Re-seed, re-plant, or re-establish vegetation per original plans.	<ul style="list-style-type: none"> • Inspect monthly. • Maintain when needed.
Dead or diseased vegetation	Remove dead or diseased vegetation, re-seed, re-plant, or re-establish vegetation per original plans.	<ul style="list-style-type: none"> • Inspect monthly. • Maintain when needed.
Standing water in vegetated pervious area for longer than 24 hours following a storm event Surface ponding longer than approximately 24 hours following a storm event may be detrimental to vegetation health	Disperse any areas of standing water to nearby landscaping (i.e., spread it out to another portion of the pervious area so it drains into the soil). Make appropriate corrective measures such as adjusting irrigation system or repairing/replacing clogged or compacted soils.	<ul style="list-style-type: none"> • Inspect monthly and after every 0.5-inch or larger storm event. If standing water is observed, increase inspection frequency to after every 0.1-inch or larger storm event. • Maintain when needed.
Presence of mosquitos/larvae For images of egg rafts, larva, pupa, and adult mosquitos, see https://www.mosquito.org/biology	Disperse any areas of standing water to nearby landscaping (i.e., spread it out to another portion of the pervious area so it drains into the soil). Loosen or replace the soils to resort drainage (and prevent standing water).	<ul style="list-style-type: none"> • Inspect monthly and after every 0.5-inch or larger storm event. If standing water is observed, increase inspection frequency to after every 0.1-inch or larger storm event. • Maintain when needed.

Threshold/Indicator	Maintenance Action	Typical Maintenance Frequency
Entrance/opening to the vegetated pervious area is blocked such that storm water from impervious area will not drain into the pervious area (e.g., a curb cut opening is blocked by debris or a roof drain outlet has been directly connected to the storm drain system)	Make repairs as appropriate to restore drainage into the vegetated pervious area.	<ul style="list-style-type: none"> • Inspect monthly. • Maintain when needed.

E.6 SD-C: Green Roofs



Location: County of San Diego Operations Center, San Diego, California

MS4 Permit Category

Site Design

Manual Category

Site Design

Applicable Performance Standard

Site Design

Primary Benefits

Volume Reduction
Peak Flow Attenuation

Description

Green roofs are vegetated rooftop systems that reduce runoff volumes and rates, treat storm water pollutants through filtration and plant uptake, provide additional landscape amenity, and create wildlife habitat. Additionally, green roofs reduce the heat island effect and provide acoustical control, air filtration and oxygen production. In terms of building design, they can protect against ultraviolet rays and extend the roof lifetime, as well as increase the building insulation, thereby decreasing heating and cooling costs. When considering green roofs as a structural BMP for implementation, all FAA Advisory Circulars (ACs) and FAA guidance/restrictions must be adhered to. There are two primary types of green roofs:

- **Extensive** – lightweight, low maintenance system with low-profile, drought tolerant type groundcover in shallow growing medium (6 inches or less)
- **Intensive** – heavyweight, high maintenance system with a more garden-like configuration and diverse plantings that may include shrubs or trees in a thicker growing medium (greater than 6 inches)

Typical green roof components include, from top to bottom:

- Vegetation that is appropriate to the type of green roof system, climate, and watering conditions
- Media layer (planting mix or engineered media) capable of supporting vegetation growth

- Filter fabric to prevent migration of fines (soils) into the drainage layer
- Optional drainage layer to convey excess runoff
- Optional root barrier
- Optional insulation layer
- Waterproof membrane
- Structural roof support capable of withstanding the additional weight of a green roof

Because SAN is an active airport, additional design considerations include:

- Minimizing animal attractants to prevent bird strikes
- Maintaining height restrictions
- Preventing the release of organic foreign object debris (FOD)

O'Hare International Airport has successfully installed green roofs on 12 facilities. Additional references for airport-specific installation, including plant species recommendations, can be found at <http://www.flychicago.com/OHare/EN/AboutUs/Sustainability/Vegetated-Roofs.aspx>. A landscape architect should be consulted to identify climate-specific species that meet the necessary restrictions for airport design.

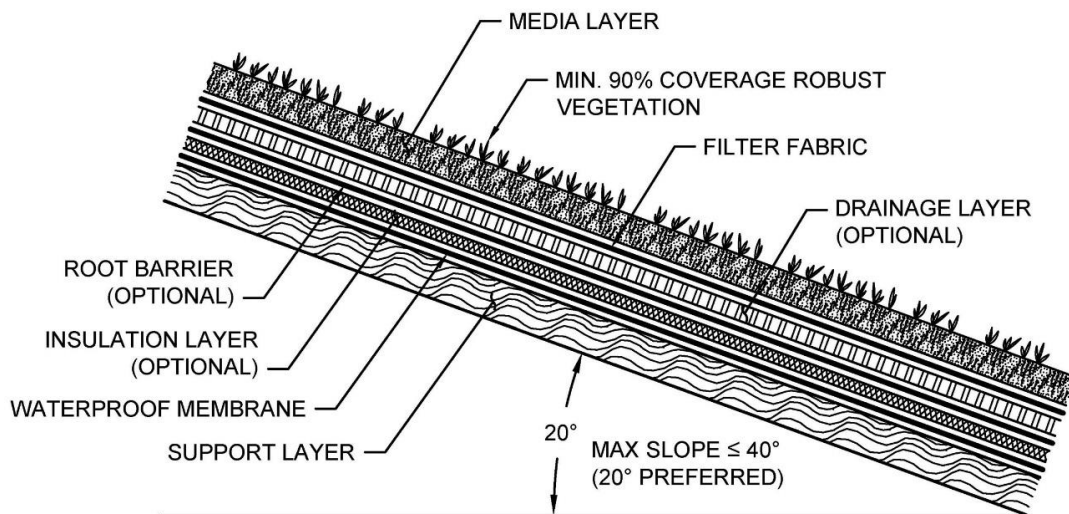

PROFILE
NOT TO SCALE

Typical Profile of a Green Roof BMP

Design Adaptations for Project Goals

Site design BMP to provide incidental treatment. Green roofs can be used as a site design feature to reduce the impervious area of the site through replacing conventional roofing. This can reduce the DCV and flow control requirements for the site.

Design Criteria and Considerations

Green roofs must meet the following design criteria. Deviations from the below criteria may be approved at the discretion of the Authority if it is determined to be appropriate:

<i>Siting and Design</i>	<i>Intent/Rationale</i>
<input type="checkbox"/> Roof slope is $\leq 40\%$ (Roofs that are $\leq 20\%$ are preferred).	Steep roof slopes increase project complexity and requires supplemental anchoring.
<input type="checkbox"/> Structural roof capacity design supports the calculated additional load (pounds/ft ²) of the vegetation growing medium and additional drainage and barrier layers.	Inadequate structural capacity increases the risk for roof failure and harm to the building and occupants.
<input type="checkbox"/> Design and construction are planned to be completed by an experienced green roof specialist.	A green roof specialist will minimize complications in implementation and potential structural issues that are critical to green roof success.
<input type="checkbox"/> Green roof location and extent must meet fire safety provisions.	Green roof design must not negatively impact fire safety.
<input type="checkbox"/> Maintenance access is included in the green roof design.	Maintenance will facilitate proper functioning of drainage and irrigation components and allow for removal of undesirable vegetation and soil testing, as needed.
<input type="checkbox"/> Green roof location will not violate airport building height restrictions.	Green roof design must not interfere with airport operation.
Vegetation	
<input type="checkbox"/> Vegetation is suitable for the green roof type, climate and expected watering conditions. Perennial, self-sowing plants that are drought-tolerant (e.g., sedums, succulents) and require little to no fertilizer, pesticides or herbicides are recommended. Vegetation pre-grown at grade may allow plants to establish prior to facing harsh roof conditions.	Plants suited to the design and expected growing environment are more likely to survive.
<input type="checkbox"/> Vegetation is capable of covering $\geq 90\%$ the roof surface.	Benefits of green roofs are greater with more surface vegetation.

<i>Siting and Design</i>	<i>Intent/Rationale</i>
<input type="checkbox"/> Vegetation is robust and erosion-resistant in order to withstand the anticipated rooftop environment (e.g., heat, cold, high winds).	Weak plants will not survive in extreme rooftop environments.
<input type="checkbox"/> Vegetation is fire resistant.	Vegetation that will not burn easily decreases the chance for fire and harm to the building and occupants.
<input type="checkbox"/> Vegetation considers roof sun exposure and shaded areas based on roof slope and location.	The amount of sunlight the vegetation receives can inhibit growth therefore the beneficial effects of a vegetated roof.
<input type="checkbox"/> Vegetation is unattractive for animal food production and species habitat.	Minimizing animal attraction is necessary to avoid bird strikes and maintain safety.
<input type="checkbox"/> Vegetation is highly durable and wind resistant.	Plant fragility may increase FOD and compromise safety.
<input type="checkbox"/> An irrigation system (e.g., drip irrigation system) is included as necessary to maintain vegetation.	Proper watering will increase plant survival, especially for new plantings.
<input type="checkbox"/> Media is well-drained and is the appropriate depth required for the green roof type and vegetation supported.	Unnecessary water retention increases structural loading. An adequate media depth increases plant survival.
<input type="checkbox"/> A filter fabric is used to prevent migration of media fines through the system.	Migration of media can cause clogging of the drainage layer.
<input type="checkbox"/> A drainage layer is provided if needed to convey runoff safely from the roof. The drainage layer can be comprised of gravel, perforated sheeting, or other drainage materials.	Inadequate drainage increases structural loading and the risk of harm to the building and occupants.
<input type="checkbox"/> A root barrier comprised of dense material to inhibit root penetration is used if the waterproof membrane will not provide root penetration protection.	Root penetration can decrease the integrity of the underlying structural roof components and increase the risk of harm to the building and occupants.
<input type="checkbox"/> An insulation layer is included as needed to protect against the water in the drainage layer from extracting building heat in the winter and cool air in the summer.	Regulating thermal impacts of green roofs will aid in controlling building heating and cooling costs.
<input type="checkbox"/> A waterproof membrane is used to prevent the roof runoff from vertically migrating and damaging the roofing material. A root barrier may be required to prevent roots from compromising the integrity of the membrane.	Water-damaged roof materials increase the risk of harm to the building and occupants.

Conceptual Design and Sizing Approach for Site Design

- 1) Determine the areas where green roofs can be used in the site design to replace conventional roofing to reduce the DCV. These green roof areas can be credited toward reducing runoff generated through representation in storm water calculations as pervious, not impervious, areas but are not credited for storm water pollutant control.
- 2) Calculate the DCV per Appendix B.2.

Maintenance Overview

Normal Expected Maintenance. A green roof requires routine maintenance to: maintain vegetation health; and maintain integrity of the roof drainage system. A summary table of standard inspection and maintenance indicators is provided within this Fact Sheet.

Non-Standard Maintenance or BMP Failure. Green roofs are site design BMPs that normally do not require maintenance actions beyond the normal maintenance described above. If a roof leak is discovered, it may be an indicator that the waterproof membrane has failed. The waterproof membrane (roof liner) shall be inspected and repaired or replaced as necessary.

Green roof systems normally receive only direct rainfall (not runoff from additional tributary area directed into the system). It is expected to be drained within 24-96 hours following a storm event. Surface ponding longer than approximately 24 hours following a storm event may be detrimental to vegetation health, and surface ponding longer than approximately 96 hours following a storm event poses a risk of vector (mosquito) breeding, as well as risk of damage to the roof. Poor drainage can result from clogging or compaction of the media, optional drainage layer, or drainage system. The specific cause of the drainage issue must be determined and corrected.

Other Special Considerations. Site design BMPs, such as green roofs, installed within a new development or redevelopment project are components of an overall storm water management strategy for the project. The presence of site design BMPs within a project is usually a factor in the determination of the amount of runoff to be managed with structural BMPs (i.e., the amount of runoff expected to reach downstream retention or biofiltration basins that process storm water runoff from the project as a whole). When site design BMPs are not maintained or are removed, clogging or failure of downstream structural BMPs can result because of greater delivery of runoff and pollutants than intended for the structural BMP. Therefore, the Authority may require confirmation of maintenance of site design BMPs as part of their structural BMP maintenance documentation requirements. Site design BMPs that have been installed as part of the project should not be removed, nor should they be bypassed by re-routing roof drains or re-grading surfaces within the project. If changes are necessary, consult the Authority to determine requirements.

This page intentionally left blank

Summary of Standard Inspection and Maintenance

The property owner is responsible to ensure inspection, operation and maintenance of permanent BMPs on their property unless responsibility has been formally transferred to the Authority.

Maintenance frequencies listed in this table are average/typical frequencies. Actual maintenance needs are site-specific, and maintenance may be required more frequently. Maintenance must be performed whenever needed, based on maintenance indicators presented in this table. The BMP owner is responsible for conducting regular inspections to see when maintenance is needed based on the maintenance indicators. During the first year of operation of a structural BMP, inspection is recommended at least once prior to August 31 and then monthly from September through May. Inspection during a storm event is also recommended. After the initial period of frequent inspections, the minimum inspection and maintenance frequency can be determined based on the results of the first-year inspections.

Threshold/Indicator	Maintenance Action	Typical Maintenance Frequency
Poor vegetation establishment	Re-seed, re-plant, or re-establish vegetation per original plans.	<ul style="list-style-type: none"> Inspect monthly. Maintain when needed.
Dead or diseased vegetation	Remove dead or diseased vegetation, re-seed, re-plant, or re-establish vegetation per original plans.	<ul style="list-style-type: none"> Inspect monthly. Maintain when needed.
Overgrown vegetation	Mow or trim as appropriate.	<ul style="list-style-type: none"> Inspect monthly. Maintain when needed.
Standing water in BMP for longer than 24 hours following a storm event Surface ponding longer than approximately 24 hours following a storm event may be detrimental to vegetation health	Disperse any areas of standing water to nearby landscaping (i.e., spread it out to another portion of the green roof so it drains into the soil). Make appropriate corrective measures such as adjusting irrigation system, clearing underdrains, or repairing/replacing clogged or compacted soils.	<ul style="list-style-type: none"> Inspect monthly and after every 0.5-inch or larger storm event. If standing water is observed, increase inspection frequency to after every 0.1-inch or larger storm event. Maintain when needed.

Appendix E: BMP Design Fact Sheets

Threshold/Indicator	Maintenance Action	Typical Maintenance Frequency
Presence of mosquitos/larvae For images of egg rafts, larva, pupa, and adult mosquitos, see http://www.mosquito.org/biology	Disperse any areas of standing water to nearby landscaping (i.e., spread it out to another portion of the green roof so it drains into the soil). Loosen or replace soils to restore drainage (and prevent standing water).	<ul style="list-style-type: none"> • Inspect monthly and after every 0.5-inch or larger storm event. If mosquitos are observed, increase inspection frequency to after every 0.1-inch or larger storm event. • Maintain when needed
Leaks or other damage to waterproof membrane	Repair or replace as applicable.	<ul style="list-style-type: none"> • Inspect membrane if leak is observed. • Maintain when needed.

E.7 SD-D Permeable Pavement (Site Design BMP)



Photo Credit: San Diego Low Impact Development Design Manual

MS4 Permit Category

Site Design

Manual Category

Site Design

Applicable Performance Criteria

Site Design

Primary Benefits

Description

Permeable pavement is pavement that allows for percolation through void spaces in the pavement surface into subsurface layers. Permeable pavements reduce runoff volumes and rates and can provide pollutant control via infiltration, filtration, sorption, sedimentation, and biodegradation processes. When used as a site design BMP, the subsurface layers are designed to provide storage of storm water runoff so that outflow rates can be controlled via infiltration into subgrade soils. Varying levels of storm water treatment and flow control can be provided depending on the size of the permeable pavement system relative to its drainage area and the underlying infiltration rates. As site design BMP permeable pavement areas are designed to be self-retaining and are designed primarily for direct rainfall. Self-retaining permeable pavement areas have a ratio of total drainage area (including permeable pavement) to area of permeable pavement of 1.5:1 or less. Permeable pavement surfaces can be constructed from modular paver units or paver blocks, pervious concrete, porous asphalt, and turf pavers. Sites designed with permeable pavements can significantly reduce the impervious area of the project. Reduction in impervious surfaces decreases the DCV and can reduce the footprint of treatment control and flow control BMPs.

Typical Permeable Pavement Components (Top to Bottom)
Permeable surface layer
Bedding layer for permeable surface
Aggregate storage layer with optional underdrain(s)
Optional final filter course layer over uncompacted existing subgrade

Design Adaptations for Project Goals

Site design BMP to reduce impervious area and DCV. Permeable pavement without an underdrain can be used as a site design feature to reduce the impervious area of the site by replacing traditional pavements, including roadways, parking lots, emergency access lanes, sidewalks, trails and driveways.

- 1) Conceptual Design and Sizing Approach for Site Design
- 2) Determine the areas where permeable pavements can be used in the site design to replace conventional pavements to reduce the DCV. These areas can be credited toward reducing runoff generated through representation in storm water calculations as pervious, not impervious, areas but are not credited for storm water pollutant control.
- 3) Calculate the DCV per Appendix B.2, taking into account reduced runoff from permeable pavement areas.

Maintenance Overview

Normal Expected Maintenance. Routine maintenance of permeable pavement includes: removal of materials such as trash and debris accumulated on the paving surface; vacuuming of the paving surface to prevent clogging; and flushing paving and subsurface gravel to remove fine sediment. If the BMP includes underdrains, check and clear underdrains. A summary table of standard inspection and maintenance indicators is provided within this Fact Sheet.

Non-Standard Maintenance or BMP Failure. If the permeable pavement area is not drained between storm events, or if runoff sheet flows across the permeable pavement area and flows off the permeable pavement area during storm events, the BMP is not performing as intended to protect downstream waterways from pollution and/or erosion. During storm events up to the 85th percentile storm event (approximately 0.5 to 1 inch of rainfall in San Diego County), runoff should not flow off the permeable pavement area. The permeable pavement area is expected to have adequate hydraulic conductivity and storage such that rainfall landing on the permeable pavement and runoff from the surrounding drainage area will go directly into the pavement without ponding or overflow (in properly designed systems, the surrounding drainage area is not more than half as large as the permeable pavement area). Following the storm event, there should be no standing water (puddles) on the permeable pavement area.

If storm water is flowing off the permeable pavement during a storm event, or if there is standing water on the permeable pavement surface following a storm event, this is an indicator of clogging somewhere within the system. Poor drainage can result from clogging of the permeable surface layer, any of the subsurface components, or the subgrade soils. The specific cause of the drainage issue must be determined and corrected. Surface or subsurface ponding longer than approximately

96 hours following a storm event poses a risk of vector (mosquito) breeding. Corrective maintenance, increased inspection and maintenance, BMP replacement, or a different BMP type will be required. If poor drainage persists after flushing of the paving, subsurface gravel, and/or underdrain(s) when applicable, or if it is determined that the underlying soils do not have the infiltration capacity expected, the Authority shall be contacted prior to any additional repairs or reconstruction.

Other Special Considerations. Site design BMPs, such as permeable pavement, installed within a new development or redevelopment project are components of an overall storm water management strategy for the project. The presence of site design BMPs within a project is usually a factor in the determination of the amount of runoff to be managed with structural BMPs (i.e., the amount of runoff expected to reach downstream retention or biofiltration basins that process storm water runoff from the project as a whole). When site design BMPs are not maintained or are removed, clogging or failure of downstream structural BMPs can result because of greater delivery of runoff and pollutants than intended for the structural BMP. Therefore, the Authority may require confirmation of maintenance

Appendix E: BMP Design Fact Sheets

of site design BMPs as part of their structural BMP maintenance documentation requirements. Site design BMPs that have been installed as part of the project should not be removed, nor should they be bypassed by re-routing roof drains or re-grading surfaces within the project. If changes are necessary, consult the Authority to determine requirements.

The runoff storage and infiltration surface area in this BMP are not readily accessible because they are subsurface. This means that clogging and poor drainage are not easily corrected. If the tributary area draining to the BMP includes unpaved areas, the sediment load from the tributary drainage area can be too high, reducing BMP function or clogging the BMP. All unpaved areas within the tributary drainage area should be stabilized with vegetation. Other pretreatment components to prevent transport of sediment to the paving surface, such as grass buffer strips, will extend the life of the subsurface components and infiltration surface. Along with proper stabilization measures and pretreatment within the tributary area, routine maintenance, including preventive vacuum/regenerative air street sweeping, is key to preventing clogging.

This page intentionally left blank

Summary of Standard Inspection and Maintenance

The property owner is responsible to ensure inspection, operation and maintenance of permanent BMPs on their property unless responsibility has been formally transferred to the Authority.

Maintenance frequencies listed in this table are average/typical frequencies. Actual maintenance needs are site-specific, and maintenance may be required more frequently. Maintenance must be performed whenever needed, based on maintenance indicators presented in this table. The BMP owner is responsible for conducting regular inspections to see when maintenance is needed based on the maintenance indicators. During the first year of operation of a structural BMP, inspection is recommended at least once prior to August 31 and then monthly from September through May. Inspection during a storm event is also recommended. After the initial period of frequent inspections, the minimum inspection and maintenance frequency can be determined based on the results of the first-year inspections.

Threshold/Indicator	Maintenance Action	Typical Maintenance Frequency
Preventive vacuum/regenerative air street sweeping	Pavement should be swept with a vacuum power or regenerative air street sweeper to maintain infiltration through paving surface	<ul style="list-style-type: none"> • Schedule/perform this preventive action at least twice per year.
Accumulation of sediment, litter, or debris on permeable pavement surface	Remove and properly dispose of accumulated materials. Inspect tributary area for exposed soil or other sources of sediment and apply stabilization measures to sediment source areas. Apply source control measures as applicable to sources of litter or debris.	<ul style="list-style-type: none"> • Inspect monthly and after every 0.5-inch or larger storm event. • Remove any accumulated materials found at each inspection.
Weeds growing on/through the permeable pavement surface	Remove weeds and add features as necessary to prevent weed intrusion. Use non-chemical methods (e.g., instead of pesticides, control weeds using mechanical removal, physical barriers, and/or physical changes in the surrounding area adjacent to pavement that will preclude weed intrusion into the pavement).	<ul style="list-style-type: none"> • Inspect monthly. • Remove any weeds found at each inspection.

Appendix E: BMP Design Fact Sheets

Threshold/Indicator	Maintenance Action	Typical Maintenance Frequency
<p>Standing water in permeable paving area following a storm event, or runoff is observed overflowing off the permeable paving surface during a storm event</p>	<p>This condition requires investigation of why infiltration is not occurring. If feasible, corrective action shall be taken to restore infiltration (e.g., pavement should be swept with a vacuum power or regenerative air street sweeper to restore infiltration rates, clear underdrains if underdrains are present). BMP may require retrofit if infiltration cannot be restored. The Authority shall be contacted prior to any repairs or reconstruction.</p>	<ul style="list-style-type: none"> • Inspect monthly and after every 0.5-inch or larger storm event. If standing water is observed, increase inspection frequency to after every 0.1-inch or larger storm event. • Maintain when needed.
<p>Presence of mosquitos/larvae</p> <p>For images of egg rafts, larva, pupa, and adult mosquitos, see http://www.mosquito.org/biology</p>	<p>If mosquitos/larvae are observed: first, immediately remove any standing water by dispersing to nearby landscaping; second, make corrective measures as applicable to restore BMP drainage to prevent standing water. If mosquitos persist following corrective measures to remove standing water, or if the BMP design does not meet the 96-hour drawdown criteria because the underlying soils do not have the infiltration capacity expected, the Authority shall be contacted to determine a solution. A different BMP type, or a Vector Management Plan prepared with concurrence from the County of San Diego Department of Environmental Health, may be required.</p>	<ul style="list-style-type: none"> • Inspect monthly and after every 0.5-inch or larger storm event. If mosquitos are observed, increase inspection frequency to after every 0.1-inch or larger storm event. • Maintain when needed.
<p>Damage to permeable paving surface (e.g., cracks, settlement, misaligned paver blocks, void spaces between paver blocks need fill materials replenished)</p>	<p>Repair or replace damaged surface as appropriate.</p>	<ul style="list-style-type: none"> • Inspect annually. • Maintain when needed.

Appendix E: BMP Design Fact Sheets

Threshold/Indicator	Maintenance Action	Typical Maintenance Frequency
Preventive vacuum/regenerative air street sweeping	Pavement should be swept with a vacuum power or regenerative air street sweeper to maintain infiltration through paving surface	<ul style="list-style-type: none"> • Schedule/perform this preventive action at least twice per year.
Accumulation of sediment, litter, or debris on permeable pavement surface	Remove and properly dispose of accumulated materials. Inspect tributary area for exposed soil or other sources of sediment and apply stabilization measures to sediment source areas. Apply source control measures as applicable to sources of litter or debris.	<ul style="list-style-type: none"> • Inspect monthly and after every 0.5-inch or larger storm event. • Remove any accumulated materials found at each inspection.
Weeds growing on/through the permeable pavement surface	Remove weeds and add features as necessary to prevent weed intrusion. Use non-chemical methods (e.g., instead of pesticides, control weeds using mechanical removal, physical barriers, and/or physical changes in the surrounding area adjacent to pavement that will preclude weed intrusion into the pavement).	<ul style="list-style-type: none"> • Inspect monthly. • Remove any weeds found at each inspection.
Standing water in permeable paving area following a storm event, or runoff is observed overflowing off the permeable paving surface during a storm event	This condition requires investigation of why infiltration is not occurring. If feasible, corrective action shall be taken to restore infiltration (e.g., pavement should be swept with a vacuum power or regenerative air street sweeper to restore infiltration rates, clear underdrains if underdrains are present). BMP may require retrofit if infiltration cannot be restored. The [City Engineer] shall be contacted prior to any repairs or reconstruction.	<ul style="list-style-type: none"> • Inspect monthly and after every 0.5-inch or larger storm event. If standing water is observed, increase inspection frequency to after every 0.1-inch or larger storm event. • Maintain when needed.

Threshold/Indicator	Maintenance Action	Typical Maintenance Frequency
<p>Presence of mosquitos/larvae</p> <p>For images of egg rafts, larva, pupa, and adult mosquitos, see http://www.mosquito.org/biology</p>	<p>If mosquitos/larvae are observed: first, immediately remove any standing water by dispersing to nearby landscaping; second, make corrective measures as applicable to restore BMP drainage to prevent standing water.</p> <p>If mosquitos persist following corrective measures to remove standing water, or if the BMP design does not meet the 96-hour drawdown criteria because the underlying soils do not have the infiltration capacity expected, the [City Engineer] shall be contacted to determine a solution. A different BMP type, or a Vector Management Plan prepared with concurrence from the County of San Diego Department of Environmental Health, may be required.</p>	<ul style="list-style-type: none"> • Inspect monthly and after every 0.5-inch or larger storm event. If mosquitos are observed, increase inspection frequency to after every 0.1-inch or larger storm event. • Maintain when needed.
<p>Damage to permeable paving surface (e.g., cracks, settlement, misaligned paver blocks, void spaces between paver blocks need fill materials replenished)</p>	<p>Repair or replace damaged surface as appropriate.</p>	<ul style="list-style-type: none"> • Inspect annually. • Maintain when needed.

E.8 SD-E Rain Barrels



Photo Credit: San Diego Low Impact Development Design Manual

Description

Rain barrels are containers that can capture rooftop runoff and store it for future use. With controlled timing and volume release, the captured rainwater can be used for irrigation or alternative grey water between storm events, thereby reducing runoff volumes and associated pollutants to downstream waterbodies. Rain barrels tend to be smaller systems, less than 100 gallons. Treatment can be achieved when rain barrels are used as part of a treatment train along with other BMPs that use captured flows in applications that do not result in discharges into the storm drain system. Rooftops are the ideal tributary areas for rain barrels. Because of San Diego's arid climate, some rain barrels may fill only a few times each year. Additionally, because of the implementation of harvest and use cisterns at the Airport, P&EAD should be consulted to determine the applicability of rain barrels for a project on a case-by-case basis.

Typical Rain Barrel Components
Storage container, barrel or tank for holding captured flows
Inlet and associated valves and piping
Outlet and associated valves and piping
Overflow outlet
Optional pump
Optional first flush diverters
Optional roof, supports, foundation, level indicator, and other accessories

Design Adaptations for Project Goals

Site design BMP to reduce effective impervious area and DCV. Barrels can be used as a site design feature to reduce the effective impervious area of the site by removing roof runoff from the site discharge. This can reduce the DCV and flow control requirements for the site.

Conceptual Design and Sizing Approach for Site Design

- 1) Determine the areas where rain barrels can be used in the site design to capture roof runoff to reduce the DCV. Rain barrels reduce the effective impervious area of the site by removing roof runoff from the site discharge.
- 2) Calculate the DCV per Appendix B.2, taking into account reduced runoff from permeable pavement areas.

MS4 Permit Category

Site Design

Manual Category

Site Design

Applicable Performance Criteria

Site Design

Primary Benefits

Conceptual Design and Sizing Approach for Site Design

Normal Expected Maintenance. Rain barrels can be expected to accumulate some debris that is small enough to pass through the inlet into the storage container. Leaves may accumulate at the inlet. Ancillary parts including valves, piping, screens, level indicators, and other accessories will wear and require occasional replacement. Maintenance of a rain barrel generally involves: removing accumulated debris from the inlet and storage container on a routine basis; and replacement of ancillary parts on an as-needed basis. A summary table of standard inspection and maintenance indicators is provided within this Fact Sheet. If the system includes a pump, maintenance of the pump should be based on the manufacturer's recommended maintenance plan.

Non-Standard Maintenance or BMP Failure. If any of the following scenarios are observed, the BMP is not performing as intended to protect downstream waterways from pollution and/or erosion. Corrective maintenance, increased inspection and maintenance, BMP replacement, or a different BMP type will be required.

- The inlet is found to be obstructed at every inspection such that storm water bypasses the rain barrel. The rain barrel is not functioning properly if it is not capturing storm water. This would require addition of ancillary features to protect the inlet, such as screens on roof gutters.
- The rain barrel is not drained between storm events. If the rain barrel is not drained between storm events, the storage volume will be diminished, and the rain barrel will not capture the required volume of storm water from subsequent storms. This would require implementation of practices onsite to drain and use the stored water, or a different BMP if onsite use cannot be reliably sustained.

Other Special Considerations. Site design BMPs, such as rain barrels, installed within a new development or redevelopment project are components of an overall storm water management strategy for the project. The presence of site design BMPs within a project is usually a factor in the determination of the amount of runoff to be managed with structural BMPs (i.e., the amount of runoff expected to reach downstream retention or biofiltration basins that process storm water runoff from the project as a whole). When site design BMPs are not maintained or are removed, clogging or failure of downstream structural BMPs can result because of greater delivery of runoff and pollutants than intended for the structural BMP. Therefore, the Authority may require confirmation of maintenance of site design BMPs as part of their structural BMP maintenance documentation requirements. Site design BMPs that have been installed as part of the project should not be removed, nor should they be bypassed by re-routing roof drains or re-grading surfaces within the project. If changes are necessary, consult the Authority to determine requirements.

Summary of Standard Inspection and Maintenance

The property owner is responsible to ensure inspection, operation and maintenance of permanent BMPs on their property unless responsibility has been formally transferred to the Authority.

Maintenance frequencies listed in this table are average/typical frequencies. Actual maintenance needs are site-specific, and maintenance may be required more frequently. Maintenance must be performed whenever needed, based on maintenance indicators presented in this table. The BMP owner is responsible for conducting regular inspections to see when maintenance is needed based on the maintenance indicators. During the first year of operation of a structural BMP, inspection is recommended at least once prior to August 31 and then monthly from September through May. Inspection during a storm event is also recommended. After the initial period of frequent inspections, the minimum inspection and maintenance frequency can be determined based on the results of the first-year inspections.

Threshold/Indicator	Maintenance Action	Typical Maintenance Frequency
Accumulation of debris at the inlet	Remove and properly dispose of accumulated materials.	<ul style="list-style-type: none"> Inspect monthly and after every 0.5-inch or larger storm event. Remove any accumulated materials found at each inspection.
Outlet blocked	Clear blockage.	<ul style="list-style-type: none"> Inspect monthly and after every 0.5-inch or larger storm event. Remove any accumulated materials found at each inspection.
Accumulation of debris in the storage container	Remove and properly dispose of accumulated materials.	<ul style="list-style-type: none"> Inspect twice per year. Maintain when needed.
Leaks or other damage to storage container	Repair or replace as applicable.	<ul style="list-style-type: none"> Inspect twice per year. Maintain when needed.
Standing water in storage container between storm events outside of normal use timeframe for the stored water. Normal use timeframe is 36 to 96 hours following a storm event.	Use the water as intended or disperse to landscaping.	<ul style="list-style-type: none"> Inspect monthly and after every 0.5-inch or larger storm event. If standing water is observed, increase inspection frequency to after every 0.1-inch or larger storm event. Maintain when needed.

Threshold/Indicator	Maintenance Action	Typical Maintenance Frequency
<p>Presence of mosquitos/larvae For images of egg rafts, larva, pupa, and adult mosquitos, see http://www.mosquito.org/biology</p>	<p>If mosquitos/larvae are observed: first, immediately remove any standing water by using the water as intended for irrigation or alternative grey water, or by dispersing to landscaping; second, check outlet for blockage and clear blockage if applicable to restore drainage; third, install barriers such as screens that prevent mosquito access to the storage container.</p>	<ul style="list-style-type: none"> • Inspect monthly and after every 0.5-inch or larger storm event. If mosquitos are observed, increase inspection frequency to after every 0.1-inch or larger storm event. • Maintain when needed.
<p>Leaks or other damage to ancillary parts including valves, piping, screens, level indicators, and other accessories</p>	<p>Repair or replace as applicable.</p>	<ul style="list-style-type: none"> • Inspect twice per year. • Maintain when needed.
<p>Rain barrel leaning or unstable, damage to roof, supports, anchors, or foundation</p>	<p>Make repairs as appropriate to correct the problem and stabilize the system.</p>	<ul style="list-style-type: none"> • Inspect twice per year. • Maintain when needed.

E.9 SD-F Amended Soils



Photo Credit: Orange County Technical Guidance Document

MS4 Permit Category

Site Design

Manual Category

Site Design

Applicable Performance Standard

Site Design

Primary Benefits

Volume Reduction
Peak Flow Attenuation

Description

Amended soils are soils whose physical, chemical, and biological characteristics have been altered from the natural condition to promote beneficial storm water characteristics. Amended soils shall be used as part of SD-B Impervious Area Dispersions, where applicable. Typical storm water management benefits associated with amended soils include:

- **Improved hydrological characteristics** – amended soils can promote infiltration, decrease runoff rates and volumes, and more effectively filter pollutants from storm water runoff
- **Improved vegetation health** – amended soils provide greater moisture retention, and altered chemical and biological characteristics that can result in healthier plant growth, reduced irrigation demands, and reduced need for fertilization and maintenance
- **Reduced erosion** – amended soils produce healthier plant growth and reduced runoff which results in reduced soil erosion

Not all amended soils have the same storm water benefits, the soil amendment used should be suited for the design purpose and design period of the amended area.

Design Adaptations for Project Goals

Varying categories of soil amendments have different benefits and applications. Mulch is a soil amendment that is added at grade, rather than mixed into the soil. Mulch reduces evaporation and improves retention. Shavings and compost are common soil amendments that improve biological and chemical properties of the soil. Native soil samples may need to be analyzed by a lab to determine the specific soil amendments needed to achieve the desired infiltration, retention, and/or filtration rates.

Design Criteria and Considerations

Soil amendments must meet the following design criteria and considerations. Deviations from the below criteria may be approved at the discretion of the Authority if appropriate:

<i>Siting and Design</i>	<i>Intent/Rationale</i>
<input type="checkbox"/> When mulch is used as an amendment it is applied at grade over all planting areas to a depth of 3".	Mulch should be applied on top and not mixed into underlying soils
<input type="checkbox"/> When shavings or compost is used as an amendment, it is rototilled into the native soil to a minimum depth of 6" (12 inches preferred).	If soil is not completely mixed the overall benefit will be reduced.
<input type="checkbox"/> Compost meets the criteria in Appendix F	If poor quality compost is used, it will have negative impact to water quality.
<input type="checkbox"/> Soil amendments are free of stones, stumps, roots, glass, plastic, metal, and other deleterious materials.	Large debris in amended soils can cause localized erosion. Trash/harmful materials can result in personal injury or contamination.
<input type="checkbox"/> Mixing of soils are done prior to planting	Soil mixing before planting results in a more homogeneous mixing and will reduce the stress on plants.
<input type="checkbox"/> Care is taken around existing trees and shrubs to prevent root damage during construction and soil amendment application.	Preservation of existing established vegetation is an important part of site design and erosion control.
<input type="checkbox"/> Soil amendments are applied at the end of construction	Soil amendments applied too soon in the construction process may become over compacted reducing effectiveness.
<input type="checkbox"/> Soil amendments are compatible with planned vegetation	The soil amendments impact the pH and salinity of the soil. Some plants have sensitive pH and/or salinity tolerance ranges.

Conceptual Design and Sizing Approach for Site Design

- When soil amendments are used, a runoff factor of 0.1 can be used for DCV calculation for the amended area.
- Amended soils should be used as part of SD-B Impervious Area Dispersion, and to increase the retention volume in other BMPs.

Maintenance

Annual maintenance may be required to determine reapplication requirements of amended soils. Amended soils should be regularly inspected for signs of compaction, waterlogging, and unhealthy vegetation.

E.10 HU-1 Cistern



Photo Credit: Water Environment Research Foundation: WERF.org

MS4 Permit Category

Retention

Manual Category

Harvest and Use

Applicable Performance Standards

Pollutant Control

Flow Control

Primary Benefits

Volume Reduction

Peak Flow Attenuation

Description

Cisterns are containers that can capture rooftop runoff and store it for future use. With controlled timing and volume release, the captured rainwater can be used for irrigation or alternative grey water between storm events, thereby reducing runoff volumes and associated pollutants to downstream water bodies. Cisterns are larger systems (generally >100 gallons) that can be self-contained aboveground or below ground systems. Treatment can be achieved when cisterns are used as part of a treatment train along with other BMPs that use captured flows in applications that do not result in discharges into the storm drain system. Rooftops are the ideal tributary areas for cisterns.

Typical cistern components include:

- Storage container, barrel or tank for holding captured flows
- Inlet and associated valves and piping
- Outlet and associated valves and piping
- Overflow outlet
- Optional pump
- Optional first flush diverters
- Optional roof, supports, foundation, level indicator, and other accessories

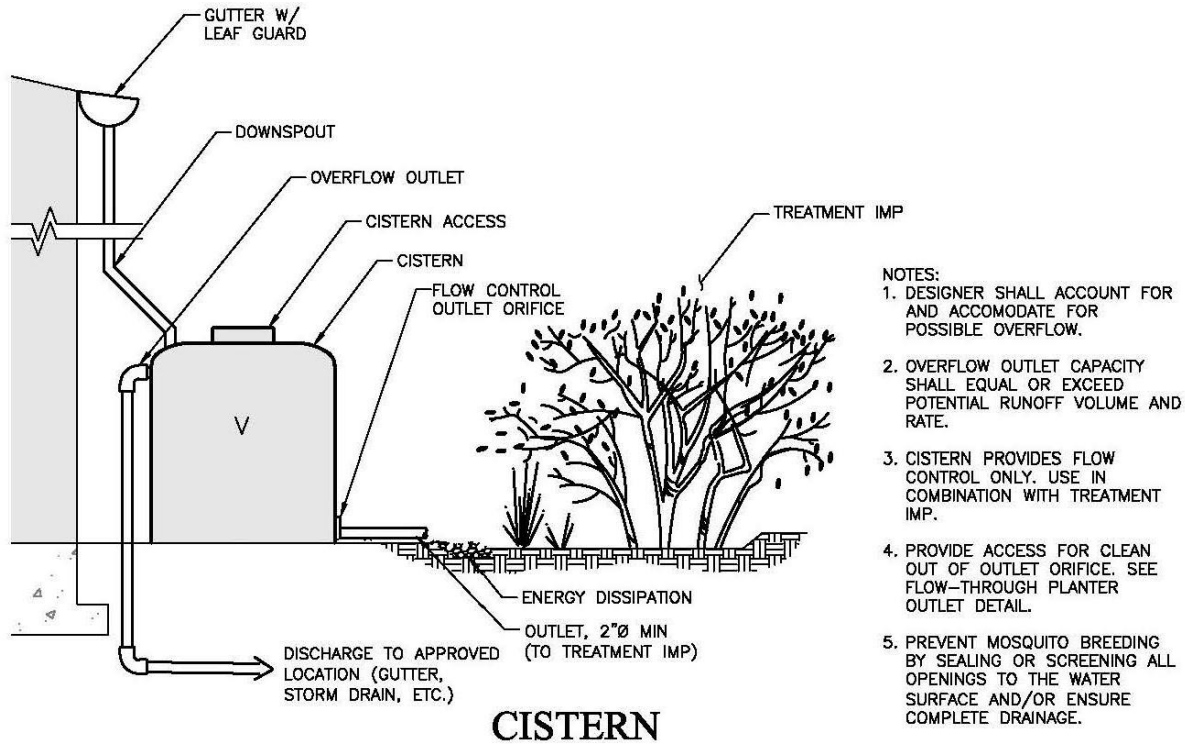

Source: City of San Diego Storm Water Standards

Design Adaptations for Project Goals

Site design BMP to reduce effective impervious area and DCV. Cisterns can be used as a site design feature to reduce the effective impervious area of the site by removing roof runoff from the site discharge. This can reduce the DCV and flow control requirements for the site.

Harvest and use for storm water pollutant control. Typical uses for captured flows include irrigation, toilet flushing, cooling system makeup, and vehicle and equipment washing.

Integrated storm water flow control and pollutant control configuration. Cisterns provide flow control in the form of volume reduction and/or peak flow attenuation and storm water treatment through elimination of discharges of pollutants. Additional flow control can be achieved by sizing the cistern to include additional detention storage and/or real-time automated flow release controls.

Design Criteria and Considerations

Cisterns must meet the following design criteria. Deviations from the below criteria may be approved at the discretion of the Authority if it is determined to be appropriate:

<i>Siting and Design</i>	<i>Intent/Rationale</i>
<input type="checkbox"/> Cisterns are sized to detain the full DCV of contributing area and empty within 36 hours.	Draining the cistern makes the storage volume available to capture the next storm. The applicant has an option to use a different drawdown time up to 96 hours if the volume of the facility is adjusted using the percent capture method in Appendix B.4.2. If drawdown time is greater than 96 hours, a vector control plan must be submitted to Authority.
<input type="checkbox"/> Cisterns are fitted with a flow control device such as an orifice or a valve to limit outflow in accordance with drawdown time requirements.	Flow control provides flow attenuation benefits and limits cistern discharge to downstream facilities during storm events.
<input type="checkbox"/> Cisterns are designed to drain completely, leaving no standing water, and all entry points are fitted with traps or screens, or sealed.	Complete drainage and restricted entry prevent mosquito habitat.
<input type="checkbox"/> Leaf guards and/or screens are provided to prevent debris from accumulating in the cistern.	Leaves and organic debris can clog the outlet of the cistern.
<input type="checkbox"/> Access is provided for maintenance and the cistern outlets are accessible and designed to allow easy cleaning.	Properly functioning outlets are needed to maintain proper flow control in accordance with drawdown time requirements.
<input type="checkbox"/> Cisterns must be designed and sited such that overflow will be conveyed safely overland to the storm drain system or discharge point.	Safe overflow conveyance prevents flooding and damage of property.

Conceptual Design and Sizing Approach for Site Design and Storm Water Pollutant Control

- 1) Calculate the DCV for site design per Appendix B.
- 2) Determine the locations on the site where cisterns can be located to capture and detain the DCV from roof areas without subsequent discharge to the storm drain system. Cisterns are best located in close proximity to building and other roofed structures to minimize piping. Cisterns can also be used as part of a treatment train upstream by increasing pollutant control through delayed runoff to infiltration BMPs such as bioretention without underdrain facilities.
- 3) Use the sizing worksheet in Appendix B.3 to determine if full or partial capture of the DCV is achievable.
- 4) The remaining DCV to be treated should be calculated for use in sizing downstream BMP(s).

Conceptual Design and Sizing Approach when Storm Water Flow Control is Applicable

If control of flow rates and/or duration is desired on an Authority project, significant cistern volumes will typically be required, and therefore the following steps should be taken prior to determination of

site design and storm water pollutant control. Pre-development and post-project flow rates and durations should be determined as discussed in Chapter 6 of the Copermittees' original Model BMP Design Manual. (As previously indicated in this Manual, development within Authority jurisdiction is not subject to hydromodification management requirements, however this sub-section remains as a reference).

- 1) Verify that cistern siting and design criteria have been met. Design for flow control can be achieved using various design configurations, shapes, and quantities of cisterns.
- 2) Iteratively determine the cistern storage volume required to provide detention storage to reduce flow rates and durations to allowable limits. Flow rates and durations can be controlled from detention storage by altering outlet structure orifice size(s) and/or water control valve operation.
- 3) Verify that the cistern is drawdown within 36 hours. The drawdown time can be estimated by dividing the storage volume by the rate of use of harvested water.
- 4) If the cistern cannot fully provide the flow rate and duration control required by this Manual, a downstream structure with additional storage volume or infiltration capacity such as a biofiltration can be used to provide remaining flow control.

Maintenance Overview

Normal Expected Maintenance. Cisterns can be expected to accumulate sediment and debris that is small enough to pass through the inlet into the storage container. Larger debris such as leaves, or trash may accumulate at the inlet. Although the storage container is generally a permanent structure, ancillary parts including valves, piping, screens, level indicators, and other accessories will wear and require occasional replacement. Maintenance of a cistern generally involves: removing accumulated sediment and debris from the inlet and storage container on a routine basis; and replacement of ancillary parts on an as-needed basis. A summary table of standard inspection and maintenance indicators is provided within this Fact Sheet. If the system as a whole includes a pump or other electrical equipment, maintenance of the equipment shall be based on the manufacturer's recommended maintenance plan.

Non-Standard Maintenance or BMP Failure. If any of the following scenarios are observed, the BMP is not performing as intended to protect downstream waterways from pollution and/or erosion. Corrective maintenance, increased inspection and maintenance, BMP replacement, or a different BMP type will be required.

- The inlet is found to be obstructed at every inspection such that storm water bypasses the cistern. The cistern is not functioning properly if it is not capturing storm water. This would require addition of ancillary features to protect the inlet, or pretreatment measures within the watershed draining to the cistern to intercept larger debris, such as screens on roof gutters, or drainage inserts within catch basins. Increase the frequency of inspection until the issue is resolved.
- Accumulation of sediment within one year is greater than 25 percent of the volume of the cistern. This means the sediment load from the tributary drainage area has diminished the storage volume of the cistern and the cistern will not capture the required volume of storm

Appendix E: BMP Design Fact Sheets

water. This would require pretreatment measures within the tributary area draining to the cistern to intercept sediment.

- The cistern is not drained between storm events. If the cistern is not drained between storm events, the storage volume will be diminished, and the cistern will not capture the required volume of storm water from subsequent storms. This would require implementation of practices onsite to drain and use the stored water, or a different BMP if onsite use cannot be reliably sustained.

This page intentionally left blank

Summary of Standard Inspection and Maintenance

The property owner is responsible to ensure inspection, operation and maintenance of permanent BMPs on their property unless responsibility has been formally transferred to the Authority.

Maintenance frequencies listed in this table are average/typical frequencies. Actual maintenance needs are site-specific, and maintenance may be required more frequently. Maintenance must be performed whenever needed, based on maintenance indicators presented in this table. The BMP owner is responsible for conducting regular inspections to see when maintenance is needed based on the maintenance indicators. During the first year of operation of a structural BMP, inspection is recommended at least once prior to August 31 and then monthly from September through May. Inspection during a storm event is also recommended. After the initial period of frequent inspections, the minimum inspection and maintenance frequency can be determined based on the results of the first-year inspections.

Threshold/Indicator	Maintenance Action	Typical Maintenance Frequency
Accumulation of sediment, litter, or debris at the inlet	Remove and properly dispose of accumulated materials.	<ul style="list-style-type: none"> • Inspect monthly and after every 0.5-inch or larger storm event. • Remove any accumulated materials found at each inspection.
Outlet blocked	Clear blockage.	<ul style="list-style-type: none"> • Inspect monthly and after every 0.5-inch or larger storm event. • Remove any accumulated materials found at each inspection.

Appendix E: BMP Design Fact Sheets

Threshold/Indicator	Maintenance Action	Typical Maintenance Frequency
Accumulation of sediment, litter, or debris in the storage container	Remove and properly dispose of accumulated materials.	<ul style="list-style-type: none"> ● Inspect monthly. If the BMP is 25% full* or more in one month, increase inspection frequency to monthly plus after every 0.1-inch or larger storm event. ● Remove materials annually (minimum), or more frequently when BMP is 25% full* (or at manufacturer threshold if manufacturer threshold is less than 25% full*) in less than one year, or if ● accumulation blocks outlet
Standing water in storage container between storm events outside of normal use timeframe for the stored water. Normal use timeframe is 36 to 96 hours following a storm event depending on the purpose and design of the cistern.	Use the water as intended or disperse to landscaping. Implement practices onsite to drain and use the stored water. Contact the Authority to determine a solution if onsite use cannot be reliably sustained.	<ul style="list-style-type: none"> ● Inspect monthly and after every 0.5-inch or larger storm event. If standing water is observed, increase inspection frequency to after every 0.1- inch or larger storm event. ● Maintain when needed.
Presence of mosquitos/larvae For images of egg rafts, larva, pupa, and adult mosquitos, see http://www.mosquito.org/biology	If mosquitos/larvae are observed: first, immediately remove any standing water by using the water as intended for irrigation or alternative grey water, or by dispersing to landscaping; second, check cistern outlet for blockage and clear blockage if applicable to restore drainage; third, install barriers such as screens that prevent mosquito access to the storage container.	<ul style="list-style-type: none"> ● Inspect monthly and after every 0.5-inch or larger storm event. If mosquitos are observed, increase inspection frequency to after every 0.1-inch or larger storm event. ● Maintain when needed.
Leaks or other damage to ancillary parts including valves, piping, screens, level indicators, and other accessories	Repair or replace as applicable.	<ul style="list-style-type: none"> ● Inspect twice per year. ● Maintain when needed.

Appendix E: BMP Design Fact Sheets

Threshold/Indicator	Maintenance Action	Typical Maintenance Frequency
Leaks or other damage to storage container	Repair or replace as applicable.	<ul style="list-style-type: none"> • Inspect twice per year. • Maintain when needed.
Cistern leaning or unstable, damage to roof, supports, anchors, or foundation	Make repairs as appropriate to correct the problem and stabilize the system.	<ul style="list-style-type: none"> • Inspect twice per year. • Maintain when needed.

This page intentionally left blank

E.11 INF-1 Infiltration Basin



MS4 Permit Category

Retention

Manual Category

Infiltration

Applicable Performance Standard

Pollutant Control

Flow Control

Primary Benefits

Volume Reduction

Peak Flow Attenuation

Photo Credit: <http://www.stormwaterpartners.com/facilities/basin.html>

Description

An infiltration basin typically consists of an earthen basin with a flat bottom constructed in naturally pervious soils. An infiltration basin retains storm water and allows it to evaporate and/or percolate into the underlying soils. The bottom of an infiltration basin is typically vegetated with native grasses or turf grass; however other types of vegetation can be used if they can survive periodic inundation and long inter-event dry periods. Treatment is achieved primarily through infiltration, filtration, sedimentation, biochemical processes and plant uptake. Infiltration basins can be constructed as linear **trenches** or as **underground infiltration galleries**.

Typical infiltration basin components include:

- Inflow distribution mechanisms (e.g., perimeter flow spreader or filter strips)
- Energy dissipation mechanism for concentrated inflows (e.g., splash blocks or riprap)
- Forebay to provide pretreatment surface ponding for captured flows
- Vegetation selected based on basin use, climate, and ponding depth
- Uncompacted native soils at the bottom of the facility
- Overflow structure

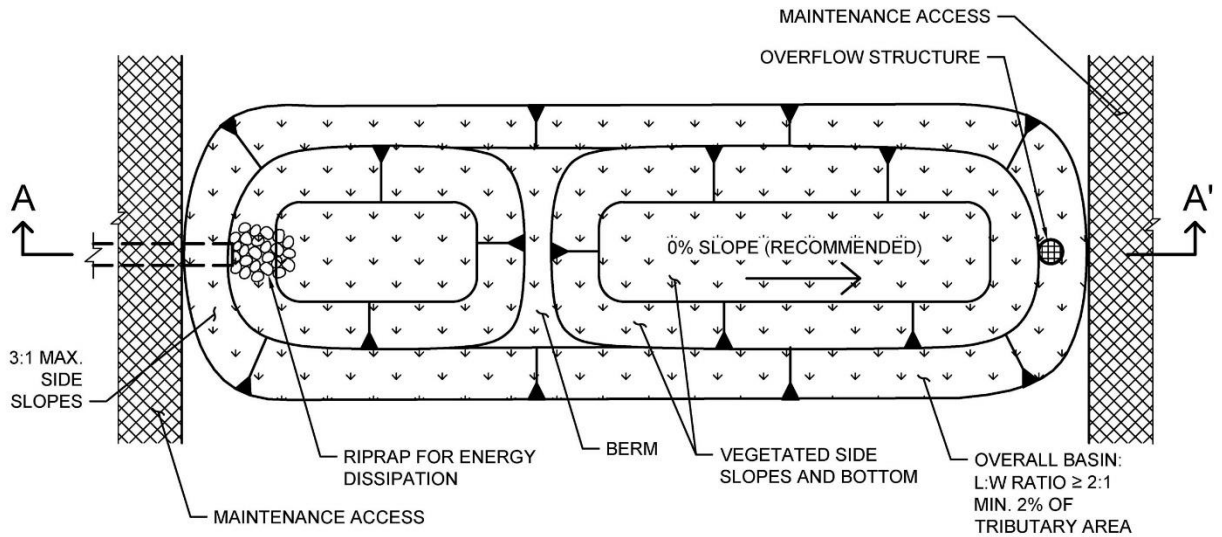

PLAN
NOT TO SCALE

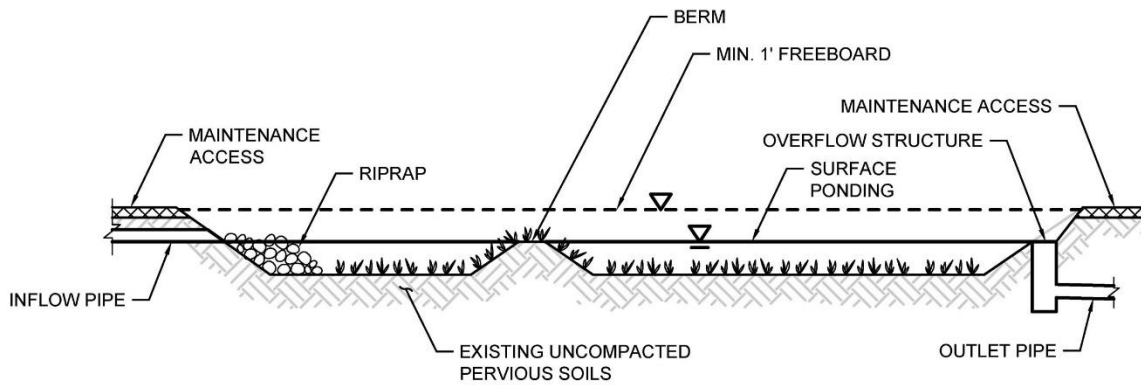

SECTION A-A'
NOT TO SCALE

Typical Plan and Section View of an Infiltration BMP

Design Adaptations for Project Goals

Full infiltration BMP for storm water pollutant control. Infiltration basins can be used as a pollutant control BMP, designed to infiltrate runoff from direct rainfall as well as runoff from adjacent areas that are tributary to the BMP. Infiltration basins must be designed with an infiltration storage volume (a function of the surface ponding volume) equal to the full DCV and able to meet drawdown time limitations.

Integrated storm water flow control and pollutant control configuration. Infiltration basins can also be designed for flow rate and duration control by providing additional infiltration storage through increasing the surface ponding volume.

Recommended Siting Criteria

<i>Siting Criteria</i>	<i>Intent/Rationale</i>
<input type="checkbox"/> Placement observes geotechnical recommendations regarding potential hazards (e.g., slope stability, landslides, liquefaction zones) and setbacks (e.g., slopes, foundations, utilities).	Must not negatively impact existing site geotechnical concerns.
<input type="checkbox"/> Selection and design of basin is based on infiltration feasibility criteria and appropriate design infiltration rate (See Appendix C and D).	Must operate as a full infiltration design and must be supported by drainage area and in-situ infiltration rate feasibility findings.

Recommended BMP Component Divisions

<i>BMP Component</i>	<i>Dimension</i>	<i>Intent/Rationale</i>
Freeboard	≥ 12 inches	Freeboard minimizes risk of uncontrolled surface discharge.
Ponding Area Side Slopes	3H:1V or shallower	Gentler side slopes are safer, less prone to erosion, able to establish vegetation more quickly and easier to maintain.
Settling Forebay Volume	≥ 25% of facility volume	A forebay to trap sediment can decrease frequency of required maintenance. Other pretreatment devices may be used in accordance with Appendix B.6.

Design Criteria and Considerations

Infiltration basins must meet the following design criteria. Deviations from the below criteria may be approved at the discretion of the Authority if it is determined to be appropriate:

<i>Design Criteria</i>	<i>Intent/Rationale</i>
<input type="checkbox"/> Finish grade of the facility is ≤ 2% (0% recommended)	Flatter surfaces reduce erosion and channelization with the facility.
<input type="checkbox"/> Infiltration of surface ponding is limited to a 36-hour drawdown time.	Prolonged surface ponding reduce volume available to capture subsequent storms. The applicant has an option to use a different drawdown time up to 96 hours if the volume of the facility is adjusted using the percent capture method in Appendix B.4.2.

<i>Design Criteria</i>	<i>Intent/Rationale</i>
<i>Inflow and Overflow Structures</i>	
<input type="checkbox"/> Inflow and outflow structures are accessible by required equipment (e.g., vactor truck) for inspection and maintenance.	Maintenance will prevent clogging and ensure proper operation of the flow control structures.
<input type="checkbox"/> Inflow velocities are limited to 3 ft/s or less or use energy dissipation methods (e.g., riprap, level spreader) for concentrated inflows.	High inflow velocities can cause erosion, scour and/or channeling.
<input type="checkbox"/> Overflow is safely conveyed to a downstream storm drain system or discharge point. Size overflow structure to pass 100-year peak flow for on-line basins and water quality peak flow for off-line basins.	Planning for overflow lessens the risk of property damage due to flooding.

Conceptual Design and Sizing Approach for Storm Water Pollutant Control

To design infiltration basins for storm water pollutant control only (no flow control required), the following steps should be taken:

- 1) Verify that siting and design criteria have been met, including placement and basin area requirements, forebay volume, and maximum slopes for basin sides and bottom.
- 2) Calculate the DCV per Appendix B based on expected site design runoff for tributary areas.
- 3) Use the sizing worksheet (Appendix B.4) to determine if full infiltration of the DCV is achievable based on the infiltration storage volume calculated from the surface ponding area and depth for a maximum 36-hour drawdown time. The drawdown time can be estimated by dividing the average depth of the basin by the design infiltration rate. Appendix D provides guidance on evaluating a site’s infiltration rate.

Conceptual Design and Sizing Approach for Storm Water Pollutant Treatment and Flow Control

If control of flow rates and/or durations is desired on an Authority project, significant surface ponding volume will typically be required, and therefore the following steps should be taken prior to determination of storm water pollutant control design. Pre-development and post-project flow rates and durations should be determined as discussed in Chapter 6 of the Copermittees’ original Model BMP Design Manual. (As previously indicated in this Manual, development within Authority jurisdiction is not subject to hydromodification management requirements, however this sub-section remains as a reference).

- 1) Verify that siting and design criteria have been met, including placement and basin area requirements, forebay volume, and maximum slopes for basin sides and bottom.

- 2) Iteratively determine the surface ponding required to provide infiltration storage to reduce flow rates and durations to allowable limits while adhering to the maximum 36-hour drawdown time. Flow rates and durations can be controlled using flow splitters that route the appropriate inflow amounts to the infiltration basin and bypass excess flows to the downstream storm drain system or discharge point.
- 3) If an infiltration basin cannot fully provide the flow rate and duration control required by this Manual, an upstream or downstream structure with appropriate storage volume such as an underground vault can be used to provide additional control.
- 4) After the infiltration basin has been designed to meet flow control requirements, calculations must be completed to verify if storm water pollutant control requirements to treat the DCV have been met.

Maintenance Overview

Normal Expected Maintenance. Infiltration basins require routine maintenance to: remove accumulated materials such as sediment, trash or debris from the forebay and the basin; maintain vegetation health if the BMP includes vegetation; and maintain integrity of side slopes, inlets, energy dissipators, and outlets. A summary table of standard inspection and maintenance indicators is provided within this Fact Sheet.

Non-Standard Maintenance or BMP Failure. If any of the following scenarios are observed, the BMP is not performing as intended to protect downstream waterways from pollution and/or erosion. Corrective maintenance, increased inspection and maintenance, BMP replacement, or a different BMP type will be required.

- The BMP is not drained between storm events. Surface ponding longer than approximately 24 hours following a storm event may be detrimental to vegetation health, and surface or subsurface ponding longer than approximately 96 hours following a storm event poses a risk of vector (mosquito) breeding. Poor drainage can result from clogging of the underlying native soils or clogging of covers applied at the basin surface such as topsoil, mulch, or rock layer. The specific cause of the drainage issue must be determined and corrected. For surface-level basins (i.e., not underground infiltration galleries), surface cover materials can be removed and replaced, and/or native soils can be scarified or tilled to help reestablish infiltration. If it is determined that the underlying native soils have been compacted or do not have the infiltration capacity expected, or if the infiltration surface area is not accessible (e.g., an underground infiltration gallery) the Authority shall be contacted prior to any additional repairs or reconstruction.
- Sediment, trash, or debris accumulation has filled the forebay or other pretreatment device within one month, or if no forebay or other pretreatment device is present, has filled greater than 25 percent of the surface ponding volume within one maintenance cycle. This means the load from the tributary drainage area is too high, reducing BMP function or clogging the BMP. This would require adding a forebay or other pretreatment measures within the tributary area draining to the BMP to intercept the materials if no pretreatment component is present, or increased maintenance frequency for an existing forebay or other pretreatment device. Pretreatment components, especially for sediment, will extend the life of the infiltration basin.

Appendix E: BMP Design Fact Sheets

- Erosion due to concentrated storm water runoff flow that is not readily corrected by adding erosion control blankets, adding stone at flow entry points, or minor re-grading to restore proper drainage according to the original plan. If the issue is not corrected by restoring the BMP to the original plan and grade, the Authority shall be contacted prior to any additional repairs or reconstruction.

Other Special Considerations. If the infiltration basin is vegetated: Vegetated structural BMPs that are constructed in the vicinity of, or connected to, an existing jurisdictional water or wetland could inadvertently result in creation of expanded waters or wetlands. As such, vegetated structural BMPs have the potential to come under the jurisdiction of the United States Army Corps of Engineers, SDRWQCB, California Department of Fish and Wildlife, or the United States Fish and Wildlife Service. This could result in the need for specific resource agency permits and costly mitigation to perform maintenance of the structural BMP. Along with proper placement of a structural BMP, routine maintenance is key to preventing this scenario.

Summary of Standard Inspection and Maintenance

The property owner is responsible to ensure inspection, operation, and maintenance of permanent BMPs on their property unless responsibility has been formally transferred to the Authority.

Maintenance frequencies listed in this table are average/typical frequencies. Actual maintenance needs are site-specific, and maintenance may be required more frequently. Maintenance must be performed whenever needed, based on maintenance indicators presented in this table. The BMP owner is responsible for conducting regular inspections to see when maintenance is needed based on the maintenance indicators. During the first year of operation of a structural BMP, inspection is recommended at least once prior to August 31 and then monthly from September through May. Inspection during a storm event is also recommended. After the initial period of frequent inspections, the minimum inspection and maintenance frequency can be determined based on the results of the first-year inspections.

Threshold/Indicator	Maintenance Action	Typical Maintenance Frequency
Accumulation of sediment, litter, or debris in forebay and/or basin	Remove and properly dispose of accumulated materials, (without damage to vegetation when applicable).	<ul style="list-style-type: none"> • Inspect monthly. If the forebay is 25% full* or more in one month, increase inspection frequency to monthly plus after every 0.1-inch or larger storm event. • Remove any accumulated materials found within the infiltration area at each inspection. • When the BMP includes a forebay, materials must be removed from the forebay when the forebay is 25% full*, or if accumulation within the forebay blocks flow to the infiltration area.
Obstructed inlet or outlet structure	Clear blockage.	<ul style="list-style-type: none"> • Inspect monthly and after every 0.5-inch or larger storm event. • Remove any accumulated materials found at each inspection.

Appendix E: BMP Design Fact Sheets

Threshold/Indicator	Maintenance Action	Typical Maintenance Frequency
Poor vegetation establishment (when the BMP includes vegetated surface by design)	Re-seed, re-plant, or re-establish vegetation per original plans.	<ul style="list-style-type: none"> • Inspect monthly. • Maintain when needed.
Dead or diseased vegetation (when the BMP includes vegetated surface by design)	Remove dead or diseased vegetation, re-seed, re-plant, or re-establish vegetation per original plans.	<ul style="list-style-type: none"> • Inspect monthly. • Maintain when needed.
Overgrown vegetation (when the BMP includes vegetated surface by design)	Mow or trim as appropriate.	<ul style="list-style-type: none"> • Inspect monthly. • Maintain when needed.
Erosion due to concentrated irrigation flow	Repair/re-seed/re-plant eroded areas and adjust the irrigation system.	<ul style="list-style-type: none"> • Inspect monthly. • Maintain when needed.
Erosion due to concentrated storm water runoff flow	Repair/re-seed/re-plant eroded areas and make appropriate corrective measures such as adding erosion control blankets, adding stone at flow entry points, or minor re-grading to restore proper drainage according to the original plan. If the issue is not corrected by restoring the BMP to the original plan and grade, the Authority shall be contacted prior to any additional repairs or reconstruction.	<ul style="list-style-type: none"> • Inspect after every 0.5-inch or larger storm event. If erosion due to storm water flow has been observed, increase inspection frequency to after every 0.1-inch or larger storm event. • Maintain when needed. If the issue is not corrected by restoring the BMP to the original plan and grade, the Authority shall be contacted prior to any additional repairs or reconstruction.

Threshold/Indicator	Maintenance Action	Typical Maintenance Frequency
<p>Standing water in infiltration basin without subsurface infiltration gallery for longer than 24-96 hours following a storm event</p>	<p>Make appropriate corrective measures such as adjusting irrigation system, removing obstructions of debris or invasive vegetation, or removing/replacing clogged or compacted surface treatments and/or scarifying or tilling native soils. Always remove deposited sediments before scarification and use a hand-guided rotary tiller. If it is determined that the underlying native soils have been compacted or do not have the infiltration capacity expected, the Authority shall be contacted prior to any additional repairs or reconstruction.</p>	<ul style="list-style-type: none"> • Inspect monthly and after every 0.5-inch or larger storm event. If standing water is observed, increase inspection frequency to after every 0.1-inch or larger storm event. • Maintain when needed.
<p>Standing water in subsurface infiltration gallery for longer than 24-96 hours following a storm event</p>	<p>This condition requires investigation of why infiltration is not occurring. If feasible, corrective action shall be taken to restore infiltration (e.g., flush fine sediment or remove and replace clogged soils). BMP may require retrofit if infiltration cannot be restored. The Authority shall be contacted prior to any repairs or reconstruction.</p>	<ul style="list-style-type: none"> • Inspect monthly and after every 0.5-inch or larger storm event. If standing water is observed, increase inspection frequency to after every 0.1-inch or larger storm event. • Maintain when needed.

Threshold/Indicator	Maintenance Action	Typical Maintenance Frequency
<p>Presence of mosquitos/larvae</p> <p>For images of egg rafts, larva, pupa, and adult mosquitos, see http://www.mosquito.org/biology</p>	<p>If mosquitos/larvae are observed: first, immediately remove any standing water by dispersing to nearby landscaping; second, make corrective measures as applicable to restore BMP drainage to prevent standing water. For subsurface infiltration galleries, ensure access covers are tight fitting, with gaps or holes no greater than 1/16 inch, and/or install barriers such as inserts or screens that prevent mosquito access to the subsurface storage.</p> <p>If mosquitos persist following corrective measures to remove standing water, or if the BMP design does not meet the 96-hour drawdown criteria because the underlying native soils have been compacted or do not have the infiltration capacity expected, the Authority shall be contacted to determine a solution. A different BMP type, or a Vector Management Plan prepared with concurrence from the County of San Diego Department of Environmental Health, may be required.</p>	<ul style="list-style-type: none"> • Inspect monthly and after every 0.5-inch or larger storm event. If mosquitos are observed, increase inspection frequency to after every 0.1-inch or larger storm event. • Maintain when needed.
<p>Damage to structural components such as weirs, inlet or outlet structures</p>	<p>Repair or replace as applicable.</p>	<ul style="list-style-type: none"> • Inspect annually. • Maintain when needed.

“25% full” is defined as ¼ of the depth from the design bottom elevation to the crest of the outflow structure (e.g., if the height to the outflow opening is 12 inches from the bottom elevation, then the materials must be removed when there is 3 inches of accumulation – this should be marked on the outflow structure).

E.12 INF-2 Bioretention



MS4 Permit Category

Retention

Manual Category

Infiltration

Applicable Performance Standard

Pollutant Control

Flow Control

Primary Benefits

Volume Reduction

Treatment

Peak Flow Attenuation

Photo Credit: Ventura County Technical Guidance Document

Description

Bioretention (bioretention without underdrain) facilities are vegetated surface water systems that filter water through vegetation and soil or engineered media prior to infiltrating into native soils. These facilities are designed to infiltrate the full DCV. Bioretention facilities are commonly incorporated into the site within parking lot landscaping, along roadsides, and in open spaces. They can be constructed inground or partially aboveground, such as planter boxes with open bottoms (no impermeable liner at the bottom) to allow infiltration. Treatment is achieved through filtration, sedimentation, sorption, infiltration, biochemical processes and plant uptake.

Typical bioretention without underdrain components include:

- Inflow distribution mechanisms (e.g., perimeter flow spreader or filter strips)
- Energy dissipation mechanism for concentrated inflows (e.g., splash blocks or riprap)
- Shallow surface ponding for captured flows
- Side slope and basin bottom vegetation selected based on expected climate and ponding depth
- Non-floating mulch layer (optional)
- Media layer (planting mix or engineered media) capable of supporting vegetation growth
- Filter course layer consisting of aggregate to prevent the migration of fines into uncompacted native soils or the optional aggregate storage layer
- Optional aggregate storage layer for additional infiltration storage

- Uncompacted native soils at the bottom of the facility
- Overflow structure

Design Adaptations for Project Goals

- **Full infiltration BMP for storm water pollutant control.** Bioretention can be used as a pollutant control BMP designed to infiltrate runoff from direct rainfall as well as runoff from adjacent tributary areas. Bioretention facilities must be designed with an infiltration storage volume (a function of the ponding, media and aggregate storage volumes) equal to the full DCV and able to meet drawdown time limitations.
- **Integrated storm water flow control and pollutant control configuration.** Bioretention facilities can be designed to provide flow rate and duration control. This may be accomplished by providing greater infiltration storage with increased surface ponding and/or aggregate storage volume for storm water flow control.

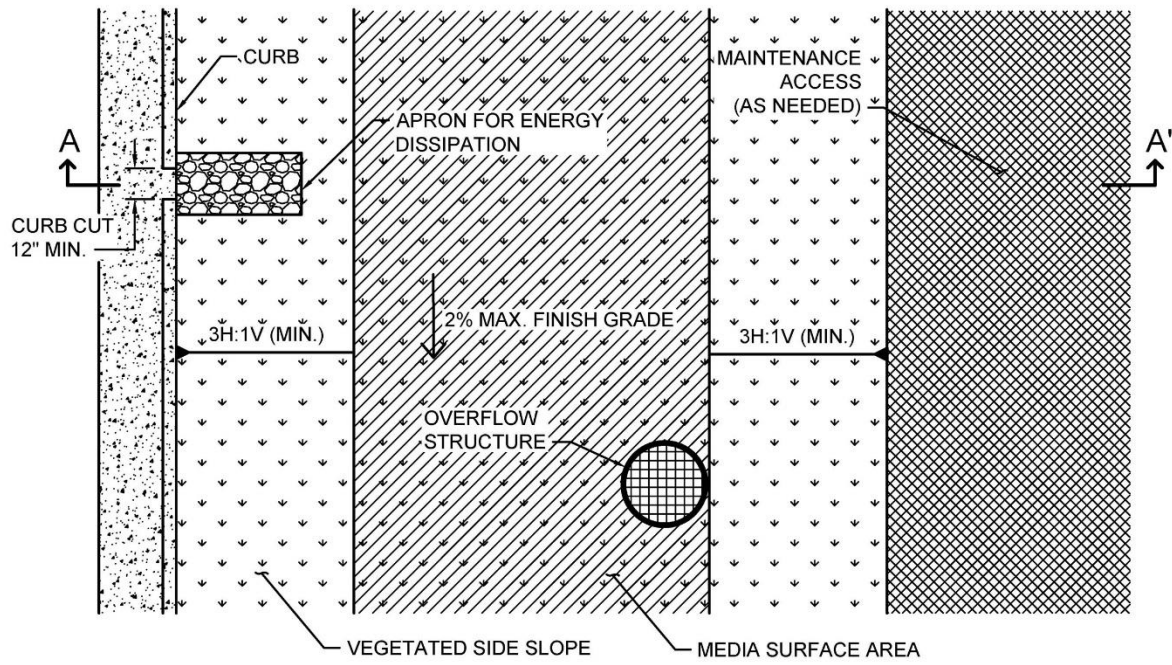

PLAN
NOT TO SCALE

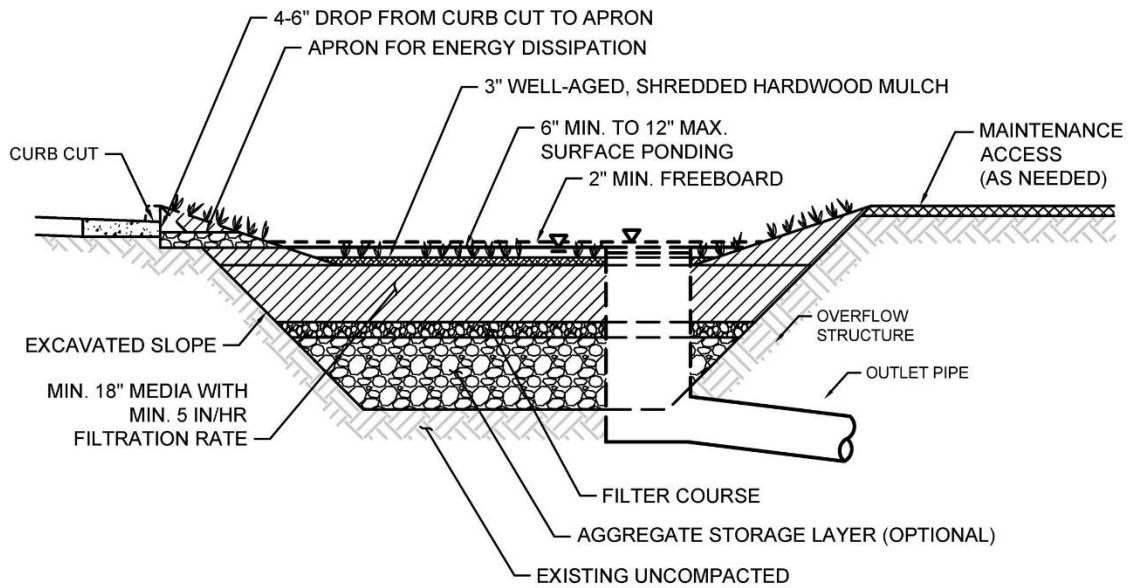

SECTION A-A'
NOT TO SCALE

Typical Plan and Section View of a Bioretention BMP

Design Adaptations for Project Goals

- **Full infiltration BMP for storm water pollutant control.** Bioretention can be used as a pollutant control BMP designed to infiltrate runoff from direct rainfall as well as runoff from adjacent tributary areas. Bioretention facilities must be designed with an infiltration storage volume (a function of the ponding, media and aggregate storage volumes) equal to the full DCV and able to meet drawdown time limitations.
- **Integrated storm water flow control and pollutant control configuration.** Bioretention facilities can be designed to provide flow rate and duration control. This may be accomplished by providing greater infiltration storage with increased surface ponding and/or aggregate storage volume for storm water flow control.

Recommended Siting Criteria

<i>Siting Criteria</i>	<i>Intent/Rationale</i>
<input type="checkbox"/> Placement observes geotechnical recommendations regarding potential hazards (e.g., slope stability, landslides, liquefaction zones) and setbacks (e.g., slopes, foundations, utilities).	Must not negatively impact existing site geotechnical concerns.
<input type="checkbox"/> Selection and design of basin is based on infiltration feasibility criteria and appropriate design infiltration rate (See Appendix C and D).	Must operate as a full infiltration design and must be supported by drainage area and in-situ infiltration rate feasibility findings.
<input type="checkbox"/> Contributing tributary area is ≤ 5 acres (≤ 1 acre preferred).	Bigger BMPs require additional design features for proper performance. Contributing tributary area greater than 5 acres may be allowed at the discretion of the Authority if the following conditions are met: 1) incorporate design features (e.g., flow spreaders) to minimizing short circuiting of flows in the BMP and 2) incorporate additional design features requested by the Authority for proper performance of the regional BMP.
<input type="checkbox"/> Finish grade of the facility is $\leq 2\%$. In long bioretention facilities where the potential for internal erosion and channelization exists, the use of check dams is required.	Flatter surfaces reduce erosion and channelization within the facility. Internal check dams reduce velocity and dissipate energy.

Recommended BMP Component Dimensions

<i>BMP Component</i>	<i>Dimension</i>	<i>Intent/Rationale</i>
Freeboard	≥ 2 inches	Freeboard provides room for headover overflow structures and minimizes risk of uncontrolled surface discharge.
Surface Ponding	≥ 6 and ≤ 12 inches	Surface ponding capacity lowers subsurface storage requirements. Deep surface ponding raises safety concerns. Surface ponding depth greater than 12 inches (for additional pollutant control or surface outlet structures or flow-control orifices) may be allowed at the discretion of the Authority if the following conditions are met: 1) surface ponding depth drawdown time is less than 24 hours; and 2) safety issues and fencing requirements are considered (typically ponding greater than 18" will require a fence and/or flatter side slopes) and 3) potential for elevated clogging risk is considered.
Ponding Area Side Slopes	$\geq 3H:1V$	Gentler side slopes are safer, less prone to erosion, able to establish vegetation more quickly and easier to maintain.
Mulch	≥ 3 inches	Mulch will suppress weeds and maintain moisture for plant growth. Aging mulch kills pathogens and weed seeds and allows beneficial microbes to multiply.
Media Layer	≥ 18 inches	A deep media layer provides additional filtration and supports plants with deeper roots. Standard specifications shall be followed.

Design Criteria and Considerations

Bioretention must meet the following design criteria. Deviations from the below criteria may be approved at the discretion of the Authority if it is determined to be appropriate:

<i>Design Criteria</i>	<i>Intent/Rationale</i>
Surface Ponding	
<input type="checkbox"/> Surface ponding is limited to a 24-hour drawdown time.	24-hour drawdown time is recommended for plant health. Surface ponding drawdown time greater than 24-hours but less than 96 hours may be allowed at the discretion of the Authority if certified by a landscape architect or agronomist.
Vegetation	
<input type="checkbox"/> Plantings are suitable for the climate and expected ponding depth. A plant list to aid in selection can be found in Appendix E.23.	Plants suited to the climate and ponding depth are more likely to survive.
<input type="checkbox"/> An irrigation system with a connection to water supply is provided as needed.	Seasonal irrigation might be needed to keep plants healthy.
Mulch (Optional)	
<input type="checkbox"/> A minimum of 3 inches of well-aged, shredded hardwood mulch that has been stockpiled or stored for at least 12 months is provided. Mulch must be non-floating to avoid clogging of overflow structure.	Mulch will suppress weeds and maintain moisture for plant growth. Aging mulch kills pathogens and weed seeds and allows beneficial microbes to multiply.
Media Layer	
<input type="checkbox"/> Media maintains a minimum filtration rate of 5 inches/hour over lifetime of facility. A minimum initial filtration rate of 10 inches/hour is recommended.	A high filtration rate through the soil mix minimizes clogging potential and allows flows to quickly enter the aggregate storage layer, thereby minimizing bypass.
<input type="checkbox"/> Media is a minimum 18 inches deep, meeting either of these two media specifications: Section F.3 Bioretention Soil Media (BSM) or specific jurisdictional guidance.	A deep media layer provides additional filtration and supports plants with deeper roots. Standard specifications shall be followed.
<input type="checkbox"/> Alternatively, for proprietary designs and custom media mixes not meeting the media specifications, the media meets the pollutant treatment performance criteria in Section F.1.	For non-standard or proprietary designs, compliance with F.1 ensures that adequate treatment performance will be provided.

<i>Design Criteria</i>	<i>Intent/Rationale</i>
<input type="checkbox"/> Media surface area is 3% of contributing area times adjusted runoff factor or greater. Unless demonstrated that the BMP surface area can be smaller than 3%	<p>Greater surface area to tributary area ratios decreases loading rates per ft² and therefore increase longevity.</p> <p>Adjusted runoff factor is to account for site design BMPs implemented upstream of the BMP (such as rain barrels, impervious area dispersion, etc.). Refer to Appendix B.2 guidance.</p>
<i>Filter Course Layer (Optional)</i>	
<input type="checkbox"/> A filter course is used to prevent migration of fines through layers of the facility. Filter fabric is not used.	<p>Migration of media can cause clogging of the aggregate storage layer void spaces or subgrade. Filter fabric is more likely to clog.</p>
<input type="checkbox"/> Filter course is washed and free of fines.	<p>Washing aggregate will help eliminate fines that could clog the facility and impede infiltration.</p>
<input type="checkbox"/> Filter course calculations assessing suitability for particle migration prevention have been completed.	<p>Gradation relationship between layers can evaluate factors (e.g., bridging, permeability, and uniformity) to determine if particle sizing is appropriate or if an intermediate layer is needed.</p>
<i>Aggregate storage Layer (Optional)</i>	
<input type="checkbox"/> Class 2 Permeable per Caltrans specification 68-1.025 is recommended for the storage layer. Washed, open-graded crushed rock may be used, however a 4-6 inch washed pea gravel filter course layer at the top of the crushed rock is required.	<p>Washing aggregate will help eliminate fines that could clog the aggregate storage layer void spaces or subgrade.</p>
<input type="checkbox"/> Maximum aggregate storage layer depth is determined based on the infiltration storage volume that will infiltrate within a 36-hour drawdown time.	<p>A maximum drawdown time to facilitate provision of adequate storm water storage for the next storm event.</p>
<i>Inflow and Overflow Structures</i>	
<input type="checkbox"/> Inflow and overflow structures are accessible for inspection and maintenance. Overflow structures must be connected to downstream storm drain system or appropriate discharge point.	<p>Maintenance will prevent clogging and ensure proper operation of the flow control structures.</p>
<input type="checkbox"/> Inflow velocities are limited to 3 ft/s or less or use energy dissipation methods (e.g., riprap, level spreader) for concentrated inflows.	<p>High inflow velocities can cause erosion, scour and/or channeling.</p>

<i>Design Criteria</i>	<i>Intent/Rationale</i>
<input type="checkbox"/> Curb cut inlets are at least 12 inches wide, have a 4-6 inch reveal (drop) and an apron and energy dissipation as needed.	Inlets must not restrict flow and apron prevents blockage from vegetation as it grows in. Energy dissipation prevents erosion.
<input type="checkbox"/> Overflow is safely conveyed to a downstream storm drain system or discharge point. Size overflow structure to pass 100-year peak flow for on-line basins and water quality peak flow for off-line basins.	Planning for overflow lessens the risk of property damage due to flooding.

Conceptual Design and Sizing Approach for Storm Water Pollutant Control Only

To design bioretention for storm water pollutant control only (no flow control required), the following steps should be taken:

- 1) Verify that siting and design criteria have been met, including placement and basin area requirements, maximum side and finish grade slope, and the recommended media surface area tributary ratio.
- 2) Calculate the DCV per Appendix B based on expected site design runoff for tributary areas.
- 3) Use the sizing worksheet to determine if full infiltration of the DCV is achievable based on the available infiltration storage volume calculated from the bioretention without underdrain footprint area, effective depths for surface ponding, media and aggregate storage layers, and in-situ soil design infiltration rate for a maximum 36-hour drawdown time for the aggregate storage layer, with surface ponding no greater than a maximum 24-hour drawdown. The drawdown time can be estimated by dividing the average depth of the basin by the design infiltration rate of the underlying soil. Appendix D provides guidance on evaluating a site's infiltration rate. A generic sizing worksheet is provided in Appendix B.4.
- 4) Where the DCV cannot be fully infiltrated based on the site or bioretention constraints, an underdrain can be added to the design (use biofiltration with partial retention factsheet).

Conceptual Design and Sizing Approach when Storm Water Flow Control is Applicable

If control of flow rates and/or durations is desired on an Authority project, significant surface ponding and/or aggregate storage volumes will typically be required, and therefore the following steps should be taken prior to determination of storm water pollutant control design. Pre-development and post-project flow rates and durations shall be determined as discussed in Chapter 6 of the Copermittees' original Model BMP Design Manual. (As previously indicated in this Manual, development within Authority jurisdiction is not subject to hydromodification management requirements, however this sub-section remains as a reference).

- 1) Verify that siting and design criteria have been met, including placement requirements, maximum side and finish grade slopes, and the recommended media surface area tributary area ratio. Design for flow control can be achieved using various design configurations.

Appendix E: BMP Design Fact Sheets

- 2) Iteratively determine the facility footprint area, surface ponding and/or aggregate storage layer depth required to provide infiltration storage to reduce flow rates and durations to allowable limits while adhering to the maximum drawdown times for surface ponding and aggregate storage. Flow rates and durations can be controlled using flow splitters that route the appropriate inflow amounts to the bioretention facility and bypass excess flows to the downstream storm drain system or discharge point.
- 3) If bioretention without underdrain facility cannot fully provide the flow rate and duration control required by the MS4 permit, an upstream or downstream structure with appropriate storage volume such as an underground vault can be used to provide additional control.
- 4) After bioretention without underdrain BMPs have been designed to meet flow control requirements, calculations must be completed to verify if storm water pollutant control requirements to treat the DCV have been met.

Maintenance Overview

Normal Expected Maintenance. Bioretention requires routine maintenance to: remove accumulated materials such as sediment, trash or debris; maintain vegetation health; maintain infiltration capacity of the media layer; replenish mulch; and maintain integrity of side slopes, inlets, energy dissipators, and outlets. A summary table of standard inspection and maintenance indicators is provided within this Fact Sheet.

Non-Standard Maintenance or BMP Failure. If any of the following scenarios are observed, the BMP is not performing as intended to protect downstream waterways from pollution and/or erosion. Corrective maintenance, increased inspection and maintenance, BMP replacement, or a different BMP type will be required.

- The BMP is not drained between storm events. Surface ponding longer than approximately 24 hours following a storm event may be detrimental to vegetation health, and surface ponding longer than approximately 96 hours following a storm event poses a risk of vector (mosquito) breeding. Poor drainage can result from clogging of the media layer, filter course, aggregate storage layer, underlying native soils, or outlet structure. The specific cause of the drainage issue must be determined and corrected. If it is determined that the underlying native soils have been compacted or do not have the infiltration capacity expected, the Authority shall be contacted prior to any additional repairs or reconstruction.
- Sediment, trash, or debris accumulation greater than 25 percent of the surface ponding volume within one month. This means the load from the tributary drainage area is too high, reducing BMP function or clogging the BMP. This would require pretreatment measures within the tributary area draining to the BMP to intercept the materials. Pretreatment components, especially for sediment, will extend the life of components that are more expensive to replace such as media, filter course, and aggregate layers.
- Erosion due to concentrated storm water runoff flow that is not readily corrected by adding erosion control blankets, adding stone at flow entry points, or minor re-grading to restore proper drainage according to the original plan. If the issue is not corrected by restoring the BMP to the original plan and grade, the Authority shall be contacted prior to any additional repairs or reconstruction.

Other Special Considerations. Bioretention is a vegetated structural BMP. Vegetated structural BMPs that are constructed in the vicinity of, or connected to, an existing jurisdictional water or wetland could inadvertently result in creation of expanded waters or wetlands. As such, vegetated structural BMPs have the potential to come under the jurisdiction of the United States Army Corps of Engineers, SDRWQCB, California Department of Fish and Wildlife, or the United States Fish and Wildlife Service. This could result in the need for specific resource agency permits and costly mitigation to perform maintenance of the structural BMP. Along with proper placement of a structural BMP, routine maintenance is key to preventing this scenario.

Summary of Standard Inspection and Maintenance

The property owner is responsible to ensure inspection, operation, and maintenance of permanent BMPs on their property unless responsibility has been formally transferred to the Authority.

Maintenance frequencies listed in this table are average/typical frequencies. Actual maintenance needs are site-specific, and maintenance may be required more frequently. Maintenance must be performed whenever needed, based on maintenance indicators presented in this table. The BMP owner is responsible for conducting regular inspections to see when maintenance is needed based on the maintenance indicators. During the first year of operation of a structural BMP, inspection is recommended at least once prior to August 31 and then monthly from September through May. Inspection during a storm event is also recommended. After the initial period of frequent inspections, the minimum inspection and maintenance frequency can be determined based on the results of the first-year inspections.

Threshold/Indicator	Maintenance Action	Typical Maintenance Frequency
Accumulation of sediment, litter, or debris at the inlet	Remove and properly dispose of accumulated materials.	<ul style="list-style-type: none"> Inspect monthly and after every 0.5-inch or larger storm event. Remove any accumulated materials found at each inspection.
Outlet blocked	Clear blockage.	<ul style="list-style-type: none"> Inspect monthly and after every 0.5-inch or larger storm event. Remove any accumulated materials found at each inspection.

Appendix E: BMP Design Fact Sheets

Threshold/Indicator	Maintenance Action	Typical Maintenance Frequency
Accumulation of sediment, litter, or debris in the storage container	Remove and properly dispose of accumulated materials.	<ul style="list-style-type: none"> • Inspect monthly. If the BMP is 25% full* or more in one month, increase inspection frequency to monthly plus after every 0.1-inch or larger storm event. • Remove materials annually (minimum), or more frequently when BMP is 25% full* (or at manufacturer threshold if manufacturer threshold is less than 25% full*) in less than one year, or if • accumulation blocks outlet
Damage to structural components such as weirs, inlet or outlet structures	Repair or replace as applicable.	<ul style="list-style-type: none"> • Inspect annually. • Maintain when needed.
Poor vegetation establishment	Re-seed, re-plant, or re-establish vegetation per original plans.	<ul style="list-style-type: none"> • Inspect monthly. • Maintain when needed.
Dead or diseased vegetation	Remove dead or diseased vegetation, re-seed, re-plant, or re-establish vegetation per original plans.	<ul style="list-style-type: none"> • Inspect monthly. • Maintain when needed.
Overgrown vegetation	Mow or trim as appropriate.	<ul style="list-style-type: none"> • Inspect monthly. • Maintain when needed.
2/3 of mulch has decomposed, or mulch has been removed	Remove decomposed fraction and top off with fresh mulch to a total depth of 3 inches.	<ul style="list-style-type: none"> • Inspect monthly. • Replenish mulch annually, or more frequently when needed based on inspection.
Erosion due to concentrated irrigation flow	Repair/re-seed/re-plant eroded areas and adjust the irrigation system.	<ul style="list-style-type: none"> • Inspect monthly. • Maintain when needed.

Appendix E: BMP Design Fact Sheets

Threshold/Indicator	Maintenance Action	Typical Maintenance Frequency
Erosion due to concentrated storm water runoff flow	Repair/re-seed/re-plant eroded areas and make appropriate corrective measures such as adding erosion control blankets, adding stone at flow entry points, or minor re-grading to restore proper drainage according to the original plan. If the issue is not corrected by restoring the BMP to the original plan and grade, the Authority shall be contacted prior to any additional repairs or reconstruction.	<ul style="list-style-type: none"> • Inspect after every 0.5-inch or larger storm event. If erosion due to storm water flow has been observed, increase inspection frequency to after every 0.1-inch or larger storm event. • Maintain when needed. If the issue is not corrected by restoring the BMP to the original plan and grade, the Authority shall be contacted prior to any additional repairs or reconstruction.
Standing water in BMP for longer than 24 hours following a storm event Surface ponding longer than approximately 24 hours following a storm event may be detrimental to vegetation health	Make appropriate corrective measures such as adjusting irrigation system, removing obstructions of debris or invasive vegetation, or repairing/replacing clogged or compacted soils. If it is determined that the underlying native soils have been compacted or do not have the infiltration capacity expected, the Authority shall be contacted prior to any additional repairs or reconstruction.	<ul style="list-style-type: none"> • Inspect monthly and after every 0.5-inch or larger storm event. If standing water is observed, increase inspection frequency to after every 0.1-inch or larger storm event. • Maintain when needed.

Threshold/Indicator	Maintenance Action	Typical Maintenance Frequency
<p>Presence of mosquitos/larvae</p> <p>For images of egg rafts, larva, pupa, and adult mosquitos, see http://www.mosquito.org/biology</p>	<p>If mosquitos/larvae are observed: first, immediately remove any standing water by dispersing to nearby landscaping; second, make corrective measures as applicable to restore BMP drainage to prevent standing water.</p> <p>If mosquitos persist following corrective measures to remove standing water, or if the BMP design does not meet the 96-hour drawdown criteria because the underlying native soils have been compacted or do not have the infiltration capacity expected, the Authority shall be contacted to determine a solution. A different BMP type, or a Vector Management Plan prepared with concurrence from the County of San Diego Department of Environmental Health, may be required.</p>	<ul style="list-style-type: none"> • Inspect monthly and after every 0.5-inch or larger storm event. If mosquitos are observed, increase inspection frequency to after every 0.1-inch or larger storm event. • Maintain when needed.

“25% full” is defined as ¼ of the depth from the design bottom elevation to the crest of the outflow structure (e.g., if the height to the outflow opening is 12 inches from the bottom elevation, then the materials must be removed when there is 3 inches of accumulation – this should be marked on the outflow structure).

E.13 INF-3 Permeable Pavement (Pollutant Control)



Location: Kellogg Park, San Diego, California

Description

Permeable pavement is pavement that allows for percolation through void spaces in the pavement surface into subsurface layers. The subsurface layers are designed to provide storage of storm water runoff so that outflows, primarily via infiltration into subgrade soils or release to the downstream conveyance system, can be at controlled rates. Varying levels of storm water treatment and flow control can be provided depending on the size of the permeable pavement system relative to its drainage area, the underlying infiltration rates, and the configuration of outflow controls. Pollutant control permeable pavement is designed to receive runoff from a larger tributary area than site design permeable pavement (see SD-D). Pollutant control is provided via infiltration, filtration, sorption, sedimentation, and biodegradation processes.

Typical permeable pavement components include, from top to bottom:

- Permeable surface layer
- Bedding layer for permeable surface
- Aggregate storage layer with optional underdrain(s)
- Optional final filter course layer over uncompacted existing subgrade

MS4 Permit Category

Retention
Flow-through Treatment
Control

Manual Category

Infiltration
Flow-through Treatment
Control

Applicable Performance Standard

Pollutant Control
Flow Control

Primary Benefits

Volume Reduction
Peak Flow Attenuation

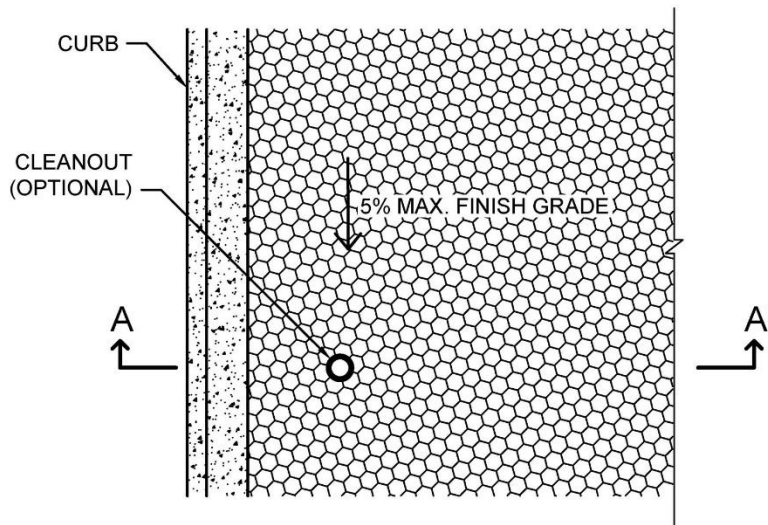

PLAN
NOT TO SCALE

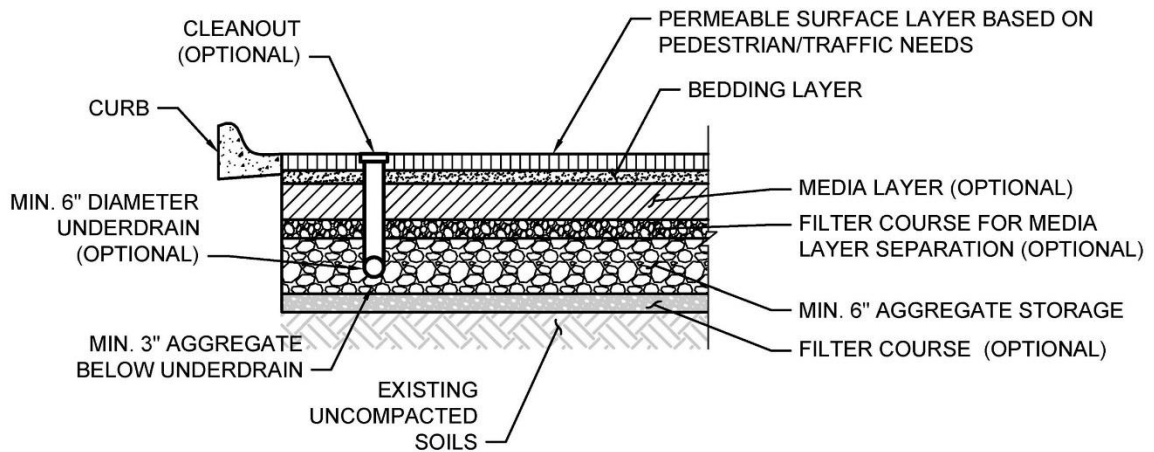

SECTION A-A'
NOT TO SCALE

Typical Plan and Section View of a Permeable Pavement BMP

Subcategories of permeable pavement include modular paver units or paver blocks, pervious concrete, porous asphalt, and turf pavers. These subcategory variations differ in the material used for the permeable surface layer but have similar functions and characteristics below this layer.

Design Adaptations for Project Goals

Site design BMP to reduce impervious area and DCV. See site design option SD-D.

Full infiltration BMP for storm water pollutant control. Permeable pavement without an underdrain and without impermeable liners can be used as a pollutant control BMP, designed to infiltrate runoff from direct rainfall as well as runoff from adjacent areas that are tributary to the pavement. The system must be designed with an infiltration storage volume (a function of the aggregate storage volume) equal to the full DCV and able to meet drawdown time limitations.

Partial infiltration BMP with flow-through treatment for storm water pollutant control. Permeable pavement can be designed so that a portion of the DCV is infiltrated by providing an underdrain with infiltration storage below the underdrain invert. The infiltration storage depth should be determined by the volume that can be reliably infiltrated within drawdown time limitations. Water discharged through the underdrain is considered flow-through treatment and is not considered biofiltration treatment. Storage provided above the underdrain invert is included in the flow-through treatment volume.

Flow-through treatment BMP for storm water pollutant control. The system may be lined and/or installed over impermeable native soils with an underdrain provided at the bottom to carry away filtered runoff. Water quality treatment is provided via unit treatment processes other than infiltration. This configuration is considered to provide flow-through treatment, not biofiltration treatment. Significant aggregate storage provided above the underdrain invert can provide detention storage, which can be controlled via inclusion of an orifice in an outlet structure at the downstream end of the underdrain. PDPs have the option to add saturated storage to the flow-through configuration in order to reduce the DCV that the BMP is required to treat. Saturated storage can be added to this design by including an upturned elbow installed at the downstream end of the underdrain or via an internal weir structure designed to maintain a specific water level elevation. The DCV can be reduced by the amount of saturated storage provided.

Integrated storm water flow control and pollutant control configuration. With any of the above configurations, the system can be designed to provide flow rate and duration control. This may include having a deeper aggregate storage layer that allows for significant detention storage above the underdrain, which can be further controlled via inclusion of an outlet structure at the downstream end of the underdrain.

Recommended Siting Criteria

<i>Siting Criteria</i>	<i>Intent/Rationale</i>
<input type="checkbox"/> Placement observes geotechnical recommendations regarding potential hazards (e.g., slope stability, landslides, liquefaction zones) and setbacks (e.g., slopes, foundations, utilities).	Must not negatively impact existing site geotechnical concerns.

<i>Siting Criteria</i>	<i>Intent/Rationale</i>
<input type="checkbox"/> Selection must be based on infiltration feasibility criteria.	Full or partial infiltration designs must be supported by drainage area feasibility findings.
<input type="checkbox"/> Permeable pavement is not placed in an area with significant overhanging trees or other vegetation.	Leaves and organic debris can clog the pavement surface.
<input type="checkbox"/> Minimum depth to groundwater and bedrock ≥ 10 ft.	A minimum separation facilitates infiltration and lessens the risk of negative groundwater impacts.
<input type="checkbox"/> Contributing tributary area includes effective sediment source control and/or pretreatment measures such as raised curbed or grass filter strips.	Sediment can clog the pavement surface.
<input type="checkbox"/> Direct discharges to permeable pavement are only from downspouts carrying “clean” roof runoff that are equipped with filters to remove gross solids.	Roof runoff typically carries less sediment than runoff from other impervious surfaces and is less likely to clog the pavement surface.

Recommended BMP Component Dimensions

<i>BMP Component</i>	<i>Dimension</i>	<i>Intent/Rationale</i>
Bedding Layer	1-2 inches (typical)	Bedding (e.g., sand, aggregate) provided to stabilize and level the surface.
Aggregate Storage	≥ 6 inches	A minimum depth of aggregate provides structural stability for expected pavement loads.
Underdrain Diameter	≥ 6 inches	Smaller diameter underdrains are prone to clogging.

Design Criteria and Considerations

Permeable pavements must meet the following design criteria. Deviations from the below criteria may be approved at the discretion of the Authority if it is determined to be appropriate:

<i>Design Criteria</i>	<i>Intent/Rationale</i>
<input type="checkbox"/> An impermeable liner or other hydraulic restriction layer is included if site constraints indicate that infiltration should not be allowed.	Lining prevents storm water from impacting groundwater and/or sensitive environmental or geotechnical features. Incidental infiltration, when allowable, can aid in pollutant removal and groundwater recharge.
<input type="checkbox"/> For pollutant control permeable pavement, the ratio of the total drainage area (including the permeable pavement) to the permeable pavement should not exceed 4:1.	Higher ratios increase the potential for clogging but may be acceptable for relatively clean tributary areas.

<i>Design Criteria</i>	<i>Intent/Rationale</i>
<input type="checkbox"/> Finish grade of the permeable pavement has a slope $\leq 5\%$.	Flatter surfaces facilitate increased runoff capture.
<i>Permeable Surface Layer</i>	
<input type="checkbox"/> Permeable surface layer type is appropriately chosen based on pavement use and expected vehicular loading.	Pavement may wear more quickly if not durable for expected loads or frequencies.
<input type="checkbox"/> Permeable surface layer type is appropriate for expected pedestrian traffic.	Expected demographic and accessibility needs (e.g., adults, children, seniors, runners, high-heeled shoes, wheelchairs, strollers, bikes) requires selection of appropriate surface layer type that will not impede pedestrian needs.
<i>Bedding Layer for Permeable Surface</i>	
<input type="checkbox"/> Bedding thickness and material is appropriate for the chosen permeable surface layer type.	<p>Porous asphalt requires a 2- to 4-inch layer of asphalt and a 1- to 2-inch layer of choker course (single-sized crushed aggregate, one-half inch) to stabilize the surface.</p> <p>Pervious concrete also requires an aggregate course of clean gravel or crushed stone with a minimum number of fines.</p> <p>Permeable Interlocking Concrete Paver requires 1 or 2 inches of sand or No. 8 aggregate to allow for leveling of the paver blocks.</p> <p>Similar to Permeable Interlocking Concrete Paver, plastic grid systems also require a 1- to 2-inch bedding course of either gravel or sand.</p> <p>For Permeable Interlocking Concrete Paver and plastic grid systems, if sand is used, a geotextile should be used between the sand course and the reservoir media to prevent the sand from migrating into the stone media.</p>
<input type="checkbox"/> Aggregate used for bedding layer is washed prior to placement.	Washing aggregate will help eliminate fines that could clog the permeable pavement system aggregate storage layer void spaces or underdrain.
<i>Media Layer (Optional) –used between bedding layer and aggregate storage layer to provide pollutant treatment control</i>	
<input type="checkbox"/> The pollutant removal performance of the media layer is documented by the applicant.	Media used for BMP design should be shown via research or testing to be appropriate for expected pollutants of concern and flow rates.

<i>Design Criteria</i>	<i>Intent/Rationale</i>
<input type="checkbox"/> A filter course is provided to separate the media layer from the aggregate storage layer.	Migration of media can cause clogging of the aggregate storage layer void spaces or underdrain.
<input type="checkbox"/> If a filter course is used, calculations assessing suitability for particle migration prevention have been completed.	Gradation relationship between layers can evaluate factors (e.g., bridging, permeability, and uniformity) to determine if particle sizing is appropriate or if an intermediate layer is needed.
<input type="checkbox"/> Consult permeable pavement manufacturer to verify that media layer provides required structural support.	Media must not compromise the structural integrity or intended uses of the permeable pavement surface.
<i>Aggregate Storage Layer</i>	
<input type="checkbox"/> Aggregate used for the aggregate storage layer is washed and free of fines.	Washing aggregate will help eliminate fines that could clog aggregate storage layer void spaces or underdrain.
<input type="checkbox"/> Minimum layer depth is 6 inches and for infiltration designs, the maximum depth is determined based on the infiltration storage volume that will infiltrate within a 36-hour drawdown time.	A minimum depth of aggregate provides structural stability for expected pavement loads.
<i>Underdrain and Outflow Structures</i>	
<input type="checkbox"/> Underdrains and outflow structures, if used, are accessible for inspection and maintenance.	Maintenance will improve the performance and extend the life of the permeable pavement system.
<input type="checkbox"/> Underdrain outlet elevation should be a minimum of 3 inches above the bottom elevation of the aggregate storage layer.	A minimal separation from subgrade or the liner lessens the risk of fines entering the underdrain and can improve hydraulic performance by allowing perforations to remain unblocked.
<input type="checkbox"/> Minimum underdrain diameter is 6 inches.	Smaller diameter underdrains are prone to clogging.
<input type="checkbox"/> Underdrains are made of slotted, PVC pipe conforming to ASTM D 3034 or equivalent or corrugated, HDPE pipe conforming to AASHTO 252M or equivalent.	Slotted underdrains provide greater intake capacity, clog resistant drainage, and reduced entrance velocity into the pipe, thereby reducing the chances of solids migration.
<i>Filter Course (Optional)</i>	
<input type="checkbox"/> Filter course is washed and free of fines.	Washing aggregate will help eliminate fines that could clog subgrade and impede infiltration.

Conceptual Design and Sizing Approach for Site Design

- 1) Determine the areas where permeable pavement can be used in the site design to replace traditional pavement to reduce the impervious area and DCV. These permeable pavement areas can be credited toward reducing runoff generated through representation in storm water calculations as pervious, not impervious, areas but are not credited for storm water pollutant control. These permeable pavement areas should be designed as self-retaining with the appropriate tributary area ratio identified in the design criteria.
- 2) Calculate the DCV per Appendix B, taking into account reduced runoff from self-retaining permeable pavement areas.

Conceptual Design and Sizing Approach for Storm Water Pollutant Control Only

To design permeable pavement for storm water pollutant control only (no flow control required), the following steps should be taken:

- 1) Verify that siting and design criteria have been met, including placement requirements, maximum finish grade slope, and the recommended tributary area ratio for non-self-retaining permeable pavement. If infiltration is infeasible, the permeable pavement can be designed as flow-through treatment per the sizing worksheet. If infiltration is feasible, calculations should follow the remaining design steps.
- 2) Calculate the DCV per Appendix B based on expected site design runoff for tributary areas.
- 3) Use the sizing worksheet to determine if full or partial infiltration of the DCV is achievable based on the available infiltration storage volume calculated from the permeable pavement footprint, aggregate storage layer depth, and in-situ soil design infiltration rate for a maximum 36-hour drawdown time. The applicant has an option to use a different drawdown time up to 96 hours if the volume of the facility is adjusted using the percent capture method in Appendix B.4.2.
- 4) Where the DCV cannot be fully infiltrated based on the site or permeable pavement constraints, an underdrain must be incorporated above the infiltration storage to carry away runoff that exceeds the infiltration storage capacity.
- 5) The remaining DCV to be treated should be calculated for use in sizing downstream BMP(s).

Conceptual Design and Sizing Approach when Storm Water Flow Control is Applicable

If control of flow rates and/or durations is desired on an Authority project, significant aggregate storage volumes will typically be required, and therefore the following steps should be taken prior to determination of storm water pollutant control design. Pre-development and post-project flow rates and durations should be determined as discussed in Chapter 6 of the Copermittees' original Model BMP Design Manual. (As previously indicated in this Manual, development within Authority jurisdiction is not subject to hydromodification management requirements, however this sub-section remains as a reference).

- 1) Verify that siting and design criteria have been met, including placement requirements, maximum finish grade slope, and the recommended tributary area ratio for non-self-retaining permeable pavement. Design for flow control can be achieved using various design configurations, but a flow-thru treatment design will typically require a greater aggregate storage layer volume than designs which allow for full or partial infiltration of the DCV.
- 2) Iteratively determine the area and aggregate storage layer depth required to provide infiltration and/or detention storage to reduce flow rates and durations to allowable limits. Flow rates and durations can be controlled from detention storage by altering outlet structure orifice size(s) and/or water control levels. Multi-level orifices can be used within an outlet structure to control the full range of flows.
- 3) If the permeable pavement system cannot fully provide the flow rate and duration control required by this Manual, a downstream structure with sufficient storage volume such as an underground vault can be used to provide remaining controls.
- 4) After permeable pavement has been designed to meet flow control requirements, calculations must be completed to verify if storm water pollutant control requirements to treat the DCV have been met.

Maintenance Overview

Normal Expected Maintenance. Routine maintenance of permeable pavement includes: removal of materials such as trash and debris accumulated on the paving surface; vacuuming of the paving surface to prevent clogging; and flushing paving and subsurface gravel to remove fine sediment. If the BMP includes underdrains and/or an outflow control structure, check and clear these features.

Non-Standard Maintenance or BMP Failure. If the permeable pavement area is not drained between storm events, or if runoff sheet flows across the permeable pavement area and flows off the permeable pavement area during storm events, the BMP is not performing as intended to protect downstream waterways from pollution and/or erosion. During storm events up to the 85th percentile storm event (approximately 0.5 to 1 inch of rainfall in San Diego County), runoff should not flow off the permeable pavement area. The permeable pavement area is expected to have adequate hydraulic conductivity and storage such that rainfall landing on the permeable pavement and runoff from the surrounding drainage area will go directly into the pavement without ponding or overflow (in properly designed systems, the surrounding drainage area is not more than half as large as the permeable pavement area). Following the storm event, there should be no standing water (puddles) on the permeable pavement area.

If storm water is flowing off the permeable pavement during a storm event, or if there is standing water on the permeable pavement surface following a storm event, this is an indicator of clogging somewhere within the system. Poor drainage can result from clogging of the permeable surface layer, any of the subsurface components, or the subgrade soils. The specific cause of the drainage issue must be determined and corrected. Surface or subsurface ponding longer than approximately 96 hours following a storm event poses a risk of vector (mosquito) breeding. Corrective maintenance, increased inspection and maintenance, BMP replacement, or a different BMP type will be required. If poor drainage persists after flushing of the paving, subsurface gravel, and/or underdrain(s) when applicable, or if it is determined that the underlying soils do not have the infiltration capacity expected, the Authority shall be contacted prior to any additional repairs or reconstruction.

Appendix E: BMP Design Fact Sheets

Other Special Considerations. The runoff storage and infiltration surface area in this BMP are not readily accessible because they are subsurface. This means that clogging and poor drainage are not easily corrected. If the tributary area draining to the BMP includes unpaved areas, the sediment load from the tributary drainage area can be too high, reducing BMP function or clogging the BMP. All unpaved areas within the tributary drainage area should be stabilized with vegetation. Other pretreatment components to prevent transport of sediment to the paving surface, such as grass buffer strips, will extend the life of the subsurface components and infiltration surface. Along with proper stabilization measures and pretreatment within the tributary area, routine maintenance, including preventive vacuum/regenerative air street sweeping, is key to preventing clogging.

This page intentionally left blank

Summary of Standard Inspection and Maintenance

The property owner is responsible to ensure inspection, operation and maintenance of permanent BMPs on their property unless responsibility has been formally transferred to the Authority.

Maintenance frequencies listed in this table are average/typical frequencies. Actual maintenance needs are site-specific, and maintenance may be required more frequently. Maintenance must be performed whenever needed, based on maintenance indicators presented in this table. The BMP owner is responsible for conducting regular inspections to see when maintenance is needed based on the maintenance indicators. During the first year of operation of a structural BMP, inspection is recommended at least once prior to August 31 and then monthly from September through May. Inspection during a storm event is also recommended. After the initial period of frequent inspections, the minimum inspection and maintenance frequency can be determined based on the results of the first-year inspections.

Threshold/Indicator	Maintenance Action	Typical Maintenance Frequency
Preventive vacuum/regenerative air street sweeping	Pavement should be swept with a vacuum power or regenerative air street sweeper to maintain infiltration through paving surface	<ul style="list-style-type: none"> Schedule/perform this preventive action at least twice per year.
Accumulation of sediment, litter, or debris on permeable pavement surface	Remove and properly dispose of accumulated materials. Inspect tributary area for exposed soil or other sources of sediment and apply stabilization measures to sediment source areas. Apply source control measures as applicable to sources of litter or debris.	<ul style="list-style-type: none"> Inspect monthly and after every 0.5-inch or larger storm event. Remove any accumulated materials found at each inspection.
Weeds growing on/through the permeable pavement surface	Remove weeds and add features as necessary to prevent weed intrusion. Use non-chemical methods (e.g., instead of pesticides, control weeds using mechanical removal, physical barriers, and/or physical changes in the surrounding area adjacent to pavement that will preclude weed intrusion into the pavement).	<ul style="list-style-type: none"> Inspect monthly. Remove any weeds found at each inspection.

Threshold/Indicator	Maintenance Action	Typical Maintenance Frequency
<p>Standing water in permeable paving area or subsurface infiltration gallery for longer than 24-96 hours following a storm event</p>	<p>This condition requires investigation of why infiltration is not occurring. If feasible, corrective action shall be taken to restore infiltration (e.g., pavement should be swept with a vacuum power or regenerative air street sweeper to restore infiltration rates, clear underdrains if underdrains are present). BMP may require retrofit if infiltration cannot be restored. The Authority shall be contacted prior to any repairs or reconstruction.</p>	<ul style="list-style-type: none"> • Inspect monthly and after every 0.5-inch or larger storm event. If standing water is observed, increase inspection frequency to after every 0.1-inch or larger storm event. • Maintain when needed.
<p>Presence of mosquitos/larvae</p> <p>For images of egg rafts, larva, pupa, and adult mosquitos, see http://www.mosquito.org/biology</p>	<p>If mosquitos/larvae are observed: first, immediately remove any standing water by dispersing to nearby landscaping; second, make corrective measures as applicable to restore BMP drainage to prevent standing water.</p> <p>If mosquitos persist following corrective measures to remove standing water, or if the BMP design does not meet the 96-hour drawdown criteria because the underlying native soils have been compacted or do not have the infiltration capacity expected, the Authority shall be contacted to determine a solution. A different BMP type, or a Vector Management Plan prepared with concurrence from the County of San Diego Department of Environmental Health, may be required.</p>	<ul style="list-style-type: none"> • Inspect monthly and after every 0.5-inch or larger storm event. If mosquitos are observed, increase inspection frequency to after every 0.1-inch or larger storm event. • Maintain when needed.

Appendix E: BMP Design Fact Sheets

Threshold/Indicator	Maintenance Action	Typical Maintenance Frequency
Obstructed underdrain or outlet structure (when the BMP includes outflow control structure for runoff released from subsurface storage via underdrain(s))	Clear blockage.	<ul style="list-style-type: none"> • Inspect if standing water is observed for longer than 24-96 hours following a storm event. • Maintain when needed.
Damage to structural components of subsurface infiltration gallery such as weirs or outlet structures	Repair or replace as applicable.	<ul style="list-style-type: none"> • Inspect annually. • Maintain when needed.
Damage to permeable paving surface (e.g., cracks, settlement, misaligned paver blocks, void spaces between paver blocks need fill materials replenished)	Repair or replace damaged surface as appropriate.	<ul style="list-style-type: none"> • Inspect annually. • Maintain when needed.

This page intentionally left blank

E.14 PR-1 Biofiltration with Partial Retention



Location: 805 and Bonita Road, Chula vista, C.A.

MS4 Permit Category

NA

Manual Category

Partial Retention

Applicable Performance Standard

Pollutant Control

Flow Control

Primary Benefits

Volume Reduction

Treatment

Peak Flow Attenuation

Description

Biofiltration with partial retention (partial infiltration and biofiltration) facilities are vegetated surface water systems that filter water through vegetation, and soil or engineered media prior to infiltrating into native soils, discharge via underdrain, or overflow to the downstream conveyance system. Where feasible, these BMPs have an elevated underdrain discharge point that creates storage capacity in the aggregate storage layer. Biofiltration with partial retention facilities are commonly incorporated into the site within parking lot landscaping, along roadsides, and in open spaces. They can be constructed in ground or partially aboveground, such as planter boxes with open bottoms to allow infiltration. Treatment is achieved through filtration, sedimentation, sorption, infiltration, biochemical processes and plant uptake.

Typical biofiltration with partial retention components include:

- Inflow distribution mechanisms (e.g., perimeter flow spreader or filter strips)
- Energy dissipation mechanism for concentrated inflows (e.g., splash blocks or riprap)
- Shallow surface ponding for captured flows
- Side Slope and basin bottom vegetation selected based on climate and ponding depth
- Non-floating mulch layer (Optional)
- Media layer (planting mix or engineered media) capable of supporting vegetation growth
- Filter course layer consisting of aggregate to prevent the migration of fines into uncompacted native soils or the optional aggregate storage layer
- Aggregate storage layer with underdrain(s)
- Uncompacted native soils at the bottom of the facility
- Overflow structure

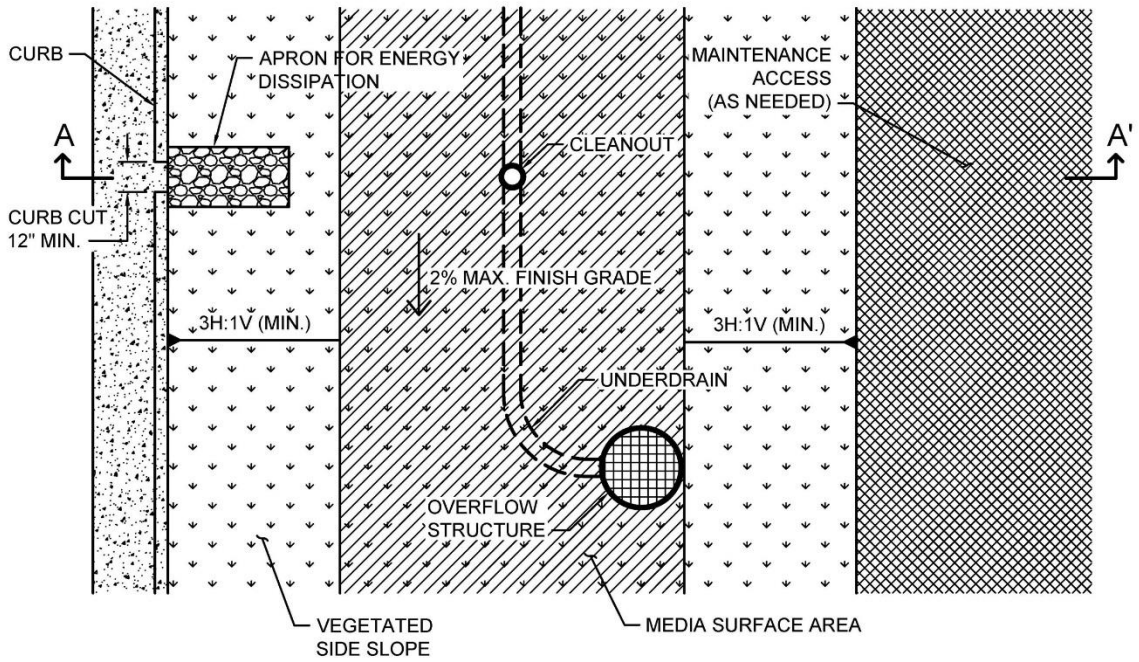

PLAN
NOT TO SCALE

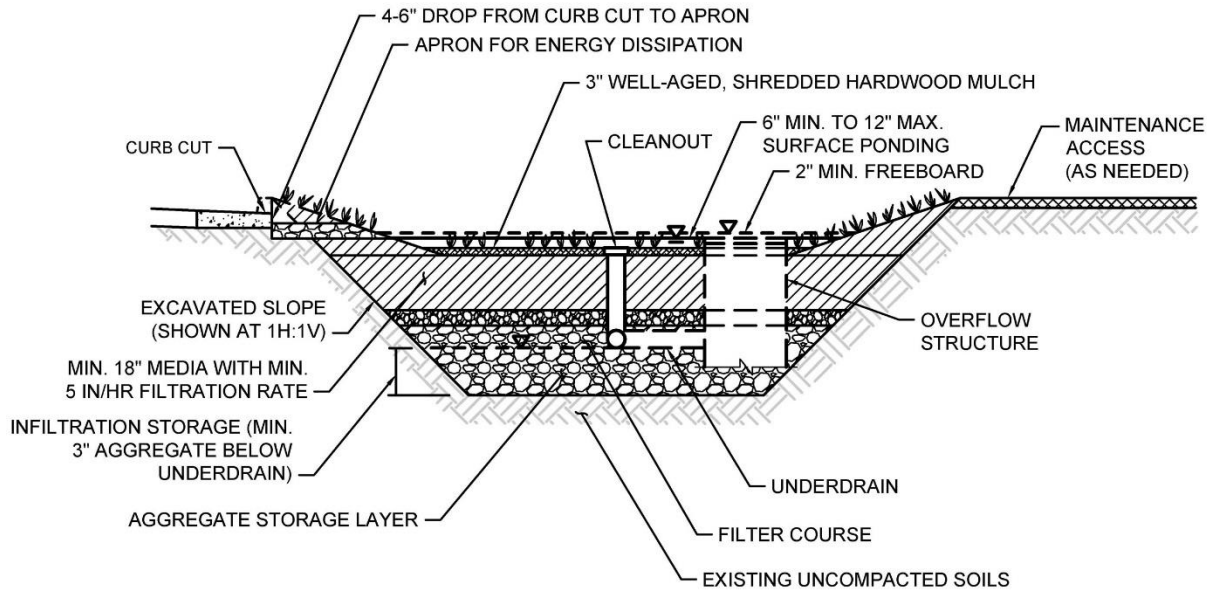

SECTION A-A'
NOT TO SCALE

Typical Plan and Section View of a Biofiltration with Partial Retention BMP

Design Adaptations for Project Goals

Partial infiltration BMP with biofiltration treatment for storm water pollutant control. Biofiltration with partial retention can be designed so that a portion of the DCV is infiltrated by providing infiltration storage below the underdrain invert. The infiltration storage depth should be determined by the volume that can be reliably infiltrated within drawdown time limitations. Water discharged through the underdrain is considered biofiltration treatment. Storage provided above the underdrain within surface ponding, media, and aggregate storage is included in the biofiltration treatment volume.

Integrated storm water flow control and pollutant control configuration. The system can be designed to provide flow rate and duration control by primarily providing increased surface ponding and/or having a deeper aggregate storage layer. This will allow for significant detention storage, which can be controlled via inclusion of an orifice in an outlet structure at the downstream end of the underdrain.

Recommended Siting Criteria

<i>Siting Criteria</i>	<i>Intent/Rationale</i>
<input type="checkbox"/> Placement observes geotechnical recommendations regarding potential hazards (e.g., slope stability, landslides, liquefaction zones) and setbacks (e.g., slopes, foundations, utilities).	Must not negatively impact existing site geotechnical concerns.
<input type="checkbox"/> Selection and design of basin is based on infiltration feasibility criteria and appropriate design infiltration rate (See Appendix C and D).	Must operate as a partial infiltration design and must be supported by drainage area and in-situ infiltration rate feasibility findings.
<input type="checkbox"/> Contributing tributary area shall be \leq 5 acres (\leq 1 acre preferred).	Bigger BMPs require additional design features for proper performance. Contributing tributary area greater than 5 acres may be allowed at the discretion of the Authority if the following conditions are met: 1) incorporate design features (e.g., flow spreaders) to minimizing short circuiting of flows in the BMP and 2) incorporate additional design features requested by the Authority for proper performance of the regional BMP.
<input type="checkbox"/> Finish grade of the facility is \leq 2%.	Flatter surfaces reduce erosion and channelization within the facility.

Recommended BMP Component Dimensions		
<i>BMP Component</i>	<i>Dimension</i>	<i>Intent/Rationale</i>
Freeboard	≥ 2 inches	Freeboard provides room for head over overflow structures and minimizes risk of uncontrolled surface discharge.
Surface Ponding	≥ 6 and ≤ 12 inches	Surface ponding capacity lowers subsurface storage requirements. Deep surface ponding raises safety concerns. Surface ponding depth greater than 12 inches (for additional pollutant control or surface outlet structures or flow-control orifices) may be allowed at the discretion of the Authority if the following conditions are met: 1) surface ponding depth drawdown time is less than 24 hours; and 2) safety issues and fencing requirements are considered (typically ponding greater than 18” will require a fence and/or flatter side slopes) and 3) potential for elevated clogging risk is considered.
Ponding Area Side Slopes	3H:1V or shallower	Gentler side slopes are safer, less prone to erosion, able to establish vegetation more quickly and easier to maintain.
Mulch	≥ 3 inches	Mulch will suppress weeds and maintain moisture for plant growth. Aging mulch kills pathogens and weed seeds and allows the beneficial microbes to multiply.
Media Layer	≥ 18 inches	A deep media layer provides additional filtration and supports plants with deeper roots. Standard specifications shall be followed. For non-standard or proprietary designs, compliance with Appendix F.1 ensures that adequate treatment performance will be provided.
Underdrain Diameter	≥ 6 inches	Smaller diameter underdrains are prone to clogging.

<i>BMP Component</i>	<i>Dimension</i>	<i>Intent/Rationale</i>
Cleanout Diameter	≥ 6 inches	Properly spaced cleanouts will facilitate underdrain maintenance.

Design Criteria and Considerations

Biofiltration with partial retention must meet the following design criteria and considerations. Deviations from the below criteria may be approved at the discretion of the Authority if it is determined to be appropriate:

<i>Design Criteria</i>	<i>Intent/Rationale</i>
<i>Surface Ponding</i>	
<input type="checkbox"/> Surface ponding is limited to a 24-hour drawdown time.	Surface ponding limited to 24 hours for plant health. Surface ponding drawdown time greater than 24-hours but less than 96 hours may be allowed at the discretion of the Authority if certified by a landscape architect or agronomist.
<i>Vegetation</i>	
<input type="checkbox"/> Plantings are suitable for the climate and expected ponding depth. A plant list to aid in selection can be found in Appendix E.23	Plants suited to the climate and ponding depth are more likely to survive.
<i>Design Criteria</i>	<i>Intent/Rationale</i>
<input type="checkbox"/> An irrigation system with a connection to water supply should be provided as needed.	Seasonal irrigation might be needed to keep plants healthy.
<i>Mulch (Optional)</i>	
<input type="checkbox"/> A minimum of 3 inches of well-aged, shredded hardwood mulch that has been stockpiled or stored for at least 12 months is provided. Mulch must be non-floating to avoid clogging of overflow structure.	Mulch will suppress weeds and maintain moisture for plant growth. Aging mulch kills pathogens and weed seeds and allows the beneficial microbes to multiply.
<i>Media Layer</i>	
<input type="checkbox"/> Media maintains a minimum filtration rate of 5 inches/hour over lifetime of facility. An initial filtration rate of 8 to 12 inches/hour is recommended to allow for clogging over time; the initial filtration rate should not exceed 12 inches per hour.	A filtration rate of at least 5 inches per hour allows soil to drain between events and allows flows to relatively quickly enter the aggregate storage layer, thereby minimizing bypass. The initial rate should be higher than long term target rate to account for clogging over time. However, an excessively high initial rate can have a negative impact on treatment performance, therefore an upper limit is needed.

<i>Design Criteria</i>	<i>Intent/Rationale</i>
<p><input type="checkbox"/> Media is a minimum 18 inches deep, meeting either of these two media specifications: City of San Diego Storm Water Standards Appendix F (February 2016, unless superseded by more recent edition) or County of San Diego Low Impact Development Handbook: Appendix G -Bioretention Soil Specification (June 2014, unless superseded by more recent edition). Alternatively, for proprietary designs and custom media mixes not meeting the media specifications contained in the 2016 City Storm Water Standards or County LID Manual, the media meets the pollutant treatment performance criteria in Section F.1.</p>	<p>A deep media layer provides additional filtration and supports plants with deeper roots. Standard specifications shall be followed. For non-standard or proprietary designs, compliance with Appendix F.1 ensures that adequate treatment performance will be provided.</p>
<i>Design Criteria</i>	<i>Intent/Rationale</i>
<p><input type="checkbox"/> Media surface area is 3% of contributing area times adjusted runoff factor or greater. Unless demonstrated that the BMP surface area can be smaller than 3%.</p>	<p>Greater surface area to tributary area ratios: a) maximizes volume retention as required by the MS4 Permit and b) decrease loading rates per ft² and therefore increase longevity. Adjusted runoff factor is to account for site design BMPs implemented upstream of the BMP (such as rain barrels, impervious area dispersion, etc.). Refer to Appendix B.2 guidance. Use Worksheet B.5-1 Line 26 to estimate the minimum surface area required per these criteria.</p>
<p><input type="checkbox"/> Where receiving waters are impaired or have a TMDL for nutrients, the system is designed with nutrient sensitive media design (see fact sheet BF-2).</p>	<p>Potential for pollutant export is partly a function of media composition; media design must minimize potential for export of nutrients, particularly where receiving waters are impaired for nutrients.</p>
<i>Filter Course Layer</i>	<i>Intent/Rationale</i>
<p><input type="checkbox"/> A filter course is used to prevent migration of fines through layers of the facility. Filter fabric is not used.</p>	<p>Migration of media can cause clogging of the aggregate storage layer void spaces or subgrade. Filter fabric is more likely to clog.</p>
<p><input type="checkbox"/> Filter course is washed and free of fines.</p>	<p>Washing aggregate will help eliminate fines that could clog the facility</p>

<i>Design Criteria</i>	<i>Intent/Rationale</i>
<input type="checkbox"/> Filter course calculations assessing suitability for particle migration prevention have been completed.	Gradation relationship between layers can evaluate factors (e.g., bridging, permeability, and uniformity) to determine if particle sizing is appropriate or if an intermediate layer is needed.
<i>Aggregate Storage Layer</i>	
<input type="checkbox"/> Class 2 Permeable per Caltrans specification 68-1.025 is recommended for the storage layer. Washed, open-graded crushed rock may be used, however a 4-6 inch washed pea gravel filter course layer at the top of the crushed rock is required.	Washing aggregate will help eliminate fines that could clog the aggregate storage layer void spaces or subgrade.
<input type="checkbox"/> Maximum aggregate storage layer depth below the underdrain invert is determined based on the infiltration storage volume that will infiltrate within a 36-hour drawdown time.	A maximum drawdown time is needed for vector control and to facilitate providing storm water storage for the next storm event.
<i>Inflow, Underdrain, and Outflow Structures</i>	
<input type="checkbox"/> Inflow, underdrains and outflow structures are accessible for inspection and maintenance.	Maintenance will prevent clogging and ensure proper operation of the flow control structures.
<input type="checkbox"/> Inflow velocities are limited to 3 ft/s or less or use energy dissipation methods. (e.g., riprap, level spreader) for concentrated inflows.	High inflow velocities can cause erosion, scour and/or channeling.
<input type="checkbox"/> Curb cut inlets are at least 12 inches wide, have a 4-6 inch reveal (drop) and an apron and energy dissipation as needed.	Inlets must not restrict flow and apron prevents blockage from vegetation as it grows in. Energy dissipation prevents erosion.
<input type="checkbox"/> Underdrain outlet elevation should be a minimum of 3 inches above the bottom elevation of the aggregate storage layer.	A minimal separation from subgrade or the liner lessens the risk of fines entering the underdrain and can improve hydraulic performance by allowing perforations to remain unblocked.
<input type="checkbox"/> Minimum underdrain diameter is 6 inches.	Smaller diameter underdrains are prone to clogging.
<input type="checkbox"/> Underdrains are made of slotted, PVC pipe conforming to ASTM D 3034 or equivalent or corrugated, HDPE pipe conforming to AASHTO 252M or equivalent.	Slotted underdrains provide greater intake capacity, clog resistant drainage, and reduced entrance velocity into the pipe, thereby reducing the chances of solids migration.

<i>Design Criteria</i>	<i>Intent/Rationale</i>
<input type="checkbox"/> An underdrain cleanout with a minimum 6-inch diameter and lockable cap is placed every 250 to 300 feet as required based on underdrain length.	Properly spaced cleanouts will facilitate underdrain maintenance.
<input type="checkbox"/> Overflow is safely conveyed to a downstream storm drain system or discharge point. Size overflow structure to pass 100-year peak flow for on-line infiltration basins and water quality peak flow for off-line basins.	Planning for overflow lessens the risk of property damage due to flooding.

Nutrient Sensitive Media Design

To design biofiltration with partial retention with underdrain for storm water pollutant control only (no flow control required), the following steps should be taken:

Conceptual Design and Sizing Approach for Storm Water Pollutant Control Only

To design biofiltration with partial retention and an underdrain for storm water pollutant control only (no flow control required), the following steps should be taken:

- 1) Verify that siting and design criteria have been met, including placement requirements, contributing tributary area, maximum side and finish grade slopes, and the recommended media surface area tributary ratio.
- 2) Calculate the DCV per Appendix B based on expected site design runoff for tributary areas.
- 3) Generalized sizing procedure is presented in Appendix B.5. The surface ponding should be verified to have a maximum 24-hour drawdown time.

Conceptual Design and Sizing Approach when Storm Water Flow Control is Applicable

If control of flow rates and/or durations is desired on an Authority project, significant surface ponding and/or aggregate storage volumes will typically be required, and therefore the following steps should be taken prior to determination of storm water pollutant control design. Pre-development and post-project flow rates and durations should be determined as discussed in Chapter 6 of the Copermittees' original Model BMP Design Manual. (As previously indicated in this Manual, development within Authority jurisdiction is not subject to hydromodification management requirements, however this sub-section remains as a reference).

- 1) Verify that siting and design criteria have been met, including placement requirements, contributing tributary area, maximum side and finish grade slopes, and the recommended media surface area tributary ratio.
- 2) Iteratively determine the facility footprint area, surface ponding and/or aggregate storage layer depth required to provide detention and/or infiltration storage to reduce flow rates and durations to allowable limits. Flow rates and durations can be controlled from detention storage by altering outlet structure orifice size(s) and/or water control levels. Multi-level orifices can be used within an outlet structure to control the full range of flows.

- 3) If biofiltration with partial retention cannot fully provide the flow rate and duration control required by this Manual, an upstream or downstream structure with significant storage volume such as an underground vault can be used to provide remaining controls.
- 4) After biofiltration with partial retention has been designed to meet flow control requirements, calculations must be completed to verify if storm water pollutant control requirements to treat the DCV have been met.

Maintenance Overview

Normal Expected Maintenance. Biofiltration with partial retention requires routine maintenance to: remove accumulated materials such as sediment, trash or debris; maintain vegetation health; maintain infiltration capacity of the media layer; replenish mulch; and maintain integrity of side slopes, inlets, energy dissipators, and outlets. A summary table of standard inspection and maintenance indicators is provided within this Fact Sheet.

Non-Standard Maintenance or BMP Failure. If any of the following scenarios are observed, the BMP is not performing as intended to protect downstream waterways from pollution and/or erosion. Corrective maintenance, increased inspection and maintenance, BMP replacement, or a different BMP type will be required.

- The BMP is not drained between storm events. Surface ponding longer than approximately 24 hours following a storm event may be detrimental to vegetation health, and surface ponding longer than approximately 96 hours following a storm event poses a risk of vector (mosquito) breeding. Poor drainage can result from clogging of the media layer, filter course, aggregate storage layer, underdrain, or outlet structure. The specific cause of the drainage issue must be determined and corrected.
- Sediment, trash, or debris accumulation greater than 25 percent of the surface ponding volume within one month. This means the load from the tributary drainage area is too high, reducing BMP function or clogging the BMP. This would require pretreatment measures within the tributary area draining to the BMP to intercept the materials. Pretreatment components, especially for sediment, will extend the life of components that are more expensive to replace such as media, filter course, and aggregate layers.
- Erosion due to concentrated storm water runoff flow that is not readily corrected by adding erosion control blankets, adding stone at flow entry points, or minor re-grading to restore proper drainage according to the original plan. If the issue is not corrected by restoring the BMP to the original plan and grade, the Authority shall be contacted prior to any additional repairs or reconstruction.

Other Special Considerations. Biofiltration with partial retention is a vegetated structural BMP. Vegetated structural BMPs that are constructed in the vicinity of, or connected to, an existing jurisdictional water or wetland could inadvertently result in creation of expanded waters or wetlands. As such, vegetated structural BMPs have the potential to come under the jurisdiction of the United States Army Corps of Engineers, SDRWQCB, California Department of Fish and Wildlife, or the United States Fish and Wildlife Service. This could result in the need for specific resource agency permits and costly mitigation to perform maintenance of the structural BMP. Along with proper placement of a structural BMP, routine maintenance is key to preventing this scenario.

This page intentionally left blank

Summary of Standard Inspection and Maintenance

The property owner is responsible to ensure inspection, operation and maintenance of permanent BMPs on their property unless responsibility has been formally transferred to the Authority.

Maintenance frequencies listed in this table are average/typical frequencies. Actual maintenance needs are site-specific, and maintenance may be required more frequently. Maintenance must be performed whenever needed, based on maintenance indicators presented in this table. The BMP owner is responsible for conducting regular inspections to see when maintenance is needed based on the maintenance indicators. During the first year of operation of a structural BMP, inspection is recommended at least once prior to August 31 and then monthly from September through May. Inspection during a storm event is also recommended. After the initial period of frequent inspections, the minimum inspection and maintenance frequency can be determined based on the results of the first-year inspections.

Threshold/Indicator	Maintenance Action	Typical Maintenance Frequency
Accumulation of sediment, litter, or debris	Remove and properly dispose of accumulated materials, without damage to the vegetation or compaction of the media layer.	<ul style="list-style-type: none"> Inspect monthly. If the BMP is 25% full* or more in one month, increase inspection frequency to monthly plus after every 0.1-inch or larger storm event. Remove any accumulated materials found at each inspection.
Obstructed inlet or outlet structure	Clear blockage.	<ul style="list-style-type: none"> Inspect monthly and after every 0.5-inch or larger storm event. Remove any accumulated materials found at each inspection.
Damage to structural components such as weirs, inlet or outlet structures	Repair or replace as applicable.	<ul style="list-style-type: none"> Inspect annually. Maintain when needed.
Poor vegetation establishment	Re-seed, re-plant, or re-establish vegetation per original plans.	<ul style="list-style-type: none"> Inspect monthly. Maintain when needed.
Dead or diseased vegetation	Remove dead or diseased vegetation, re-seed, re-plant, or re-establish vegetation per original plans.	<ul style="list-style-type: none"> Inspect monthly. Maintain when needed.

Appendix E: BMP Design Fact Sheets

Threshold/Indicator	Maintenance Action	Typical Maintenance Frequency
Overgrown vegetation	Mow or trim as appropriate.	<ul style="list-style-type: none"> ● Inspect monthly. ● Maintain when needed.
2/3 of mulch has decomposed, or mulch has been removed	Remove decomposed fraction and top off with fresh mulch to a total depth of 3 inches.	<ul style="list-style-type: none"> ● Inspect monthly. ● Replenish mulch annually, or more frequently when needed based on inspection.
Erosion due to concentrated irrigation flow	Repair/re-seed/re-plant eroded areas and adjust the irrigation system.	<ul style="list-style-type: none"> ● Inspect monthly. ● Maintain when needed.
Erosion due to concentrated storm water runoff flow	Repair/re-seed/re-plant eroded areas and make appropriate corrective measures such as adding erosion control blankets, adding stone at flow entry points, or minor re-grading to restore proper drainage according to the original plan. If the issue is not corrected by restoring the BMP to the original plan and grade, the Authority shall be contacted prior to any additional repairs or reconstruction.	<ul style="list-style-type: none"> ● Inspect after every 0.5-inch or larger storm event. If erosion due to storm water flow has been observed, increase inspection frequency to after every 0.1-inch or larger storm event. ● Maintain when needed. If the issue is not corrected by restoring the BMP to the original plan and grade, the Authority shall be contacted prior to any additional repairs or reconstruction.
Standing water in BMP for longer than 24 hours following a storm event Surface ponding longer than approximately 24 hours following a storm event may be detrimental to vegetation health	Make appropriate corrective measures such as adjusting irrigation system, removing obstructions of debris or invasive vegetation, clearing underdrains, or repairing/replacing clogged or compacted soils.	<ul style="list-style-type: none"> ● Inspect monthly and after every 0.5-inch or larger storm event. If standing water is observed, increase inspection frequency to after every 0.1-inch or larger storm event. ● Maintain when needed.

Threshold/Indicator	Maintenance Action	Typical Maintenance Frequency
<p>Presence of mosquitos/larvae</p> <p>For images of egg rafts, larva, pupa, and adult mosquitos, see http://www.mosquito.org/biology</p>	<p>If mosquitos/larvae are observed: first, immediately remove any standing water by dispersing to nearby landscaping; second, make corrective measures as applicable to restore BMP drainage to prevent standing water.</p> <p>If mosquitos persist following corrective measures to remove standing water, or if the BMP design does not meet the 96-hour drawdown criteria due to release rates controlled by an orifice installed on the underdrain, the Authority shall be contacted to determine a solution. A different BMP type, or a Vector Management Plan prepared with concurrence from the County of San Diego Department of Environmental Health, may be required.</p>	<ul style="list-style-type: none"> • Inspect monthly and after every 0.5-inch or larger storm event. If mosquitos are observed, increase inspection frequency to after every 0.1-inch or larger storm event. • Maintain when needed.
<p>Underdrain clogged</p>	<p>Clear blockage.</p>	<ul style="list-style-type: none"> • Inspect if standing water is observed for longer than 24-96 hours following a storm event. • Maintain when needed.

This page intentionally left blank

E.15 BF-1 Biofiltration



Location: 43rd Street and Logan Avenue, San Diego, California

Description

Biofiltration (Bioretention with underdrain) facilities are vegetated surface water systems that filter water through vegetation, and soil or engineered media prior to discharge via underdrain or overflow to the downstream conveyance system. Bioretention with underdrain facilities are commonly incorporated into the site within parking lot landscaping, along roadsides, and in open spaces. Because these types of facilities have limited or no infiltration, they are typically designed to provide enough hydraulic head to move flows through the underdrain connection to the storm drain system. Treatment is achieved through filtration, sedimentation, sorption, biochemical processes and plant uptake.

Typical bioretention with underdrain components include:

- Inflow distribution mechanisms (e.g., perimeter flow spreader or filter strips)
- Energy dissipation mechanism for concentrated inflows (e.g., splash blocks or riprap)
- Shallow surface ponding for captured flows
- Side slope and basin bottom vegetation selected based on expected climate and ponding depth
- Non-floating mulch layer (Optional)
- Media layer (planting mix or engineered media) capable of supporting vegetation growth
- Filter course layer consisting of aggregate to prevent the migration of fines into uncompacted native soils or the aggregate storage layer
- Aggregate storage layer with underdrain(s)
- Impermeable liner or uncompacted native soils at the bottom of the facility
- Overflow structure

MS4 Permit Category

Biofiltration

Manual Category

Biofiltration

Applicable Performance Standard

Pollutant Control

Flow Control

Primary Benefits

Treatment

Volume Reduction (Incidental)

Peak Flow Attenuation (Optional)

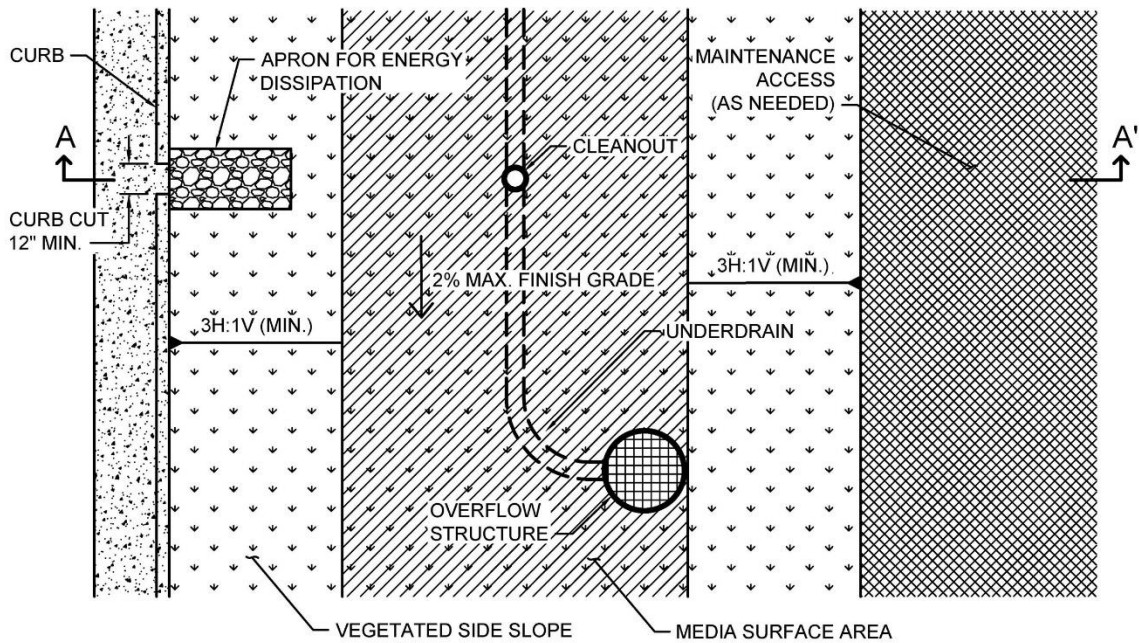

PLAN
NOT TO SCALE

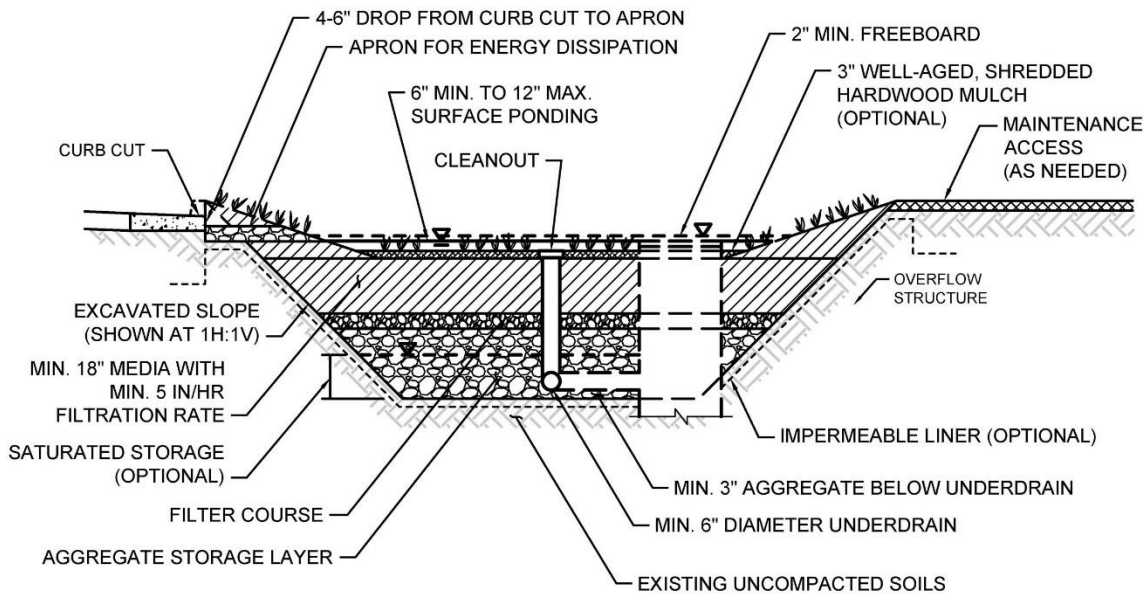

SECTION A-A'
NOT TO SCALE

Typical Plan and Section View of a Biofiltration BMP

Design Adaptations for Project Goals

Biofiltration Treatment BMP for storm water pollutant control. The system is lined or un-lined to provide incidental infiltration, and an underdrain is provided at the bottom to carry away filtered runoff. This configuration is considered to provide biofiltration treatment via flow through the media layer. Storage provided above the underdrain within surface ponding, media, and aggregate storage is considered included in the biofiltration treatment volume. Saturated storage within the aggregate storage layer can be added to this design by raising the underdrain above the bottom of the aggregate storage layer or via an internal weir structure designed to maintain a specific water level elevation.

Integrated storm water flow control and pollutant control configuration. The system can be designed to provide flow rate and duration control by primarily providing increased surface ponding and/or having a deeper aggregate storage layer above the underdrain. This will allow for significant detention storage, which can be controlled via inclusion of an outlet structure at the downstream end of the underdrain.

Recommended Siting Criteria

<i>Siting Criteria</i>	<i>Intent/Rationale</i>
<input type="checkbox"/> Placement observes geotechnical recommendations regarding potential hazards (e.g., slope stability, landslides, liquefaction zones) and setbacks (e.g., slopes, foundations, utilities).	Must not negatively impact existing site geotechnical concerns.
<input type="checkbox"/> An impermeable liner or other hydraulic restriction layer is included if site constraints indicate that infiltration or lateral flows should not be allowed.	Lining prevents storm water from impacting groundwater and/or sensitive environmental or geotechnical features. Incidental infiltration, when allowable, can aid in pollutant removal and groundwater recharge.
<input type="checkbox"/> Contributing tributary area shall be ≤ 5 acres (≤ 1 acre preferred).	Bigger BMPs require additional design features for proper performance. Contributing tributary area greater than 5 acres may be allowed at the discretion of the Authority if the following conditions are met: 1) incorporate design features (e.g., flow spreaders) to minimizing short circuiting of flows in the BMP and 2) incorporate additional design features requested by the Authority for proper performance of the regional BMP.
<input type="checkbox"/> Finish grade of the facility is $\leq 2\%$.	Flatter surfaces reduce erosion and channelization within the facility.

Recommended BMP Component Dimensions

<i>BMP Component</i>	<i>Dimension</i>	<i>Intent/Rationale</i>
Freeboard	≥ 2 inches	Freeboard provides room for head over overflow structures and minimizes risk of uncontrolled surface discharge.
Surface Ponding	≥ 6 and ≤ 12 inches	Surface ponding capacity lowers subsurface storage requirements. Deep surface ponding raises safety concerns. Surface ponding depth greater than 12 inches (for additional pollutant control or surface outlet structures or flow-control orifices) may be allowed at the discretion of the Authority if the following conditions are met: 1) surface ponding depth drawdown time is less than 24 hours; and 2) safety issues and fencing requirements are considered (typically ponding greater than 18” will require a fence and/or flatter side slopes) and 3) potential for elevated clogging risk is considered.
Ponding Area Side Slopes	3H:1V or shallower	Gentler side slopes are safer, less prone to erosion, able to establish vegetation more quickly and easier to maintain.
Mulch	≥ 3 inches	Mulch will suppress weeds and maintain moisture for plant growth. Aging mulch kills pathogens and weed seeds and allows the beneficial microbes to multiply.
Media Layer	≥ 18 inches	A deep media layer provides additional filtration and supports plants with deeper roots. Standard specifications shall be followed. For non-standard or proprietary designs, compliance with F.1 ensures that adequate treatment performance will be provided.
Underdrain Diameter	≥ 6 inches	Smaller diameter underdrains are prone to clogging.
Cleanout Diameter	≥ 6 inches	Properly spaced cleanouts will facilitate underdrain maintenance.

Design Criteria and Considerations

Bioretention with underdrain must meet the following design criteria. Deviations from the below criteria may be approved at the discretion of the Authority if it is determined to be appropriate:

<i>Design Criteria</i>	<i>Intent/Rationale</i>
Surface Ponding	
<input type="checkbox"/> Surface ponding is limited to a 24-hour drawdown time.	Surface ponding limited to 24 hours for plant health. Surface ponding drawdown time greater than 24-hours but less than 96 hours may be allowed at the discretion of the P&EAD if certified by a landscape architect or agronomist.
Vegetation	
<input type="checkbox"/> Plantings are suitable for the climate and expected ponding depth. A plant list to aid in selection can be found in Appendix E.23.	Plants suited to the climate and ponding depth are more likely to survive.
<input type="checkbox"/> An irrigation system with a connection to water supply should be provided as needed.	Seasonal irrigation might be needed to keep plants healthy.
Mulch (Optional)	
<input type="checkbox"/> A minimum of 3 inches of well-aged, shredded hardwood mulch that has been stockpiled or stored for at least 12 months is provided.	Mulch will suppress weeds and maintain moisture for plant growth. Aging mulch kills pathogens and weed seeds and allows the beneficial microbes to multiply.
Media Layer	
<input type="checkbox"/> Media maintains a minimum filtration rate of 5 inches/hour over lifetime of facility. An initial filtration rate of 8 to 12 inches/hour is recommended to allow for clogging over time; the initial filtration rate should not exceed 12 inches per hour.	A filtration rate of at least 5 inches per hour allows soil to drain between events. The initial rate should be higher than long term target rate to account for clogging over time. However, an excessively high initial rate can have a negative impact on treatment performance, therefore an upper limit is needed.

<i>Design Criteria</i>	<i>Intent/Rationale</i>
<p><input type="checkbox"/> Media is a minimum 18 inches deep, meeting either of these two media specifications: City of San Diego Storm Water Standards Appendix F (February 2016, unless superseded by more recent edition) or County of San Diego Low Impact Development Handbook: Appendix G -Bioretention Soil Specification (June 2014, unless superseded by more recent edition). Alternatively, for proprietary designs and custom media mixes not meeting the media specifications contained in the 2016 City Storm Water Standards or County LID Manual, the media meets the pollutant treatment performance criteria in Section F.1.</p>	<p>A deep media layer provides additional filtration and supports plants with deeper roots.</p> <p>Standard specifications shall be followed.</p> <p>For non-standard or proprietary designs, compliance with F.1 ensures that adequate treatment performance will be provided.</p>
<p><input type="checkbox"/> Media surface area is 3% of contributing area times adjusted runoff factor or greater. Unless demonstrated that the BMP surface area can be smaller than 3%.</p>	<p>Greater surface area to tributary area ratios: a) maximizes volume retention as required by the MS4 Permit and b) decrease loading rates per ft² and therefore increase longevity. Adjusted runoff factor is to account for site design BMPs implemented upstream of the BMP (such as rain barrels, impervious area dispersion, etc.). Refer to Appendix B.2 guidance. Use Worksheet B.5-1 Line 26 to estimate the minimum surface area required per these criteria.</p>
<p><input type="checkbox"/> Where receiving waters are impaired or have a TMDL for nutrients, the system is designed with nutrient sensitive media design (see fact sheet BF-2).</p>	<p>Potential for pollutant export is partly a function of media composition; media design must minimize potential for export of nutrients, particularly where receiving waters are impaired for nutrients.</p>
<i>Filter Course Layer</i>	
<p><input type="checkbox"/> A filter course is used to prevent migration of fines through layers of the facility. Filter fabric is not used.</p>	<p>Migration of media can cause clogging of the aggregate storage layer void spaces or subgrade. Filter fabric is more likely to clog.</p>
<p><input type="checkbox"/> Filter course is washed and free of fines.</p>	<p>Washing aggregate will help eliminate fines that could clog the facility and impede infiltration.</p>

<i>Design Criteria</i>	<i>Intent/Rationale</i>
<input type="checkbox"/> Filter course calculations assessing suitability for particle migration prevention have been completed.	Gradation relationship between layers can evaluate factors (e.g., bridging, permeability, and uniformity) to determine if particle sizing is appropriate or if an intermediate layer is needed.
Aggregate Storage Layer	
<input type="checkbox"/> Class 2 Permeable per Caltrans specification 68-1.025 is recommended for the storage layer. Washed, open-graded crushed rock may be used, however a 4-6 inch washed pea gravel filter course layer at the top of the crushed rock is required.	Washing aggregate will help eliminate fines that could clog the aggregate storage layer void spaces or subgrade.
<input type="checkbox"/> The depth of aggregate provided (12-inch typical) and storage layer configuration is adequate for providing conveyance for underdrain flows to the outlet structure.	Proper storage layer configuration and underdrain placement will minimize facility drawdown time.
Inflow, Underdrain, and Outflow Structures	
<input type="checkbox"/> Inflow, underdrains and outflow structures are accessible for inspection and maintenance.	Maintenance will prevent clogging and ensure proper operation of the flow control structures.
<input type="checkbox"/> Inflow velocities are limited to 3 ft/s or less or use energy dissipation methods. (e.g., riprap, level spreader) for concentrated inflows.	High inflow velocities can cause erosion, scour and/or channeling.
<input type="checkbox"/> Curb cut inlets are at least 12 inches wide, have a 4-6 inch reveal (drop) and an apron and energy dissipation as needed.	Inlets must not restrict flow and apron prevents blockage from vegetation as it grows in. Energy dissipation prevents erosion.
<input type="checkbox"/> Underdrain outlet elevation should be a minimum of 3 inches above the bottom elevation of the aggregate storage layer.	A minimal separation from subgrade or the liner lessens the risk of fines entering the underdrain and can improve hydraulic performance by allowing perforations to remain unblocked.
<input type="checkbox"/> Minimum underdrain diameter is 6 inches.	Smaller diameter underdrains are prone to clogging.
<input type="checkbox"/> Underdrains are made of slotted, PVC pipe conforming to ASTM D 3034 or equivalent or corrugated, HDPE pipe conforming to AASHTO 252M or equivalent.	Slotted underdrains provide greater intake capacity, clog resistant drainage, and reduced entrance velocity into the pipe, thereby reducing the chances of solids migration.
<input type="checkbox"/> An underdrain cleanout with a minimum 6-inch diameter and lockable cap is placed every 250 to 300 feet as required based on underdrain length.	Properly spaced cleanouts will facilitate underdrain maintenance.

<i>Design Criteria</i>	<i>Intent/Rationale</i>
<input type="checkbox"/> Overflow is safely conveyed to a downstream storm drain system or discharge point. Size overflow structure to pass 100-year peak flow for on-line infiltration basins and water quality peak flow for off-line basins.	Planning for overflow lessens the risk of property damage due to flooding.

Conceptual Design and Sizing Approach for Storm Water Pollutant Control Only

To design bioretention with underdrain for storm water pollutant control only (no flow control required), the following steps should be taken:

- 1) Verify that siting and design criteria have been met, including placement requirements, contributing tributary area, maximum side and finish grade slopes, and the recommended media surface area tributary ratio.
- 2) Calculate the DCV per Appendix B based on expected site design runoff for tributary areas.
- 3) Use the sizing worksheet presented in Appendix B.5 to size biofiltration BMPs.

Conceptual Design and Sizing Approach when Storm Water Flow Control is Applicable

If control of flow rates and/or durations is desired on an Authority project, significant surface ponding and/or aggregate storage volumes will typically be required, and therefore the following steps should be taken prior to determination of storm water pollutant control design. Pre-development and post-project flow rates and durations should be determined as discussed in Chapter 6 of the Copermittes' original Model BMP Design Manual. (As previously indicated in this Manual, development within Authority jurisdiction is not subject to hydromodification management requirements, however this sub-section remains as a reference).

- 1) Verify that siting and design criteria have been met, including placement requirements, contributing tributary area, maximum side and finish grade slopes, and the recommended media surface area tributary ratio.
- 2) Iteratively determine the facility footprint area, surface ponding and/or aggregate storage layer depth required to provide detention storage to reduce flow rates and durations to allowable limits. Flow rates and durations can be controlled from detention storage by altering outlet structure orifice size(s) and/or water control levels. Multi-level orifices can be used within an outlet structure to control the full range of flows.
- 3) If bioretention with underdrain cannot fully provide the flow rate and duration control required by this Manual, an upstream or downstream structure with significant storage volume such as an underground vault can be used to provide remaining controls.
- 4) After bioretention with underdrain has been designed to meet flow control requirements, calculations must be completed to verify if storm water pollutant control requirements to treat the DCV have been met.

Maintenance Overview

Normal Expected Maintenance. Biofiltration requires routine maintenance to: remove accumulated materials such as sediment, trash or debris; maintain vegetation health; maintain infiltration capacity of the media layer; replenish mulch; and maintain integrity of side slopes, inlets, energy dissipators, and outlets. A summary table of standard inspection and maintenance indicators is provided within this Fact Sheet.

Non-Standard Maintenance or BMP Failure. If any of the following scenarios are observed, the BMP is not performing as intended to protect downstream waterways from pollution and/or erosion. Corrective maintenance, increased inspection and maintenance, BMP replacement, or a different BMP type will be required.

- The BMP is not drained between storm events. Surface ponding longer than approximately 24 hours following a storm event may be detrimental to vegetation health, and surface ponding longer than approximately 96 hours following a storm event poses a risk of vector (mosquito) breeding. Poor drainage can result from clogging of the media layer, filter course, aggregate storage layer, underdrain, or outlet structure. The specific cause of the drainage issue must be determined and corrected.
- Sediment, trash, or debris accumulation greater than 25 percent of the surface ponding volume within one month. This means the load from the tributary drainage area is too high, reducing BMP function or clogging the BMP. This would require pretreatment measures within the tributary area draining to the BMP to intercept the materials. Pretreatment components, especially for sediment, will extend the life of components that are more expensive to replace such as media, filter course, and aggregate layers.
- Erosion due to concentrated storm water runoff flow that is not readily corrected by adding erosion control blankets, adding stone at flow entry points, or minor re-grading to restore proper drainage according to the original plan. If the issue is not corrected by restoring the BMP to the original plan and grade, the Authority shall be contacted prior to any additional repairs or reconstruction.

Other Special Considerations. Biofiltration is a vegetated structural BMP. Vegetated structural BMPs that are constructed in the vicinity of, or connected to, an existing jurisdictional water or wetland could inadvertently result in creation of expanded waters or wetlands. As such, vegetated structural BMPs have the potential to come under the jurisdiction of the United States Army Corps of Engineers, SDRWQCB, California Department of Fish and Wildlife, or the United States Fish and Wildlife Service. This could result in the need for specific resource agency permits and costly mitigation to perform maintenance of the structural BMP. Along with proper placement of a structural BMP, routine maintenance is key to preventing this scenario.

This page intentionally left blank

Summary of Standard Inspection and Maintenance

The property owner is responsible to ensure inspection, operation and maintenance of permanent BMPs on their property unless responsibility has been formally transferred to the Authority.

Maintenance frequencies listed in this table are average/typical frequencies. Actual maintenance needs are site-specific, and maintenance may be required more frequently. Maintenance must be performed whenever needed, based on maintenance indicators presented in this table. The BMP owner is responsible for conducting regular inspections to see when maintenance is needed based on the maintenance indicators. During the first year of operation of a structural BMP, inspection is recommended at least once prior to August 31 and then monthly from September through May. Inspection during a storm event is also recommended. After the initial period of frequent inspections, the minimum inspection and maintenance frequency can be determined based on the results of the first-year inspections.

Threshold/Indicator	Maintenance Action	Typical Maintenance Frequency
Accumulation of sediment, litter, or debris	Remove and properly dispose of accumulated materials, without damage to the vegetation or compaction of the media layer.	<ul style="list-style-type: none"> Inspect monthly. If the BMP is 25% full* or more in one month, increase inspection frequency to monthly plus after every 0.1-inch or larger storm event. Remove any accumulated materials found at each inspection.
Obstructed inlet or outlet structure	Clear blockage.	<ul style="list-style-type: none"> Inspect monthly and after every 0.5-inch or larger storm event. Remove any accumulated materials found at each inspection.
Damage to structural components such as weirs, inlet or outlet structures	Repair or replace as applicable	<ul style="list-style-type: none"> Inspect annually. Maintain when needed.
Poor vegetation establishment	Re-seed, re-plant, or re-establish vegetation per original plans.	<ul style="list-style-type: none"> Inspect monthly. Maintain when needed.
Dead or diseased vegetation	Remove dead or diseased vegetation, re-seed, re-plant, or re-establish vegetation per original plans.	<ul style="list-style-type: none"> Inspect monthly. Maintain when needed.

Appendix E: BMP Design Fact Sheets

Threshold/Indicator	Maintenance Action	Typical Maintenance Frequency
Overgrown vegetation	Mow or trim as appropriate.	<ul style="list-style-type: none"> ● Inspect monthly. ● Maintain when needed.
2/3 of mulch has decomposed, or mulch has been removed	Remove decomposed fraction and top off with fresh mulch to a total depth of 3 inches.	<ul style="list-style-type: none"> ● Inspect monthly. ● Replenish mulch annually, or more frequently when needed based on inspection.
Erosion due to concentrated irrigation flow	Repair/re-seed/re-plant eroded areas and adjust the irrigation system.	<ul style="list-style-type: none"> ● Inspect monthly. ● Maintain when needed.
Erosion due to concentrated storm water runoff flow	Repair/re-seed/re-plant eroded areas and make appropriate corrective measures such as adding erosion control blankets, adding stone at flow entry points, or minor re-grading to restore proper drainage according to the original plan. If the issue is not corrected by restoring the BMP to the original plan and grade, the Authority shall be contacted prior to any additional repairs or reconstruction.	<ul style="list-style-type: none"> ● Inspect after every 0.5-inch or larger storm event. If erosion due to storm water flow has been observed, increase inspection frequency to after every 0.1-inch or larger storm event. ● Maintain when needed. If the issue is not corrected by restoring the BMP to the original plan and grade, the Authority shall be contacted prior to any additional repairs or reconstruction.
Standing water in BMP for longer than 24 hours following a storm event Surface ponding longer than approximately 24 hours following a storm event may be detrimental to vegetation health	Make appropriate corrective measures such as adjusting irrigation system, removing obstructions of debris or invasive vegetation, clearing underdrains, or repairing/replacing clogged or compacted soils.	<ul style="list-style-type: none"> ● Inspect monthly and after every 0.5-inch or larger storm event. If standing water is observed, increase inspection frequency to after every 0.1-inch or larger storm event. ● Maintain when needed.

Appendix E: BMP Design Fact Sheets

Threshold/Indicator	Maintenance Action	Typical Maintenance Frequency
<p>Presence of mosquitos/larvae</p> <p>For images of egg rafts, larva, pupa, and adult mosquitos, see http://www.mosquito.org/biology</p>	<p>If mosquitos/larvae are observed: first, immediately remove any standing water by dispersing to nearby landscaping; second, make corrective measures as applicable to restore BMP drainage to prevent standing water.</p> <p>If mosquitos persist following corrective measures to remove standing water, or if the BMP design does not meet the 96-hour drawdown criteria due to release rates controlled by an orifice installed on the underdrain, the Authority shall be contacted to determine a solution. A different BMP type, or a Vector Management Plan prepared with concurrence from the County of San Diego Department of Environmental Health, may be required.</p>	<ul style="list-style-type: none"> • Inspect monthly and after every 0.5-inch or larger storm event. If mosquitos are observed, increase inspection frequency to after every 0.1-inch or larger storm event. • Maintain when needed.
<p>Underdrain clogged</p>	<p>Clear blockage.</p>	<ul style="list-style-type: none"> • Inspect if standing water is observed for longer than 24-96 hours following a storm event. • Maintain when needed.

“25% full” is defined as ¼ of the depth from the design bottom elevation to the crest of the outflow structure (e.g., if the height to the outflow opening is 12 inches from the bottom elevation, then the materials must be removed when there is 3 inches of accumulation – this should be marked on the outflow structure).

This page intentionally left blank

E.16 BF-2 Nutrient Sensitive Media Design

Some studies of bioretention with underdrains have observed export of nutrients, particularly inorganic nitrogen (nitrate and nitrite) and dissolved phosphorus. This has been observed to be a short-lived phenomenon in some studies or a long-term issue in some studies. The composition of the soil media, including the chemistry of individual elements is believed to be an important factor in the potential for nutrient export. Organic amendments, often compost, have been identified as the most likely source of nutrient export. The quality and stability of organic amendments can vary widely.

The biofiltration media specifications contained in the County of San Diego Low Impact Development Handbook: Appendix G -Bioretention Soil Specification (June 2014, unless superseded by more recent edition) and the City of San Diego Low Impact Development Design Manual (page B-18) (July 2011, unless superseded by more recent edition) were developed with consideration of the potential for nutrient export. These specifications include criteria for individual component characteristics and quality in order to control the overall quality of the blended mixes. As of the publication of this Manual, the June 2014 County of San Diego specifications provide more detail regarding mix design and quality control.

The City and County specifications noted above were developed for general purposes to meet permeability and treatment goals. In cases where the BMP discharges to receiving waters with nutrient impairments or nutrient TMDLs, the biofiltration media should be designed with the specific goal of minimizing the potential for export of nutrients from the media. Therefore, in addition to adhering to the City or County media specifications, the following guidelines should be followed:

1. Select plant palette to minimize plant nutrient needs

A landscape architect or agronomist should be consulted to select a plant palette that minimizes nutrient needs. Utilizing plants with low nutrient needs results in less need to enrich the biofiltration soil mix. If nutrient quantity is then tailored to plants with lower nutrient needs, these plants will generally have less competition from weeds, which typically need higher nutrient content. The following practices are recommended to minimize nutrient needs of the plant palette:

- **Utilize native, drought-tolerant plants and grasses where possible.** Native plants generally have a broader tolerance for nutrient content and can be longer lived in leaner/lower nutrient soils.
- **Start plants from smaller starts or seed.** Younger plants are generally more tolerant of lower nutrient levels and tend to help develop soil structure as they grow. Given the lower cost of smaller plants, the project should be able to accept a plant mortality rate that is somewhat higher than starting from larger plants and providing high organic content.

2. Minimize excess nutrients in media mix

Once the low-nutrient plant palette is established (item 1), the landscape architect and/or agronomist should be consulted to assist in the design of a biofiltration media to balance the interests of plant establishment, water retention capacity (irrigation demand), and the potential for nutrient export. The following guidelines should be followed:

- **The mix should not exceed the nutrient needs of plants.** In conventional landscape design, the nutrient needs of plants are often exceeded intentionally in order to provide a factor of safety for plant survival. This practice must be avoided in biofiltration media as excess nutrients will increase the chance of export. The mix designer should keep in mind that nutrients can be added later (through mulching, tilling of amendments into the surface), but it is not possible to remove nutrients, once added.
- **The actual nutrient content and organic content of the selected organic amendment source should be determined when specifying mix proportions.** Nutrient content (i.e., C:N ratio; plant extractable nutrients) and organic content (i.e., percent organic material) are relatively inexpensive to measure via standard agronomic methods and can provide important information about mix design. If mix design relies on approximate assumption about nutrient/organic content and this is not confirmed with testing (or the results of prior representative testing), it is possible that the mix could contain much more nutrient than intended.
- **Nutrients are better retained in soils with higher cation exchange capacity.** Cation exchange capacity can be increased through selection of organic material with naturally high cation exchange capacity, such as peat or coconut coir pith, and/or selection of inorganic material with high cation exchange capacity such as some sands or engineered minerals (e.g., low P-index sands, zeolites, rhyolites, etc.). Including higher cation exchange capacity materials would tend to reduce the net export of nutrients. Natural silty materials also provide cation exchange capacity; however potential impacts to permeability need to be considered.
- **Focus on soil structure as well as nutrient content.** Soil structure is loosely defined as the ability of the soil to conduct and store water and nutrients as well as the degree of aeration of the soil. Soil structure can be more important than nutrient content in plant survival and biologic health of the system. If a good soil structure can be created with very low amounts of organic amendment, plants survivability should still be provided. Although soil structure generally develops with time, biofiltration media can be designed to promote earlier development of soil structure. Soil structure is enhanced by the use of amendments with high humus content (as found in well-aged organic material). In addition, soil structure can be enhanced through the use of organic material with a distribution of particle sizes (i.e., a more heterogeneous mix).
- **Consider alternatives to compost.** Compost, by nature, is a material that is continually evolving and decaying. It can be challenging to determine whether tests previously done on a given compost stock are still representative. It can also be challenging to determine how the properties of the compost will change once placed in the media bed. More stable materials such as aged coco coir pith, peat, biochar, shredded bark, and/or other amendments should be considered.

With these considerations, it is anticipated that less than 10 percent organic amendment by volume could be used, while still balancing plant survivability and water retention. If compost is used, designers should strongly consider utilizing less than 10 percent by volume.

3. Design with partial retention and/or internal water storage

Appendix E: BMP Design Fact Sheets

An internal water storage zone, as described in Fact Sheet PR-1 is believed to improve retention of nutrients. For lined systems, an internal water storage zone worked by providing a zone that fluctuates between aerobic and anaerobic conditions, resulting in nitrification/denitrification. In soils that will allow infiltration, a partial retention design (PR-1) allows significant volume reduction and can also promote nitrification/denitrification.

Acknowledgment: This fact sheet has been adapted from the Orange County Technical Guidance Document (May 2011). It was originally developed based on input from: Deborah Deets, City of Los Angeles Bureau of Sanitation, Drew Ready, Center for Watershed Health, Rick Fisher, ASLA, City of Los Angeles Bureau of Engineering, Dr. Garn Wallace, Wallace Laboratories, Glen Dake, GDML, and Jason Schmidt, Tree People. The guidance provided herein does not reflect the individual opinions of any individual listed above and should not be cited or otherwise attributed to those listed.

Maintenance Overview

Refer to maintenance information provided in the Biofiltration (BF-1) Fact Sheet. Adjust maintenance actions and reporting if required based on the specific media design.

E.17 BF-3 Proprietary Biofiltration Systems

The purpose of this fact sheet is to help explain the potential role of proprietary BMPs in meeting biofiltration requirements, when full retention of the DCV is not feasible. The fact sheet does not describe design criteria like the other fact sheets in this appendix because this information varies by BMP product model.

Criteria for Use of a Proprietary BMP as a Biofiltration BMP

A proprietary BMP may be acceptable as a “biofiltration BMP” under the following conditions:

- 1) The BMP meets the minimum design criteria listed in Appendix F, including the pollutant treatment performance standard in Appendix F.1;
- 2) The BMP is designed and maintained in a manner consistent with its performance certifications (See explanation in Appendix F.2); and
- 3) The BMP is acceptable at the discretion of the Authority. In determining the acceptability of a BMP, the Authority should consider, as applicable, (a) the data submitted; (b) representativeness of the data submitted; (c) consistency of the BMP performance claims with pollutant control objectives; certainty of the BMP performance claims; (d) for projects within the public right of way and/or capital projects: maintenance requirements, cost of maintenance activities, relevant previous local experience with operation and maintenance of the BMP type, ability to continue to operate the system in event that the vending company is no longer operating as a business; and (e) other relevant factors. If a proposed BMP is not accepted by the Authority, a written explanation/reason will be provided to the applicant.

Guidance for Sizing a Proprietary BMP as a Biofiltration BMP

Proprietary biofiltration BMPs must meet the same sizing guidance as non-proprietary BMPs. Sizing is typically based on capturing and treating 1.50 times the DCV not reliably retained. Guidance for sizing biofiltration BMPs to comply with requirements of this Manual is provided in Appendix F.2.

Jurisdiction-specific Guidance and Criteria

Maintenance Overview

Refer to manufacturer for maintenance information.

E.18 FT-1 Vegetated Swales



Location: Eastlake Business Center, Chula Vista, California; Photo Credit: Eric Mosolgo

MS4 Permit Category

Flow-through Treatment Control

Manual Category

Flow-through Treatment Control

Applicable Performance Standard

Pollutant Control

Primary Benefits

Treatment
Volume Reduction (Incidental)
Peak Flow Attenuation

Description

Vegetated swales are shallow, open channels that are designed to remove storm water pollutants by physically straining/filtering runoff through vegetation in the channel. Swales can be used in place of traditional curbs and gutters and are well-suited for use in linear transportation corridors to provide both conveyance and treatment via filtration. An effectively designed vegetated swale achieves uniform sheet flow through densely vegetated areas. When soil conditions allow, infiltration and volume reduction are enhanced by adding a gravel drainage layer underneath the swale. Vegetated swales with a subsurface media layer can provide enhanced infiltration, water retention, and pollutant-removal capabilities. Pollutant removal effectiveness can also be maximized by increasing the hydraulic residence time of water in swale using weirs or check dams.

Typical vegetated swale components include:

- Inflow distribution mechanisms (e.g., flow spreader)
- Surface flow
- Vegetated surface layer
- Check dams (if required)
- Optional aggregate storage layer with underdrain(s)

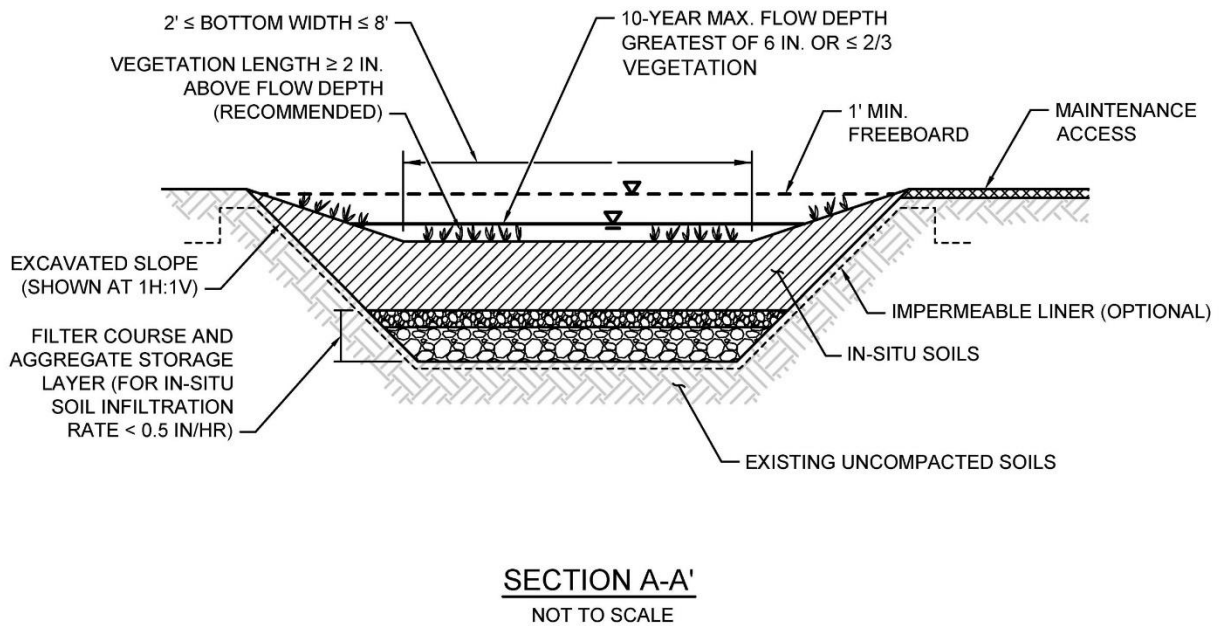
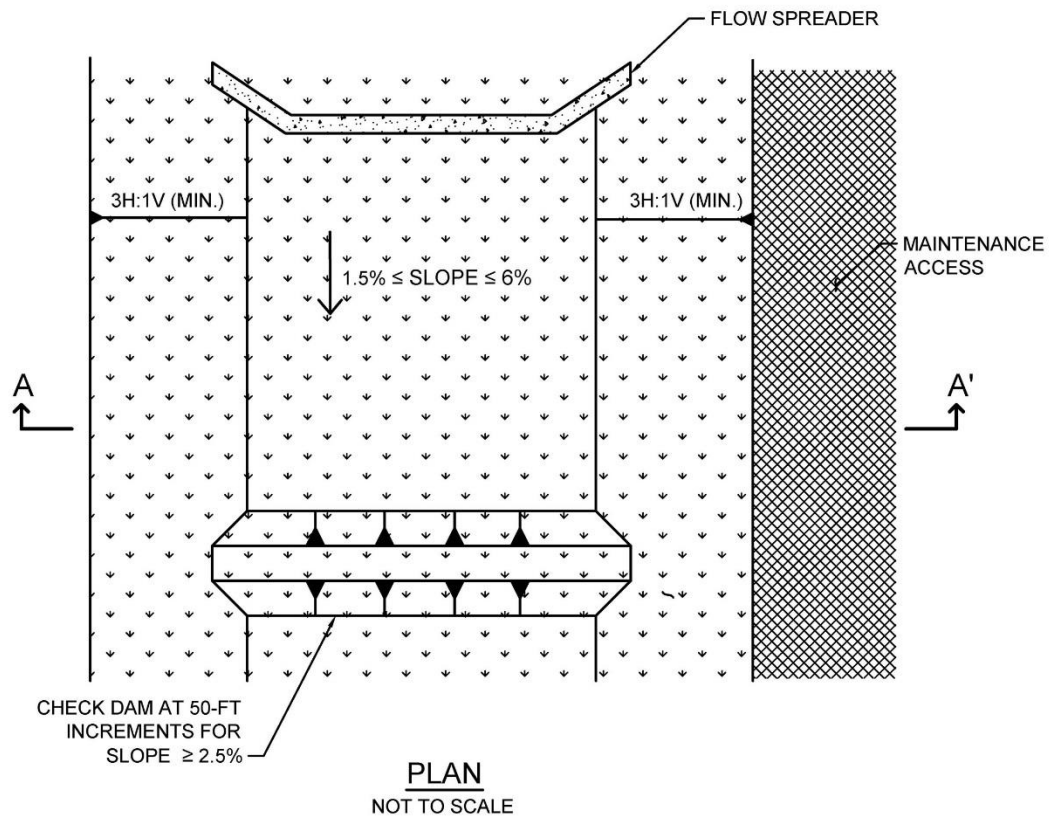

Typical Plan and Section View of a Vegetated Swale BMP

Design Adaptations for Project Goals

Site design BMP to reduce runoff volumes and storm peaks. Swales without underdrains are an alternative to lined channels and pipes and can provide volume reduction through infiltration. Swales can also reduce the peak runoff discharge rate by increasing the time of concentration of the site and decreasing runoff volumes and velocities.

Flow-through treatment BMP for storm water pollutant control. The system is lined or un-lined to provide incidental infiltration with an underdrain and designed to provide pollutant removal through settling and filtration in the channel vegetation (usually grasses). This configuration is considered to provide flow-through treatment via horizontal surface flow through the swale. Sizing for flow-through treatment control is based on the surface flow rate through the swale that meets water quality treatment performance objectives.

Design Criteria and Considerations

Vegetated swales must meet the following design criteria. Deviations from the below criteria may be approved at the discretion of the Authority if it is determined to be appropriate:

<i>Siting and Design</i>	<i>Intent/Rationale</i>
<input type="checkbox"/> Placement observes geotechnical recommendations regarding potential hazards (e.g., slope stability, landslides, and liquefaction zones) and setbacks (e.g., slopes, foundations, utilities).	Must not negatively impact existing site geotechnical concerns.
<input type="checkbox"/> An impermeable liner or other hydraulic restriction layer is included if site constraints indicate that infiltration or lateral flows should not be allowed.	Lining prevents storm water from impacting groundwater and/or sensitive environmental or geotechnical features. Incidental infiltration, when allowable, can aid in pollutant removal and groundwater recharge.
<input type="checkbox"/> Contributing tributary area ≤ 2 acres.	Higher ratios increase the potential for clogging but may be acceptable for relatively clean tributary areas.
<input type="checkbox"/> Longitudinal slope is $\geq 1.5\%$ and $\leq 6\%$.	Flatter swales facilitate increased water quality treatment while minimum slopes prevent ponding.
<input type="checkbox"/> For site design goal, in-situ soil infiltration rate ≥ 0.5 inch/hour (if < 0.5 inch/hour, an underdrain is required, and design goal is for pollutant control only).	Well-drained soils provide volume reduction and treatment. An underdrain should only be provided when soil infiltration rates are low or per geotechnical or groundwater concerns.
Surface Flow	
<input type="checkbox"/> Maximum flow depth is ≤ 6 inches or $\leq 2/3$ the vegetation length, whichever is greater. Ideally, flow depth will be ≥ 2 inches below shortest plant species.	Flow depth must fall within the height range of the vegetation for effective water quality treatment via filtering.

<i>Siting and Design</i>	<i>Intent/Rationale</i>
A minimum of 1 foot of freeboard is provided.	Freeboard minimizes risk of uncontrolled surface discharge.
<input type="checkbox"/> Cross sectional shape is trapezoidal or parabolic with side slopes $\geq 3H:1V$.	Gentler side slopes are safer, less prone to erosion, able to establish vegetation more quickly and easier to maintain.
<input type="checkbox"/> Bottom width is ≥ 2 feet and ≤ 8 feet.	A minimum of 2 feet minimizes erosion. A maximum of 8 feet prevents channel braiding.
<input type="checkbox"/> Minimum hydraulic residence time ≥ 10 minutes.	Longer hydraulic residence time increases pollutant removal.
<input type="checkbox"/> Swale is designed to safely convey the 10-yr storm event unless a flow splitter is included to allow only the water quality event.	Planning for larger storm events lessens the risk of property damage due to flooding.
<input type="checkbox"/> Flow velocity is ≤ 1 ft/s for water quality event. Flow velocity for 10-yr storm event is ≤ 3 ft/s.	Lower flow velocities provide increased pollutant removal via filtration and minimize erosion.
<i>Vegetated Surface Layer (amendment with media is Optional)</i>	
<input type="checkbox"/> Soil is amended with 2 inches of media mixed into the top 6 inches of in-situ soils, as needed, to promote plant growth (optional). For enhanced pollutant control, 2 feet of media can be used in place of in-situ soils. Media meets either of these two media specifications: City of San Diego Storm Water Standards Appendix F, February 2016); Or County of San Diego Low Impact Development Handbook, June 2014: Appendix G -Bioretention Soil Specification.	Amended soils aid in plant establishment and growth. Media replacement for in-situ soils can improve water quality treatment and site design volume reduction.
<input type="checkbox"/> Vegetation is appropriately selected low-growing, erosion-resistant plant species that effectively bind the soil, thrive under site-specific climatic conditions and require little or no irrigation.	Plants suited to the climate and expected flow conditions are more likely to survive.
<i>Check Dams</i>	
<input type="checkbox"/> Check dams are provided at 50-foot increments for slopes $\geq 2.5\%$.	Check dams prevent erosion and increase the hydraulic residence time by lowering flow velocities and providing ponding opportunities.
<i>Filter Course Layer (For Underdrain Design)</i>	
<input type="checkbox"/> A filter course is used to prevent migration of fines through layers of the facility. Filter fabric is not used.	Migration of media can cause clogging of the aggregate storage layer void spaces or subgrade. Filter fabric is more likely to clog.

<i>Siting and Design</i>		<i>Intent/Rationale</i>
<input type="checkbox"/>	Filter course is washed and free of fines.	Washing aggregate will help eliminate fines that could clog the facility and impede infiltration.
<input type="checkbox"/>	Filter course calculations assessing suitability for particle migration prevention have been completed.	Gradation relationship between layers can evaluate factors (e.g., bridging, permeability, and uniformity) to determine if particle sizing is appropriate or if an intermediate layer is needed.
<i>Aggregate Storage Layer (For Underdrain Design)</i>		
<input type="checkbox"/>	The depth of aggregate provided (12-inch typical) and storage layer configuration is adequate for providing conveyance for underdrain flows to the outlet structure.	Proper storage layer configuration and underdrain placement will minimize facility drawdown time.
<input type="checkbox"/>	Aggregate used for the aggregate storage layer is washed and free of fines.	Washing aggregate will help eliminate fines that could clog aggregate storage layer void spaces or underdrain.
<i>Inflow and Underdrain Structures</i>		
<input type="checkbox"/>	Inflow and underdrains are accessible for inspection and maintenance.	Maintenance will prevent clogging and ensure proper operation of the flow control structures.
<input type="checkbox"/>	Underdrain outlet elevation should be a minimum of 3 inches above the bottom elevation of the aggregate storage layer.	A minimal separation from subgrade or the liner lessens the risk of fines entering the underdrain and can improve hydraulic performance by allowing perforations to remain unblocked.
<input type="checkbox"/>	Minimum underdrain diameter is 6 inches.	Smaller diameter underdrains are prone to clogging.
<input type="checkbox"/>	Underdrains are made of slotted, PVC pipe conforming to ASTM D 3034 or equivalent or corrugated, HDPE pipe conforming to AASHTO 252M or equivalent.	Slotted underdrains provide greater intake capacity, clog resistant drainage, and reduced entrance velocity into the pipe, thereby reducing the chances of solids migration.
<input type="checkbox"/>	An underdrain cleanout with a minimum 6-inch diameter and lockable cap is placed every 250 to 300 feet as required based on underdrain length.	Properly spaced cleanouts will facilitate underdrain maintenance.

Conceptual Design and Sizing Approach for Site Design

- 1) Determine the areas where vegetated swales can be used in the site design to replace traditional curb and gutter facilities and provide volume reduction through infiltration.

Conceptual Design and Sizing Approach for Storm Water Pollutant Control Only

To design vegetated swales for storm water pollutant control only, the following steps should be taken:

- 1) Verify that siting and design criteria have been met, including bottom width and longitudinal and side slope requirements.
- 2) Calculate the design flow rate per Appendix B based on expected site design runoff for tributary areas.
- 3) Use the sizing worksheet to determine flow-through treatment sizing of the vegetated swale and if flow velocity, flow depth, and hydraulic residence time meet required criteria. Swale configuration should be adjusted as necessary to meet design requirements.

Maintenance Overview

Normal Expected Maintenance. Vegetated swales require routine maintenance to: remove accumulated materials such as sediment, trash, and debris; maintain vegetation health; and maintain integrity of side slopes, channel bottom, inlets, energy dissipaters, weirs or check dams, and outlets to ensure runoff will be conveyed as uniform flow throughout the swale (i.e., flow will spread uniformly across the width of the swale as it is conveyed from upstream to downstream).

Non-Standard Maintenance or BMP Failure. If any of the following scenarios are observed, the BMP is not performing as intended to protect downstream waterways from pollution and/or erosion. Corrective maintenance, increased inspection and maintenance, BMP replacement, or a different BMP type will be required.

- The BMP is not drained between storm events. Surface ponding longer than approximately 24 hours following a storm event may be detrimental to vegetation health, and surface ponding longer than approximately 96 hours following a storm event poses a risk of vector (mosquito) breeding. Poor drainage can result from deposited materials or overgrowth of vegetation within the swale blocking drainage conveyance or blocking an outlet structure, or localized erosion issues that cause channelization and prevent uniform flow throughout the swale. The specific cause of the drainage issue must be determined and corrected. If the issue is not corrected by restoring the BMP to the original plan and grade, the Authority shall be contacted prior to any additional repairs or reconstruction.
- Sediment, trash, or debris accumulation blocking drainage becomes a chronic issue observed at every inspection. This means the load from the tributary drainage area is too high, reducing BMP function or clogging the BMP. This would require pretreatment measures within the tributary area draining to the BMP to intercept the materials.
- Erosion due to concentrated storm water runoff flow that is not readily corrected by adding erosion control blankets, adding stone at flow entry points, or minor re-grading to restore proper drainage according to the original plan. If the issue is not corrected by restoring the BMP to the original plan and grade, the Authority shall be contacted prior to any additional repairs or reconstruction.

Summary of Standard Inspection and Maintenance

The property owner is responsible to ensure inspection, operation and maintenance of permanent BMPs on their property unless responsibility has been formally transferred to the Authority.

Maintenance frequencies listed in this table are average/typical frequencies. Actual maintenance needs are site-specific, and maintenance may be required more frequently. Maintenance must be performed whenever needed, based on maintenance indicators presented in this table. The BMP owner is responsible for conducting regular inspections to see when maintenance is needed based on the maintenance indicators. During the first year of operation of a structural BMP, inspection is recommended at least once prior to August 31 and then monthly from September through May. Inspection during a storm event is also recommended. After the initial period of frequent inspections, the minimum inspection and maintenance frequency can be determined based on the results of the first-year inspections.

Threshold/Indicator	Maintenance Action	Typical Maintenance Frequency
Accumulation of sediment, litter, or debris	Remove and properly dispose of accumulated materials, without damage to vegetation.	<ul style="list-style-type: none"> • Inspect monthly. If accumulated materials are observed blocking drainage, increase inspection frequency to monthly plus after every 0.1-inch or larger storm event. • Remove any accumulated materials found at each inspection.
Obstructed inlet or outlet structure	Clear blockage.	<ul style="list-style-type: none"> • Inspect monthly and after every 0.5-inch or larger storm event. • Remove any accumulated materials found at each inspection.
Damage to structural components such as weirs, inlet or outlet structures	Repair or replace as applicable.	<ul style="list-style-type: none"> • Inspect annually. • Maintain when needed.
Poor vegetation establishment	Re-seed, re-plant, or re-establish vegetation per original plans.	<ul style="list-style-type: none"> • Inspect monthly. • Maintain when needed.
Dead or diseased vegetation	Remove dead or diseased vegetation, re-seed, re-plant, or re-establish vegetation per original plans.	<ul style="list-style-type: none"> • Inspect monthly. • Maintain when needed.

Appendix E: BMP Design Fact Sheets

Threshold/Indicator	Maintenance Action	Typical Maintenance Frequency
Overgrown vegetation	Mow or trim as appropriate.	<ul style="list-style-type: none"> • Inspect monthly. • Maintain when needed.
Erosion due to concentrated irrigation flow	Repair/re-seed/re-plant eroded areas and adjust the irrigation system.	<ul style="list-style-type: none"> • Inspect monthly. • Maintain when needed.
Erosion due to concentrated storm water runoff flow	Repair/re-seed/re-plant eroded areas and make appropriate corrective measures such as adding erosion control blankets, adding stone at flow entry points, or minor re-grading to restore proper drainage according to the original plan. If the issue is not corrected by restoring the BMP to the original plan and grade, the Authority shall be contacted prior to any additional repairs or reconstruction.	<ul style="list-style-type: none"> • Inspect after every 0.5-inch or larger storm event. If erosion due to storm water flow has been observed, increase inspection frequency to after every 0.1-inch or larger storm event. • Maintain when needed. If the issue is not corrected by restoring the BMP to the original plan and grade, the Authority shall be contacted prior to any additional repairs or reconstruction.
Standing water in BMP following a storm event	Make appropriate corrective measures such as adjusting irrigation system, removing obstructions of debris or invasive vegetation, loosening or replacing topsoil to allow for better infiltration, or minor re-grading for proper drainage. If the issue is not corrected by restoring the BMP to the original plan and grade, the Authority shall be contacted prior to any additional repairs or reconstruction.	<ul style="list-style-type: none"> • Inspect monthly and after every 0.5-inch or larger storm event. If standing water is observed, increase inspection frequency to after every 0.1-inch or larger storm event. • Maintain when needed.

Threshold/Indicator	Maintenance Action	Typical Maintenance Frequency
<p>Presence of mosquitos/larvae</p> <p>For images of egg rafts, larva, pupa, and adult mosquitos, see http://www.mosquito.org/biology</p>	<p>If mosquitos/larvae are observed: first, immediately remove any standing water by dispersing to nearby landscaping; second, make corrective measures as applicable to restore BMP drainage to prevent standing water.</p> <p>If mosquitos persist following corrective measures to remove standing water, the Authority shall be contacted to determine a solution. A different BMP type, or a Vector Management Plan prepared with concurrence from the County of San Diego Department of Environmental Health, may be required.</p>	<ul style="list-style-type: none"> • Inspect monthly and after every 0.5-inch or larger storm event. If mosquitos are observed, increase inspection frequency to after every 0.1-inch or larger storm event. • Maintain when needed.

This page intentionally left blank

E.19 FT-2 Media Filters



Photo Credit: Contech Stormwater Solutions

MS4 Permit Category

Flow-through Treatment Control

Manual Category

Flow-through Treatment Control

Applicable Performance Standard

Pollutant Control

Flow Control

Primary Benefits

Treatment

Peak Flow Attenuation (Optional)

Description

Media filters are manufactured devices that consist of a series of modular filters packed with engineered media that can be contained in a catch basin, manhole, or vault that provide treatment through filtration and sedimentation. The manhole or vault may be divided into multiple chambers where the first chamber acts as a pre-settling basin for removal of coarse sediment while the next chamber acts as the filter bay and houses the filter cartridges. A variety of media types are available from various manufacturers that can target pollutants of concern via primarily filtration, sorption, ion exchange, and precipitation. **Specific products must be selected to meet the flow-through BMP selection requirements described in Appendix B.6.** Treatment effectiveness is contingent upon proper maintenance of filter units.

Typical media filter components include:

- Vault for flow storage and media housing
- Inlet and outlet
- Media filters

Design Adaptations for Project Goals

Flow-through treatment BMP for storm water pollutant control. Water quality treatment is provided through filtration. This configuration is considered to provide flow-through treatment, not biofiltration treatment. Storage provided within the vault restricted by an outlet is considered detention storage and is included in calculations for the flow-through treatment volume.

Integrated storm water flow control and pollutant control configuration. Media filters can also be designed for flow rate and duration control via additional detention storage. The vault storage can

be designed to accommodate higher volumes than the storm water pollutant control volume and can utilize multi-stage outlets to mitigate both the duration and rate of flows within a prescribed range.

Design Criteria and Considerations

Media filters must meet the following design criteria. Deviations from the below criteria may be approved at the discretion of the Authority if it is determined to be appropriate:

<i>Siting and Design</i>	<i>Intent/Rationale</i>
<input type="checkbox"/> Placement observes geotechnical recommendations regarding potential hazards (e.g., slope stability, landslides, and liquefaction zones) and setbacks (e.g., slopes, foundations, utilities).	Must not negatively impact existing site geotechnical concerns.
<input type="checkbox"/> Recommended for tributary areas with limited available surface area or where surface BMPs would restrict uses.	Maintenance needs may be more labor intensive for media filters than surface BMPs. Lack of surface visibility creates additional risk that maintenance needs may not be completed in a timely manner.
<input type="checkbox"/> Vault storage drawdown time ≤ 96 hours.	Provides vector control.
<input type="checkbox"/> Vault storage drawdown time ≤ 36 hours if the vault is used for equalization of flows for pollutant treatment.	Provides required capacity to treat back-to-back storms. Exception to the 36-hour drawdown criteria is allowed if additional vault storage is provided using the curves in Appendix B.4.2.
<i>Inflow and Outflow Structures</i>	
<input type="checkbox"/> Inflow and outflow structures are accessible by required equipment (e.g., vector truck) for inspection and maintenance.	Maintenance will prevent clogging and ensure proper operation of the flow control structures.

Conceptual Design and Sizing Approach for Storm Water Pollutant Control Only

To design a media filter for storm water pollutant control only (no flow control required), the following steps should be taken

- 1) Verify that the selected BMP complies with BMP selection requirements in Appendix B.6.
- 2) Verify that placement and tributary area requirements have been met.
- 3) Calculate the required DCV and/or flow rate per Appendix B.6.3 based on expected site design runoff for tributary areas.
- 4) Media filter can be designed either for DCV or flow rate. To estimate the drawdown time, divide the vault storage by the treatment rate of media filters.

Conceptual Design and Sizing Approach when Storm Water Flow Control is Applicable

If control of flow rates and/or durations is desired on an Authority project, significant vault storage volume will typically be required, and therefore the following steps should be taken prior to determination of storm water pollutant control design. Pre-development and post-project flow rates and durations should be determined as discussed in Chapter 6 of the Copermittees' original Model BMP Design Manual. (As previously indicated in this Manual, development within Authority jurisdiction is not subject to hydromodification management requirements, however this sub-section remains as a reference).

- 1) Verify that placement and tributary area requirements have been met.
- 2) Iteratively determine the vault storage volume required to provide detention storage to reduce flow rates and durations to allowable limits. Flow rates and durations can be controlled from detention storage by altering outlet structure orifice size(s) and/or water control levels. Multi-level orifices can be used within an outlet structure to control the full range of flows to MS4.
- 3) If a media filter cannot fully provide the flow rate and duration control required by this Manual, an upstream or downstream structure with appropriate storage volume such as an underground vault can be used to provide remaining controls.
- 4) After the media filter has been designed to meet flow control requirements, calculations must be completed to verify if storm water pollutant control requirements to treat the DCV have been met.
- 5) Verify that the vault drawdown time is 96 hours or less. To estimate the drawdown time:
 - (a) Divide the vault volume by the filter surface area.
 - (b) Divide the result (a) by the design filter rate.

Maintenance Overview

- 1) **Normal Expected Maintenance.** Media filters require routine maintenance to: remove accumulated materials such as sediment, trash, and debris; replace filter cartridges; and maintain integrity of any internal components such as weirs and piping. A summary table of standard inspection and maintenance indicators is provided within this Fact Sheet.
- 2) **Non-Standard Maintenance or BMP Failure.** The normal expected maintenance described above ensures the BMP functionality. Lapses in the normal expected maintenance can lead to clogging of the BMP and potentially blocking the storm drain system. If clogging is observed, the BMP is not performing as intended to protect downstream waterways from pollution and/or erosion. In addition, clogged BMPs can lead to flooding, standing water and mosquito breeding habitat. Maintenance is critical to ensure the flood protection capacity of the storm drain system is not compromised. If proper routine maintenance is not performed, corrective maintenance and increased inspection and maintenance will be required. For persistent clogging or presence of mosquitos, contact the Authority to determine a permanent solution. For example, adding pretreatment measures within the tributary area draining to the BMP to intercept sediment, trash, and debris. Pretreatment components, especially for sediment, will extend the life of the filter media. For mosquitos, a Vector Management Plan, prepared with

concurrence from the County of San Diego Department of Environmental Health, may be required.

- 3) **Other Special Considerations.** Media filters are proprietary systems that include proprietary media that must be replaced as part of normal expected maintenance. They are typically installed underground and may require entry into the underground vault to perform the maintenance. The BMP owner is responsible to hire a maintenance operator qualified to service the units. The maintenance operator must obtain the appropriate filter media and/or any parts that need to be replaced. If maintenance conditions require maintenance personnel to enter the underground structure, the maintenance personnel must be trained and certified in confined space entry. To find a qualified maintenance operator, the BMP owner shall contact the manufacturer of the proprietary BMP.
- 4) The design of media filters includes consideration of the specific pollutants expected from the area tributary to the media filter and the specific pollutants of concern for the downstream waterways. Therefore, it is expected that the filter media selected during design of the project will not be substituted. If a need arises to substitute a different filter configuration or filter media, the Authority shall be contacted prior to any changes.

Summary of Standard Inspection and Maintenance

The property owner is responsible to ensure inspection, operation, and maintenance of permanent BMPs on their property unless responsibility has been formally transferred to the Authority.

Maintenance frequencies listed in this table are average/typical frequencies. Actual maintenance needs are site-specific, and maintenance may be required more frequently. Maintenance must be performed whenever needed, based on maintenance indicators presented in this table. The BMP owner is responsible for conducting regular inspections to see when maintenance is needed based on the maintenance indicators. During the first year of operation of a structural BMP, inspection is recommended at least once prior to August 31 and then monthly from September through May. Inspection during a storm event is also recommended. After the initial period of frequent inspections, the minimum inspection and maintenance frequency can be determined based on the results of the first-year inspections.

Threshold/Indicator	Maintenance Action	Typical Maintenance Frequency
Accumulation of sediment, litter, or debris. The threshold for removal of materials depends on the specific type of proprietary filter and configuration and shall be based on the manufacturer’s recommendation. In any case, materials must be removed if accumulation blocks flow through the BMP.	Remove and properly dispose of accumulated materials.	<ul style="list-style-type: none"> • Inspect monthly. • Remove materials annually (minimum), or more frequently when BMP reaches manufacturer’s threshold for removal of materials in less than one year, or if accumulation blocks outlet.

Appendix E: BMP Design Fact Sheets

Threshold/Indicator	Maintenance Action	Typical Maintenance Frequency
<p>Spent or clogged filter media. The threshold for changing media depends on the specific type of proprietary media and shall be based on the manufacturer's recommendation. In any case, media must be replaced if flow cannot pass through the media or passes through at less than the design capacity.</p>	<p>Remove and properly dispose filter media and replace with fresh media.</p>	<ul style="list-style-type: none"> • Inspect condition of media annually or more frequently if recommended by manufacturer. • Inspect BMP drainage monthly and after every 0.5-inch or larger storm event. If standing water has been observed, increase inspection frequency to after every 0.1-inch or larger storm event. • Maintain when needed based on manufacturer's threshold/indicator for the specific media, or if standing water in the BMP indicates flow cannot pass through the media.
<p>Any other recommendations pursuant to the proprietary filter manufacturer's maintenance guide.</p>	<p>Any other actions pursuant to the proprietary filter manufacturer's maintenance guide.</p>	<ul style="list-style-type: none"> • As recommended by the proprietary filter manufacturer's maintenance guide
<p>Obstructed inlet or outlet structure</p>	<p>Clear blockage.</p>	<ul style="list-style-type: none"> • Inspect monthly and after every 0.5-inch or larger storm event. • Remove any accumulated materials found at each inspection.

Threshold/Indicator	Maintenance Action	Typical Maintenance Frequency
<p>Presence of mosquitos/larvae</p> <p>For images of egg rafts, larva, pupa, and adult mosquitos, see http://www.mosquito.org/biology</p>	<p>If mosquitos/larvae are observed: first, immediately remove and properly dispose any standing water; second, remove any accumulated materials that obstruct flow through the BMP to restore BMP drainage to prevent standing water. Ensure access covers are tight fitting, with gaps or holes no greater than 1/16 inch, and/or install barriers such as inserts or screens that prevent mosquito access to the subsurface storage.</p> <p>If the BMP includes a permanent sump, contact the Authority to determine a permanent solution. A different BMP type, or a Vector Management Plan prepared with concurrence from the County of San Diego Department of Environmental Health, may be required.</p>	<ul style="list-style-type: none"> • Inspect monthly and after every 0.5-inch or larger storm event. If mosquitos are observed, increase inspection frequency to after every 0.1-inch or larger storm event. • Maintain when needed.
<p>Damage to structural components of the filtration system such as weirs, underdrains, inlet or outlet structures</p>	<p>Repair or replace as applicable.</p>	<ul style="list-style-type: none"> • Inspect annually. • Maintain when needed.

This page intentionally left blank

E.20 FT-3 Sand Filters



Photo Credit: City of San Diego LID Manual

MS4 Permit Category

Flow-through Treatment Control

Manual Category

Flow-through Treatment Control

Applicable Performance Standard

Pollutant Control

Flow Control

Description

Sand filters operate by filtering storm water through a constructed sand bed with an underdrain system. Runoff enters the filter and spreads over the surface. Sand filter beds can be enclosed within concrete structures or within earthen containment. As flows increase, water backs up on the surface of the filter where it is held until it can percolate through the sand. The treatment pathway is downward (vertical) through the media to an underdrain system that is connected to the downstream storm drain system. As storm water passes through the sand, pollutants are trapped on the surface of the filter, in the small pore spaces between sand grains or are adsorbed to the sand surface. The high filtration rates of sand filters, which allow a large runoff volume to pass through the media in a short amount of time, can provide efficient treatment for storm water runoff.

Typical sand filter components include:

- Forebay for pretreatment/energy dissipation
- Surface ponding for captured flows
- Sand filter bed
- Aggregate storage layer with underdrain(s)
- Overflow structure

Primary Benefits

Treatment

Volume Reduction (Incidental)

Peak Flow Attenuation (Optional)

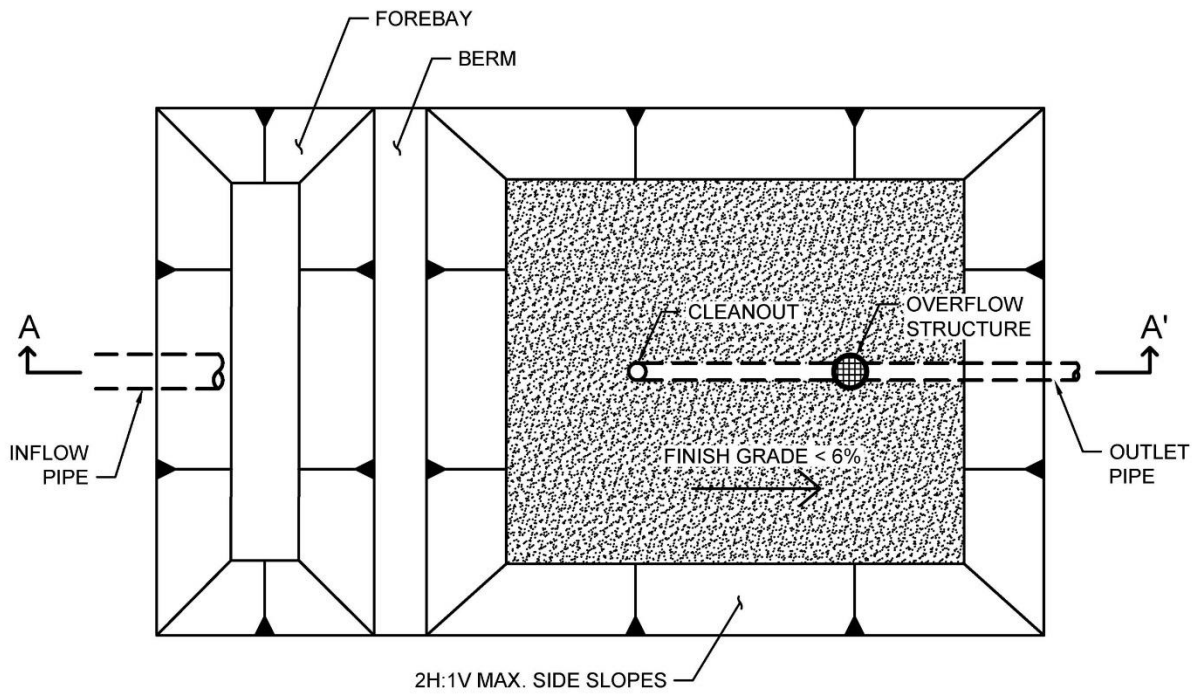

PLAN
NOT TO SCALE

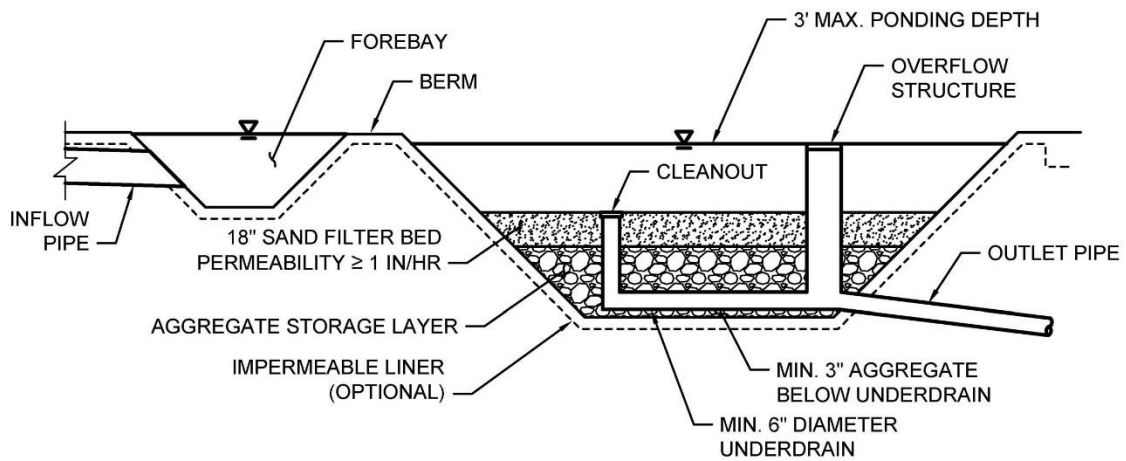

SECTION A-A'
NOT TO SCALE

Typical Plan and Section View of a Sand Filter BMP

Design Adaptations for Project Goals

Flow-through treatment BMP for storm water pollutant control. The system is lined or un-lined to provide incidental infiltration, and an underdrain is provided at the bottom to carry away filtered runoff. This configuration is considered to provide flow-through treatment via vertical flow through the sand filter bed. Storage provided above the underdrain within surface ponding, the sand filter bed, and aggregate storage is considered included in the flow-through treatment volume. Saturated storage within the aggregate storage layer can be added to this design by including an upturned elbow installed at the downstream end of the underdrain or via an internal weir structure designed to maintain a specific water level elevation.

Integrated storm water flow control and pollutant control configuration. The system can be designed to provide flow rate and duration control by primarily providing increased surface ponding and/or having a deeper aggregate storage layer above the underdrain. This will allow for significant detention storage, which can be controlled via inclusion of an outlet structure at the downstream end of the underdrain.

Design Criteria and Considerations

Sand filters must meet the following design criteria. Deviations from the below criteria may be approved at the discretion of the Authority if it is determined to be appropriate:

<i>Siting and Design</i>	<i>Intent/Rationale</i>
<input type="checkbox"/> Placement observes geotechnical recommendations regarding potential hazards (e.g., slope stability, landslides, and liquefaction zones) and setbacks (e.g., slopes, foundations, utilities).	Must not negatively impact existing site geotechnical concerns.
<input type="checkbox"/> An impermeable liner or other hydraulic restriction layer is included if site constraints indicate that infiltration or lateral flows should not be allowed.	Lining prevents storm water from impacting groundwater and/or sensitive environmental or geotechnical features. Incidental infiltration, when allowable, can aid in pollutant removal and groundwater recharge.
<input type="checkbox"/> Contributing tributary area (≤ 5 acres).	Bigger BMPs require additional design features for proper performance. Contributing tributary area greater than 5 acres may be allowed at the discretion of the Authority if the following conditions are met: 1) incorporate design features (e.g., flow spreaders) to minimizing short circuiting of flows in the BMP and 2) incorporate additional design features requested by the Authority for proper performance of the regional BMP.
<input type="checkbox"/> Finish grade of facility is $< 6\%$.	Flatter surfaces reduce erosion and channelization within the facility.

Appendix E: BMP Design Fact Sheets

<i>Siting and Design</i>	<i>Intent/Rationale</i>
<input type="checkbox"/> Earthen side slopes are $\geq 3H:1V$.	Gentler side slopes are safer, less prone to erosion, able to establish vegetation more quickly and easier to maintain.
<input type="checkbox"/> Surface ponding is limited to a 36-hour drawdown time.	Provides required capacity to treat back-to-back storms. Exception to the 36-hour drawdown criteria is allowed if additional surface storage is provided using the curves in Appendix B.4.2.
<input type="checkbox"/> Surface ponding is limited to a 96-hour drawdown time.	Prolonged surface ponding can create a vector hazard.
<input type="checkbox"/> Maximum ponding depth does not exceed 3 feet.	Surface ponding capacity lowers subsurface storage requirements and results in lower cost facilities. Deep surface ponding raises safety concerns.
<input type="checkbox"/> Sand filter bed consists of clean washed concrete or masonry sand (passing $\frac{1}{4}$ inch sieve) or sand similar to the ASTM C33 gradation.	Washing sand will help eliminate fines that could clog the void spaces of the aggregate storage layer.
<input type="checkbox"/> Sand filter bed permeability is at least 1 inch/hour.	A high filtration rate through the media allows flows to quickly enter the aggregate storage layer, thereby minimizing bypass.
<input type="checkbox"/> Sand filter bed depth is at least 18 inches deep.	Different pollutants are removed in various zones of the media using several mechanisms. Some pollutants bound to sediment, such as metals, are typically removed within 18 inches of the media.
<input type="checkbox"/> Aggregate storage should be washed, bank-run gravel.	Washing aggregate will help eliminate fines that could clog the aggregate storage layer void spaces or subgrade.
<input type="checkbox"/> The depth of aggregate provided (12-inch typical) and storage layer configuration is adequate for providing conveyance for underdrain flows to the outlet structure.	Proper storage layer configuration and underdrain placement will minimize facility drawdown time.
<input type="checkbox"/> Inflow, underdrains and outflow structures are accessible for inspection and maintenance.	Maintenance will prevent clogging and ensure proper operation of the flow control structures.
<input type="checkbox"/> Inflow must be non-erosive sheet flow (≤ 3 ft/s) unless an energy-dissipation device, flow diversion/splitter or forebay is installed.	Concentrated flow and/or excessive volumes can cause erosion in a sand filter and can be detrimental to the treatment capacity of the system.
<input type="checkbox"/> Underdrain outlet elevation should be a minimum of 3 inches above the bottom elevation of the aggregate storage layer.	A minimal separation from subgrade or the liner lessens the risk of fines entering the underdrain and can improve hydraulic performance by allowing perforations to remain unblocked.

<i>Siting and Design</i>	<i>Intent/Rationale</i>
<input type="checkbox"/> Minimum underdrain diameter is 6 inches.	Smaller diameter underdrains are prone to clogging.
<input type="checkbox"/> Underdrains should be made of slotted, PVC pipe conforming to ASTM D 3034 or equivalent or corrugated, HDPE pipe conforming to AASHTO 252M or equivalent.	Slotted underdrains provide greater intake capacity, clog resistant drainage, and reduced entrance velocity into the pipe, thereby reducing the chances of solids migration.
<input type="checkbox"/> Overflow is safely conveyed to a downstream storm drain system or discharge point.	Planning for overflow lessens the risk of property damage due to flooding.

Conceptual Design and Sizing Approach for Storm Water Pollutant Control Only

To design a sand filter for storm water pollutant control only (no flow control required), the following steps should be taken:

- 1) Verify that siting and design criteria have been met, including placement requirements, contributing tributary area, and maximum finish grade slope.
- 2) Calculate the required DCV and/or flow rate per Appendix B.6.3 based on expected site design runoff for tributary areas.
- 3) Sand filter can be designed either for DCV or flow rate. To estimate the drawdown time, divide the average ponding depth by the permeability of the filter sand.

Conceptual Design and Sizing Approach when Storm Water Flow Control is Applicable

If control of flow rates and/or durations is desired on an Authority project, significant surface ponding and/or aggregate storage volumes will typically be required, and therefore the following steps should be taken prior to determination of storm water pollutant control design. Pre-development and post-project flow rates and durations should be determined as discussed in Chapter 6 of the Copermittees' original Model BMP Design Manual. (As previously indicated in this Manual, development within Authority jurisdiction is not subject to hydromodification management requirements, however this sub-section remains as a reference).

- 1) Verify that siting and design criteria have been met, including placement requirements, contributing tributary area, and maximum finish grade slope.
- 2) Iteratively determine the facility footprint area, surface ponding and/or aggregate storage layer depth required to provide detention storage to reduce flow rates and durations to allowable limits. Flow rates and durations can be controlled from detention storage by altering outlet structure orifice size(s) and/or water control levels. Multi-level orifices can be used within an outlet structure to control the full range of flows.
- 3) If a sand filter cannot fully provide the flow rate and duration control required by the MS4 permit, an upstream or downstream structure with appropriate storage volume such as an underground vault can be used to provide remaining controls.

- 4) After the sand filter has been designed to meet flow control requirements, calculations must be completed to verify if storm water pollutant control requirements to treat the DCV have been met.

Maintenance Overview

- 1) **Normal Expected Maintenance.** Sand filters require routine maintenance to: remove accumulated materials such as sediment, trash, and debris from the forebay; and clear the underdrain(s). To ensure runoff is passed through the sand bed, sand at the top of the sand bed (approximately 2 inches, or more if necessary) must be removed and replaced to restore flow when the drain time exceeds 24-96 hours. A summary table of standard inspection and maintenance indicators is provided within this Fact Sheet.
- 2) **Non-Standard Maintenance or BMP Failure.** The normal expected maintenance described above ensures the BMP functionality. Lapses in the normal expected maintenance can lead to clogging of the BMP and runoff bypassing the filter. If clogging is observed, the BMP is not performing as intended to protect downstream waterways from pollution and/or erosion. In addition, clogged BMPs can lead to flooding, standing water and mosquito breeding habitat. Corrective maintenance and increased inspection and maintenance will be required. For persistent clogging or presence of mosquitos, contact the Authority to determine a permanent solution. For example, adding pretreatment measures within the tributary area draining to the BMP to intercept sediment, trash, and debris. Pretreatment components, especially for sediment, will extend the life of the sand bed. For mosquitos, a Vector Management Plan, prepared with concurrence from the County of San Diego Department of Environmental Health, may be required.

Summary of Standard Inspection and Maintenance

The property owner is responsible to ensure inspection, operation and maintenance of permanent BMPs on their property unless responsibility has been formally transferred to the Authority.

Maintenance frequencies listed in this table are average/typical frequencies. Actual maintenance needs are site-specific, and maintenance may be required more frequently. Maintenance must be performed whenever needed, based on maintenance indicators presented in this table. The BMP owner is responsible for conducting regular inspections to see when maintenance is needed based on the maintenance indicators. During the first year of operation of a structural BMP, inspection is recommended at least once prior to August 31 and then monthly from September through May. Inspection during a storm event is also recommended. After the initial period of frequent inspections, the minimum inspection and maintenance frequency can be determined based on the results of the first-year inspections.

Threshold/Indicator	Maintenance Action	Typical Maintenance Frequency
Accumulation of sediment, litter, or debris in forebay and/or filter bed	Remove and properly dispose of accumulated materials.	<ul style="list-style-type: none"> • Inspect monthly. If the forebay is 25% full or more in one month, increase inspection frequency to monthly plus after every 0.1-inch or larger storm event. • Remove any accumulated materials found within the filter bed at each inspection. • When the BMP includes a forebay, materials must be removed from the forebay when the forebay is 25% full*, or if accumulation within the forebay blocks flow to the filter bed.
Standing water in BMP for longer than 24-96 hours following a storm event	Make appropriate corrective measures to restore drainage such as removing obstructions of debris from the forebay, clearing underdrains or repairing/replacing clogged sand bed.	<ul style="list-style-type: none"> • Inspect monthly and after every 0.5-inch or larger storm event. If standing water is observed, increase inspection frequency to after every 0.1-inch or larger storm event. • Maintain when needed.

Appendix E: BMP Design Fact Sheets

Threshold/Indicator	Maintenance Action	Typical Maintenance Frequency
<p>Clogged sand bed This is indicated when the drain time of the surface of the sand bed exceeds 24-96 hours.</p>	<p>Remove and properly dispose sand from the top of the sand bed (approximately 2 inches of sand, or as much as needed to restore flow). Restore sand depth to the design depth.</p>	<ul style="list-style-type: none"> • Inspect monthly and after every 0.5-inch or larger storm event. If standing water is observed, increase inspection frequency to after every 0.1-inch or larger storm event. • Maintain when needed.
<p>Obstructed inlet or outlet structure</p>	<p>Clear blockage.</p>	<ul style="list-style-type: none"> • Inspect monthly and after every 0.5-inch or larger storm event. • Remove any accumulated materials found at each inspection.
<p>Presence of mosquitos/larvae For images of egg rafts, larva, pupa, and adult mosquitos, see http://www.mosquito.org/biology</p>	<p>If mosquitos/larvae are observed: first, immediately remove and properly dispose any standing water by dispersing to nearby landscaping; second, make corrective measures as applicable to restore BMP drainage to prevent standing water. If mosquitos persist following corrective measures to remove standing water, the Authority shall be contacted to determine a solution. A different BMP type, or a Vector Management Plan prepared with concurrence from the County of San Diego Department of Environmental Health, may be required.</p>	<ul style="list-style-type: none"> • Inspect monthly and after every 0.5-inch or larger storm event. If mosquitos are observed, increase inspection frequency to after every 0.1-inch or larger storm event. • Maintain when needed
<p>Damage to structural components of the BMP such as weirs, underdrains, inlet or outlet structures</p>	<p>Repair or replace as applicable.</p>	<ul style="list-style-type: none"> • Inspect annually. • Maintain when needed.

E.21 FT-4 Dry Extended Detention Basin



Location: Rolling Hills Ranch, Chula Vista, California; Photo Credit: Eric Mosolgo

MS4 Permit Category

Flow-through Treatment Control

Manual Category

Flow-through Treatment Control

Applicable Performance Standard

Pollutant Control

Flow Control

Primary Benefits

Treatment

Volume Reduction (Incidental)

Peak Flow Attenuation

Description

Dry extended detention basins are basins that have been designed to detain storm water for an extended period to allow sedimentation and typically drain completely between storm events. A portion of the dissolved pollutant load may also be removed by filtration, uptake by vegetation, and/or through infiltration. The slopes, bottom, and forebay of dry extended detention basins are typically vegetated. Considerable storm water volume reduction can occur in dry extended detention basins when they are located in permeable soils and are not lined with an impermeable barrier. Dry extended detention basins are generally appropriate for developments of ten acres or larger, and have the potential for multiple uses including parks, playing fields, tennis courts, open space, and overflow parking lots. They can also be used to provide flow control by modifying the outlet control structure and providing additional detention storage.

Typical dry extended detention basins components include:

- Forebay for pretreatment
- Surface ponding for captured flows
- Vegetation selected based on basin use, climate, and ponding depth
- Low flow channel, outlet, and overflow device
- Impermeable liner or uncompacted native soils at the bottom of the facility

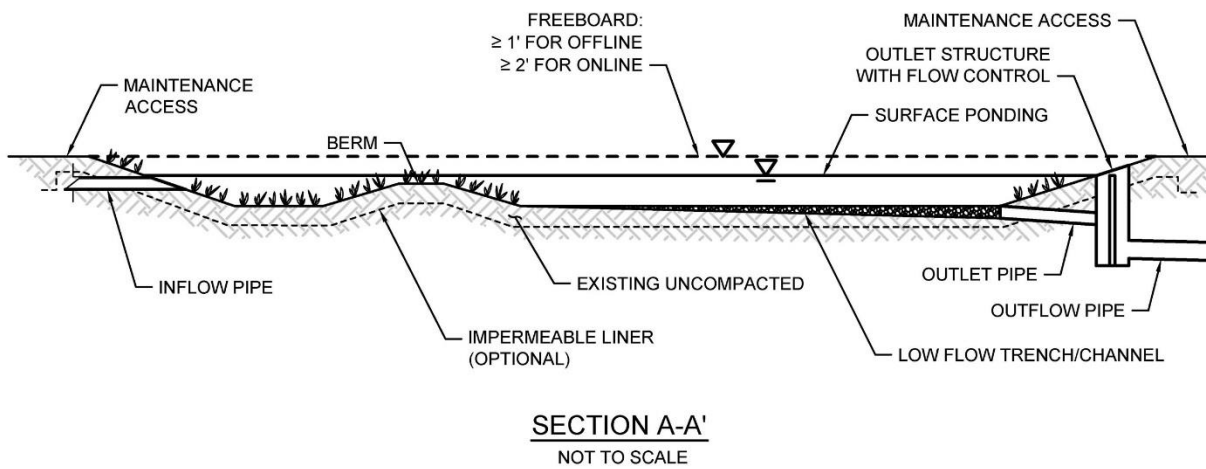
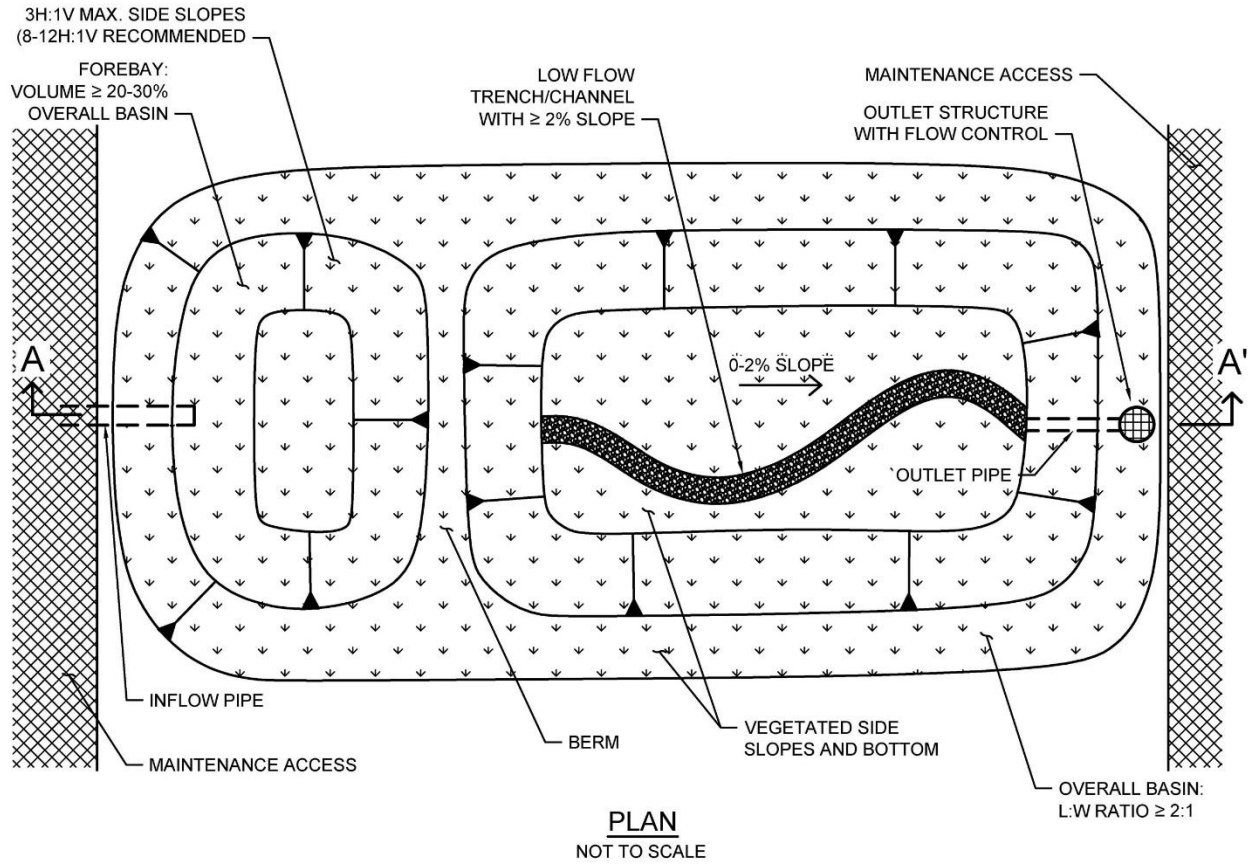

Typical Plan and Section View of a Dry Extended Detention Basin BMP

Design Adaptations for Project Goals

Flow-through treatment BMP for storm water pollutant control. The system is lined or un-lined to provide incidental infiltration and designed to detain storm water to allow particulates and associated pollutants to settle out. This configuration is considered to provide flow-through treatment, not biofiltration treatment. Storage provided as surface ponding above a restricted outlet invert is considered detention storage and is included in calculations for the flow-through treatment volume.

Integrated storm water flow control and pollutant control configuration. Dry extended detention basins can also be designed for flow control. The surface ponding can be designed to accommodate higher volumes than the storm water pollutant control volume and can utilize multi-stage outlets to mitigate both the duration and rate of flows within a prescribed range.

Design Criteria and Considerations

Dry extended detention basins must meet the following design criteria. Deviations from the below criteria may be approved at the discretion of the Authority if it is determined to be appropriate:

<i>Siting and Design</i>	<i>Intent/Rationale</i>
<input type="checkbox"/> Placement observes geotechnical recommendations regarding potential hazards (e.g., slope stability, landslides, and liquefaction zones) and setbacks (e.g., slopes, foundations, utilities).	Must not negatively impact existing site geotechnical concerns.
<input type="checkbox"/> An impermeable liner or other hydraulic restriction layer is included if site constraints indicate that infiltration or lateral flows should not be allowed.	Lining prevents storm water from impacting groundwater and/or sensitive environmental or geotechnical features. Incidental infiltration, when allowable, can aid in pollutant removal and groundwater recharge.
<input type="checkbox"/> Contributing tributary area is large (typically ≥ 10 acres).	Dry extended detention basins require significant space and are more cost-effective for treating larger drainage areas.
<input type="checkbox"/> Longitudinal basin bottom slope is 0 - 2%.	Flatter slopes promote ponding and settling of particles.
<input type="checkbox"/> Basin length to width ratio is $\geq 2:1$ (L:W).	A larger length to width ratio provides a longer flow path to promote settling.
<input type="checkbox"/> Forebay is included that encompasses 20 - 30% of the basin volume.	A forebay to trap sediment can decrease frequency of required maintenance.
<input type="checkbox"/> Side slopes are $\geq 3H:1V$.	Gentler side slopes are safer, less prone to erosion, able to establish vegetation more quickly and easier to maintain.
<input type="checkbox"/> Surface ponding drawdown time is between 24 and 96 hours.	Minimum drawdown time of 24 hours allows for adequate settling time and maximizes pollutant removal. Maximum drawdown time of 96 hours provides vector control.

<i>Siting and Design</i>		<i>Intent/Rationale</i>
<input type="checkbox"/>	Minimum freeboard provided is ≥ 1 foot for offline facilities and ≥ 2 feet for online facilities.	Freeboard provides room for head over overflow structures and minimizes risk of uncontrolled surface discharge.
<input type="checkbox"/>	Inflow and outflow structures are accessible by required equipment (e.g., vector truck) for inspection and maintenance.	Maintenance will prevent clogging and ensure proper operation of the flow control structures.
<input type="checkbox"/>	A low flow channel or trench with a $\geq 2\%$ slope is provided. A gravel infiltration trench is provided where infiltration is allowable.	Aids in draining or infiltrating dry weather flows.
<input type="checkbox"/>	Overflow is safely conveyed to a downstream storm drain system or discharge point. Size overflow structure to pass 100-year peak flow.	Planning for overflow lessens the risk of property damage due to flooding.
<input type="checkbox"/>	The maximum rate at which runoff is discharged is set below the erosive threshold for the site.	Extended low flows can have erosive effects.

Conceptual Design and Sizing Approach for Storm Water Pollutant Control Only

To design dry extended detention basins for storm water pollutant control only (no flow control required), the following steps should be taken:

- 1) Verify that siting and criteria have been met, including placement requirements, contributing tributary area, forebay volume, and maximum slopes for basin sides and bottom.
- 2) Calculate the DCV per Appendix B based on expected site design runoff for tributary areas.
- 3) Use the sizing worksheet to determine flow-through treatment sizing of the surface ponding of the dry extended detention basin, which includes calculations for a maximum 96-hour drawdown time.

Conceptual Design and Sizing Approach when Storm Water Flow Control is Applicable

If control of flow rates and/or durations is desired on an Authority project, significant surface ponding volume will typically be required, and therefore the following steps should be taken prior to determination of storm water pollutant control design. Pre-development and post-project flow rates and durations should be determined as discussed in Chapter 6 of the Copermittees' original Model BMP Design Manual. (As previously indicated in this Manual, development within Authority jurisdiction is not subject to hydromodification management requirements, however this sub-section remains as a reference).

- 1) Verify that siting and criteria have been met, including placement requirements, tributary area, and maximum slopes for basin sides and bottom.
- 2) Iteratively determine the surface ponding required to provide detention storage to reduce flow rates and durations to allowable limits. Flow rates and durations can be controlled from detention storage by altering outlet structure orifice size(s) and/or water control levels. Multi-level orifices can be used within an outlet structure to control the full range of flows.

- 3) If a dry extended detention basin cannot fully provide the flow rate and duration control required by this Manual, an upstream or downstream structure with appropriate storage volume such as an additional basin or underground vault can be used to provide remaining controls.
- 4) After the dry extended detention basin has been designed to meet flow control requirements, calculations must be completed to verify if storm water pollutant control requirements to treat the DCV have been met.

Maintenance Overview

Normal Expected Maintenance. Dry extended detention basins require routine maintenance to: remove accumulated materials such as sediment, trash or debris; maintain vegetation health; and maintain integrity of side slopes, inlets, energy dissipators, and outlets. A summary table of standard inspection and maintenance indicators is provided within this Fact Sheet.

Non-Standard Maintenance or BMP Failure. If any of the following scenarios are observed, the BMP is not performing as intended to protect downstream waterways from pollution and/or erosion. Corrective maintenance, increased inspection and maintenance, BMP replacement, or a different BMP type will be required.

- The BMP is not drained between storm events. Surface ponding longer than approximately 24 hours following a storm event may be detrimental to vegetation health, and surface or underground ponding longer than approximately 96 hours following a storm event poses a risk of vector (mosquito) breeding. Poor drainage can result from clogging of underlying native soils and/or the outlet structure. The specific cause of the drainage issue must be determined and corrected. If it is determined that the drainage of the basin relies on infiltration and the underlying native soils have been compacted or do not have the infiltration capacity expected, the Authority shall be contacted prior to any additional repairs or reconstruction.
- Sediment, trash, or debris accumulation greater than 25 percent of the surface ponding volume within one month. This means the load from the tributary drainage area is too high, reducing BMP function or clogging the BMP. This would require pretreatment measures within the tributary area draining to the BMP to intercept the materials.
- Erosion due to concentrated storm water runoff flow that is not readily corrected by adding erosion control blankets, adding stone at flow entry points, or minor re-grading to restore proper drainage according to the original plan. If the issue is not corrected by restoring the BMP to the original plan and grade, the Authority shall be contacted prior to any additional repairs or reconstruction.

Other Special Considerations. Some above-ground dry extended detention basins are vegetated structural BMPs. Vegetated structural BMPs that are constructed in the vicinity of, or connected to, an existing jurisdictional water or wetland could inadvertently result in creation of expanded waters or wetlands. As such, vegetated structural BMPs have the potential to come under the jurisdiction of the United States Army Corps of Engineers, SDRWQCB, California Department of Fish and Wildlife, or the United States Fish and Wildlife Service. This could result in the need for specific resource agency permits and costly mitigation to perform maintenance of the structural BMP. Along with proper placement of a structural BMP, routine maintenance is key to preventing this scenario.

Appendix E: BMP Design Fact Sheets

Underground dry extended detention basins are typically designed to be cleaned from above-ground using a vactor. If maintenance conditions require maintenance personnel to enter the underground structure, the maintenance personnel must be trained and certified in confined space entry.

Summary of Standard Inspection and Maintenance

The property owner is responsible to ensure inspection, operation and maintenance of permanent BMPs on their property unless responsibility has been formally transferred to the Authority.

Maintenance frequencies listed in this table are average/typical frequencies. Actual maintenance needs are site-specific, and maintenance may be required more frequently. Maintenance must be performed whenever needed, based on maintenance indicators presented in this table. The BMP owner is responsible for conducting regular inspections to see when maintenance is needed based on the maintenance indicators. During the first year of operation of a structural BMP, inspection is recommended at least once prior to August 31 and then monthly from September through May. Inspection during a storm event is also recommended. After the initial period of frequent inspections, the minimum inspection and maintenance frequency can be determined based on the results of the first-year inspections.

Threshold/Indicator	Maintenance Action	Typical Maintenance Frequency
Accumulation of sediment, litter, or debris in forebay and/or basin	Remove and properly dispose of accumulated materials, (without damage to vegetation when applicable).	<ul style="list-style-type: none"> • Inspect monthly. If the forebay is 25% full* or more in one month, increase inspection frequency to monthly plus after every 0.1-inch or larger storm event. • Remove any accumulated materials found within the basin area at each inspection. • When the BMP includes a forebay, materials must be removed from the forebay when the forebay is 25% full*, or if accumulation within the forebay blocks flow to the basin.
Obstructed inlet or outlet structure	Clear blockage.	<ul style="list-style-type: none"> • Inspect monthly and after every 0.5-inch or larger storm event. • Remove any accumulated materials found at each inspection.
Poor vegetation establishment (when the BMP includes vegetated surface by design)	Re-seed, re-plant, or re-establish vegetation per original plans.	<ul style="list-style-type: none"> • Inspect monthly. • Maintain when needed.

Appendix E: BMP Design Fact Sheets

Threshold/Indicator	Maintenance Action	Typical Maintenance Frequency
Dead or diseased vegetation (when the BMP includes vegetated surface by design)	Remove dead or diseased vegetation, re-seed, re-plant, or re-establish vegetation per original plans.	<ul style="list-style-type: none"> • Inspect monthly. • Maintain when needed.
Overgrown vegetation (when the BMP includes vegetated surface by design)	Mow or trim as appropriate.	<ul style="list-style-type: none"> • Inspect monthly. • Maintain when needed.
Erosion due to concentrated irrigation flow	Repair/re-seed/re-plant eroded areas and adjust the irrigation system.	<ul style="list-style-type: none"> • Inspect monthly. • Maintain when needed.
Erosion due to concentrated storm water runoff flow	Repair/re-seed/re-plant eroded areas and make appropriate corrective measures such as adding erosion control blankets, adding stone at flow entry points, or minor re-grading to restore proper drainage according to the original plan. If the issue is not corrected by restoring the BMP to the original plan and grade, the Authority shall be contacted prior to any additional repairs or reconstruction.	<ul style="list-style-type: none"> • Inspect after every 0.5-inch or larger storm event. If erosion due to storm water flow has been observed, increase inspection frequency to after every 0.1-inch or larger storm event. • Maintain when needed. If the issue is not corrected by restoring the BMP to the original plan and grade, the Authority shall be contacted prior to any additional repairs or reconstruction.

Appendix E: BMP Design Fact Sheets

Threshold/Indicator	Maintenance Action	Typical Maintenance Frequency
<p>Standing water in above-ground BMP for longer than 24-96 hours following a storm event</p>	<p>Make appropriate corrective measures such as adjusting irrigation system, removing obstructions of debris or invasive vegetation, or removing/replacing clogged or compacted surface treatments and/or scarifying or tilling native soils. Always remove deposited sediments before scarification and use a hand-guided rotary tiller. If it is determined that the drainage of the basin relies on infiltration and the underlying native soils have been compacted or do not have the infiltration capacity expected, the Authority shall be contacted prior to any additional repairs or reconstruction.</p>	<ul style="list-style-type: none"> • Inspect monthly and after every 0.5-inch or larger storm event. If standing water is observed, increase inspection frequency to after every 0.1-inch or larger storm event. • Maintain when needed.
<p>Standing water in underground BMP for longer than 24-96 hours following a storm event</p>	<p>Make appropriate corrective measures such as removing obstructions at the outlet, clearing underdrains, or flushing fine sediment from aggregate layer when applicable. If it is determined that the drainage of the basin relies on infiltration and the underlying native soils have been compacted or do not have the infiltration capacity expected, the Authority shall be contacted prior to any additional repairs or reconstruction.</p>	<ul style="list-style-type: none"> • Inspect monthly and after every 0.5-inch or larger storm event. If standing water is observed, increase inspection frequency to after every 0.1-inch or larger storm event. • Maintain when needed.

Threshold/Indicator	Maintenance Action	Typical Maintenance Frequency
<p>Presence of mosquitos/larvae</p> <p>For images of egg rafts, larva, pupa, and adult mosquitos, see http://www.mosquito.org/biology</p>	<p>If mosquitos/larvae are observed: first, immediately remove and properly dispose any standing water; second, make corrective measures as applicable to restore BMP drainage to prevent standing water. For underground detention basins, ensure access covers are tight fitting, with gaps or holes no greater than 1/16 inch, and/or install barriers such as inserts or screens that prevent mosquito access to the subsurface storage.</p> <p>If mosquitos persist following corrective measures to remove standing water, or if the BMP design does not meet the 96-hour drawdown criteria due to release rates controlled by an orifice installed on the underdrain, the Authority shall be contacted to determine a solution. A different BMP type, or a Vector Management Plan prepared with concurrence from the County of San Diego Department of Environmental Health, may be required.</p>	<ul style="list-style-type: none"> • Inspect monthly and after every 0.5-inch or larger storm event. If mosquitos are observed, increase inspection frequency to after every 0.1-inch or larger storm event. • Maintain when needed
<p>Damage to structural components such as weirs, inlet or outlet structures</p>	<p>Repair or replace as applicable.</p>	<ul style="list-style-type: none"> • Inspect annually. • Maintain when needed.

“25% full” is defined as ¼ of the depth from the design bottom elevation to the crest of the outflow structure (e.g., if the height to the outflow opening is 12 inches from the bottom elevation, then the materials must be removed when there is 3 inches of accumulation – this should be marked on the outflow structure).

E.22 FT-5 Proprietary Flow-Through Treatment Control BMPs

The purpose of this fact sheet is to help explain the potential role of proprietary BMPs in meeting flow thru treatment control BMP requirements. The fact sheet does not describe design criteria like the other fact sheets in this appendix because this information varies by BMP product model.

Criteria for Use of a Proprietary BMP as a Flow-Through Treatment Control BMP

A proprietary BMP may be acceptable as a “flow-through treatment control BMP” under the following conditions:

- 1) The BMP is selected and sized consistent with the method and criteria described in Appendix B.6;
- 2) The BMP is designed and maintained in a manner consistent with its performance certifications (See explanation in Appendix B.6); and
- 3) The BMP is acceptable at the discretion of the Authority. In determining the acceptability of a BMP, the Authority should consider, as applicable, (a) the data submitted; (b) representativeness of the data submitted; (c) consistency of the BMP performance claims with pollutant control objectives; certainty of the BMP performance claims; (d) for projects within the public right of way and/or capital projects: maintenance requirements, cost of maintenance activities, relevant previous local experience with operation and maintenance of the BMP type, ability to continue to operate the system in event that the vending company is no longer operating as a business; and (e) other relevant factors. If a proposed BMP is not accepted by the Authority, a written explanation/reason will be provided to the applicant.

Guidance for Sizing Proprietary BMPs

Proprietary flow-through BMPs must meet the same sizing guidance as other flow-through treatment control BMPs. Guidance for sizing flow-through BMPs to comply with requirements of this Manual is provided in Appendix B.6.

Maintenance Overview

Refer to manufacturer for maintenance information.

This page intentionally left blank

E.23 PL Plant List

Plant Name		Irrigation Requirements		Preferred Location in Basin		Applicable Bioretention Sections (Un-Lined Facilities)				Applicability to Flow-Through Planter? (Lined Facility)	
Latin Name	Common Name	Temporary Irrigation during Plant Establishment Period	Permanent Irrigation (Drip/Spray) ⁽¹⁾	Basin Bottom	Basin Side Slopes	Section A Treatment-Only Bioretention in Hydrologic Soil Group A or B Soils	Section B Treatment-Only Bioretention in Hydrologic Soil Group C or D soils	Section C Treatment Plus Flow Control Bioretention in Hydrologic Soil Group A or B Soils	Section D Treatment Plus Flow Control Bioretention in Hydrologic Soil Group C or D Soils	NO Applicable to Un-lined Facilities Only (Bioretention Only)	YES Can Use in Lined or Un-Lined Facility (Flow-Through Planter OR Bioretention)
TREES⁽²⁾											
Alnus rhombifolia	White Alder	X		X	X	X	X	X	X	X	
Platanus racemosa	California Sycamore	X		X	X	X	X	X	X	X	
Salix lasiolepis	Arroyo Willow	X			X	X	X	X	X	X	
Salix lucida	Lance-Leaf Willow	X			X	X	X	X	X	X	
Sambucus mexicana	Blue Elderberry	X			X	X	X	X	X	X	
SHRUBS/GROUNDCOVER											
Achillea millefolium	Yarrow	X			X	X	X				X
Agrostis palens	Thingrass	X			X	X	X	X	X		X
Anemopsis californica	Yerba Manza	X			X	X	X	X	X		X
Baccharis douglasii	Marsh Baccahris	X	X	X		X	X	X	X		X
Carex praegracillis	California Field Sedge	X	X	X		X	X	X	X		X
Carex spissa	San Diego Sedge	X	X	X		X	X	X	X		X
Carex subfusca	Rusty Sedge	X	X	X	X	X	X	X	X		X
Distichlis spicata	Salt Grass	X	X	X		X	X	X	X		X
Eleocharis macrostachya	Pale Spike Rush	X	X	X		X	X	X	X		X
Festuca rubra	Red Fescue	X	X	X	X	X	X				X
Festuca californica	California Fescue	X	X		X	X	X				X
Iva hayesiana	Hayes Iva	X			X	X	X				X
Juncus Mexicana	Mexican Rush	X	X	X	X	X	X	X	X		X
Jucus patens	California Gray Rush	X	X	X	X	X	X	X	X		X
Leymus condensatus 'Canyon Prince'	Canyon Prince Wild Rye	X	X	X	X	X	X	X	X		X
Mahonia nevinii	Nevin's Barberry	X			X	X	X	X	X		X
Muhlenburgia rigens	Deergrass	X	X	X	X	X	X	X	X		X
Mimulus cardinalis	Scarlet Monkeyflower	X		X	X	X	X				X
Ribes speciosum	Fushia Flowering Goose.	X			X	X	X				X
Rosa californica	California Wild Rose	X	X		X	X	X				X
Scirpus cenusus	Low Bullrush	X	X	X		X	X	X	X		X
Sisyrinchium bellum	Blue-eyed Grass	X			X	X	X				X

1. All plants will benefit from some supplemental irrigation during hot dry summer months, particularly those on basin side slopes and further inland.
 2. All trees should be planted a min. of 10' away from any drainpipes or structures.

This page intentionally left blank

Appendix

F

AUTHORITY BMP DESIGN MANUAL

Biofiltration Standard and Checklist

February 2022

Appendix F Biofiltration Standard and Checklist

Introduction

The MS4 Permit and this Manual define a specific category of storm water pollutant treatment BMPs called “biofiltration BMPs.” The MS4 Permit (Section E.3.c.1) states:

Biofiltration BMPs must be designed to have an appropriate hydraulic loading rate to maximize storm water retention and pollutant removal, as well as to prevent erosion, scour, and channeling within the BMP, and must be sized to:

- 1) **Treat 1.5 times the DCV not reliably retained onsite, OR**
- 2) **Treat the DCV not reliably retained onsite with a flow-through design that has a total volume, including pore spaces and pre-filter detention volume, sized to hold at least 0.75 times the portion of the DCV not reliably retained onsite.**

A project applicant must be able to affirmatively demonstrate that a given BMP is designed and sized in a manner consistent with this definition to be considered as a “biofiltration BMP” as part of a compliant storm water management plan. Retention is defined in the MS4 Permit as evapotranspiration, infiltration, and harvest and use of storm water vs. discharge to a surface water system.

Contents and Intended Uses

This appendix contains a checklist of the key underlying criteria that must be met for a BMP to be considered a biofiltration BMP. The purpose of this checklist is to facilitate consistent review and approval of biofiltration BMPs that meet the “biofiltration standard” defined by the MS4 Permit.

This checklist includes specific design criteria that are essential to defining a system as a biofiltration BMP; however, it does not present a complete design basis. This checklist was used to develop BMP Fact Sheets for PR-1 biofiltration with partial retention and BF-1 biofiltration, which do present a complete design basis. Therefore, biofiltration BMPs that substantially meet all aspects of the Fact sheets PR-1 or BF-1 should be able to complete this checklist without additional documentation beyond what would already be required for a project submittal.

Appendix F: Biofiltration Standard and Checklist

Other biofiltration BMP designs¹ (including both non-proprietary and proprietary designs) may also meet the underlying MS4 Permit requirements to be considered biofiltration BMPs. These BMPs may be classified as biofiltration BMPs if they (1) meet the minimum design criteria listed in this appendix, including the pollutant treatment performance standard in Appendix F.1, (2) are designed and maintained in a manner consistent with their performance certifications (See explanation in Appendix F.2), if applicable, and (3) are acceptable at the discretion of the P&EAD. The applicant may be required to provide additional studies and/or required to meet additional design criteria beyond the scope of this document in order to demonstrate that these criteria are met.

Organization

The checklist in this appendix is organized into the seven (7) main objectives associated with biofiltration BMP design. It describes the associated minimum criteria that must be met in order to qualify a biofiltration BMP as meeting the biofiltration standard. The seven main objectives are listed below. Specific design criteria and associated Manual references associated with each of these objectives is provided in the checklist in the following section.

- 1) Biofiltration BMPs shall be allowed only as described in the BMP selection process in this Manual (i.e., retention feasibility hierarchy).
- 2) Biofiltration BMPs must be sized using acceptable sizing methods described in this Manual.
- 3) Biofiltration BMPs must be sited and designed to achieve maximum feasible infiltration and evapotranspiration.
- 4) Biofiltration BMPs must be designed with a hydraulic loading rate to maximize pollutant retention, preserve pollutant control/sequestration processes, and minimize potential for pollutant washout.
- 5) Biofiltration BMPs must be designed to promote appropriate biological activity to support and maintain treatment processes.
- 6) Biofiltration BMPs must be designed to prevent erosion, scour, and channeling within the BMP.
- 7) Biofiltration BMP must include operations and maintenance design features and planning considerations to provide for continued effectiveness of pollutant and flow control functions.

Biofiltration Criteria Checklist

The applicant shall provide documentation of compliance with each criterion in this checklist as part of the project submittal. The right column of this checklist identifies the submittal information that is recommended to document compliance with each criterion. Biofiltration BMPs that substantially meet

¹ Defined as biofiltration designs that do not conform to the specific design criteria described in Fact Sheets PR-1 or BF-1. This category includes proprietary BMPs that are sold by a vendor as well as non-proprietary BMPs that are designed and constructed of primarily of more elementary construction materials.

Appendix F: Biofiltration Standard and Checklist

all aspects of Fact Sheets PR-1 or BF-1 should still use this checklist; however additional documentation (beyond what is already required for project submittal) should not be required.

1. Biofiltration BMPs shall be allowed to be used only as described in the BMP selection process based on a documented feasibility analysis.

Intent: This Manual defines a specific prioritization of pollutant treatment BMPs, where BMPs that retain water (retained includes evapotranspired, infiltrated, and/or harvested and used) must be used before considering BMPs that have a biofiltered discharge to the MS4 or surface waters. Use of a biofiltration BMP in a manner in conflict with this prioritization (i.e., without a feasibility analysis justifying its use) is not permitted, regardless of the adequacy of the sizing and design of the system.

- | | | |
|--------------------------|---|---|
| <input type="checkbox"/> | The project applicant has demonstrated that it is not technically feasible to retain the full DCV onsite. | Document feasibility analysis and findings in SWQMP per Appendix C. |
|--------------------------|---|---|

2. Biofiltration BMPs must be sized using acceptable sizing methods.

Intent: The MS4 Permit, and this Manual defines specific sizing methods that must be used to size biofiltration BMPs. Sizing of biofiltration BMPs is a fundamental factor in the amount of storm water that can be treated and also influences volume and pollutant retention processes.

- | | | |
|--------------------------|--|---|
| <input type="checkbox"/> | The project applicant has demonstrated that biofiltration BMPs are sized to meet one of the biofiltration sizing options available (Appendix B.5). | Submit sizing worksheets (Appendix B.5) or other equivalent documentation with the SWQMP. |
|--------------------------|--|---|

3. Biofiltration BMPs must be sited and designed to achieve maximum feasible infiltration and evapotranspiration.

Intent: Various decisions about BMP placement and design influence how much water is retained via infiltration and evapotranspiration. The MS4 Permit requires that biofiltration BMPs achieve maximum feasible retention (evapotranspiration and infiltration) of storm water volume.

- | | | |
|--------------------------|---|---|
| <input type="checkbox"/> | The biofiltration BMP is sited to allow for maximum infiltration of runoff volume based on the feasibility factors considered in site planning efforts. It is also designed to maximize evapotranspiration through the use of amended media and plants (biofiltration designs without amended media and plants may be permissible; see Item 5). | Document site planning and feasibility analyses in SWQMP per Section 5.4. |
|--------------------------|---|---|

Appendix F: Biofiltration Standard and Checklist

<input type="checkbox"/>	For biofiltration BMPs categorized as “Partial Infiltration Condition” the infiltration storage depth in the biofiltration design has been selected to drain in 36 hours (+/-25%) or an alternative value shown to maximize infiltration on the site.	Included documentation of estimated infiltration rate per Appendix D; provide calculations using Appendix B.4 and B.5 to show that the infiltration storage depth meets this criterion. Note, depths that are too shallow or too deep may not be acceptable.
<input type="checkbox"/>	For biofiltration BMP locations categorized as “Partial Infiltration Condition,” the infiltration storage is over the entire bottom of the biofiltration BMP footprint.	Document on plans that the infiltration storage covers the entire bottom of the BMP (i.e., not just underdrain trenches); or an equivalent footprint elsewhere on the site.
<input type="checkbox"/>	For biofiltration BMP locations categorized as “Partial Infiltration Condition,” the sizing factor used for the infiltration storage area is not less than the minimum biofiltration BMP sizing factors calculated using Worksheet B.5-1 to achieve 40% average annual percent capture within the BMP or downstream of the BMP. .	Provide a table that compares the minimum sizing factor per Appendix B.5 to the provided sizing factor. Note: The infiltration storage area could be a separate storage feature located downstream of the biofiltration BMP, not necessarily within the same footprint.
<input type="checkbox"/>	An impermeable liner or other hydraulic restriction layer is only used when needed to avoid geotechnical and/or subsurface contamination issues in locations identified as “No Infiltration Condition.”	If using an impermeable liner or hydraulic restriction layer, provide documentation of feasibility findings per Appendix C that recommend the use of this feature.
<input type="checkbox"/>	The use of “compact” biofiltration BMP design ² is permitted only in conditions identified as “No Infiltration Condition” and where site-specific documentation demonstrates that the use of larger footprint biofiltration BMPs would be infeasible.	Provide documentation of feasibility findings that recommend no infiltration is feasible. Provide site-specific information to demonstrate that a larger footprint biofiltration BMP would not be feasible.

² Compact biofiltration BMPs are defined as features with infiltration storage footprint less than the minimum sizing factors required to achieve 40% volume retention. Note that if a biofiltration BMP is accompanied by an infiltrating area downstream that has a footprint equal to at least the minimum sizing factors calculated using Worksheet B.5.1 assuming a partial infiltration condition, then it is not considered to be a compact biofiltration BMP for the purpose of Item 4 of the checklist. For potential configurations with a higher rate biofiltration BMP upstream of a larger footprint infiltration area, the BMP would still need to comply with Item 5 of this checklist for pollutant treatment effectiveness.

4. Biofiltration BMPs must be designed with a hydraulic loading rate to maximize pollutant retention, preserve pollutant control processes, and minimize potential for pollutant washout.

Intent: Various decisions about biofiltration BMP design influence the degree to which pollutants are retained. The MS4 Permit requires that biofiltration BMPs achieve maximum feasible retention of storm water pollutants.

<input type="checkbox"/>	<p>Media selected for the biofiltration BMP meets minimum quality and material specifications per 2016 City Storm Water Standards or County LID Manual, including the maximum allowable design filtration rate and minimum thickness of media.</p>	<p>Provide documentation that media meets the specifications in 2016 City Storm Water Standards or County LID Manual.</p>
OR		
<input type="checkbox"/>	<p>Alternatively, for proprietary designs and custom media mixes not meeting the media specifications contained in the 2016 City Storm Water Standards or County LID Manual, field scale testing data are provided to demonstrate that proposed media meets the pollutant treatment performance criteria in Section F.1 below.</p>	<p>Provide documentation of performance information as described in Section F.1.</p>
<input type="checkbox"/>	<p>To the extent practicable, filtration rates are outlet controlled (e.g., via an underdrain and orifice/weir) instead of controlled by the infiltration rate of the media.</p>	<p>Include outlet control in designs or provide documentation of why outlet control is not practicable.</p>
<input type="checkbox"/>	<p>The water surface drains to at least 12 inches below the media surface within 24 hours from the end of storm event flow to preserve plant health and promote healthy soil structure.</p>	<p>Include calculations to demonstrate that drawdown rate is adequate. Surface ponding drawdown time greater than 24-hours but less than 96 hours may be allowed at the discretion of the P&EAD and ADC if certified by a landscape architect or agronomist.</p>
<input type="checkbox"/>	<p>If nutrients are a pollutant of concern, design of the biofiltration BMP follows nutrient-sensitive design criteria.</p>	<p>Follow specifications for nutrient sensitive design in Fact Sheet BF-2. Or provide alternative documentation that nutrient treatment is addressed and potential for nutrient release is minimized.</p>

Appendix F: Biofiltration Standard and Checklist

<input type="checkbox"/>	Media gradation calculations or geotextile selection calculations demonstrate that migration of media between layers will be prevented, and permeability will be preserved.	Follow specification for choking layer or geotextile in Fact Sheet PR-1 or BF-1. Or include calculations to demonstrate that choking layer is appropriately specified.
<p>5. Biofiltration BMPs must be designed to promote appropriate biological activity to support and maintain treatment processes.</p> <p>Intent: Biological processes are an important element of biofiltration performance and longevity.</p>		
<input type="checkbox"/>	Plants have been selected to be tolerant of project climate, design ponding depths and the treatment media composition.	Provide documentation justifying plant selection. Refer to the plant list in Appendix E.23.
<input type="checkbox"/>	Plants have been selected to minimize irrigation requirements.	Provide documentation describing irrigation requirements for establishment and long-term operation.
<input type="checkbox"/>	Plant location and growth will not impede expected long-term media filtration rates and will enhance long term infiltration rates to the extent possible.	Provide documentation justifying plant selection. Refer to the plant list in Appendix E.23.
<input type="checkbox"/>	If plants are not part of the biofiltration design, other biological processes are supported as needed to sustain treatment processes (e.g., biofilm in a subsurface flow wetland).	For biofiltration designs without plants, describe the biological processes that will support effective treatment and how they will be sustained.
<p>6. Biofiltration BMPs must be designed with a hydraulic loading rate to prevent erosion, scour, and channeling within the BMP.</p> <p>Intent: Erosion, scour, and/or channeling can disrupt treatment processes and reduce biofiltration effectiveness.</p>		
<input type="checkbox"/>	Scour protection has been provided for both sheet flow and pipe inflows to the BMP, where needed.	Provide documentation of scour protection as described in Fact Sheets PR-1 or BF-1 or approved equivalent.
<input type="checkbox"/>	Where scour protection has not been provided, flows into and within the BMP are kept to non-erosive velocities.	Provide documentation of design checks for erosive velocities as described in Fact Sheets PR-1 or BF-1 or approved equivalent.

<input type="checkbox"/>	For proprietary BMPs, the BMP is used in a manner consistent with manufacturer guidelines and conditions of its third-party certification ³ (i.e., maximum tributary area, maximum inflow velocities, etc., as applicable).	Provide copy of manufacturer recommendations and conditions of third-party certification.
7. Biofiltration BMP must include operations and maintenance design features and planning considerations for continued effectiveness of pollutant and flow control functions.		
Intent: Biofiltration BMPs require regular maintenance in order provide ongoing function as intended. Additionally, it is not possible to foresee and avoid potential issues as part of design; therefore, plans must be in place to correct issues if they arise.		
<input type="checkbox"/>	The biofiltration BMP O&M plan describes specific inspection activities, regular/periodic maintenance activities and specific corrective actions relating to scour, erosion, channeling, media clogging, vegetation health, and inflow and outflow structures.	Include O&M plan with project submittal as described in Chapter 7.
<input type="checkbox"/>	Adequate site area and features have been provided for BMP inspection and maintenance access.	Illustrate maintenance access routes, setbacks, maintenance features as needed on project water quality plans.
<input type="checkbox"/>	For proprietary biofiltration BMPs, the BMP maintenance plan is consistent with manufacturer guidelines and conditions of its third-party certification (i.e., maintenance activities, frequencies).	Provide copy of manufacturer recommendations and conditions of third-party certification.

³ Certifications or verifications issued by the Washington Technology Acceptance Protocol-Ecology program and the New Jersey Corporation for Advanced Technology programs are typically accompanied by a set of guidelines regarding appropriate design and maintenance conditions that would be consistent with the certification/verification

F.1 Pollutant Treatment Performance Standard

Standard biofiltration BMPs that are designed following the criteria in Fact Sheets PR-1 and BF-1 are presumed to meet the pollutant treatment performance standard associated with biofiltration BMPs. This presumption is based on the MS4 Permit Fact Sheet which cites analyses of standard biofiltration BMPs conducted in the Ventura County Technical Guidance Manual (July 2011).

For BMPs that do not meet the biofiltration media specification and/or the range of acceptable media filtration rates described in Fact Sheet, PR-1 and BF-1, additional documentation must be provided to demonstrate that adequate pollutant treatment performance is provided to be considered a biofiltration BMP. Project applicants have three options for documenting compliance:

- 1) Project applicants may provide documentation to substantiate that the minor modification to the design is expected to provide equal or better pollutant removal performance for the project pollutants of concern than would be provided by a biofiltration design that complies with the criteria in Fact Sheets PR-1 and BF-1. Minor modifications are design elements that deviate only slightly from standard design criteria and are expected to either not impact performance or to improve performance compared to standard biofiltration designs. The reviewing agency has the discretion to accept or reject this documentation and/or request additional documentation to substantiate equivalent or better performance to BF-1 or PR-1, as applicable. Examples of minor deviations include:
 - (a) Different particle size distribution of aggregate, with documentation that system filtration rate will meet specifications.
 - (b) Alternative source of organic components, with documentation of material suitability and stability from appropriate testing agency.
 - (c) Specialized amendments to provide additional treatment mechanisms, and which have negligible potential to upset other treatment mechanisms or otherwise deteriorate performances.
- 2) For proprietary BMPs, project applicants may provide evidence that the BMP has been certified for use as part of the Washington State Technology Assessment Protocol-Ecology certification program and meets each of the following requirements:
 - (a) The applicant must demonstrate (using the checklist in this Appendix) that the BMP meets all other conditions to be considered as a biofiltration BMP. For example, a cartridge media filter or hydrodynamic separator would not meet biofiltration BMP design criteria regardless of Technology Acceptance Protocol-Ecology certification because they do not support effective biological processes.
 - (b) The applicant must select BMPs that have an active Technology Acceptance Protocol-Ecology certification, with General Use Level Designation for the appropriate project pollutants of concern as identified in Table F.1-1. The list of certified technologies is updated as new technologies are approved (link below). Technologies with Pilot Use Level Designation and Conditional Use Level Designations are not acceptable. Refer to: <http://www.ecy.wa.gov/programs/wq/stormwater/newtech/technologies.html>.

Appendix F: Biofiltration Standard and Checklist

- (c) The applicant must demonstrate that BMP is being used in a manner consistent with all conditions of the Technology Acceptance Protocol-Ecology certification while meeting the flow rate or volume design criteria that is required for biofiltration BMPs under this Manual. Conditions of Technology Acceptance Protocol-Ecology certification are available by clicking on the technology name at the website listed in bullet b. Additional discussion about sizing of proprietary biofiltration BMPs to comply with applicable sizing standards is provided below in Section F.2.
 - (d) For projects within the public right of way and/or capital projects: the product must be acceptable to the P&EAD and ADC with respect to maintainability and long-term operation of the product. In determining the acceptability of a product, the P&EAD and ADC should consider, as applicable, maintenance requirements, cost of maintenance activities, relevant previous local experience with operation and maintenance of the BMP type, ability to continue to operate the system in event that the vending company is no longer operating as a business, and other relevant factors. If a proposed BMP is not accepted by the P&EAD and/or ADC, a written explanation/reason will be provided to the applicant.
- 3) For BMPs that do not fall into options 1 or 2 above, the P&EAD and ADC may allow the applicant to submit alternative third-party documentation that the pollutant treatment performance of the system is consistent with the performance levels associated with the necessary Technology Acceptance Protocol-Ecology certifications. Table F.1-1 describes the required levels of certification and Table F.1-2 describes the pollutant treatment performance levels associated with each level of certification. Acceptance of this approach is at the sole discretion of the P&EAD and ADC. If a proposed BMP is not accepted by the P&EAD and/or ADC, a written explanation/reason will be provided to the applicant. If Technology Acceptance Protocol-Ecology certifications are not available, preference shall be given to:
- (a) Verified third-party, field-scale testing performance under the Technology Acceptance Reciprocity Partnership Tier II Protocol. This protocol is no longer operated; however, this is considered to be a valid protocol and historic verifications are considered to be representative provided that product models being proposed are consistent with those that were tested. Technology Acceptance Reciprocity Partnership verifications were conducted under New Jersey Corporation for Advance Testing and are archived at the website linked below. Note that Technology Acceptance Reciprocity Partnership verifications must be matched to pollutant treatment standards in Table F.1-2 then matched to an equivalent Technology Acceptance Protocol-Ecology certification in Table F.1-1.
 - (b) Verified third-party, field-scale testing performance under the New Jersey Corporation for Advance Testing protocol. Note that New Jersey Corporation for Advance Testing verifications must be matched to pollutant treatment standards in Table F.1-2 then matched to an equivalent Technology Acceptance Protocol-Ecology certification in Table F.1-1.
 - (c) A list of field-scale verified technologies under Technology Acceptance Reciprocity Partnership Tier II and New Jersey Corporation for Advance Testing can be accessed at: <http://www.njcat.org/verification-process/technology-verification-database.html> (refer to field verified technologies only).
-

Appendix F: Biofiltration Standard and Checklist

Table F.1-1. Required Technology Acceptance Protocol-Ecology Certifications for Pollutants of Concern for Biofiltration Performance Standard

Project Pollutant of Concern	Required Technology Acceptance Protocol-Ecology Certification for Biofiltration Performance Standard
Trash	Basic Treatment OR Phosphorus Treatment OR Enhanced Treatment
Sediments	Basic Treatment OR Phosphorus Treatment OR Enhanced Treatment
Oil and Grease	Basic Treatment OR Phosphorus Treatment OR Enhanced Treatment
Nutrients	Phosphorus Treatment ¹
Metals	Enhanced Treatment
Pesticides	Basic Treatment (including filtration) ² OR Phosphorus Treatment OR Enhanced Treatment
Organics	Basic Treatment (including filtration) ² OR Phosphorus Treatment OR Enhanced Treatment
Bacteria and Viruses	Basic Treatment (including bacteria removal processes) ³ OR Phosphorus Treatment OR Enhanced Treatment

Notes:

1. There is no Technology Acceptance Protocol-Ecology equivalent for nitrogen compounds; however, systems that are designed to retain phosphorus (as well as meet basic treatment designation), generally also provide treatment of nitrogen compounds. Where nitrogen is a pollutant of concern, relative performance of available certified systems for nitrogen removal should be considered in BMP selection.
2. Pesticides, organics, and oxygen demanding substances are typically addressed by particle filtration consistent with the level of treatment required to achieve Basic treatment certification; if a system with Basic treatment certification does not provide filtration, it is not acceptable for pesticides, organics or oxygen demanding substances.
3. There is no Technology Acceptance Protocol-Ecology equivalent for pathogens (viruses and bacteria), and testing data are limited because of typical sample hold times. Systems with Technology Acceptance Protocol-Ecology Basic Treatment must be included one or more significant bacteria removal process such as media filtration, physical sorption, predation, reduced redox conditions, and/or solar inactivation. Where design options are available to enhance pathogen removal (i.e., pathogen-specific media mix offered by vendor), this design variation should be used.

Appendix F: Biofiltration Standard and Checklist

Table F.1-2. Performance Standards for Technology Acceptance Protocol-Ecology Certification

Performance Goal	Influent Range	Criteria
Basic Treatment	20 – 100 mg/L TSS	Effluent goal \leq 20 mg/L TSS
	100 – 200 mg/L TSS	\geq 80% TSS removal
	>200 mg/L TSS	> 80% TSS removal, effluent not to exceed 100 mg/L TSS
Enhanced (Dissolved Metals) Treatment	Dissolved copper 0.005 – 0.02 mg/L	Must meet basic treatment goal and better than basic treatment currently defined as >30% dissolved copper removal
	Dissolved zinc 0.02 – 0.3 mg/L	Must meet basic treatment goal and better than basic treatment currently defined as >60% dissolved zinc removal
Phosphorous Treatment	Total phosphorous 0.1 – 0.5 mg/L	Must meet basic treatment goal and exhibit \geq 50% total phosphorous removal
Oil Treatment	Total petroleum hydrocarbon > 10 mg/L	No ongoing or recurring visible sheen in effluent Daily average effluent Total petroleum hydrocarbon concentration < 10 mg/L Maximum effluent Total petroleum hydrocarbon concentration for a 15 mg/L for a discrete (grab) sample
Pretreatment	50 – 100 mg/L TSS	\leq 50 mg/L TSS
	\geq 200 mg/L TSS	\geq 50% TSS removal

F.2 Guidance on Sizing and Design of Non-Standard Biofiltration BMPs

This section explains the general process for design and sizing of non-standard biofiltration BMPs. This section assumes that the BMPs have been selected based on the criteria in Section F.1.

F.2.1 Guidance on Design per Conditions of Certification/Verification

The biofiltration standard and checklist in this appendix requires that “the BMP is used in a manner consistent with manufacturer guidelines and conditions of its third-party certification.” Practically, what this means is that the BMP is used in the same way in which it was tested and certified. For example, it is not acceptable for a BMP of a given size to be certified/verified with a 100 gallon per minute treatment rate and be applied at a 150 gallon per minute treatment rate in a design.

Certifications or verifications issued by the Washington Technology Acceptance Protocol-Ecology program and the Technology Acceptance Reciprocity Partnership or New Jersey Corporation for Advance Testing programs are typically accompanied by a set of guidelines regarding appropriate design and maintenance conditions that would be consistent with the certification/verification. It is common for these approvals to specify the specific model of BMP, design capacity for given unit sizes, type of media that is the basis for approval, and/or another parameter. The applicant must demonstrate conclusively that the proposed application of the BMP is consistent with these criteria.

For alternate non-proprietary systems that do not have a Technology Acceptance Protocol-Ecology/Technology Acceptance Reciprocity Partnership/New Jersey Corporation for Advance Testing certification (but which still must provide quantitative data per Appendix F.1), it must be demonstrated that the configuration and design proposed for the project is reasonably consistent with the configuration and design under which the BMP was tested to demonstrate compliance with Appendix F.1.

F.2.2 Sizing of Flow-Based Biofiltration BMP

This sizing method is only available when the BMP meets the pollutant treatment performance standard in Appendix F.1.

Proprietary biofiltration BMPs are typically designed as a flow based BMPs (i.e., a constant treatment capacity with negligible storage volume). Proprietary biofiltration is only acceptable if the sizing criteria in this Appendix and the retention performance standard identified in Appendix B.5 are satisfied. The applicable sizing method for biofiltration is therefore reduced to: Treat 1.5 times the DCV.

The following steps should be followed to demonstrate that the system is sized to treat 1.5 times the DCV.

- 1) Calculate the flow rate required to meet the pollutant treatment performance standard without scaling for the 1.5 factor. Options include either:

Appendix F: Biofiltration Standard and Checklist

- (a) Calculate the runoff flow rate from a 0.2 inch per hour uniform intensity precipitation event (See methodology Appendix B.6.3), or
 - (b) Conduct a continuous simulation analysis to compute the size required to capture and treat 80 percent of average annual runoff; for small catchments, 5-minute precipitation data should be used to account for short time of concentration. Nearest rain gauge with 5-minute precipitation data is allowed for this analysis.
- 2) Multiply the flow rate from Step 1 by 1.5 to compute the design flow rate for the biofiltration system.
- 3) Based on the conditions of certification/verification (discussed above), establish the design capacity, as a flow rate, of a given sized unit.
- 4) Demonstrates that an appropriate unit size and number of units is provided to provide a flow rate that meets the required flow rate from Step 2.
- 5) Provide supplemental retention BMPs that will meet the volume retention performance standard in Appendix B.

Appendix

G

AUTHORITY BMP DESIGN MANUAL

**Guidance for Continuous
Simulation and Hydromodification
Management Sizing Factors**

February 2022

Appendix G Guidance for Continuous Simulation and Hydromodification Management Sizing Factors

G.1 Guidance for Continuous Simulation Hydrologic Modeling for Hydromodification Management Studies in San Diego County Region 9

G.1.1 Introduction

Continuous simulation hydrologic modeling is used to demonstrate compliance with the performance standards for hydromodification management in San Diego. **Although hydromodification management requirements do not apply at SAN, per Section 2 of this Manual, this Appendix is included as reference for the design of structural BMPs where appropriate and required, as noted throughout Appendix B.**

There are several available hydrologic models that can perform continuous simulation analyses. Each has different methods and parameters for determining the amount of rainfall that becomes runoff, and for representing the hydraulic operations of certain structural BMPs such as biofiltration with partial retention or biofiltration. This Appendix is intended to:

- Identify acceptable models for continuous simulation hydrologic analyses for hydromodification management;
- Provide guidance for selecting climatology input to the models;
- Provide standards for rainfall loss parameters to be used in the models;
- Provide standards for defining physical characteristics of LID components; and
- Provide guidance for demonstrating compliance with performance standards for hydromodification management.

This Appendix is not a user's manual for any of the acceptable models, nor a comprehensive manual for preparing a hydrologic model. This Appendix provides guidance for selecting model input parameters for the specific purpose of hydromodification management studies. The model preparer must be familiar with the user's manual for the selected software to determine how the parameters are entered to the model.

G.1.2 Software for Continuous Simulation Hydrologic Modeling

The following software models may be used for hydromodification management studies in San Diego:

- HSPF – Hydrologic Simulation Program-FORTRAN, distributed by USEPA, public domain.
- SDHM – San Diego Hydrology Model, distributed by Clear Creek Solutions, Inc. This is an HSPF-based model with a proprietary interface that has been customized for use in San Diego for hydromodification management studies.
- SWMM – Storm Water Management Model, distributed by USEPA, public domain.

Third-party and proprietary software, such as XPSWMM or PCSWMM, may be used for hydromodification management studies in San Diego, provided that:

- Input and output data from the software can interface with public domain software such as SWMM. In other words, input files from the third-party software should have sufficient functionality to allow export to public domain software for independent validation.
- The software's hydromodification control processes are substantiated.

G.1.3 Climatology Parameters

G.1.3.1 Rainfall

In all software applications for preparation of hydromodification management studies in San Diego, rainfall data must be selected from approved data sets that have been prepared for this purpose. As part of the development of the March 2011 Final HMP, long-term hourly rainfall records were prepared for public use. The rainfall record files are provided on the Project Clean Water website. The rainfall station map is provided in the March 2011 Final HMP and is included in this Appendix as Figure G.1-1.

Appendix G: Guidance for Continuous Simulation and Hydromodification Management Sizing Factors

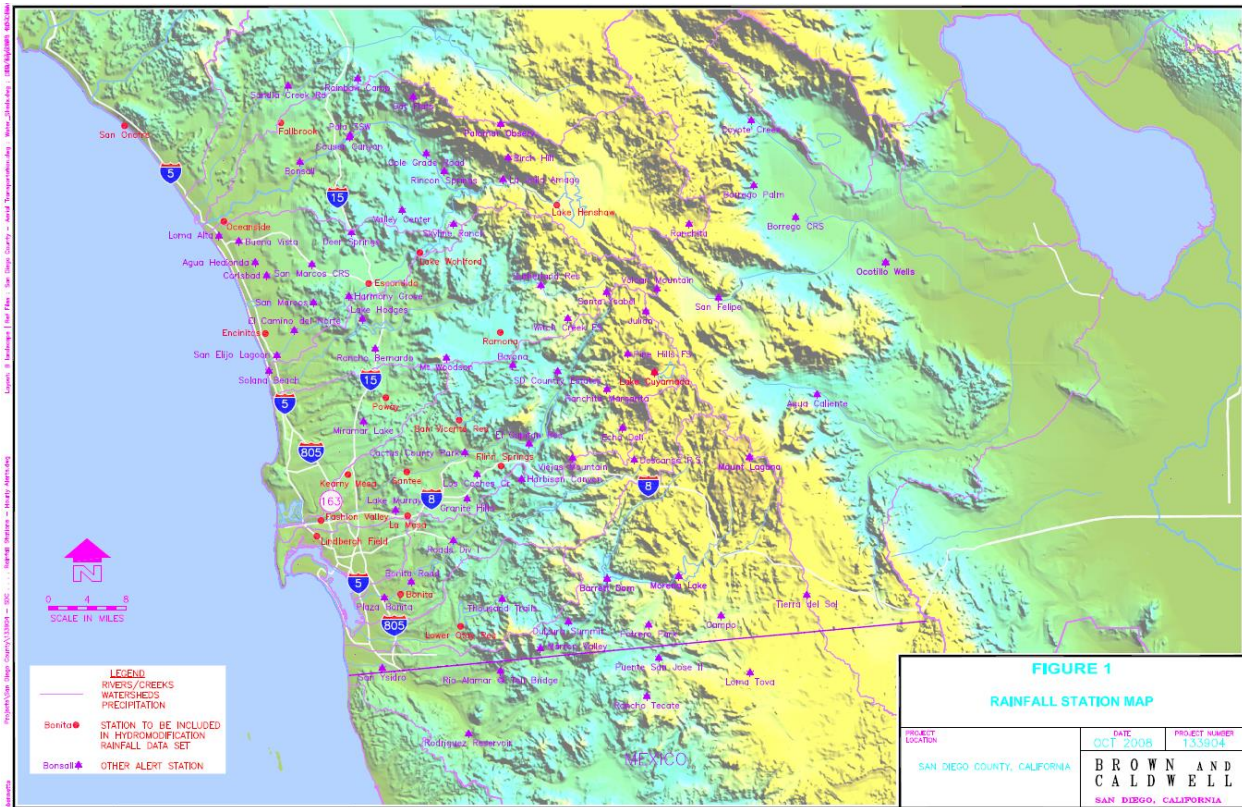

Figure G.1-1. Rainfall Station Map

Project applicants preparing continuous simulation models shall select the most appropriate rainfall data set from the rainfall record files provided on the Project Clean Water website. For a given project location, the following factors should be considered in the selection of the appropriate rainfall data set:

- In most cases, the rainfall data set in closest proximity to the project site will be the appropriate choice (refer to the rainfall station map).
- In some cases, the rainfall data set in closest proximity to the project site may not be the most applicable data set. Such a scenario could involve a data set with an elevation significantly different from the project site. In addition to a simple elevation comparison, the project proponent may also consult with the San Diego County’s average annual precipitation isopluvial map, which is provided in the San Diego County Hydrology Manual (2003). Review of this map could provide an initial estimate as to whether the project site is in a similar rainfall zone as compared to the rainfall stations. Generally, precipitation totals in San Diego County increase with increasing elevation.

Appendix G: Guidance for Continuous Simulation and Hydromodification Management Sizing Factors

- Where possible, rainfall data sets should be chosen so that the data set and the project location are both located in the same topographic zone (coastal, foothill, mountain) and major watershed unit (Upper San Luis Rey, Lower San Luis Rey, Upper San Diego River, Lower San Diego River, etc.).

For SDHM users, the approved rainfall data sets are pre-loaded into the software package. SDHM users may select the appropriate rainfall gauge within the SDHM program. HSPF, or SWMM users shall download the appropriate rainfall record from the Project Clean Water website and load it into the software program.

Both the pre-development and post-project model simulation period shall encompass the entire rainfall record provided in the approved rainfall data set. Scaling the rainfall data is not permitted.

G.1.3.2 Potential Evapotranspiration

Project applicants preparing continuous simulation models shall select a data set from the sources described below to represent potential evapotranspiration.

For HSPF users, this parameter may be entered as an hourly time series. The hourly time series that was used to develop the BMP Sizing Calculator parameters is provided on the project clean water website and may be used for hydromodification management studies in San Diego. For SDHM users, the hourly evaporation data set is pre-loaded into the program. HSPF users may download the evaporation record from the Project Clean Water website and load it into the software program.

For HSPF or SWMM users, this parameter may be entered as monthly values in inches per month or inches per day. Monthly values may be obtained from the California Irrigation Management Information System "Reference Evapotranspiration Zones" brochure and map (herein "CIMIS ETo Zone Map"), prepared by California Department of Water Resources, dated January 2012. The CIMIS ETo Zone Map is available from www.cimis.gov, and is provided in this Appendix as Figure G.1-2. Determine the appropriate reference evapotranspiration zone for the project from the CIMIS ETo Zone Map. The monthly average reference evapotranspiration values are provided below in Table G.1-1.

Appendix G: Guidance for Continuous Simulation and
Hydromodification Management Sizing Factors

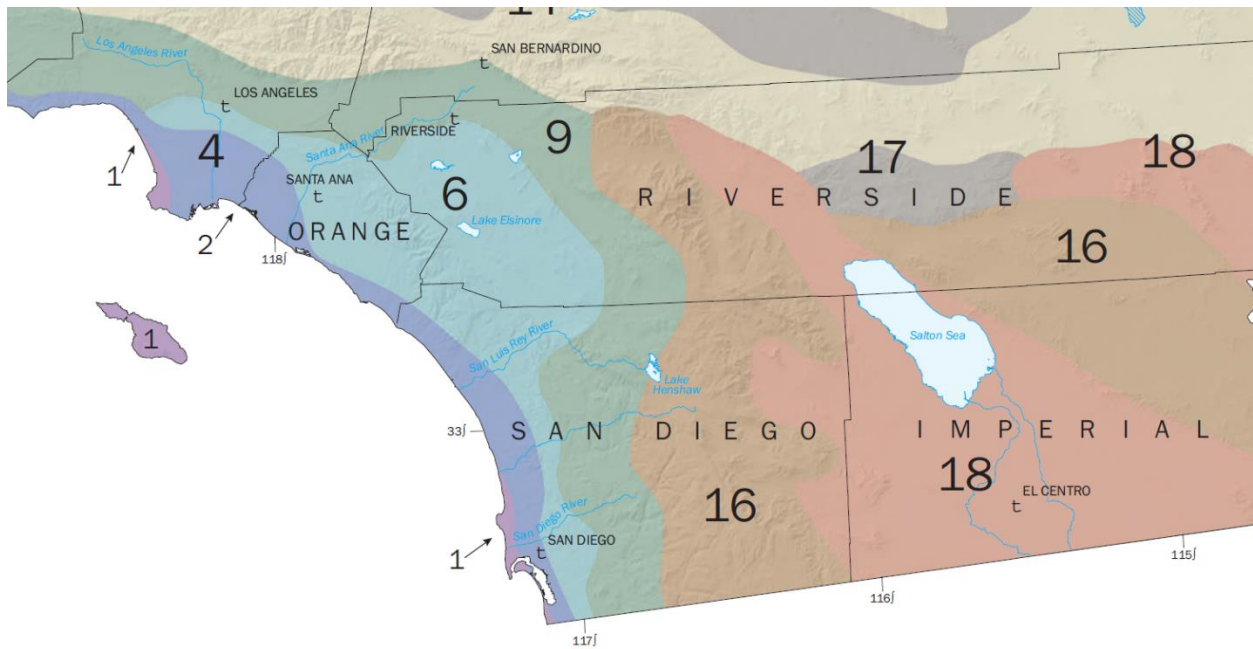

Figure G.1-2. California Irrigation Management Information System "Reference Evapotranspiration Zones"

Appendix G: Guidance for Continuous Simulation and Hydromodification Management Sizing Factors

Table G.1-1. Monthly Average Reference Evapotranspiration by ETo Zone (inches/month and inches/day) for use in SWMM Models for Hydromodification Management Studies in San Diego County CIMIS Zones 1, 4, 6, 9, and 16 (See CIMIS ETo Zone Map)

	January	February	March	April	May	June	July	August	September	October	November	December
Zone	in/month	in/month	in/month	in/month	in/month	in/month	in/month	in/month	in/month	in/month	in/month	in/month
1	0.93	1.4	2.48	3.3	4.03	4.5	4.65	4.03	3.3	2.48	1.2	0.62
4	1.86	2.24	3.41	4.5	5.27	5.7	5.89	5.58	4.5	3.41	2.4	1.86
6	1.86	2.24	3.41	4.8	5.58	6.3	6.51	6.2	4.8	3.72	2.4	1.86
9	2.17	2.8	4.03	5.1	5.89	6.6	7.44	6.82	5.7	4.03	2.7	1.86
16	1.55	2.52	4.03	5.7	7.75	8.7	9.3	8.37	6.3	4.34	2.4	1.55
Days	31	28	31	30	31	30	31	31	30	31	30	31
Zone	in/day	in/day	in/day	in/day	in/day	in/day	in/day	in/day	in/day	in/day	in/day	in/day
1	0.030	0.050	0.080	0.110	0.130	0.150	0.150	0.130	0.110	0.080	0.040	0.020
4	0.060	0.080	0.110	0.150	0.170	0.190	0.190	0.180	0.150	0.110	0.080	0.060
6	0.060	0.080	0.110	0.160	0.180	0.210	0.210	0.200	0.160	0.120	0.080	0.060
9	0.070	0.100	0.130	0.170	0.190	0.220	0.240	0.220	0.190	0.130	0.090	0.060
16	0.050	0.090	0.130	0.190	0.250	0.290	0.300	0.270	0.210	0.140	0.080	0.050

Appendix G: Guidance for Continuous Simulation and Hydromodification Management Sizing Factors

This page intentionally left blank

G.1.4 LAND CHARACTERISTICS AND LOSS PARAMETERS

In all software applications for preparation of hydromodification management studies in San Diego, rainfall loss parameters must be consistent with this Appendix unless the preparer can provide documentation to substantiate use of other parameters, subject to local jurisdiction approval. HSPF and SWMM use different processes and different sets of parameters. SDHM is based on HSPF, therefore parameters for SDHM and HSPF are presented together in Section G.1.4.1. Parameters that have been pre-loaded into SDHM may be used for other HSPF hydromodification management studies outside of SDHM. Parameters for SWMM are presented separately in Section G.1.4.2.

G.1.4.1 Rainfall Loss Parameters for HSPF and SDHM

Rainfall losses in HSPF are characterized by PERLND/PWATER parameters and IMPLND parameters, which describe processes occurring when rainfall lands on pervious lands and impervious lands, respectively. "BASINS Technical Notice 6, Estimating Hydrology and Hydraulic Parameters for HSPF," prepared by the USEPA, dated July 2000, provides details regarding these parameters and summary tables of possible ranges of these parameters. Table G.1-2, excerpted from the above-mentioned document, presents the ranges of these parameters.

For HSPF studies for hydromodification management in San Diego, PERLND/PWATER parameters and IMPLND parameters shall fall within the "possible" range provided in EPA Technical Note 6. To select specific parameters, HSPF users may use the parameters established for development of the San Diego BMP Sizing Calculator, and/or the parameters that have been established for SDHM. Parameters for the San Diego BMP Sizing Calculator and SDHM are based on research conducted specifically for HSPF modeling in San Diego.

Documentation of parameters selected for the San Diego BMP Sizing Calculator is presented in the document titled, San Diego BMP Sizing Calculator Methodology, prepared by Brown and Caldwell, dated January 2012 (herein "BMP Sizing Calculator Methodology"). The PERLND/PWATER parameters selected for development of the San Diego BMP Sizing Calculator represent a single composite pervious land cover that is representative of most pre-development conditions for sites that would commonly be managed by the BMP Sizing Calculator. The parameters shown below in Table G.1-3 are excerpted from the BMP Sizing Calculator Methodology.

Appendix G: Guidance for Continuous Simulation and
Hydromodification Management Sizing Factors

This page intentionally left blank

Appendix G: Guidance for Continuous Simulation and Hydromodification Management Sizing Factors

Table G.1-2. HSPF PERLND/PWATER and IMPLND Parameters from EPA Technical Note 6

Name	Definition	Units	Range of Values				Function of ...	Comment
			Typical		Possible			
			Min	Max	Min	Max		
PWAT – PARM2								
FOREST	Fraction forest cover	none	0.0	0.50	0.0	0.95	Forest cover	Only impact when SNOW is active
LZSN	Lower Zone Nominal Soil Moisture Storage	inches	3.0	8.0	2.0	15.0	Soils, climate	Calibration
INFILT	Index to Infiltration Capacity	inches/hour	0.01	0.25	0.001	0.50	Soils, land use	Calibration , divides surface and subsurface flow
LSUR	Length of overland flow	feet	200	500	100	700	Topography	Estimate from high resolution topo maps or GIS
SLSUR	Slope of overland flow plane	feet/foot	0.01	0.15	0.001	0.30	Topography	Estimate from high resolution topo maps or GIS
KVARY	Variable groundwater recession	1/inch	0.0	3.0	0.0	5.0	Baseflow recession variation	Used when recession rate varies with GW levels
AGWRC	Base groundwater recession	none	0.92	0.99	0.85	0.999	Baseflow recession	Calibration
PWAT – PARM3								
PETMAX	Temp below which ET is reduced	deg. F	35.0	45.0	32.0	48.0	Climate, vegetation	Reduces ET near freezing, when SNOW is active
PETMIN	Temp below which ET is set to zero	deg. F	30.0	35.0	30.0	40.0	Climate, vegetation	Reduces ET near freezing, when SNOW is active
INFEXP	Exponent in infiltration equation	none	2.0	2.0	1.0	3.0	Soils variability	Usually default to 2.0
INFILD	Ratio of max/mean infiltration capacities	none	2.0	2.0	1.0	3.0	Soils variability	Usually default to 2.0
DEEPR	Fraction of GW inflow to deep recharge	none	0.0	0.20	0.0	0.50	Geology, GW recharge	Accounts for subsurface losses
BASETP	Fraction of remaining ET from baseflow	none	0.0	0.05	0.0	0.20	Riparian vegetation	Direct ET from riparian vegetation
AGWETP	Fraction of remaining ET from active GW	none	0.0	0.05	0.0	0.20	Marsh/wetlands extent	Direct ET from shallow GW
PWAT – PARM4								
CEPSC	Interception storage capacity	inches	0.03	0.20	0.01	0.40	Vegetation type/density, land use	Monthly values usually used
UZSN	Upper zone nominal soil moisture storage	inches	0.10	1.0	0.05	2.0	Surface soil conditions, land use	Accounts for near surface retention
NSUR	Manning's n (roughness) for overland flow	none	0.15	0.35	0.05	0.50	Surface conditions, residue, etc.	Monthly values often used for croplands
INTFW	Interflow inflow parameter	none	1.0	3.0	1.0	10.0	Soils, topography, land use	Calibration , based on hydrograph separation
IRC	Interflow recession parameter	none	0.5	0.70	0.30	0.85	Soils, topography, land use	Often start with a value of 0.7, and then adjust
LZETP	Lower zone ET parameter	none	0.2	0.70	0.1	0.9	Vegetation type/density, root depth	Calibration
IWAT – PARM2								
LSUR	Length of overland flow	feet	50	150	50	250	Topography, drainage system	Estimate from maps, GIS, or field survey
SLSUR	Slope of overland flow plane	feet/foot	0.01	0.05	0.001	0.15	Topography, drainage	Estimate from maps, GIS, or field survey
NSUR	Manning's n (roughness) for overland flow	none	0.03	0.10	0.01	0.15	Impervious surface conditions	Typical range is 0.05 to 0.10 for roads/parking lots
RETSC	Retention storage capacity	inches	0.03	0.10	0.01	0.30	Impervious surface conditions	Typical range is 0.03 to 0.10 for roads/parking lots
IWAT – PARM3 (PETMAX and PETMIN, same values as shown for PWAT – PARM3)								

This page intentionally left blank

Appendix G: Guidance for Continuous Simulation and Hydromodification Management Sizing Factors

Table G.1-3. HSPF PERLND/PWATER Parameters from BMP Sizing Calculator Methodology

	Slope	Hydrologic Soil Group A			Hydrologic Soil Group B			Hydrologic Soil Group C			Hydrologic Soil Group D		
		5%	10%	15%	5%	10%	15%	5%	10%	15%	5%	10%	15%
PWAT_PAR M2	Jnits												
FOREST	None	0	0	0	0	0	0	0	0	0	0	0	0
LZSN	inches	5.2	4.8	4.5	5.0	4.7	4.4	4.8	4.5	4.2	4.8	4.5	4.2
INFILT	inches/hour	0.090	0.070	0.045	0.070	0.055	0.040	0.050	0.040	0.032	0.040	0.030	0.020
LSUR	feet	200	200	200	200	200	200	200	200	200	200	200	200
SLSUR	feet/foot	0.05	0.1	0.15	0.05	0.1	0.15	0.05	0.1	0.15	0.05	0.1	0.15
KVARY	inches	3	3	3	3	3	3	3	3	3	3	3	3
AGWRC	None	0.92	0.92	0.92	0.92	0.92	0.92	0.92	0.92	0.92	0.92	0.92	0.92
PWAT_PAR M3													
PETMAX (F)	F	35	35	35	35	35	35	35	35	35	35	35	35
PETMIN (F)	F	30	30	30	30	30	30	30	30	30	30	30	30
INFEXP	None	2	2	2	2	2	2	2	2	2	2	2	2
INFILD	None	2	2	2	2	2	2	2	2	2	2	2	2
DEEPR	None	0.4	0.4	0.4	0.4	0.4	0.4	0.4	0.4	0.4	0.4	0.4	0.4
BASETP	None	0.05	0.05	0.05	0.05	0.05	0.05	0.05	0.05	0.05	0.05	0.05	0.05
AGEWTP	None	0.05	0.05	0.05	0.05	0.05	0.05	0.05	0.05	0.05	0.05	0.05	0.05
PWAT_PAR M4													
CEPSC	inches	0.08	0.08	0.08	0.08	0.08	0.08	0.08	0.08	0.08	0.08	0.08	0.08
UZSN	inches	0.6	0.6	0.6	0.6	0.6	0.6	0.6	0.6	0.6	0.6	0.6	0.6
NSUR	None	0.2	0.2	0.2	0.2	0.2	0.2	0.2	0.2	0.2	0.2	0.2	0.2
INTFW	None	1.5	1.5	1.5	1.5	1.5	1.5	1.5	1.5	1.5	1.5	1.5	1.5
IRC	None	0.7	0.7	0.7	0.7	0.7	0.7	0.7	0.7	0.7	0.7	0.7	0.7
LZETP	None	0.5	0.5	0.5	0.5	0.5	0.5	0.5	0.5	0.5	0.5	0.5	0.5

Appendix G: Guidance for Continuous Simulation and Hydromodification Management Sizing Factors

Parameters within SDHM are documented in "San Diego Hydrology Model User Manual," prepared by Clear Creek Solutions, Inc. (as of the development of the Manual, the current version of the SDHM User Manual is dated January 2012). Parameters established for SDHM represent "grass" (non-turf grasslands), "dirt," "gravel," and "urban" cover. The documented PERLND and IMPLND parameters for the various land covers and soil types have been pre-loaded into SDHM. SDHM users shall use the parameters that have been pre-loaded into the program without modification unless the preparer can provide documentation to substantiate use of other parameters.

G.1.4.2 Rainfall Loss Parameters for SWMM

In SWMM, rainfall loss parameters (parameters that describe processes occurring when rainfall lands on pervious lands and impervious lands) are entered in the "subcatchment" module. In addition to specifying parameters, the SWMM user must also select an infiltration model.

The SWMM Manual provides details regarding the subcatchment parameters and summary tables of possible ranges of these parameters. For SWMM studies for hydromodification management in San Diego, subcatchment parameters shall fall within the range provided in the SWMM Manual. Some of the parameters depend on the selection of the infiltration model. For consistency across the San Diego region, SWMM users shall use the Green-Ampt infiltration model for hydromodification management studies. Table G.1-4 presents SWMM subcatchment parameters for use in hydromodification management studies in the San Diego region.

**Appendix G: Guidance for Continuous Simulation and
Hydromodification Management Sizing Factors**

**Table G.1-4. Subcatchment Parameters for SWMM Studies for Hydromodification Management in
San Diego**

SWMM Parameter Name	Unit	Range	Use in San Diego
Name X-Coordinate Y-Coordinate Description Tag Rain Gauge Outlet	N/A	N/A – project-specific	Project-specific
Area	acres (ac)	Project-specific	Project-specific
Width	feet (ft)	Project-specific	Project-specific
% Slope	percent (%)	Project-specific	Project-specific
% Imperv	percent (%)	Project-specific	Project-specific
N-imperv	--	0.011 – 0.024 presented in Table A.6 of SWMM Manual	default use 0.012 for smooth concrete, otherwise provide documentation of another surface consistent with Table A.6 of SWMM Manual
N-Perv	--	0.05 – 0.80 presented in Table A.6 of SWMM Manual	default use 0.15 for short prairie grass, otherwise provide documentation of another surface consistent with Table A.6 of SWMM Manual
Dstore-Imperv	inches	0.05 – 0.10 inch presented in Table A.5 of SWMM Manual	0.05
Dstore-Perv	inches	0.10 – 0.30 inch presented in Table A.5 of SWMM Manual	0.10
%ZeroImperv	percent (%)	0% – 100%	25%
Subarea routing	--	OUTLET IMPERVIOUS PERVIOUS	Project-specific, typically OUTLET
Percent Routed	%	0% – 100%	Project-specific, typically 100%
Infiltration	Method	HORTON GREEN_AMPT CURVE_NUMBER	GREEN_AMPT

**Appendix G: Guidance for Continuous Simulation and
Hydromodification Management Sizing Factors**

**Table G.1-4. Subcatchment Parameters for SWMM Studies for Hydromodification Management in
San Diego (continued)**

SWMM Parameter Name	Unit	Range	Use in San Diego
Suction Head (Green-Ampt)	Inches	1.93 – 12.60 presented in Table A.2 of SWMM Manual	Hydrologic Soil Group A: 1.5 Hydrologic Soil Group B: 3.0 Hydrologic Soil Group C: 6.0 Hydrologic Soil Group D: 9.0
Conductivity (Green-Ampt)	Inches per hour	0.01 – 4.74 presented in Table A.2 of SWMM Manual by soil texture class 0.00 – ≥ 0.45 presented in Table A.3 of SWMM Manual by hydrologic soil group	Hydrologic Soil Group A: 0.3 Hydrologic Soil Group B: 0.2 Hydrologic Soil Group C: 0.1 Hydrologic Soil Group D: 0.025 Note: reduce conductivity by 25% in the post-project condition when native soils will be compacted. Conductivity may also be reduced by 25% in the pre-development condition model for redevelopment areas that are currently concrete or asphalt but must be modeled according to their underlying soil characteristics. For fill soils in post-project condition, see Section G.1.4.3.
Initial Deficit (Green-Ampt)		The difference between soil porosity and initial moisture content. Based on the values provided in Table A.2 of SWMM Manual, the range for completely dry soil would be 0.097 to 0.375	Hydrologic Soil Group A: 0.30 Hydrologic Soil Group B: 0.31 Hydrologic Soil Group C: 0.32 Hydrologic Soil Group D: 0.33 Note: in long-term continuous simulation, this value is not important as the soil will reach equilibrium after a few storm events regardless of the initial moisture content specified.
Groundwater	yes/no	yes/no	NO
LID Controls			Project Specific
Snowpack Land Uses Initial Buildup Curb Length			Not applicable to hydromodification management studies

Appendix G: Guidance for Continuous Simulation and Hydromodification Management Sizing Factors

A schematic of the basic SWMM setup for hydromodification management studies is shown below, with the LID module is shown as a feature within the hydrology computational block. Surface water hydrology is distinguished from groundwater; however, the groundwater module is not typically used in hydromodification management studies.

The rainfall and climatology input time series data are used to generate surface runoff which in turn is hydraulically routed through the collection system and storage/treatment facilities. The figure includes the following terms in the water balance equation:

- P = Precipitation
- E/T = Evaporation/Transpiration
- I/S = Infiltration/Seepage
- Q = Runoff

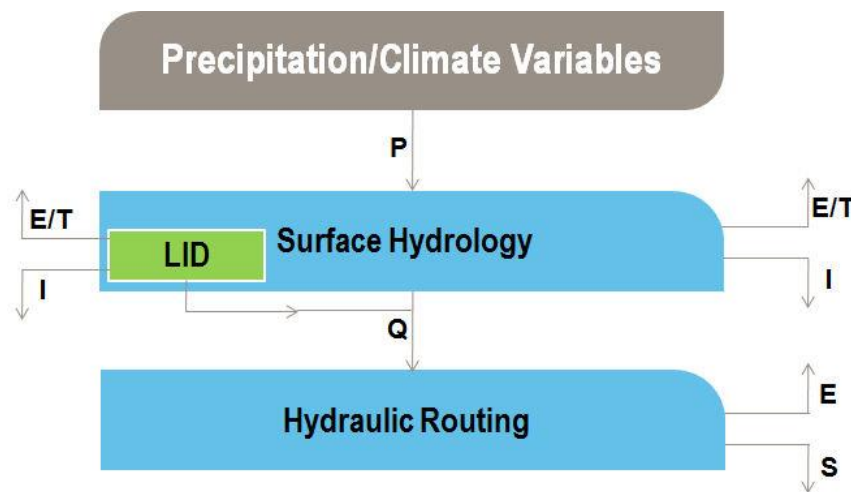

Evapotranspiration was previously addressed above; the remainder of this section discusses the other hydrologic losses and parameters.

Soil and Infiltration Parameters

Of the infiltration options available in SWMM, the Green-Ampt equation can best handle variable water content conditions in the shallow soil layers beneath the ground surface, which is critical for long-term continuous simulation of surface water hydrology. The Green-Ampt parameters suggested in Table G.1-4 are referenced according to hydrologic soil group. Green-Ampt parameters can also be determined by relating infiltration parameters to soil texture properties, as identified by in-situ geotechnical analysis results or published County soil survey information. Infiltration parameters include:

- Capillary Tension (Suction Head): a measure of how tightly water is held within the soil pore space;

Appendix G: Guidance for Continuous Simulation and Hydromodification Management Sizing Factors

- Saturated Hydraulic Conductivity: a measure of how quickly the water can be drained vertically; and
- Initial Moisture Deficit: a measure of the initial soil water deficit, also known as porosity (i.e., the volumetric fraction of water within the soil pore space under initially dry conditions).

Note that when SWMM is used without the Groundwater module, there is no distinction between the upper and lower zone soil moisture storage as in HSPF/SDHM. The LID module does however distinguish several layers/zones within each facility, and these are described below.

Overland Flow Parameters

Overland flow parameters describe the slope and length characteristics of shallow surface runoff. These are determined by identifying representative overland flow paths for each subcatchment using available digital topographic data for pre-development conditions and the proposed grading plan for post-project conditions. Overland flow path lengths and slopes are measured directly from the available information. Generally, overland flow paths should be less than 1,000 feet in length, otherwise channelized flow is likely present and should be modeled hydraulically. Overland flow path widths are determined based on the subcatchment area divided by the corresponding flow path length for each subcatchment.

Although Surface Storage is not depicted in SWMM schematic, it is a component of the water balance equation and includes excess runoff that is held in both hydrologic depression storage and hydraulic storage units.

LID Module

There are two approaches for representing LID facilities in SWMM:

- **Modeling Approach No. 1:** Place LID controls within the appropriate subcatchment and then adjust parameters accordingly to reflect untreated areas within the parent subcatchment; and
- **Modeling Approach No. 2:** Create a new subcatchment for each LID control, allowing “run-on” from the treated portion of the parent subcatchment.

Modeling Approach No.1 schematic is presented below. As described above, a portion of the impervious subarea from a given subcatchment can be routed onto the pervious area for infiltration (see arrow denoting subarea routing fraction). When the LID module of SWMM is used, the portion of the impervious area that is captured and treated by an LID facility is specified (see arrow denoting LID area fraction). The remaining impervious area, if any, is routed directly to the outlet.

Appendix G: Guidance for Continuous Simulation and Hydromodification Management Sizing Factors

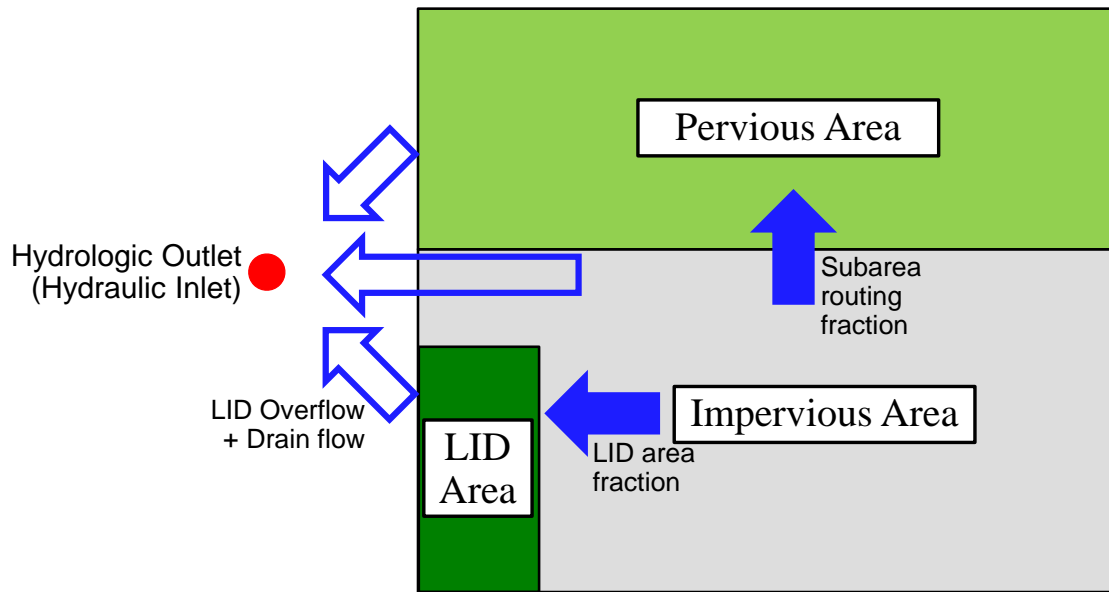

Modeling Approach No. 1 (LID within Parent Subcatchment)

The first approach is the easiest of the two for representing LID facilities in SWMM, as it allows a mix of controls to be placed within an existing subcatchment and each facility can capture and treat a different portion of the runoff generated from the parent subcatchment (i.e., outside of the LID footprint). A drawback of this approach is that it will not appropriately represent LID facilities in series (i.e., where the outflow from one LID control becomes the inflow to another LID control). No adjustments to the parent subcatchment hydrology parameters are needed if the cumulative LID area is small in comparison to the subcatchment area. However, when the cumulative LID area is significant (e.g., greater than 10 percent of the subcatchment), at a minimum, the imperviousness and overland flow width values will need to be adjusted to compensate for the parent subcatchment area that was replaced with the cumulative LID footprint area.

Modeling Approach No.2 schematic is presented below. In this approach the LID facility is assigned to a new subcatchment and runoff from upstream subcatchments can be directed to this new subcatchment (i.e., “run-on”). In this way, LID controls can be modeled in series. Adjustments to the imperviousness and overland flow width values in the parent subcatchment will need to be made. For typical development or redevelopment sites that are evaluated in hydromodification management studies, LID capture areas often comprise a large portion of the parent subcatchments, and therefore this is the preferred approach.

Appendix G: Guidance for Continuous Simulation and Hydromodification Management Sizing Factors

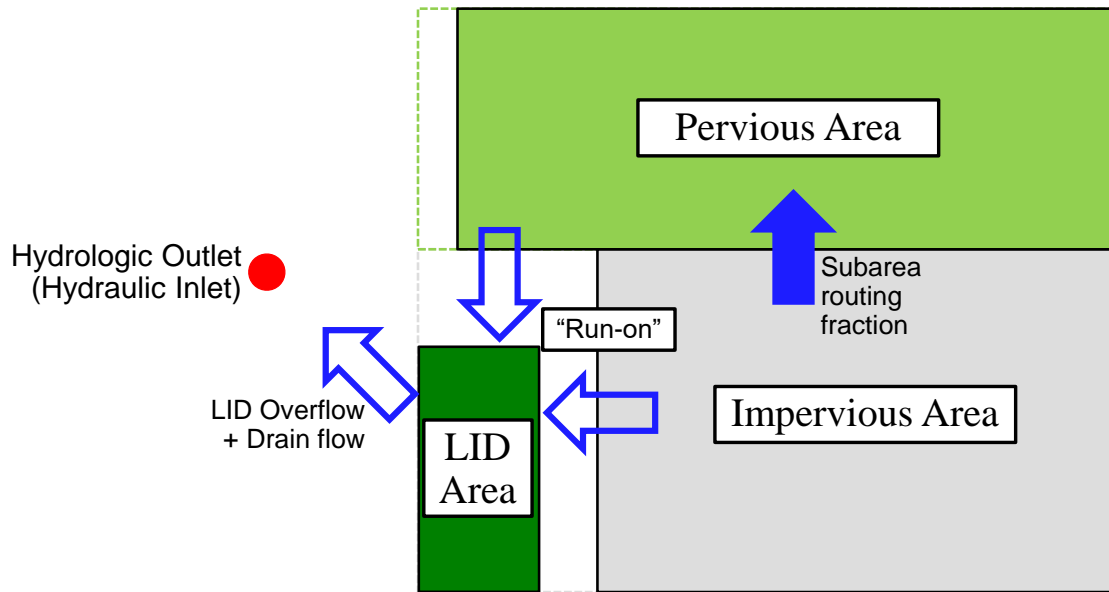

Modeling Approach No. 2 (LID in New Subcatchment)

More details on the use and application of LID controls are provided in the SWMM Manual and program help file. Suggested parameter values for use with hydromodification management studies in San Diego are provided in Appendix G.1.5.

G.1.4.3 Pervious Area Rainfall Loss Parameters in Post-Project Condition (HSPF, SDHM, and SWMM)

The following guidance applies to HSPF, SDHM, and SWMM. When modeling pervious areas in the post-project condition, fill soils shall be modeled as hydrologic soil group Type D soils, or the project applicant may provide an actual expected infiltration rate for the fill soil based on testing (must be approved by the ADC and P&EAD for use in the model). Where landscaped areas on fill soils will be re-tilled and/or amended in the post-project condition, the landscaped areas may be modeled as Type C soils. Areas to be re-tilled and/or amended in the post-project condition must be shown on the project plans. For undisturbed pervious areas (i.e., native soils, no fill), use the actual hydrologic soil group, the same as in the pre-development condition.

G.1.5 MODELING STRUCTURAL BMPs (PONDS AND LID FEATURES)

There are many ways to model structural BMPs. There are standard modules for several pond or LID elements included in SDHM and SWMM. Users may also set up project-specific stage-storage-discharge relationships representing structural BMPs. Regardless of the modeling method, certain characteristics of the structural BMP, including infiltration of water from the bottom of the structural BMP into native soils, porosity of bioretention soils and/or gravel sublayers, and other program-specific parameters must be consistent with those presented below, unless the preparer can provide documentation to substantiate use of other parameters, subject to local jurisdiction approval. The geometry of structural BMPs is project-specific and shall match the project plans.

Appendix G: Guidance for Continuous Simulation and Hydromodification Management Sizing Factors

G.1.5.1 Infiltration into Native Soils Below Structural BMPs

Infiltration into native soils below structural BMPs may be modeled as a constant outflow rate equal to the project site-specific design infiltration rate (Worksheet D.5-1) multiplied by the area of the infiltrating surface (and converted to ft³ per second). This infiltration rate is not the same as an infiltration parameter used in the calculation of rainfall losses, such as the HSPF INFILT parameter or the Green-Ampt conductivity parameter in the SWMM subcatchment module. It must be site-specific and must be determined based on the methods presented in Appendix D of this Manual.

For preliminary analysis when site-specific geotechnical investigation has not been completed, project applicants proposing infiltration into native soils as part of the structural BMP design shall prepare a sensitivity analysis to determine a potential range for the structural BMP size based on a range of potential infiltration rates. As shown in Appendices C and D of this Manual, many factors influence the ability to infiltrate storm water. Therefore, even when soil types A and B are present, which are generally expected to infiltrate storm water, the possibility that a very low infiltration rate could be determined at design level must be considered. The range of potential infiltration rates for preliminary analysis is shown below in Table G.1-5.

Table G.1-5. Range of Potential Infiltration Rates to be Studied for Sensitivity Analysis when Native Infiltration is Proposed but Site-Specific Geotechnical Investigation has not been Completed

Hydrologic Soil Group at Location of Proposed Structural BMP	Low Infiltration Rate for Preliminary Study (inches/hour)	High Infiltration Rate for Preliminary Study (inches/hour)
A	0.02	2.4
B	0.02	0.52
C	0	0.08
D	0	0.02

The infiltration rates shown above are for preliminary investigation only. Final design of a structural BMP must be based on the project site-specific design infiltration rate (Worksheet D.5-1).

G.1.5.2 Structural BMPs That Do Not Include Sub-Layers (Ponds)

To model a pond, basin, or other depressed area that does not include processing runoff through sublayers of amended soil and/or gravel, create a stage storage discharge relationship for the pond, and supply the information to the model according to the program requirements. For HSPF users, the stage-storage-discharge relationship is provided in FTABLES. SDHM users may use the TRAPEZOIDAL POND element for a trapezoidal pond or IRREGULAR POND element to request the program to create the stage-storage-discharge relationship, use the SSD TABLE element to supply a user-created stage-storage-discharge relationship, or use other available modules such as TANK or VAULT. For SWMM users, the stage-storage relationship is supplied in the storage unit module, and the stage-discharge relationship may be represented by various other modules such as the orifice, weir, or outlet modules. Stage-storage and stage-discharge curves for structural BMPs must be fully

Appendix G: Guidance for Continuous Simulation and Hydromodification Management Sizing Factors

documented in the project-specific HMP report and must be consistent with the structural BMP(s) shown on project plans.

For user-created stage-discharge relationships, refer to local drainage manual criteria for equations representing hydraulic behavior of outlet structures. Users relying on the software to develop the stage-discharge relationship may use the equations built into the program. This Manual does not recommend that all program modules calculating stage-discharge relationships must be uniform because the flows to be controlled for hydromodification management are low flows, calculated differently from the single-storm event peak flows studied for flood control purposes, and hydromodification management performance standards do not represent any performance standard for flood control drainage design. Note that for design of emergency outlet structures, and any calculations related to single-storm event routing for flood control drainage design, stage-discharge calculations must be consistent with the local drainage design requirements. This may require separate calculations for stage-discharge relationship pursuant to local manuals. The HMP flow rates shall not be used for flood control calculations.

G.1.5.3 Structural BMPs That Include Sub-Layers (Bioretention and Other LID)

G.1.5.3.1 Characteristics of Engineered Soil Media

The engineered soil media used in bioretention, biofiltration with partial retention, and biofiltration structural BMPs is a sandy loam. The following parameters presented in Table G.1-6 are characteristics of a sandy loam for use in continuous simulation models.

Table G.1-6. Characteristics of Sandy Loam to Represent Engineered Soil Media in Continuous Simulation for Hydromodification Management Studies in San Diego

Soil Texture	Porosity	Field Capacity	Wilting Point	Conductivity	Suction Head
Sandy Loam	0.4	0.2	0.1	5 inches/hour	1.5 inches

- Porosity is the volume of pore space (voids) relative to the total volume of soil (as a fraction).
- Field Capacity is the volume of pore water relative to total volume after the soil has been allowed to drain fully (as a fraction). Below this level, vertical drainage of water through the soil layer does not occur.
- Wilting point is the volume of pore water relative to total volume for a well dried soil where only bound water remains (as a fraction). The moisture content of the soil cannot fall below this limit.
- Conductivity is the hydraulic conductivity for the fully saturated soil (inches/hour or millimeters per hour).
- Suction head is the average value of soil capillary suction along the wetting front (inches or millimeters).

Figures G.1-3 and G.1-4, from <http://www.stevenswater.com/articles/irrigationscheduling.aspx>, illustrate unsaturated soil and soil saturation, field capacity, and wilting point.

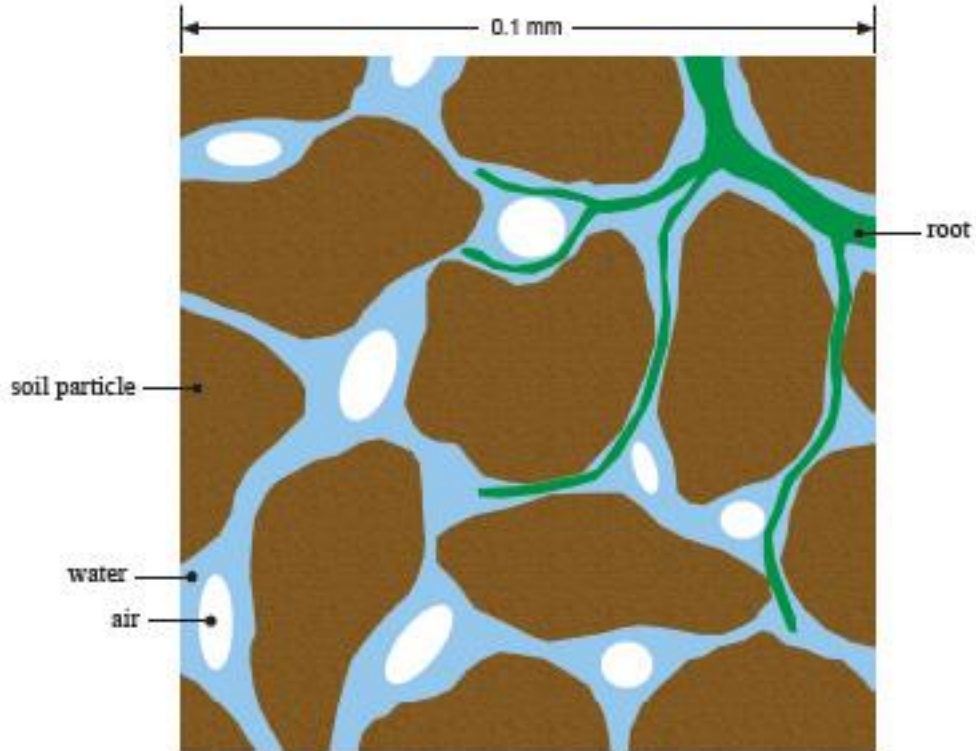

Figure G.1-3. Unsaturated Soil Composition

Unsaturated Soil Is Composed of Solid Particles, Organic Material and Pores. The Pore Space Will Contain Air And Water

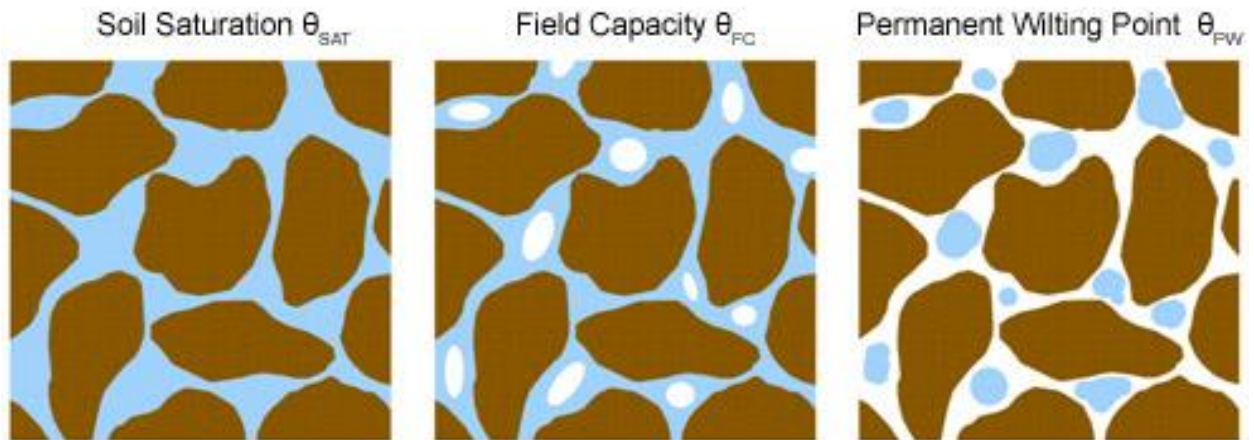

Figure G.1-4. Soil Saturation, Field Capacity, and Wilting Point

Appendix G: Guidance for Continuous Simulation and Hydromodification Management Sizing Factors

G.1.5.3.2 Characteristics of Gravel

For the purpose of hydromodification management studies, it may be assumed that water moves freely through gravel, not limited by hydraulic properties of the gravel. For the purpose of calculating available volume, use porosity of 0.4, or void ratio of 0.67. Porosity is equal to void ratio divided by (1 + void ratio).

G.1.5.3.3 Additional Guidance for SDHM Users

The module titled "bioretention/rain garden element" may be used to represent bioretention or biofiltration BMPs. SDHM users using the available "bioretention/rain garden element" shall customize the soil media characteristics to use the parameters from Table G.1-6 above and select "gravel" for gravel sublayers. All other input variables are project specific. "Native infiltration" refers to infiltration from the bottom of the structural BMP into the native soil. This variable is project-specific, see Section G.1.5.1.

G.1.5.3.4 Additional Guidance for SWMM Users

The latest version of SWMM (version 5.1.012) includes the following eight types of LID controls:

- Bio-Retention Cell: surface storage facility with vegetation in a bioretention soil mixture placed above a gravel drainage bed.
- Rain Garden: same setup as bio-retention cell, but without an underlying gravel bed.
- Green Roof: bio-retention cell with shallow surface storage and soil layers, underlain by a drainage mat that conveys excess percolated rainfall to the regular roof drainage system.
- Infiltration Trench: drainage swale or narrow storage basin filled with gravel or other porous media designed to capture and infiltrate runoff to the native soil below.
- Permeable Pavement: continuous pavement systems with porous concrete, asphalt mix, or paver blocks above a sand or gravel drainage bed with gravel storage layer below.
- Rain Barrel: container (cistern) to collect roof runoff for later use (e.g., landscape irrigation) or release.
- Rooftop Disconnection: to simulate redirection of downspout discharge onto pervious landscaped areas and lawns instead of directly into storm drains.
- Vegetative Swale: grassed conveyance channel (drainage ditch or swale) with vegetation designed to slow down runoff to allow more time for infiltration into the native soil below.

The "bio-retention cell" LID control may be used to represent bioretention or biofiltration BMPs. For bio-retention cells, a number of LID process layers have been defined in SWMM and these are described below. Table G.1-7 provides parameters required for the standard "bio-retention cell" available in SWMM. The parameters are entered in the LID Control Editor.

**Appendix G: Guidance for Continuous Simulation and
Hydromodification Management Sizing Factors**

**Table G.1-7. Parameters for SWMM "Bio-Retention Cell" Module for Hydromodification
Management Studies in San Diego**

SWMM Parameter Name	Unit	Use in San Diego
<i>Surface</i>		
Berm Height also known as Storage Depth	inches	Project-specific
Vegetative Volume Fraction also known as Vegetative Cover Fraction	---	0
Surface Roughness	---	0 (this parameter is not applicable to bio-retention cell)
Surface Slope	---	0 (this parameter is not applicable to bio-retention cell)
<i>Soil</i>		
Thickness	inches	project-specific
Porosity	---	0.40
Field Capacity	---	0.2
Wilting Point	---	0.1
Conductivity	Inches/hour	5
Conductivity Slope	---	5
Suction Head	inches	1.5
<i>Storage</i>		
Thickness also known as Height	inches	Project-specific
Void Ratio	---	0.67
Seepage Rate also known as Conductivity	Inches/hour	Conductivity from the storage layer refers to infiltration from the bottom of the structural BMP into the native soil. This variable is project-specific, see Section G.5.1. Use 0 if the bio-retention cell includes an impermeable liner
Clogging Factor	---	0
<i>Underdrain</i>		
Flow Coefficient Also known as Drain Coefficient	---	Project-specific
Flow Exponent Also known as Drain Exponent	---	Project-specific, typically 0.5
Offset Height Also known as Drain Offset Height	Inches	Project-specific

Appendix G: Guidance for Continuous Simulation and Hydromodification Management Sizing Factors

Surface Layer

This process layer receives direct rainfall (and run-on from upstream subcatchments) and the resultant storm water is available for ponding, infiltration, evapotranspiration, or overflow to the outlet. The following parameters are used:

- **Berm Height:** This value is the maximum depth that water can pond above the ground surface before overflow occurs. In some cases, this volume may overlap with the hydraulic representation of existing surface storage or another proposed BMP facility. In any case, the user must avoid double counting the physical storage volume.
- **Vegetation Volume Fraction:** This represents the surface storage volume that is occupied by the stems and leaves of vegetation within the bio-retention cell.

Soil Layer

This process layer is typically composed of an amended soil or compost mix. Water that infiltrates into this component is stored in the soil void space and is available for evapotranspiration via plant roots or can percolate into the storage layer below. The following parameters are used:

- **Thickness:** This parameter represents the depth of the amended soil layer.
- **Porosity:** Ratio of pore space volume to soil volume.
- **Field Capacity:** Pore water volume ratio after the soil has been drained.
- **Wilting Point:** Pore water volume ratio after the soil has been dried.
- **Conductivity:** This represents the saturated hydraulic conductivity.
- **Conductivity Slope:** Rate at which conductivity decreases with decreasing soil moisture content.
- **Suction Head:** This represents the capillary tension of water in the soil.

Porosity, conductivity and suction head values as a function of soil texture were included in Table G.1-5. The flow of water through partially saturated soil is less than under fully saturated conditions. The SWMM program accounts for this reduced hydraulic conductivity to predict the rate at which infiltrated water moves through a layer of unsaturated soil when modeling groundwater or LID controls. The conductivity slope is a dimensionless curve-fitting parameter that relates the partially saturated hydraulic conductivity to the soil moisture content.

Storage Layer

This process layer is typically composed of porous granular media such as crushed stone or gravel. Water that percolates into this component is stored in the void space and is available for infiltration into the native soil or collected by an underdrain and discharged to the outlet. The following parameters are used:

- **Thickness:** This parameter represents the depth of the stone base.

Appendix G: Guidance for Continuous Simulation and Hydromodification Management Sizing Factors

- Void Ratio: Volume of void space relative to volume of solids. Note, by definition, Porosity = Void Ratio ÷ (1 + Void Ratio).
- Seepage Rate: Filtration rate from the granular media into the native soil below. A value of zero should be used if the facility has an impermeable bottom (e.g., concrete) or is underlain by an impermeable liner.
- Clogging Factor: This value is determined by the total volume of treated runoff to completely clog the bottom of the layer divided by the void volume of the layer.

Drain Layer

This process layer is used to characterize the discharge rate of an underdrain system to the outlet. The following parameters are used:

Flow Coefficient: This value (coupled with the flow exponent described below) characterizes the rate of discharge to the outlet as a function of the height of water stored in the bio-retention cell. The coefficient can be determined by the following equation:

$$C = c_g \left(\frac{605}{A_{LID}} \right) \left(\frac{\pi D^2}{8} \right) \sqrt{\frac{g}{6}}$$

where

c_g is the orifice discharge coefficient, typically 0.60-0.65 for thin-walled plates and higher for thicker walls;

A_{LID} is the cumulative footprint area (ft²) of all LID controls;

D is the underdrain orifice diameter (in); and

g is the gravitational constant (32.2 ft/s²).

Flow Exponent: A value of 0.5 should be used to represent flow through an orifice.

Offset Height: This represents the height of the underdrain above the bottom of the storage layer in the bio-retention cell.

G.1.6 FLOW FREQUENCY AND DURATION

The continuous simulation model will generate a flow record corresponding to the frequency of the rainfall data input as its output. This flow record must then be processed to determine pre-development and post-project flow rates and durations. Compliance with hydromodification management requirements of this Manual is achieved when results for flow duration meet the performance standards.

Appendix G: Guidance for Continuous Simulation and Hydromodification Management Sizing Factors

The performance standard is as follows (also presented in Chapter 6 of this Manual):

- 1) For flow rates ranging from 10 percent, 30 percent or 50 percent of the pre-development 2-year runoff event ($0.1Q_2$, $0.3Q_2$, or $0.5Q_2$) to the pre-development 10-year runoff event (Q_{10}), the post-project discharge rates and durations must not exceed the pre-development rates and durations by more than 10 percent. The specific lower flow threshold will depend on the erosion susceptibility of the receiving stream for the project site (see Section 6.3.4).

To demonstrate that a flow control facility meets the hydromodification management performance standard, first pre-development Q_2 and Q_{10} must be identified, then a flow duration summary must be generated and compared for pre-development and post-project conditions between the appropriate fraction of Q_2 to Q_{10} . The range from a fraction of Q_2 to Q_{10} represents the range of geomorphically significant flows for hydromodification management in San Diego. The upper bound of the range of flows to control is pre-development Q_{10} for all projects. The lower bound of the range of flows to control, or "lower flow threshold" is a fraction of pre-development Q_2 that is based on the erosion susceptibility of the stream and depends on the specific natural system (stream) that a project will discharge to. Tools have been developed in the March 2011 Final HMP for assessing the erosion susceptibility of the stream (see Section 6.3.4). Simply multiply the pre-development Q_2 by the appropriate fraction (e.g., $0.1Q_2$) to determine the lower flow threshold.

The following guidelines shall be used for determining flow rates and durations.

G.1.6.1 Determining Flow Rates from Continuous Hourly Flow Output

In the context of hydromodification management in San Diego, Q_2 and Q_{10} refer to flow rates determined based on either continuous simulation hydrologic modeling or an approved regression equation. Either method may be applied, provided that the same methodology is applied to determination of both Q_2 and Q_{10} (i.e., cannot mix and match methods at a POC) and be consistent across all POCs for the project (i.e., cannot mix and match methods between multiple POCs).

G.1.6.1.1 Determining Flow Rates from Regression Equation

The following approved regression equation may be used to determine pre-development Q_2 and Q_{10} :

$$Q_2 = 3.60 \times A^{0.672} \times P^{0.753}$$

$$Q_{10} = 6.56 \times A^{0.783} \times P^{1.07}$$

where:

Q_2	=	2-year recurrence interval discharge in ft^3 per second
Q_{10}	=	10-year recurrence interval discharge in ft^3 per second
A	=	Drainage area in square miles
P	=	Mean annual precipitation in inches (Refer to Table G.1-8)

Appendix G: Guidance for Continuous Simulation and Hydromodification Management Sizing Factors

Table G.1-8 Error! No text of specified style in document. **8. Mean Annual Precipitation**

Gauge	Latitude	Longitude	Mean Annual Precipitation (inches)
Oceanside	33.2105556	-117.353333	12.29
Encinitas	33.044567	-117.277213	10.73
Kearney Mesa	32.835118	-117.128456	11.43
Fashion Valley	32.7652778	-117.1758333	10.75
Bonita	32.6561111	-117.0341667	10.88
Poway	32.9522222	-117.0472222	13.08
Fallbrook AP	33.354669	-117.251279	16.18
Lake Wohlford	33.166423	-117.004955	16.63
Ramona	33.0480556	-116.8608333	16.57
Lake Henshaw	33.2386111	-116.7616667	21.58
Borrego	33.2211111	-116.3369444	4.00
Lindbergh	32.7337	-117.1767	10.75
Escondido	33.1197222	-117.095	14.67
Flinn Springs	32.847104	-116.857801	15.55
Lake Cuyamaca	32.9894	-116.5867	31.30
Lower Otay	32.6111	-116.9319	11.90
San Onofre	33.3513889	-117.5319444	11.13
San Vicente	32.912082	-116.926513	16.47
Santee	32.839016	-117.024857	13.15

G.1.6.1.2 Determining Flow Rates from Continuous Hourly Flow Output

Flow rates for hydromodification management studies in San Diego must be based on partial duration series analysis of the continuous hourly flow output. Partial duration series frequency calculations consider multiple storm events in a given year.

Appendix G: Guidance for Continuous Simulation and Hydromodification Management Sizing Factors

To construct the partial duration series:

- 1) Parse the continuous hourly flow data into discrete runoff events. The following separation criteria may be used for separation of flow events: a new discrete event is designated when the flow falls below an artificially low flow value based on a fraction of the contributing watershed area (e.g., 0.002 to 0.005 cfs/acre) for a time period of 24 hours. Project applicants may consider other separation criteria provided the separation interval is not more than 24 hours and the criteria is clearly described in the submittal document.
- 2) Rank the peak flows from each discrete flow event and compute the return interval or plotting position for each event.

Readers who are unfamiliar with how to compute the partial-duration series should consult reference books or online resources for additional information. For example, Hydrology for Engineers, by Linsley et al., 1982, discusses partial-duration series on pages 373-374 and computing recurrence intervals or plotting positions on page 359. Handbook of Applied Hydrology, by Chow, 1964, contains a detailed discussion of flow frequency analysis, including Annual Exceedance, Partial-Duration and Extreme Value series methods, in Chapter 8. The US Geological Survey (USGS) has several hydrologic study reports available online that use partial duration series statistics (see <http://water.usgs.gov/> and http://water.usgs.gov/osw/bulletin17b/AGU_Langbein_1949.pdf).

Pre-development Q_2 and Q_{10} shall be determined from the partial duration analysis for the pre-development hourly flow record. Pre-development Q_{10} is the upper threshold of flow rates to be controlled in the post-project condition. The lower flow threshold is a fraction of the pre-development Q_2 determined based on the erosion susceptibility of the receiving stream. Simply multiply the pre-development Q_2 by the appropriate fraction (e.g., $0.1Q_2$) to determine the lower flow threshold.

G.1.6.2 Determining Flow Durations from Continuous Hourly Flow Output

Flow durations must be summarized within the range of flows to control. Flow duration statistics provide a simple summary of how often a particular flow rate is exceeded. To prepare this summary:

- 1) Rank the entire hourly runoff time series output.
- 2) Extract the portion of the ranked hourly time series output from the lower flow threshold to the upper flow threshold – this is the portion of the record to be summarized.
- 3) Divide the applicable portion of the record into 100 equal flow bins (compute the difference between the upper flow threshold (cfs) and lower flow threshold (cfs) and divide this value by 99 to establish the flow bin size).
- 4) Count the number of hours of flow that fall into each flow bin.

Both pre-development and post-project flow duration summary must be based on the entire length of the flow record. Compare the post-project flow duration summary to the pre-development flow duration summary to determine whether it meets performance criteria for post-project flow rates and durations (criteria presented under Section G.1.6).

G.2 Sizing Factors for Hydromodification Management BMPs

Jurisdictional Update:

1. Because of the changes to the flow control performance standard (removal of flow frequency criteria and revision to flow duration criteria), sizing factors, which were developed under the 2007 MS4 Permit, may be retired from use. Designs based on sizing factors would be conservative compared to designs based on the revised flow control performance standard. Use of sizing factors is at the discretion of the ADC and P&EAD.

This section presents sizing factors for design of flow control structural BMPs based on the sizing factor method identified in Chapter 6.3.5.1. The sizing factors included here have been updated based on the requirements in the 2015 MS4 permit and are different than the sizing factors presented in previous manuals. These updated values replace the previous sizing factors shall no longer be used for sizing of hydromodification flow control BMPs. A discussion of the rationale for the update is included below.

The sizing factors included in previous edition was re-printed from the "San Diego BMP Sizing Calculator Methodology," dated January 2012, prepared by Brown and Caldwell (herein "BMP Sizing Calculator Methodology"). These sizing factors were linked to the specific details and descriptions that were presented in the BMP Sizing Calculator Methodology, which included certain assumptions and limited options for modifications. The sizing factors were developed based on the 2007 MS4 Permit. Some of the original sizing factors developed based on the 2007 MS4 Permit and presented in the BMP Sizing Calculator Methodology were not compatible with new requirements of the 2015 MS4 Permit, and therefore were not included in the February 2016 manual. Since publishing the 2016 Model Manual, the Copermittees have developed updated hydromodification factors that more accurately represent the BMP configurations specified in this Manual and account for the revised flow-duration performance standard of the 2015 MS4 Permit (110 percent exceedance allowance for entire flow-duration curve).

The updated sizing factors were generated using continuous simulation models in USEPA SWMM in accordance with the procedures, methodologies, and values presented in Appendix G.1. All sizing factors are in relation to the effective impervious area draining to the BMP.

The sizing factor method is intended for simple studies that do not include diversion, do not include significant offsite area draining through the project from upstream, and do not include offsite area downstream of the project area. Use of the sizing factors is limited to the specific structural BMPs described in this Appendix. When using the sizing factor methodology, the area fraction reported in the sizing tables represents the plan view area at the surface of the BMP before any ponding occurs. The BMP footprint as defined by this methodology is depicted in Figure G.2-1.

Appendix G: Guidance for Continuous Simulation and Hydromodification Management Sizing Factors

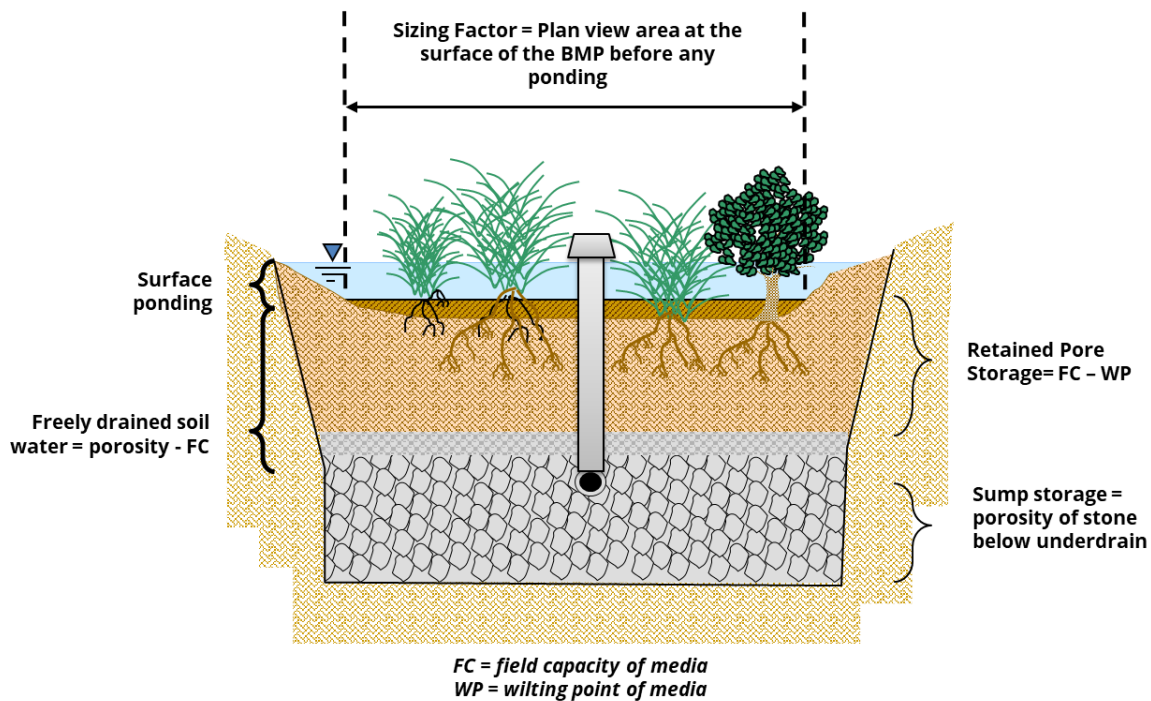

Figure G.2-1. Representation of BMP Footprint for use of Sizing Factors

Sizing factors are available for the following specific structural BMPs:

- **Full infiltration condition:**
 - **Infiltration:** Sizing factors available for A, B, C, and D soils represent surface and/or below-ground structures (infiltration vaults).
- **Partial infiltration condition:**
 - **Biofiltration with partial retention:** Sizing factors available for A, B, C, and D soils represent a bioretention area with bioretention soil media and gravel storage layer, with an underdrain, with gravel storage below the underdrain and a flow control orifice, with no impermeable liner.
- **No infiltration condition:**
 - **Biofiltration:** Sizing factors available for A, B, C, and D soils represent a biofiltration system with bioretention soil media and gravel storage layer, with an underdrain and flow control orifice, with gravel storage, with an impermeable liner (formerly known as flow-through planter and/or biofiltration with impermeable liner)
- **Other:**
 - **Cistern:** Sizing factors available for A, B, C, or D soils represent a vessel with a flow control orifice outlet to meet the hydromodification management performance standard. For this BMP, the sizing factor result is a volume in ft^3 , not a surface footprint in ft^2 .

Appendix G: Guidance for Continuous Simulation and Hydromodification Management Sizing Factors

Sizing factors were created based on three rainfall basins: Lindbergh Field, Oceanside, and Lake Wohlford.

The following information is needed to use the sizing factors:

- Determine the appropriate rainfall basin for the project site from Figure G.2-2, Rainfall Basin Map
- Hydrologic soil group at the project site (use available information pertaining to existing underlying soil type such as soil maps published by the Natural Resources Conservation Service)
- Pre-development and post-pre-project slope categories (low flat = 0% – 5%, moderate = 5% – 10%, steep = >10%)
- Area tributary to the structural BMP
- Area weighted runoff factor (C) for the area draining to the BMP from Table G.2-1. Note: runoff coefficients and adjustments presented in Appendices B.1 and B.2 are for pollutant control only and are not applicable for hydromodification management studies
- Fraction of Q_2 to control (see Chapter 6.3.4)¹¹

When using the sizing factor method, Worksheet G.2-1 may be used to present the calculations of the required minimum areas and/or volumes of BMPs as applicable. Additionally, the “BMP Sizing Spreadsheet V3.0” available at projectcleanwater.org implements the sizing factor methodology.

¹¹ All updated sizing factors refer to the “High Susceptibility” threshold value of $0.1*Q_2$, where Q_2 is determined using the Weibull Plotting position and results of the SWMM model runs for unit pervious catchments (refer to Table G.2-2).

**Appendix G: Guidance for Continuous Simulation and
Hydromodification Management Sizing Factors**

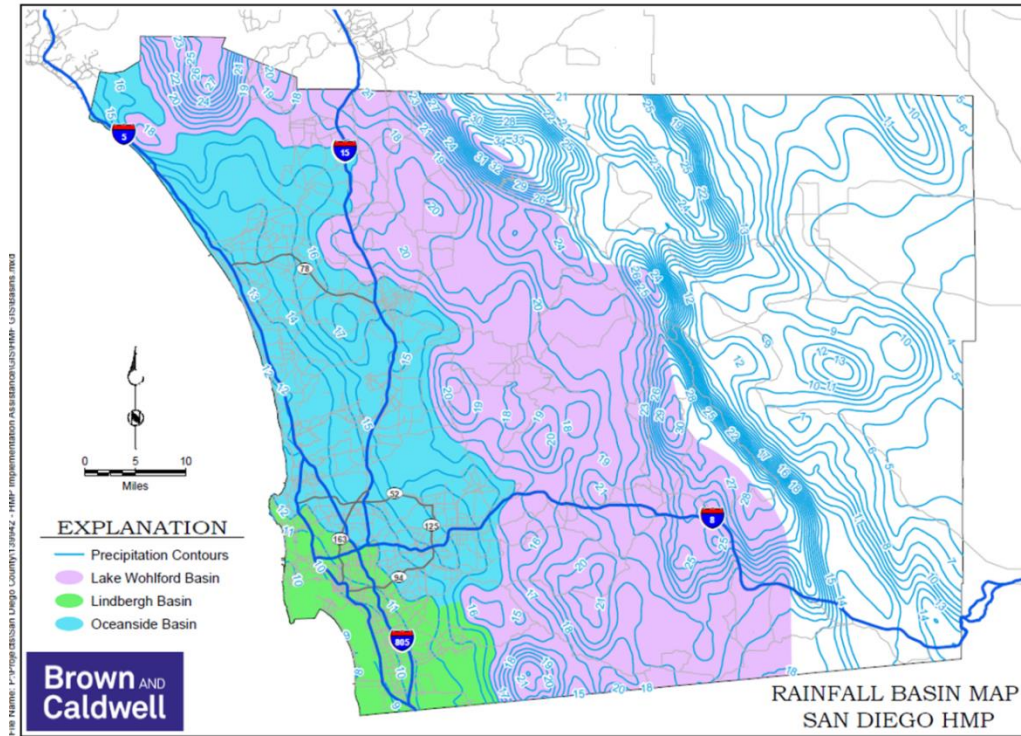

Figure G.2-2.2 Appropriate Rain Gauge for Project Sites

Table G.2-1. Runoff factors for surfaces draining to BMPs for Hydromodification Sizing Factor Method

Surface	Runoff Factor
Roofs	1.0
Concrete	1.0
Pervious Concrete	0.10
Porous Asphalt	0.10
Grouted Unit Pavers	1.0
Solid Unit Pavers on granular base, min. 3/16-inch joint space	0.20
Crushed Aggregate	0.10
Turf block	0.10
Amended, mulched soils	0.10
Landscape	0.10

Appendix G: Guidance for Continuous Simulation and Hydromodification Management Sizing Factors

Worksheet G.2-2. Sizing Factor Worksheet

Site Information			
Project Name:		Hydrologic Unit	
Project Applicant:		Rain: Gauge:	
Jurisdiction:		Total Project Area:	
Assessor's Parcel Number:		Low Flow Threshold:	0.1Q ₂
BMP Name:		BMP Type:	

Areas Draining to BMP						Sizing Factors			Minimum BMP Size		
DMA Name	Area (sf)	Soil Type	Pre-Project Slope	Post Project Surface Type	Runoff Factor (From Table G.2-1)	Surface Area	Surface Volume	Subsurface Volume	Surface Area (sf)	Surface Volume (cf)	Subsurface Volume (cf)
Total DMA Area									Minimum BMP Size*		
									Proposed BMP Size*		

*Minimum BMP Size = Total of rows above.

*Proposed BMP Size ≥ Minimum BMP size.

This page intentionally left blank

G.2.1 Unit Runoff Ratios

Table G.2-3 presents unit runoff ratios for calculating pre-development Q_2 , to be used when applicable to determine the lower flow threshold for low flow control orifice sizing for biofiltration with partial retention, biofiltration, or cistern BMPs. There is no low flow control orifice in the infiltration BMP. The unit runoff ratios are updated from the previously reported BMP Sizing Calculator methodology ratios to account for changes in modeling methodologies. Unit runoff ratios for "urban" and "impervious" cover categories were not transferred to this Manual because of the requirement to control runoff to pre-development condition (see Chapter 6.3.3).

How to use the unit runoff ratios:

Obtain unit runoff ratio from Table G.2-3 based on the project's rainfall basin, hydrologic soil group, and pre-development slope (for redevelopment projects, pre-development slope may be considered if historical topographic information is available, otherwise use pre-project slope). Multiply the area tributary to the structural BMP (A, acres) by the unit runoff ratio (Q_2 , cfs/acre) to determine the pre-development Q_2 to determine the lower flow threshold, to use for low flow orifice sizing.

Table G.2-3. Unit Runoff Ratios for Sizing Factor Method

Rain Gauge	Soil	Pre-Project Slope	Q_2 (cfs/acre)	Q_{10} (cfs/acre)
Lake Wohlford	A	Flat	0.256	0.518
Lake Wohlford	A	Moderate	0.275	0.528
Lake Wohlford	A	Steep	0.283	0.531
Lake Wohlford	B	Flat	0.371	0.624
Lake Wohlford	B	Moderate	0.389	0.631
Lake Wohlford	B	Steep	0.393	0.633
Lake Wohlford	C	Flat	0.490	0.729
Lake Wohlford	C	Moderate	0.495	0.733
Lake Wohlford	C	Steep	0.496	0.735
Lake Wohlford	D	Flat	0.548	0.784
Lake Wohlford	D	Moderate	0.554	0.788
Lake Wohlford	D	Steep	0.556	0.788
Oceanside	A	Flat	0.256	0.679
Oceanside	A	Moderate	0.277	0.694
Oceanside	A	Steep	0.285	0.700

**Appendix G: Guidance for Continuous Simulation and
Hydromodification Management Sizing Factors**

Table G.2-3. Unit Runoff Ratios for Sizing Factor Method (continued)

Rain Gauge	Soil	Pre-Project Slope	Q ₂ (cfs/acre)	Q ₁₀ (cfs/acre)
Oceanside	B	Flat	0.377	0.875
Oceanside	B	Moderate	0.391	0.879
Oceanside	B	Steep	0.395	0.881
Oceanside	C	Flat	0.488	0.981
Oceanside	C	Moderate	0.497	0.985
Oceanside	C	Steep	0.499	0.986
Oceanside	D	Flat	0.571	0.998
Oceanside	D	Moderate	0.575	0.999
Oceanside	D	Steep	0.576	0.999
Lindbergh	A	Flat	0.057	0.384
Lindbergh	A	Moderate	0.073	0.399
Lindbergh	A	Steep	0.082	0.403
Lindbergh	B	Flat	0.199	0.496
Lindbergh	B	Moderate	0.220	0.509
Lindbergh	B	Steep	0.230	0.513
Lindbergh	C	Flat	0.335	0.601
Lindbergh	C	Moderate	0.349	0.610
Lindbergh	C	Steep	0.354	0.613
Lindbergh	D	Flat	0.429	0.751
Lindbergh	D	Moderate	0.437	0.753
Lindbergh	D	Steep	0.439	0.753

G.2.1.1 Low Flow Control Orifice Design

When used as hydromodification flow control BMPs, biofiltration with partial retention, biofiltration, and cistern BMPs include a low flow control orifice to control the rate that flow is released from the underdrain or primary outlet. The sizing factors were developed using a standard process for sizing the low flow control orifice, therefore BMPs designed using the sizing factor method must size the

Appendix G: Guidance for Continuous Simulation and Hydromodification Management Sizing Factors

low flow control orifice using the same basis. The low flow control orifice must be designed to release the lower flow threshold flow rate (fraction of pre-development Q_2) when the water surface elevation in the BMP is equal to the crest elevation of the next outflow structure. To size the low flow control orifice, determine the head on the orifice measured from the bottom of the orifice to the minimum elevation of the next outflow structure of the BMP. The next outflow structure is typically the BMP overflow structure, except in some multi-use BMPs (e.g., BMPs that are designed for flood control in addition to hydromodification management). In this application, the difference between the bottom of the orifice and the centroid of the orifice is small relative to the total head for the calculation and may be neglected in the calculation by measuring from the orifice invert. This calculation is automated in the “BMP Sizing Spreadsheet V3.0” posted on www.projectcleanwater.org.

Steps to size the low flow control orifice:

- Determine pre-development Q_2 using the unit runoff ratios above.
- Multiply pre-development Q_2 by 0.1 to determine the low flow threshold flow rate. Note sizing factors are only available for streams with high susceptibility to erosion where the low flow threshold is $0.1Q_2$.
- Determine the head (H) on the orifice measured from the bottom of the orifice to the minimum elevation of the next outflow structure of the BMP.
- Use the orifice equation (below) and solve for the maximum orifice area to release the lower flow threshold flow rate.
- Consider how the orifice will be created. Determine the constructible dimension(s) (e.g., a standard drill bit diameter) that will produce an orifice with an area equal to or less than the maximum orifice area. The final orifice area determined based on constructible dimensions shall not exceed the maximum orifice area.

$$Q = C \times A \times (64.4 \times H)^{0.5}$$

where:

- | | | |
|---|---|---|
| Q | = | Flow rate in ft ³ per second |
| C | = | Orifice coefficient; in this application use C = 0.65 |
| A | = | Area in ft ² |
| H | = | Head in feet |

G.2.2 Sizing Factors for "Infiltration" BMP

Table G.2-4 presents sizing factors for calculating the required surface area (A) for an infiltration BMP. There is no underdrain and therefore no low flow orifice in the infiltration BMP. Sizing factors were developed for hydrologic soil groups A, B, C, and D. This BMP is generally not applicable in hydrologic soil groups C and D, but applicants have the option if there are no geotechnical or water balance issues and the underlying design infiltration rate for the BMP is greater than 0.5 inch per hour. The infiltration BMP is a surface ponding feature that allows infiltration into the native or amended soils of the BMP surface.

- **Ponding layer:** a nominal 36-inch ponding layer shall be included below the overflow elevation.
- **Design infiltration rate:** the design infiltration rate shall be greater than 0.5 inch per hour.
- **Overflow structure:** San Diego Regional Standard Drawing Type I Catch Basin (D-29). For the purposes of hydromodification flow control other type of overflow structures are allowed.

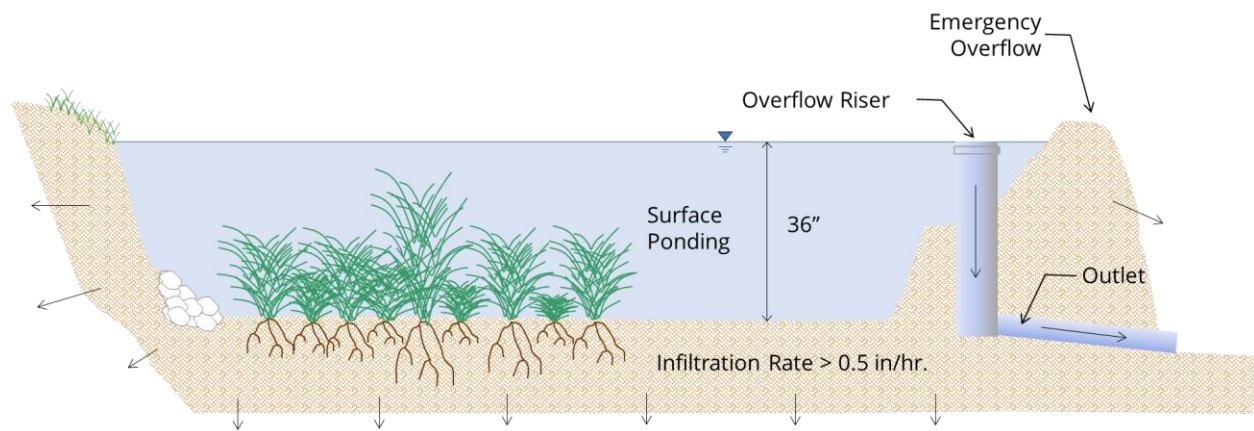

Infiltration BMP Example Illustration

How to use the sizing factors for flow control BMP Sizing:

Obtain sizing factors from Table G.2-4 based on the project's lower flow threshold fraction of Q_2 , hydrologic soil group, pre-project slope, and rain gauge (rainfall basin). Multiply the area tributary to the structural BMP (A , ft^2) by the area weighted runoff factor (C , unitless) (see Table G.2-1) by the sizing factors to determine the required surface area (A , ft^2) for the infiltration BMP. The civil engineer shall provide the necessary surface area of the BMP on the plans.

Additional steps to use this BMP as a combined pollutant control and flow control BMP:

The BMP sized using the sizing factors in Table G.2-4 meets both pollutant control and flow control requirements.

**Appendix G: Guidance for Continuous Simulation and
Hydromodification Management Sizing Factors**

**Table G.2-4. Sizing Factors for Hydromodification Flow Control Infiltration BMPs Designed Using
Sizing Factor Method**

Lower Flow Threshold	Soil Group	Pre-Project Slope	Rain Gauge	A
0.1Q ₂	A	Flat	Lindbergh	0.055
0.1Q ₂	A	Moderate	Lindbergh	0.055
0.1Q ₂	A	Steep	Lindbergh	0.055
0.1Q ₂	B	Flat	Lindbergh	0.045
0.1Q ₂	B	Moderate	Lindbergh	0.045
0.1Q ₂	B	Steep	Lindbergh	0.045
0.1Q ₂	C	Flat	Lindbergh	0.035
0.1Q ₂	C	Moderate	Lindbergh	0.035
0.1Q ₂	C	Steep	Lindbergh	0.035
0.1Q ₂	D	Flat	Lindbergh	0.030
0.1Q ₂	D	Moderate	Lindbergh	0.030
0.1Q ₂	D	Steep	Lindbergh	0.030
0.1Q ₂	A	Flat	Oceanside	0.060
0.1Q ₂	A	Moderate	Oceanside	0.060
0.1Q ₂	A	Steep	Oceanside	0.060
0.1Q ₂	B	Flat	Oceanside	0.050
0.1Q ₂	B	Moderate	Oceanside	0.050
0.1Q ₂	B	Steep	Oceanside	0.050
0.1Q ₂	C	Flat	Oceanside	0.050
0.1Q ₂	C	Moderate	Oceanside	0.050
0.1Q ₂	C	Steep	Oceanside	0.045
0.1Q ₂	D	Flat	Oceanside	0.035
0.1Q ₂	D	Moderate	Oceanside	0.035
0.1Q ₂	D	Steep	Oceanside	0.035

Appendix G: Guidance for Continuous Simulation and Hydromodification Management Sizing Factors

Table G.2-4. Sizing Factors for Hydromodification Flow Control Infiltration BMPs Designed Using Sizing Factor Method (continued)

Lower Flow Threshold	Soil Group	Pre-Project Slope	Rain Gauge	A
0.1Q ₂	A	Flat	L Wohlford	0.085
0.1Q ₂	A	Moderate	L Wohlford	0.085
0.1Q ₂	A	Steep	L Wohlford	0.085
0.1Q ₂	B	Flat	L Wohlford	0.070
0.1Q ₂	B	Moderate	L Wohlford	0.070
0.1Q ₂	B	Steep	L Wohlford	0.070
0.1Q ₂	C	Flat	L Wohlford	0.055
0.1Q ₂	C	Moderate	L Wohlford	0.055
0.1Q ₂	C	Steep	L Wohlford	0.055
0.1Q ₂	D	Flat	L Wohlford	0.040
0.1Q ₂	D	Moderate	L Wohlford	0.040
0.1Q ₂	D	Steep	L Wohlford	0.040

Q₂ = 2-year pre-project flow rate based upon partial duration analysis of long-term hourly rainfall records

A = Surface area (at surface of the BMP before any ponding occurs) sizing factor for flow control

G.2.3 Sizing Factors for Bioretention with Partial Retention

Table G.2-5 presents sizing factors for calculating the required surface area (A) for a biofiltration with partial retention BMP. The BMPs consist of four layers:

- **Ponding layer:** 12 inches active storage, [minimum] 2 inches of freeboard above overflow relief
- **Media Layer:** 18 inches of soil [bioretention soil media]
- **Filter Course:** 6 inches
- **Storage layer:** 18 inches of gravel at 40 percent porosity for A and B soils and 12 inches of gravel at 40 percent porosity for C and D soils. The underdrain offset for A and B soils shall be 18 inches; for C soils it shall be 6 inches and for D soils it shall be 3 inches.
- **Overflow structure:** San Diego Regional Standard Drawing Type I Catch Basin (D-29). For the purposes of hydromodification flow control other type of overflow structures are allowed.

Appendix G: Guidance for Continuous Simulation and Hydromodification Management Sizing Factors

This BMP does not include an impermeable layer at the bottom of the facility to prevent infiltration into underlying soils, regardless of hydrologic soil group. If a facility is to be lined, the designer must use the sizing factors for biofiltration (Refer to Appendix G.2.4).

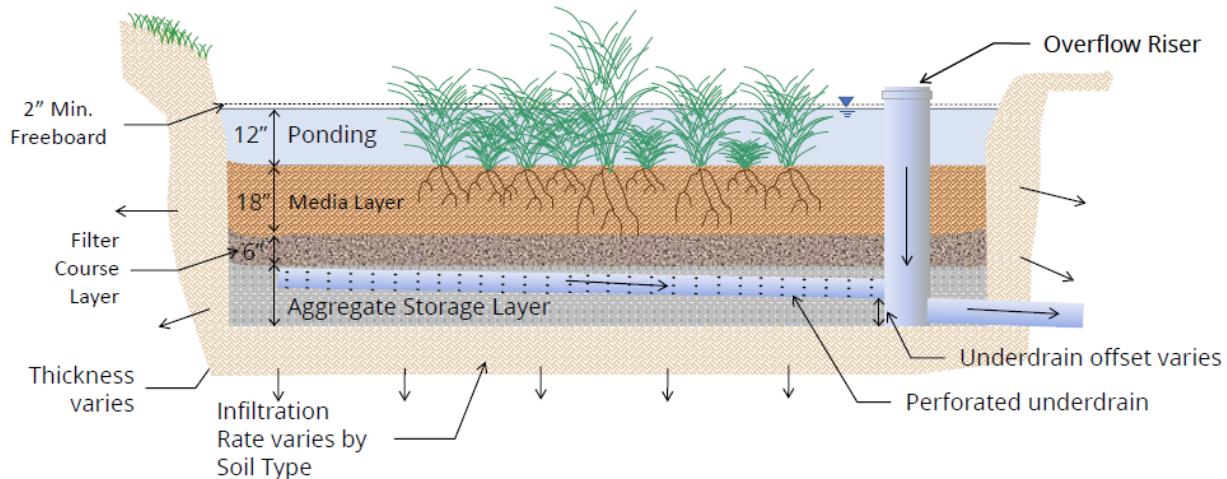

Biofiltration with Partial Retention BMP Example Illustration

How to use the sizing factors for flow control BMP Sizing:

Obtain sizing factors from Table G.2-5 based on the project's lower flow threshold fraction of Q_2 , hydrologic soil group, pre-project slope, and rain gauge (rainfall basin). Multiply the area tributary to the structural BMP (A , ft^2) by the area weighted runoff factor (C , unitless) (see Table G.2-1) by the sizing factors to determine the required surface area (A , ft^2). Select a low flow control orifice for the underdrain that will discharge the lower flow threshold flow at the overflow riser elevation. Standard head (H) for this calculation (based on the standard detail) is 3.0 feet for A or B soils, 3.5 feet for C soils, or 3.75 feet for D soils. The civil engineer shall provide the necessary surface area of the BMP and the underdrain and orifice detail on the plans.

Additional steps to use this BMP as a combined pollutant control and flow control BMP:

The BMP sized using the sizing factors in Table G.2-5 meets both pollutant control and flow control requirements.

**Appendix G: Guidance for Continuous Simulation and
Hydromodification Management Sizing Factors**

**Table G.2-5. Sizing Factors for Hydromodification Flow Control Biofiltration with Partial Retention
BMPs Designed Using Sizing Factor Method**

Lower Flow Threshold	Soil Group	Pre-Project Slope	Aggregate below low orifice invert (inches)	Rain Gauge	A
0.1Q ₂	A	Flat	18	Lindbergh	0.080
0.1Q ₂	A	Moderate	18	Lindbergh	0.080
0.1Q ₂	A	Steep	18	Lindbergh	0.080
0.1Q ₂	B	Flat	18	Lindbergh	0.065
0.1Q ₂	B	Moderate	18	Lindbergh	0.065
0.1Q ₂	B	Steep	18	Lindbergh	0.060
0.1Q ₂	C	Flat	6	Lindbergh	0.050
0.1Q ₂	C	Moderate	6	Lindbergh	0.050
0.1Q ₂	C	Steep	6	Lindbergh	0.050
0.1Q ₂	D	Flat	3	Lindbergh	0.050
0.1Q ₂	D	Moderate	3	Lindbergh	0.050
0.1Q ₂	D	Steep	3	Lindbergh	0.050
0.1Q ₂	A	Flat	18	Oceanside	0.080
0.1Q ₂	A	Moderate	18	Oceanside	0.075
0.1Q ₂	A	Steep	18	Oceanside	0.075
0.1Q ₂	B	Flat	18	Oceanside	0.070
0.1Q ₂	B	Moderate	18	Oceanside	0.070
0.1Q ₂	B	Steep	18	Oceanside	0.070
0.1Q ₂	C	Flat	6	Oceanside	0.070
0.1Q ₂	C	Moderate	6	Oceanside	0.070
0.1Q ₂	C	Steep	6	Oceanside	0.070
0.1Q ₂	D	Flat	3	Oceanside	0.070
0.1Q ₂	D	Moderate	3	Oceanside	0.070
0.1Q ₂	D	Steep	3	Oceanside	0.070

Appendix G: Guidance for Continuous Simulation and Hydromodification Management Sizing Factors

**Table G.2-5. Sizing Factors for Hydromodification Flow Control Biofiltration with Partial Retention
BMPs Designed Using Sizing Factor Method (continued)**

Lower Flow Threshold	Soil Group	Pre-Project Slope	Aggregate below low orifice invert (inches)	Rain Gauge	A
0.1Q ₂	A	Flat	18	L Wohlford	0.110
0.1Q ₂	A	Moderate	18	L Wohlford	0.110
0.1Q ₂	A	Steep	18	L Wohlford	0.105
0.1Q ₂	B	Flat	18	L Wohlford	0.090
0.1Q ₂	B	Moderate	18	L Wohlford	0.085
0.1Q ₂	B	Steep	18	L Wohlford	0.085
0.1Q ₂	C	Flat	6	L Wohlford	0.065
0.1Q ₂	C	Moderate	6	L Wohlford	0.065
0.1Q ₂	C	Steep	6	L Wohlford	0.065
0.1Q ₂	D	Flat	3	L Wohlford	0.060
0.1Q ₂	D	Moderate	3	L Wohlford	0.060
0.1Q ₂	D	Steep	3	L Wohlford	0.060

Q₂ = 2-year pre-project flow rate based upon partial duration analysis of long-term hourly rainfall records

A = Surface area (at surface of the BMP before any ponding occurs) sizing factor for flow control

G.2.4 Sizing Factors for Biofiltration

Table G.2-6 presents sizing factors for calculating the required surface area (A) for a biofiltration BMP (formerly known as flow-through planter and/or biofiltration BMP with impermeable liner). The BMPs consist of four layers:

- **Ponding layer:** 12 inches active storage, [minimum] 2 inches of freeboard above overflow relief
- **Media Layer:** 18 inches of soil [bioretention soil media]
- **Filter Course:** 6 inches
- **Storage layer:** 12 inches of gravel at 40 percent porosity. The underdrain offset shall be 3 inches.

Appendix G: Guidance for Continuous Simulation and Hydromodification Management Sizing Factors

- **Overflow structure:** San Diego Regional Standard Drawing Type I Catch Basin (D-29). For the purposes of hydromodification flow control other type of overflow structures are allowed.

This BMP includes an impermeable liner to prevent infiltration into underlying soils.

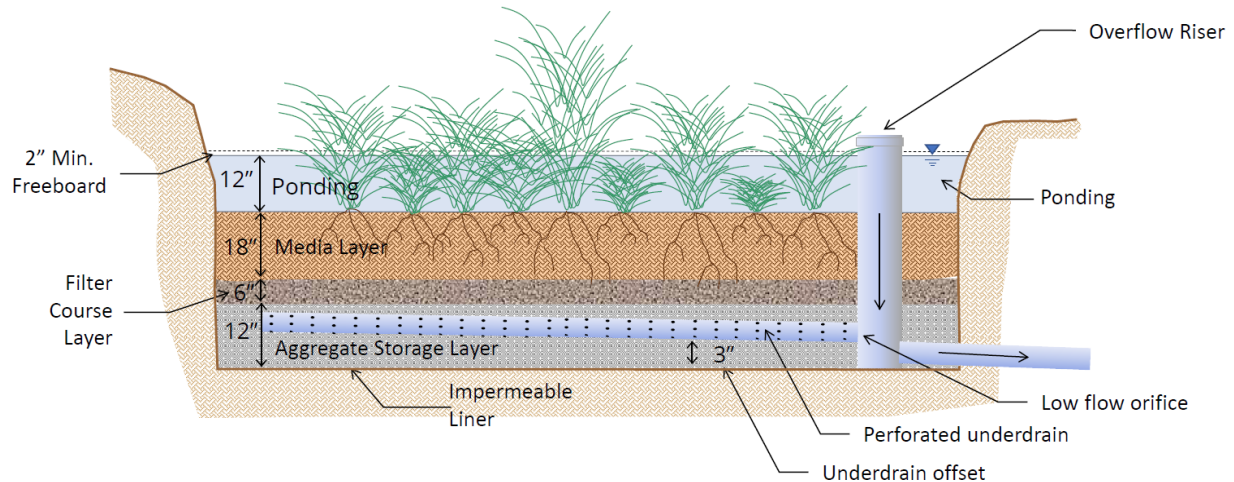

Biofiltration BMP Example Illustration

How to use the sizing factors for flow control BMP Sizing:

Obtain sizing factors from Table G.2-6 based on the project's lower flow threshold fraction of Q_2 , hydrologic soil group, pre-project slope, and rain gauge (rainfall basin). Multiply the area tributary to the structural BMP (A , ft^2) by the area weighted runoff factor (C , unitless) (see Table G.2-1) by the sizing factors to determine the required surface area (A , ft^2). Select a low flow control orifice for the underdrain that will discharge the lower flow threshold flow at the overflow riser elevation. Standard head (H) for this calculation (based on the standard detail) is 3.75 feet for all soil groups. The civil engineer shall provide the necessary surface area of the BMP and the underdrain and orifice detail on the plans.

Additional steps to use this BMP as a combined pollutant control and flow control BMP:

The BMP sized using the sizing factors in Table G.2-6 meets both pollutant control and flow control requirements except for surface drawdown requirements. Applicant must perform surface drawdown calculations and if needed develop a vector management plan (Refer to Section 6.3.7) or revise the BMP design to meet the drawdown requirements. If changes are made to the BMP design applicants must perform site specific continuous simulation modeling (Refer to Appendix G).

**Appendix G: Guidance for Continuous Simulation and
Hydromodification Management Sizing Factors**

**Table G.2-6. Sizing Factors for Hydromodification Flow Control Biofiltration BMPs Designed Using
Sizing Factor Method**

Lower Flow Threshold	Soil Group	Pre-Project Slope	Rain Gauge	A
0.1Q ₂	A	Flat	Lindbergh	0.320
0.1Q ₂	A	Moderate	Lindbergh	0.300
0.1Q ₂	A	Steep	Lindbergh	0.285
0.1Q ₂	B	Flat	Lindbergh	0.105
0.1Q ₂	B	Moderate	Lindbergh	0.100
0.1Q ₂	B	Steep	Lindbergh	0.095
0.1Q ₂	C	Flat	Lindbergh	0.055
0.1Q ₂	C	Moderate	Lindbergh	0.050
0.1Q ₂	C	Steep	Lindbergh	0.050
0.1Q ₂	D	Flat	Lindbergh	0.050
0.1Q ₂	D	Moderate	Lindbergh	0.050
0.1Q ₂	D	Steep	Lindbergh	0.050
0.1Q ₂	A	Flat	Oceanside	0.150
0.1Q ₂	A	Moderate	Oceanside	0.140
0.1Q ₂	A	Steep	Oceanside	0.135
0.1Q ₂	B	Flat	Oceanside	0.085
0.1Q ₂	B	Moderate	Oceanside	0.085
0.1Q ₂	B	Steep	Oceanside	0.085
0.1Q ₂	C	Flat	Oceanside	0.075
0.1Q ₂	C	Moderate	Oceanside	0.075
0.1Q ₂	C	Steep	Oceanside	0.075
0.1Q ₂	D	Flat	Oceanside	0.070
0.1Q ₂	D	Moderate	Oceanside	0.070
0.1Q ₂	D	Steep	Oceanside	0.070

Appendix G: Guidance for Continuous Simulation and Hydromodification Management Sizing Factors

Table G.2-6. Sizing Factors for Hydromodification Flow Control Biofiltration BMPs Designed Using Sizing Factor Method (continued)

Lower Flow Threshold	Soil Group	Pre-Project Slope	Rain Gauge	A
0.1Q ₂	A	Flat	L Wohlford	0.285
0.1Q ₂	A	Moderate	L Wohlford	0.275
0.1Q ₂	A	Steep	L Wohlford	0.270
0.1Q ₂	B	Flat	L Wohlford	0.150
0.1Q ₂	B	Moderate	L Wohlford	0.145
0.1Q ₂	B	Steep	L Wohlford	0.145
0.1Q ₂	C	Flat	L Wohlford	0.070
0.1Q ₂	C	Moderate	L Wohlford	0.070
0.1Q ₂	C	Steep	L Wohlford	0.070
0.1Q ₂	D	Flat	L Wohlford	0.060
0.1Q ₂	D	Moderate	L Wohlford	0.060
0.1Q ₂	D	Steep	L Wohlford	0.060

Q₂ = 2-year pre-project flow rate based upon partial duration analysis of long-term hourly rainfall records
flow control

A = Surface area (at surface of the BMP before any ponding occurs) sizing factor for flow control

G.2.5 Sizing Factors for Biofiltration with Impermeable Liner

Table G.2-7 presents sizing factors for calculating the required surface area (A), surface volume (V₁), and sub-surface volume (V₂) for a biofiltration BMP with impermeable liner (formerly known as flow-through planter). The BMP consists of three layers:

- Ponding layer: 10 inches active storage, [minimum] 2 inches of freeboard above overflow relief
- Growing medium: 18 inches of soil [bioretention soil media]
- Storage layer: 30 inches of gravel at 40 percent porosity [18 inches active storage above underdrain is required, additional dead storage depth below underdrain is optional and can vary]

This BMP includes an underdrain with a low flow orifice 18 inches (1.5 feet) below the bottom of the growing medium. This BMP includes an impermeable liner to prevent infiltration into underlying soils.

Appendix G: Guidance for Continuous Simulation and Hydromodification Management Sizing Factors

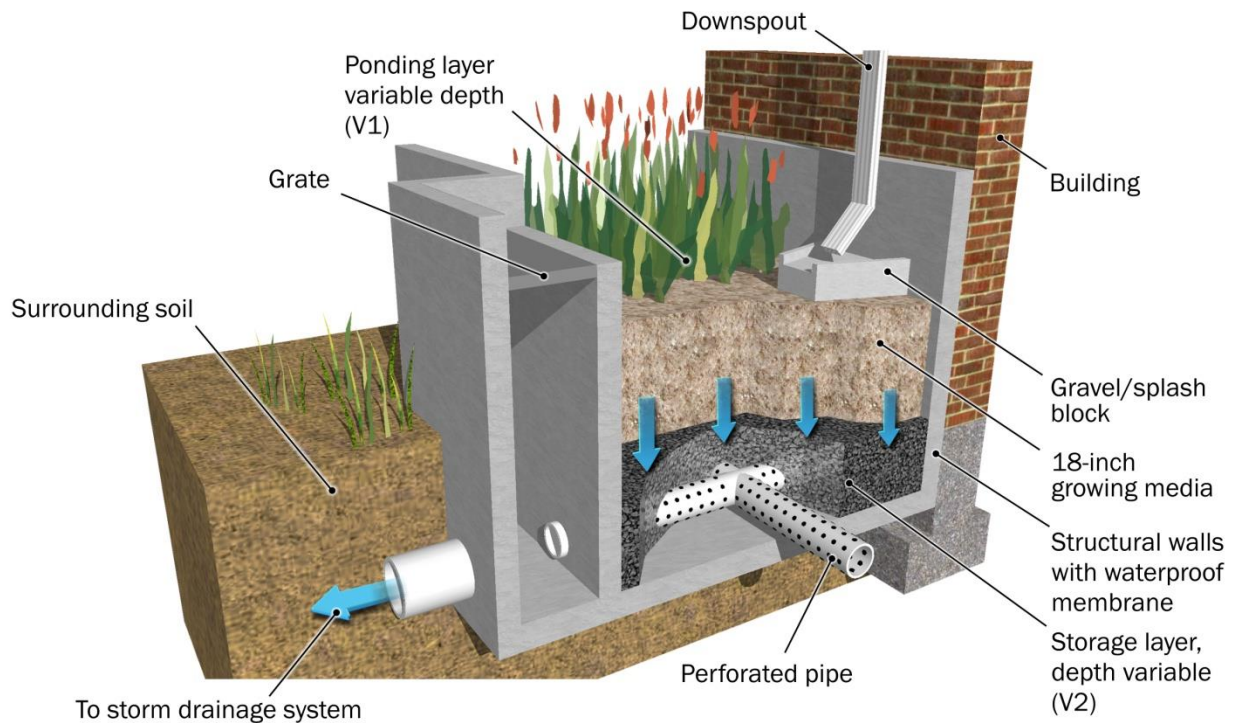

Biofiltration with impermeable liner BMP Example Illustration

Reference: "San Diego BMP Sizing Calculator Methodology," prepared by Brown and Caldwell, dated January 2012

How to use the sizing factors for flow control BMP Sizing:

Obtain sizing factors from Table G.2-7 based on the project's lower flow threshold fraction of Q_2 , hydrologic soil group, pre-development slope, and rain gauge (rainfall basin). Multiply the area tributary to the structural BMP (A , ft^2) by the area weighted runoff factor (C , unitless) (see Table G.2-1) by the sizing factors to determine the required surface area (A , ft^2), surface volume (V_1 , ft^3), and sub-surface volume (V_2 , ft^3). Select a low flow orifice for the underdrain that will discharge the lower flow threshold flow when there is 1.5 feet of head over the underdrain orifice. The civil engineer shall provide the necessary volume and surface area of the BMP and the underdrain and orifice detail on the plans.

Additional steps to use this BMP as a combined pollutant control and flow control BMP:

To use this BMP as a combined pollutant control and flow control BMP, determine the size using the sizing factors, then refer to Appendix B.5 and Appendix F to check whether the BMP meets performance standards for biofiltration for pollutant control. If necessary, adjust the surface area, depth of growing medium, or depth of storage layer as needed to meet pollutant control standards.

**Appendix G: Guidance for Continuous Simulation and
Hydromodification Management Sizing Factors**

Table G.2-7. Sizing Factors for Hydromodification Flow Control Biofiltration BMPs (formerly known as Flow-Through Planters) Designed Using Sizing Factor Method

Sizing Factors for Hydromodification Flow Control Biofiltration with Impermeable Liner BMPs Designed Using Sizing Factor Method						
Lower Flow Threshold	Soil Group	Slope	Rain Gauge	A	V ₁	V ₂
0.5Q ₂	A	Flat	Lindbergh	N/A	N/A	N/A
0.5Q ₂	A	Moderate	Lindbergh	N/A	N/A	N/A
0.5Q ₂	A	Steep	Lindbergh	N/A	N/A	N/A
0.5Q ₂	B	Flat	Lindbergh	N/A	N/A	N/A
0.5Q ₂	B	Moderate	Lindbergh	N/A	N/A	N/A
0.5Q ₂	B	Steep	Lindbergh	N/A	N/A	N/A
0.5Q ₂	C	Flat	Lindbergh	0.115	0.0958	0.0690
0.5Q ₂	C	Moderate	Lindbergh	0.115	0.0958	0.0690
0.5Q ₂	C	Steep	Lindbergh	0.080	0.0667	0.0480
0.5Q ₂	D	Flat	Lindbergh	0.085	0.0708	0.0510
0.5Q ₂	D	Moderate	Lindbergh	0.085	0.0708	0.0510
0.5Q ₂	D	Steep	Lindbergh	0.065	0.0542	0.0390
0.5Q ₂	A	Flat	Oceanside	N/A	N/A	N/A
0.5Q ₂	A	Moderate	Oceanside	N/A	N/A	N/A
0.5Q ₂	A	Steep	Oceanside	N/A	N/A	N/A
0.5Q ₂	B	Flat	Oceanside	N/A	N/A	N/A
0.5Q ₂	B	Moderate	Oceanside	N/A	N/A	N/A
0.5Q ₂	B	Steep	Oceanside	N/A	N/A	N/A
0.5Q ₂	C	Flat	Oceanside	0.075	0.0625	0.0450
0.5Q ₂	C	Moderate	Oceanside	0.075	0.0625	0.0450
0.5Q ₂	C	Steep	Oceanside	0.065	0.0542	0.0390
0.5Q ₂	D	Flat	Oceanside	0.070	0.0583	0.0420
0.5Q ₂	D	Moderate	Oceanside	0.070	0.0583	0.0420
0.5Q ₂	D	Steep	Oceanside	0.050	0.0417	0.0300
0.5Q ₂	A	Flat	L Wohlford	N/A	N/A	N/A
0.5Q ₂	A	Moderate	L Wohlford	N/A	N/A	N/A
0.5Q ₂	A	Steep	L Wohlford	N/A	N/A	N/A
0.5Q ₂	B	Flat	L Wohlford	N/A	N/A	N/A
0.5Q ₂	B	Moderate	L Wohlford	N/A	N/A	N/A
0.5Q ₂	B	Steep	L Wohlford	N/A	N/A	N/A
0.5Q ₂	C	Flat	L Wohlford	0.070	0.0583	0.0420

**Appendix G: Guidance for Continuous Simulation and
Hydromodification Management Sizing Factors**

Table G.2-7. Sizing Factors for Hydromodification Flow Control Biofiltration BMPs (formerly known as Flow-Through Planters) Designed Using Sizing Factor Method (continued)

Sizing Factors for Hydromodification Flow Control Biofiltration with Impermeable Liner BMPs Designed Using Sizing Factor Method						
Lower Flow Threshold	Soil Group	Slope	Rain Gauge	A	V ₁	V ₂
0.5Q ₂	C	Moderate	L Wohlford	0.070	0.0583	0.0420
0.5Q ₂	C	Steep	L Wohlford	0.050	0.0417	0.0300
0.5Q ₂	D	Flat	L Wohlford	0.055	0.0458	0.0330
0.5Q ₂	D	Moderate	L Wohlford	0.055	0.0458	0.0330
0.5Q ₂	D	Steep	L Wohlford	0.045	0.0375	0.0270
0.3Q ₂	A	Flat	Lindbergh	N/A	N/A	N/A
0.3Q ₂	A	Moderate	Lindbergh	N/A	N/A	N/A
0.3Q ₂	A	Steep	Lindbergh	N/A	N/A	N/A
0.3Q ₂	B	Flat	Lindbergh	N/A	N/A	N/A
0.3Q ₂	B	Moderate	Lindbergh	N/A	N/A	N/A
0.3Q ₂	B	Steep	Lindbergh	N/A	N/A	N/A
0.3Q ₂	C	Flat	Lindbergh	0.130	0.1083	0.0780
0.3Q ₂	C	Moderate	Lindbergh	0.130	0.1083	0.0780
0.3Q ₂	C	Steep	Lindbergh	0.100	0.0833	0.0600
0.3Q ₂	D	Flat	Lindbergh	0.105	0.0875	0.0630
0.3Q ₂	D	Moderate	Lindbergh	0.105	0.0875	0.0630
0.3Q ₂	D	Steep	Lindbergh	0.075	0.0625	0.0450
0.3Q ₂	A	Flat	Oceanside	N/A	N/A	N/A
0.3Q ₂	A	Moderate	Oceanside	N/A	N/A	N/A
0.3Q ₂	A	Steep	Oceanside	N/A	N/A	N/A
0.3Q ₂	B	Flat	Oceanside	N/A	N/A	N/A
0.3Q ₂	B	Moderate	Oceanside	N/A	N/A	N/A
0.3Q ₂	B	Steep	Oceanside	N/A	N/A	N/A
0.3Q ₂	C	Flat	Oceanside	0.105	0.0875	0.0630
0.3Q ₂	C	Moderate	Oceanside	0.105	0.0875	0.0630
0.3Q ₂	C	Steep	Oceanside	0.085	0.0708	0.0510
0.3Q ₂	D	Flat	Oceanside	0.090	0.0750	0.0540
0.3Q ₂	D	Moderate	Oceanside	0.090	0.0750	0.0540
0.3Q ₂	D	Steep	Oceanside	0.070	0.0583	0.0420
0.3Q ₂	A	Flat	L Wohlford	N/A	N/A	N/A
0.3Q ₂	A	Moderate	L Wohlford	N/A	N/A	N/A

**Appendix G: Guidance for Continuous Simulation and
Hydromodification Management Sizing Factors**

Table G.2-7. Sizing Factors for Hydromodification Flow Control Biofiltration BMPs (formerly known as Flow-Through Planters) Designed Using Sizing Factor Method (continued)

Sizing Factors for Hydromodification Flow Control Biofiltration with Impermeable Liner BMPs Designed Using Sizing Factor Method						
Lower Flow Threshold	Soil Group	Slope	Rain Gauge	A	V ₁	V ₂
0.3Q ₂	A	Steep	L Wohlford	N/A	N/A	N/A
0.3Q ₂	B	Flat	L Wohlford	N/A	N/A	N/A
0.3Q ₂	B	Moderate	L Wohlford	N/A	N/A	N/A
0.3Q ₂	B	Steep	L Wohlford	N/A	N/A	N/A
0.3Q ₂	C	Flat	L Wohlford	0.085	0.0708	0.0510
0.3Q ₂	C	Moderate	L Wohlford	0.085	0.0708	0.0510
0.3Q ₂	C	Steep	L Wohlford	0.060	0.0500	0.0360
0.3Q ₂	D	Flat	L Wohlford	0.065	0.0542	0.0390
0.3Q ₂	D	Moderate	L Wohlford	0.065	0.0542	0.0390
0.3Q ₂	D	Steep	L Wohlford	0.050	0.0417	0.0300
0.1Q ₂	A	Flat	Lindbergh	N/A	N/A	N/A
0.1Q ₂	A	Moderate	Lindbergh	N/A	N/A	N/A
0.1Q ₂	A	Steep	Lindbergh	N/A	N/A	N/A
0.1Q ₂	B	Flat	Lindbergh	N/A	N/A	N/A
0.1Q ₂	B	Moderate	Lindbergh	N/A	N/A	N/A
0.1Q ₂	B	Steep	Lindbergh	N/A	N/A	N/A
0.1Q ₂	C	Flat	Lindbergh	0.250	0.2083	0.1500
0.1Q ₂	C	Moderate	Lindbergh	0.250	0.2083	0.1500
0.1Q ₂	C	Steep	Lindbergh	0.185	0.1542	0.1110
0.1Q ₂	D	Flat	Lindbergh	0.200	0.1667	0.1200
0.1Q ₂	D	Moderate	Lindbergh	0.200	0.1667	0.1200
0.1Q ₂	D	Steep	Lindbergh	0.130	0.1083	0.0780
0.1Q ₂	A	Flat	Oceanside	N/A	N/A	N/A
0.1Q ₂	A	Moderate	Oceanside	N/A	N/A	N/A
0.1Q ₂	A	Steep	Oceanside	N/A	N/A	N/A
0.1Q ₂	B	Flat	Oceanside	N/A	N/A	N/A
0.1Q ₂	B	Moderate	Oceanside	N/A	N/A	N/A
0.1Q ₂	B	Steep	Oceanside	N/A	N/A	N/A
0.1Q ₂	C	Flat	Oceanside	0.190	0.1583	0.1140
0.1Q ₂	C	Moderate	Oceanside	0.190	0.1583	0.1140
0.1Q ₂	C	Steep	Oceanside	0.140	0.1167	0.0840

Appendix G: Guidance for Continuous Simulation and Hydromodification Management Sizing Factors

Table G.2-7. Sizing Factors for Hydromodification Flow Control Biofiltration BMPs (formerly known as Flow-Through Planters) Designed Using Sizing Factor Method (continued)

Sizing Factors for Hydromodification Flow Control Biofiltration with Impermeable Liner BMPs Designed Using Sizing Factor Method						
Lower Flow Threshold	Soil Group	Slope	Rain Gauge	A	V ₁	V ₂
0.1Q ₂	D	Flat	Oceanside	0.160	0.1333	0.0960
0.1Q ₂	D	Moderate	Oceanside	0.160	0.1333	0.0960
0.1Q ₂	D	Steep	Oceanside	0.105	0.0875	0.0630
0.1Q ₂	A	Flat	L Wohlford	N/A	N/A	N/A
0.1Q ₂	A	Moderate	L Wohlford	N/A	N/A	N/A
0.1Q ₂	A	Steep	L Wohlford	N/A	N/A	N/A
0.1Q ₂	B	Flat	L Wohlford	N/A	N/A	N/A
0.1Q ₂	B	Moderate	L Wohlford	N/A	N/A	N/A
0.1Q ₂	B	Steep	L Wohlford	N/A	N/A	N/A
0.1Q ₂	C	Flat	L Wohlford	0.135	0.1125	0.0810
0.1Q ₂	C	Moderate	L Wohlford	0.135	0.1125	0.0810
0.1Q ₂	C	Steep	L Wohlford	0.105	0.0875	0.0630
0.1Q ₂	D	Flat	L Wohlford	0.110	0.0917	0.0660
0.1Q ₂	D	Moderate	L Wohlford	0.110	0.0917	0.0660
0.1Q ₂	D	Steep	L Wohlford	0.080	0.0667	0.0480

Q₂ = 2-year pre-project flow rate based upon partial duration analysis of long-term hourly rainfall records

A = Surface area sizing factor for flow control

V₁ = Surface volume sizing factor for flow control

V₂ = Subsurface volume sizing factor for flow control

Definitions for "N/A"

Soil groups A and B: N/A in all elements (A, V₁, V₂) for soil groups A and B means sizing factors were not developed for biofiltration (i.e., with an underdrain) for soil groups A and B. If no underdrain is proposed, refer to Appendix G.2.3, Sizing Factors for Bioretention. If an underdrain is proposed, use project-specific continuous simulation modeling

G.2.6 Sizing Factors for "Cistern" BMP

Table G.2-8 presents sizing factors for calculating the required volume (V) for a cistern BMP. In this context, a "cistern" is a detention facility that stores runoff and releases it at a controlled rate. A cistern can be a component of a harvest and use system, however the sizing factor method will not account for any retention occurring in the system. The sizing factors were developed assuming runoff is released from the cistern. The sizing factors presented in this section are to meet the hydromodification management performance standard only. The cistern BMP is based on the following assumptions:

Appendix G: Guidance for Continuous Simulation and Hydromodification Management Sizing Factors

- **Cistern configuration:** The cistern is modeled as a 4-foot tall vessel. However, designers could use other configurations (different cistern heights), as long as the lower outlet orifice is sized to properly restrict outflows and the minimum required volume is provided.
- **Cistern upper outlet:** The upper outlet from the cistern would consist of a weir or other flow control structure with the overflow invert set at an elevation of $7/8$ of the water height associated with the required volume of the cistern – V . For the assumed 4-foot water depth in the cistern associated with the sizing factor analysis, the overflow invert is assumed to be located at an elevation of 3.5 feet above the bottom of the cistern. The overflow weir would be sized to pass the peak design flow based on the tributary drainage area.

How to use the sizing factors:

Obtain sizing factors from Table G.2-8 based on the project's lower flow threshold fraction of Q_2 , hydrologic soil group, pre-project slope, and rain gauge (rainfall basin). Multiply the area tributary to the structural BMP (A , ft^2) by the area weighted runoff factor (C , unitless) (see Table G.2-1) by the sizing factors to determine the required volume (V , ft^3). Select a low flow control orifice that will discharge the lower flow threshold flow at the overflow elevation (i.e., when there is 3.5 feet of head over the lower outlet orifice or adjusted head as appropriate if the cistern overflow elevation is not 3.5 feet tall). The civil engineer shall provide the necessary volume of the BMP and the lower outlet orifice detail on the plans.

Additional steps to use this BMP as a combined pollutant control and flow control BMP:

A cistern could be a component of a full retention, partial retention, or no retention BMP depending on how the outflow is disposed. However, use of the sizing factor method for design of the cistern in a combined pollutant control and flow control system is not recommended. The sizing factor method for designing a cistern does not account for any retention or storage occurring in BMPs combined with the cistern (i.e., cistern sized using sizing factors may be larger than necessary because sizing factor method does not recognize volume losses occurring in other elements of a combined system). Furthermore, when the cistern is designed using the sizing factor method, the cistern outflow must be set to the low flow threshold flow for the drainage area, which may be inconsistent with requirements for other elements of a combined system. To optimize a system in which a cistern provides temporary storage for runoff to be either used onsite (harvest and use), infiltrated, or biofiltered, project-specific continuous simulation modeling is recommended. Refer to Sections 5.6 and 6.3.6.

**Appendix G: Guidance for Continuous Simulation and
Hydromodification Management Sizing Factors**

**Table G.2-8. Sizing Factors for Hydromodification Flow Control Cistern BMPs Designed Using
Sizing Factor Method**

Lower Flow Threshold	Soil Group	Pre-Project Slope	Rain Gauge	V
0.1Q ₂	A	Flat	Lindbergh	0.54
0.1Q ₂	A	Moderate	Lindbergh	0.51
0.1Q ₂	A	Steep	Lindbergh	0.49
0.1Q ₂	B	Flat	Lindbergh	0.19
0.1Q ₂	B	Moderate	Lindbergh	0.18
0.1Q ₂	B	Steep	Lindbergh	0.18
0.1Q ₂	C	Flat	Lindbergh	0.11
0.1Q ₂	C	Moderate	Lindbergh	0.11
0.1Q ₂	C	Steep	Lindbergh	0.11
0.1Q ₂	D	Flat	Lindbergh	0.09
0.1Q ₂	D	Moderate	Lindbergh	0.09
0.1Q ₂	D	Steep	Lindbergh	0.09
0.1Q ₂	A	Flat	Oceanside	0.26
0.1Q ₂	A	Moderate	Oceanside	0.25
0.1Q ₂	A	Steep	Oceanside	0.25
0.1Q ₂	B	Flat	Oceanside	0.16
0.1Q ₂	B	Moderate	Oceanside	0.16
0.1Q ₂	B	Steep	Oceanside	0.16
0.1Q ₂	C	Flat	Oceanside	0.14
0.1Q ₂	C	Moderate	Oceanside	0.14
0.1Q ₂	C	Steep	Oceanside	0.14
0.1Q ₂	D	Flat	Oceanside	0.12
0.1Q ₂	D	Moderate	Oceanside	0.12
0.1Q ₂	D	Steep	Oceanside	0.12

**Appendix G: Guidance for Continuous Simulation and
Hydromodification Management Sizing Factors**

**Table G.2-8. Sizing Factors for Hydromodification Flow Control Cistern BMPs Designed Using
Sizing Factor Method (continued)**

Lower Flow Threshold	Soil Group	Pre-Project Slope	Rain Gauge	V
0.1Q ₂	A	Flat	L Wohlford	0.53
0.1Q ₂	A	Moderate	L Wohlford	0.49
0.1Q ₂	A	Steep	L Wohlford	0.49
0.1Q ₂	B	Flat	L Wohlford	0.28
0.1Q ₂	B	Moderate	L Wohlford	0.28
0.1Q ₂	B	Steep	L Wohlford	0.28
0.1Q ₂	C	Flat	L Wohlford	0.14
0.1Q ₂	C	Moderate	L Wohlford	0.14
0.1Q ₂	C	Steep	L Wohlford	0.14
0.1Q ₂	D	Flat	L Wohlford	0.12
0.1Q ₂	D	Moderate	L Wohlford	0.12
0.1Q ₂	D	Steep	L Wohlford	0.12

Q₂ = 2-year pre-project flow rate based upon partial duration analysis of long-term hourly rainfall records

V = Cistern volume sizing factor

Appendix

H

AUTHORITY BMP DESIGN MANUAL

Forms and Checklists

Appendix H Forms and Checklists

The following Forms/Checklists/Worksheets were developed for use by the project applicant to document the storm water management design. These forms represent the forms not included as part of the Standard and PDP SWQMP Templates in Appendix A:

- H-7: Harvest and Use Feasibility Screening Checklist
- H-8: Categorization of Infiltration Feasibility Condition
- H-9: Factor of Safety and Design Infiltration Rate

Appendix H: Guidance for Investigation Potential Critical Coarse Sediment Yield Areas

Harvest and Use Feasibility Checklist		Form H-7
1. Is there a demand for harvested water (check all that apply) at the project site that is reliably present during the wet season? <input type="checkbox"/> Toilet and urinal flushing <input type="checkbox"/> Landscape irrigation <input type="checkbox"/> Other: _____		
2. If there is a demand; estimate the anticipated average wet season demand over a period of 36 hours. Guidance for planning level demand calculations for toilet/urinal flushing and landscape irrigation is provided in Section B.3.2. [Provide a summary of calculations here]		
3. Calculate the DCV using worksheet B-2.1. DCV = _____ (cubic feet)		
3a. Is the 36-hour demand greater than or equal to the DCV? <input type="checkbox"/> Yes / <input type="checkbox"/> No ⇒ <div style="text-align: center;">↓</div>	3b. Is the 36-hour demand greater than 0.25DCV but less than the full DCV? <input type="checkbox"/> Yes / <input type="checkbox"/> No ⇒ <div style="text-align: center;">↓</div>	3c. Is the 36-hour demand less than 0.25DCV? <input type="checkbox"/> Yes <div style="text-align: center;">↓</div>
Harvest and use appear to be feasible. Conduct more detailed evaluation and sizing calculations to confirm that DCV can be used at an adequate rate to meet drawdown criteria.	Harvest and use may be feasible. Conduct more detailed evaluation and sizing calculations to determine feasibility. Harvest and use may only be able to be used for a portion of the site, or (optionally) the storage may need to be upsized to meet long term capture targets while draining in longer than 36 hours.	Harvest and use are considered to be infeasible.
Is harvest and use feasible based on further evaluation? <input type="checkbox"/> Yes, refer to Appendix E to select and size harvest and use BMPs. <input type="checkbox"/> No, select alternate BMPs.		

Appendix H: Guidance for Investigation Potential Critical Coarse Sediment Yield Areas

Categorization of Infiltration Feasibility Condition		Form H-8	
Part 1 - Full Infiltration Feasibility Screening Criteria			
Would infiltration of the full design volume be feasible from a physical perspective without any undesirable consequences that cannot be reasonably mitigated?			
Criteria	Screening Question	Yes	No
1	Is the estimated reliable infiltration rate below proposed facility locations greater than 0.5 inch per hour? The response to this Screening Question shall be based on a comprehensive evaluation of the factors presented in Appendix C.2 and Appendix D.		
Provide basis: Summarize findings of studies; provide reference to studies, calculations, maps, data sources, etc. Provide narrative discussion of study/data source applicability.			
2	Can infiltration greater than 0.5 inch per hour be allowed without increasing risk of geotechnical hazards (slope stability, groundwater mounding, utilities, or other factors) that cannot be mitigated to an acceptable level? The response to this Screening Question shall be based on a comprehensive evaluation of the factors presented in Appendix C.2.		
Provide basis: Summarize findings of studies; provide reference to studies, calculations, maps, data sources, etc. Provide narrative discussion of study/data source applicability.			

Appendix H: Guidance for Investigation Potential Critical Coarse Sediment Yield Areas

Form H-8 Page 2 of 4			
Criteria	Screening Question	Yes	No
3	<p>Can infiltration greater than 0.5 inch per hour be allowed without increasing risk of groundwater contamination (shallow water table, storm water pollutants or other factors) that cannot be mitigated to an acceptable level? The response to this Screening Question shall be based on a comprehensive evaluation of the factors presented in Appendix C.3.</p>		
<p>Provide basis:</p> <p>Summarize findings of studies; provide reference to studies, calculations, maps, data sources, etc. Provide narrative discussion of study/data source applicability.</p>			
4	<p>Can infiltration greater than 0.5 inch per hour be allowed without causing potential water balance issues such as change of seasonality of ephemeral streams or increased discharge of contaminated groundwater to surface waters? The response to this Screening Question shall be based on a comprehensive evaluation of the factors presented in Appendix C.3.</p>		
<p>Provide basis:</p> <p>Summarize findings of studies; provide reference to studies, calculations, maps, data sources, etc. Provide narrative discussion of study/data source applicability.</p>			
Part 1 Result*	<p>If all answers to rows 1 - 4 are “Yes” a full infiltration design is potentially feasible. The feasibility screening category is Full Infiltration</p> <p>If any answer from row 1-4 is “No”, infiltration may be possible to some extent but would not generally be feasible or desirable to achieve a “full infiltration” design. Proceed to Part 2</p>		

*To be completed using gathered site information and best professional judgment considering the definition of MEP in the MS4 Permit. Additional testing and/or studies may be required by Agency/Jurisdictions to substantiate findings

Appendix H: Guidance for Investigation Potential Critical Coarse Sediment Yield Areas

Form H-8 Page 3 of 4			
Part 2 – Partial Infiltration vs. No Infiltration Feasibility Screening Criteria Would infiltration of water in any appreciable amount be physically feasible without any negative consequences that cannot be reasonably mitigated?			
Criteria	Screening Question	Yes	No
5	Do soil and geologic conditions allow for infiltration in any appreciable rate or volume? The response to this Screening Question shall be based on a comprehensive evaluation of the factors presented in Appendix C.2 and Appendix D.		
Provide basis: Summarize findings of studies; provide reference to studies, calculations, maps, data sources, etc. Provide narrative discussion of study/data source applicability and why it was not feasible to mitigate low infiltration rates.			
6	Can Infiltration in any appreciable quantity be allowed without increasing risk of geotechnical hazards (slope stability, groundwater mounding, utilities, or other factors) that cannot be mitigated to an acceptable level? The response to this Screening Question shall be based on a comprehensive evaluation of the factors presented in Appendix C.2.		
Provide basis: Summarize findings of studies; provide reference to studies, calculations, maps, data sources, etc. Provide narrative discussion of study/data source applicability and why it was not feasible to mitigate low infiltration rates.			

Appendix H: Guidance for Investigation Potential Critical Coarse Sediment Yield Areas

Form H-8 Page 4 of 4			
Criteria	Screening Question	Yes	No
7	<p>Can Infiltration in any appreciable quantity be allowed without posing significant risk for groundwater related concerns (shallow water table, storm water pollutants or other factors)? The response to this Screening Question shall be based on a comprehensive evaluation of the factors presented in Appendix C.3.</p>		
<p>Provide basis:</p> <p>Summarize findings of studies; provide reference to studies, calculations, maps, data sources, etc. Provide narrative discussion of study/data source applicability and why it was not feasible to mitigate low infiltration rates.</p>			
8	<p>Can infiltration be allowed without violating downstream water rights? The response to this Screening Question shall be based on a comprehensive evaluation of the factors presented in Appendix C.3.</p>		
<p>Provide basis:</p> <p>Summarize findings of studies; provide reference to studies, calculations, maps, data sources, etc. Provide narrative discussion of study/data source applicability and why it was not feasible to mitigate low infiltration rates.</p>			
Part 2 Result*	<p>If all answers from row 5-8 are yes, then partial infiltration design is potentially feasible. The feasibility screening category is Partial Infiltration.</p> <p>If any answer from row 5-8 is no, then infiltration of any volume is considered to be infeasible within the drainage area. The feasibility screening category is No Infiltration.</p>		

*To be completed using gathered site information and best professional judgment considering the definition of MEP in the MS4 Permit. Additional testing and/or studies may be required by Agency/Jurisdictions to substantiate findings

Appendix H: Guidance for Investigation Potential Critical Coarse Sediment Yield Areas

Factor of Safety and Design Infiltration Rate Worksheet			Form H-9		
Factor Category		Factor Description	Assigned Weight (w)	Factor Value (v)	Product (p) $p = w \times v$
A	Suitability Assessment	Soil assessment methods	0.25		
		Predominant soil texture	0.25		
		Site soil variability	0.25		
		Depth to groundwater/impervious layer	0.25		
		Suitability Assessment Safety Factor, $S_A = \sum p$			
B	Design	Level of pretreatment/ expected sediment loads	0.5		
		Redundancy/resiliency	0.25		
		Compaction during construction	0.25		
		Design Safety Factor, $S_B = \sum p$			
Combined Safety Factor, $S_{total} = S_A \times S_B$					
Observed Infiltration Rate, inch/hr, $K_{observed}$ (Corrected for test-specific bias)					
Design Infiltration Rate, inches/hour, $K_{design} = K_{observed} / S_{total}$					
Supporting Data					
Briefly describe infiltration test and provide reference to test forms:					

Appendix



AUTHORITY BMP DESIGN MANUAL

USEPA Green Streets Handbook

Appendix I USEPA Green Streets Handbook

The following handbook is attached to provide guidance on green streets design. New or retrofit sidewalks, and retrofit or redeveloped existing paved alleys, streets, and roads, may qualify for PDP exemption if they are designed in accordance with the following handbook. The project proponent should consult with the P&EAD and ADC for additional restrictions on PDP exemption.



Green Streets Handbook

Acknowledgments

Credit should be given to the many local government officials and practicing professionals who offered their time and provided tours and examples of their work and designs to bring this document to press.

Special acknowledgment goes to Alisha Goldstein who was the primary author of the Green Streets Handbook. The document was researched, written and designed during her tenure as an Oak Ridge Institute for Science and Education (ORISE) participant at the U.S. Environmental Protection Agency (USEPA).

The Low Impact Development Center, Horsley Witten Group, RBF Consulting and Tetra Tech, Inc., assisted with document development, content review, development of original graphics and images, and editing and formatting the document. Images were provided by Credit Valley Conservation, the New Hampshire Stormwater Center, Hazen and Sawyer, Minnesota Pollution Control Agency and Clean Water Services.

Reviewers included staff from USEPA's Office of Water, Office of Sustainable Communities, Office of Research and Development, and USEPA regional offices. This document was prepared for USEPA Office of Water/Office of Wetlands, Oceans and Watersheds/Nonpoint Source Management Branch.

Disclaimers

This document serves as a guide to green infrastructure best management practices; selection of and specifications for individual project designs should be based on a thorough analysis of site conditions and awareness of local regulations.

Mention of, or referral to, non-EPA programs, products or services, and/or links to non-EPA sites, does not imply official EPA endorsement of, or responsibility for, the opinions, ideas, data or products presented therein, or guarantee the validity of the information provided. Mention of programs, products or services on non-EPA websites is provided solely as a pointer to information on topics related to environmental protection that may be useful to the intended audience.

Contents

Preface	ii	4 Design Considerations	4-1
1 Addressing Stormwater Runoff	1-1	4.1 Design Checklist.....	4-2
1.1 Road-Related Networks and Stormwater Runoff	1-2	4.2 Selecting Appropriate Practices	4-3
1.2 Stormwater Solutions: Green Streets.....	1-4	4.3 Accommodating Utilities.....	4-5
1.3 Benefits of Green Streets	1-7	4.4 Capturing Stormwater Runoff Types	4-6
1.4 Additional Resources: Green Infrastructure.....	1-12	4.5 Managing Stormwater Flow.....	4-9
2 Transportation Typologies and Green Infrastructure Practices	2-1	4.6 Planning for Maintenance	4-14
2.1 Transportation Typologies	2-2	4.7 Selecting Soil Media and Vegetation	4-15
2.2 Arterials	2-5	4.8 Providing Pedestrian Access.....	4-17
2.3 Collector Roads.....	2-7	4.9 Ensuring Pedestrian Safety	4-18
2.4 Local Roads	2-9	4.10 Enhancing Street Design	4-19
2.5 Alleys.....	2-11	4.11 Accounting for Extreme Weather.....	4-21
2.6 Parking Lots.....	2-12	4.12 Avoiding Design Flaws	4-22
2.7 Identifying Opportunities for Green Infrastructure Placement...2-14		5 Pretreatment Practice Options	5-1
2.8 Reconfiguring Designs to Create Space for Green Infrastructure	2-17	5.1 Pretreatment: Sediment Forebays	5-2
3 Developing a Green Streets Program: A Process Overview	3-1	5.2 Pretreatment: Vegetated Filter Strips	5-4
3.1 Programmatic Process Overview.....	3-2	5.3 Pretreatment: Swales	5-6
3.2 Establish Objectives	3-3	5.4 Pretreatment: Modified Catch Basins	5-8
3.3 Identify Priority Area(s).....	3-4	5.5 Pretreatment: Flow-Through Structures	5-10
3.4 Characterize Sites	3-5	6 Green Street Stormwater Practices	6-1
3.5 Develop Site-Specific Stormwater Plan.....	3-6	6.1 Bioretention (Rain Gardens)	6-2
3.6 Engage Community Partners.....	3-7	6.2 Bioswales.....	6-7
		6.3 Stormwater Curb Extensions.....	6-11
		6.4 Stormwater Planters.....	6-16
		6.5 Stormwater Tree Systems	6-20
		6.6 Infiltration Trenches.....	6-27
		6.7 Subsurface Infiltration and Detention	6-31
		6.8 Permeable Pavement.....	6-34
		7 References	7-1

Preface

In large U.S. cities, 25 percent to more than 60 percent of the land area is covered by impervious roadways, alleys, driveways, sidewalks and surface parking lots. Stormwater runoff from these areas can produce significant runoff volumes and carry pollutant loads that negatively impact the water quality of surface waterbodies and reduce groundwater recharge because of the loss of soil infiltrative capacity. This handbook is intended to provide the reader with a systematic process to begin reducing the impervious surface footprint of the public right-of-ways and associated off-street surface parking areas.

Green streets can provide many environmental, social and economic benefits. In addition to the stormwater runoff reduction and water quality improvement benefits, green streets can be designed to calm traffic, provide safer pedestrian and bicycle paths, mitigate urban heat island effects, improve community aesthetics, promote a sense of place and stimulate community investments. These enhancements can help to make a “green and complete street” that is safe and accessible for all users while also being friendlier to the environment and beneficial for the community at large.

This handbook is intended to help state and local transportation agencies, municipal officials, designers, stakeholders and others to select, design and implement site design strategies and green infrastructure practices for roads, alleys and parking lots. Green infrastructure practices are designed to mimic natural systems by intercepting, infiltrating and evapotranspiring stormwater to reduce runoff and protect or restore site and watershed hydrology.

The document provides background information on street and road typologies and offers a programmatic framework to use when identifying areas

that can be initially designed or later retrofitted with green infrastructure practices or systems. The handbook also contains information about green street design considerations, pretreatment and stormwater management practices, and external resources with additional detail for readers who wish to go deeper into a specific topic.



Stormwater tree pits in a parking lot, Reston, VA.

Don Wayne, USEPA

1 Addressing Stormwater Runoff

In This Chapter

- 1.1 Road-Related Networks and Stormwater Runoff
- 1.2 Stormwater Solutions: Green Streets
- 1.3 Benefits of Green Streets (Environmental, Social, Economic)
- 1.4 Additional Resources: Green Infrastructure

This chapter provides an overview of stormwater runoff from transportation infrastructure, including typical pollutant concentrations and common transportation-related sources of those pollutants. Green streets can be designed to incorporate a variety of green infrastructure practices to manage stormwater onsite, where precipitation falls. Green streets, which can also be part of “complete street” solutions, can provide many benefits including environmental, social and economic benefits. Many states and local governments across the country have also developed green street and green infrastructure design manuals that transportation designers can use.



Eric Vance, USEPA

Clean water is essential for protecting swimmers' health.



Eric Vance, USEPA

Runoff from urbanized areas contributes to pollution and flooding.

1.1 Road-Related Networks and Stormwater Runoff

Transportation Infrastructure Affects Stormwater Runoff Volume and Pollutant Load

Roads and parking lots are a highly visible part of the landscape. Counties, cities and towns control 76 percent of the more than 4 million U.S. roads. The remaining road miles are managed by state highway agencies (19 percent) and federal and other jurisdictions (4 percent) (FHWA 2016). Roadways are a critical component of the nation’s infrastructure, but because of their imperviousness and associated pollutant loadings they can also significantly impact water resources.

Transportation-related land uses represent an especially high percentage of overall impervious surface area within urban and suburban areas. Within the urban environment, roads, driveways, sidewalks and parking lots can constitute up to 70 percent of the impervious surface area (Tilley 2006). When it rains or snows, the roadway networks can collect and convey large volumes of stormwater runoff, facilitating the transport of the pollutants deposited on the roadways from vehicles, the atmosphere, road construction or adjacent land uses. As shown in Table 1-1, the types of pollutant loadings depend on a variety of factors, including traffic volume, land use, total impervious surface area, storm events (intensity and duration), and accidental spills.

Table 1-1. Summary of the pollutant types found in road runoff (FHWA 1984)

Pollutant	Sources	
Particulates	Pavement wear Vehicles Atmospheric deposition	Rubber tire wear Winter sanding
Nitrogen and phosphorus	Atmospheric deposition Fertilizer Sediment	
Metals (e.g., zinc, iron, copper, cadmium, chromium, nickel, manganese)	Grease Tire wear Motor oil Brake linings	Vehicle rust Steel structures Engine components Diesel and gasoline
Sodium, calcium, chloride	Deicing salts	
Bacteria	Animal waste	



Transportation network in Chicago, IL.



Land use patterns in a city.



Impervious expanse of a parking lot.

Two of the largest factors that determine pollutant loads are traffic volume and surrounding land uses. Greater traffic volume, measured in average daily traffic, results in increased amounts of vehicle-associated pollutants (Table 1-2). Likewise, areas that have rapid turnover of parked cars (e.g., retail parking areas) typically generate higher levels of contamination because of the vehicle-associated pollutant deposition and surface wear associated with frequent starting of vehicles (NRC 2008).

Surrounding land uses also affect the volume of runoff on roadways. Impervious surfaces, especially directly connected areas, convey runoff that picks up pollutants as it flows. Studies have shown that stream health (as measured by the concentration of pollutants, habitat quality, and aquatic species diversity and abundance) decreases as the amount of impervious area increases in a watershed (Arnold and Gibbons 1996). Large volumes of runoff entering streams can cause erosion that affects downstream water quality, destabilizes stream channels and damages habitat. Runoff can also lead to flooded and closed roadways, creating a nuisance for users.

Stormwater runoff flowing off impervious surfaces collects and transports pollutants such as metals, hydrocarbons, bacteria, excess nutrients and sediments. Under conventional drainage system designs, these pollutants typically are discharged untreated directly into receiving water bodies such as streams, lakes and bays.

Fortunately, communities can install practices to help mitigate stormwater-caused impacts. By replicating a site's original hydrology and encouraging the capture, infiltration and evapotranspiration of runoff, transportation network designers and planners can reduce excess stormwater flows while also managing pollutant loadings. Using these techniques represents a sound approach to protecting water quality while also meeting a community's transportation needs.

Table 1-2. Summary of pollutant concentrations found in road runoff from highways with small and large traffic volumes

Pollutant	Event mean concentration for highways with fewer than 30,000 vehicles/day (mg/L)	Event mean concentration for highways with more than 30,000 vehicles/day (mg/L)
Total suspended solids	41	142
Volatile suspended solids	12	39
Total organic carbon	8	25
Chemical oxygen demand	49	114
Nitrite and nitrate	0.46	0.76
Total Kjeldahl nitrogen	0.87	1.83
Phosphate phosphorus	0.16	0.40
Copper	0.02	0.05
Lead	0.08	0.40
Zinc	0.08	0.33

Source: Driscoll et al. 1990

Notes: mg/L = milligrams per liter

USEPA Copper-Free Brake Initiative

The U.S. Environmental Protection Agency (USEPA), states and the automotive industry are working together to reduce the use of copper and other materials in motor vehicle brake pads. The wearing of brake pads onto roadway surfaces contributes excessive levels of copper and other pollutants to waterways. The automotive industry has agreed to reduce copper in brake pads to less than 5 percent by weight in 2021 and 0.5 percent by 2025. For more information see USEPA's [Copper-Free Brake Initiative website](#).

1.2 Stormwater Solutions: Green Streets

Using Natural Processes to Control Stormwater

Streets and parking lots can be designed using a variety of practices that mimic or preserve natural drainage processes to manage stormwater. These practices retain stormwater and snowmelt and promote infiltration into the ground to reduce runoff volumes that may contribute to flooding and water quality problems (Figure 1-1). This handbook uses the term green infrastructure to describe these practices. As defined under Section 502 of the Clean Water Act (CWA): "Green infrastructure means the range of measures that use plant or soil systems, permeable pavement or other permeable surfaces or substrates, stormwater harvest and reuse, or landscaping to store, infiltrate, or evapotranspire stormwater and reduce flows to sewer systems or to surface waters."

This handbook is focused on green infrastructure specifically for stormwater management practices in transportation infrastructure, such as roads and parking lots, but the term green infrastructure varies in its use in other

contexts. Conservation ecologists use green infrastructure to describe the creation and networking of natural ecosystems and greenway corridors (e.g., forests, floodplains) that provide ecological services and benefits. In the context of stormwater, USEPA uses green infrastructure to refer to practices such as green roofs, porous pavement, swales and rain gardens that largely rely on using soil and vegetation to infiltrate, evapotranspire, and/or harvest stormwater runoff and reduce flows entering drainage collection systems.

Some use other terms to reference the same practices as green infrastructure for stormwater management. For example, low impact development (LID) is a management approach and a set of practices that can reduce runoff and pollutant loadings by managing runoff as close to its source as possible. Other terms include low impact design, sustainable urban drainage systems, water-sensitive urban design and green stormwater infrastructure. The definitions of these terms may vary slightly among organizations and industry professionals; however, these concepts are generally captured in the CWA definition of green infrastructure. Therefore, this handbook will use the term green infrastructure from here forward.

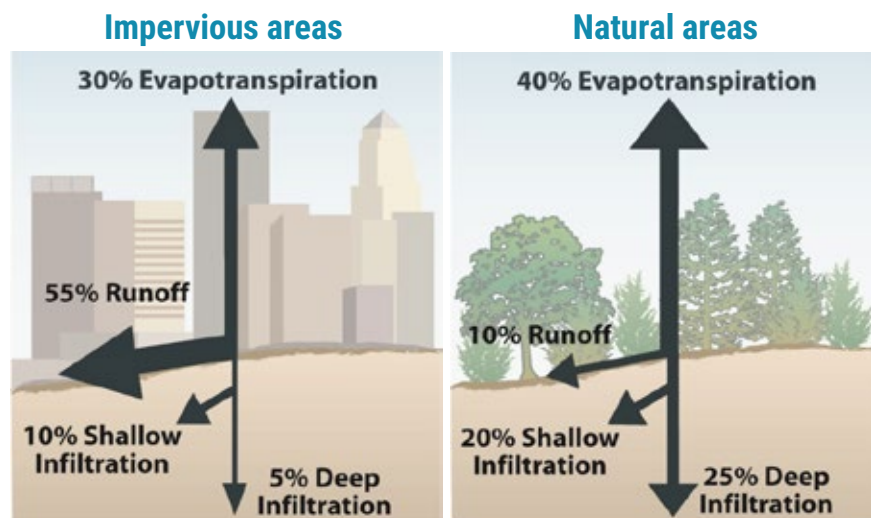

Figure 1-1. When impervious areas (roads, rooftops, parking lots) cover much of the land (left image), more than half the rainfall runs off and flows directly into surface waters, allowing only 15 percent of rain water to soak into the ground. In contrast, areas that are designed to mimic natural areas (right image) allow only 10 percent of rain to run off and nearly half to soak into the ground.

Green Infrastructure in Transportation Networks

Traditional stormwater management systems along roads typically direct runoff into pipes or channels that often carry runoff great distances from where precipitation falls. In contrast, a *green street* incorporates a variety of green infrastructure practices that manage stormwater onsite, where (or very near to where) the precipitation falls. Because green infrastructure techniques are location-independent and can be applied across different regions and climatic zones, designers can adjust the basic forms and processes of practices to best suit local physical, social, and climatic conditions and goals. As discussed in Chapter 2, green infrastructure elements that re-create natural areas can be incorporated into almost all transportation projects.

Green Infrastructure Practices Rely on Natural Processes to Capture and Clean Stormwater

Strategies for green infrastructure design rely on naturally occurring hydrological and biophysical processes to manage the quantity of flow and improve water quality (Figures 1-2 and 1-3).

Hydrologic processes:

Infiltration. Water moves from the ground surface into the soil.

Detention. Water is stored temporarily, thus delaying conveyance downstream.

Retention. Instead of flowing downstream, water is captured and stored onsite for later evapotranspiration or infiltration.

Interception. Vegetation or buildings capture precipitation.

Evapotranspiration. The leaves of plants release water into the atmosphere.

Biophysical processes:

Filtration. Vegetation, soil and plant roots strain organic matter, phosphorus and suspended solids out of stormwater.

Sedimentation. Sediment drops out of suspension and accumulates as stormwater slows and pools in the practice.

Adsorption. Pollutants and excess nutrients carried in stormwater attach to clay particles in the soil and remain in place.

Microbial action. Bacteria in the soil and plant roots break down the pollutants and nutrients.

Uptake. Plants and soil organisms absorb metals and use nutrients such as nitrogen and phosphorus for their growth.



USEPA

Figure 1-2. Modifying or designing parking lot islands as bioretention areas can capture and temporarily store runoff, allowing the water time to infiltrate the soil or be evapotranspired.



Alisha Goldstein

Figure 1-3. Soil and plants absorb and filter out excess nutrients and other pollutants from runoff, while microbes in the soil help break down the chemical compounds.

Elements Support Complete Street Initiatives

Developing a green streets program complements the nationally recognized [Complete Streets](#) policy initiative supported by the Federal Highway Administration (FHWA) and USEPA. This initiative promotes street designs that promote neighborhood character, stimulate economic development, and serve the mobility and access needs of all users—motorists, transit riders, bicyclists and pedestrians. As seen in Figure 1-4, Complete Street objectives are primarily achieved by using measures to calm traffic and create well-defined barriers between transportation types (e.g., chicanes, islands, curb extensions, bike lanes).

Fortunately, many communities across the country recognize that a street is not necessarily “complete” without features that also serve environmental goals, and they strive to use traffic-calming measures that can double as stormwater-control features. For example, by placing a vegetated stormwater curb extension at an intersection or near a crosswalk, community transportation designers can encourage reduced traffic speeds and alert drivers to activity occurring adjacent to the road while also capturing street runoff. Adding a well-marked pervious pavement bicycle lane intercepts runoff and protects bicyclists from vehicular traffic. Similarly, planting street trees helps define road boundaries, protects pedestrians and motorists, and intercepts and absorbs rainfall.

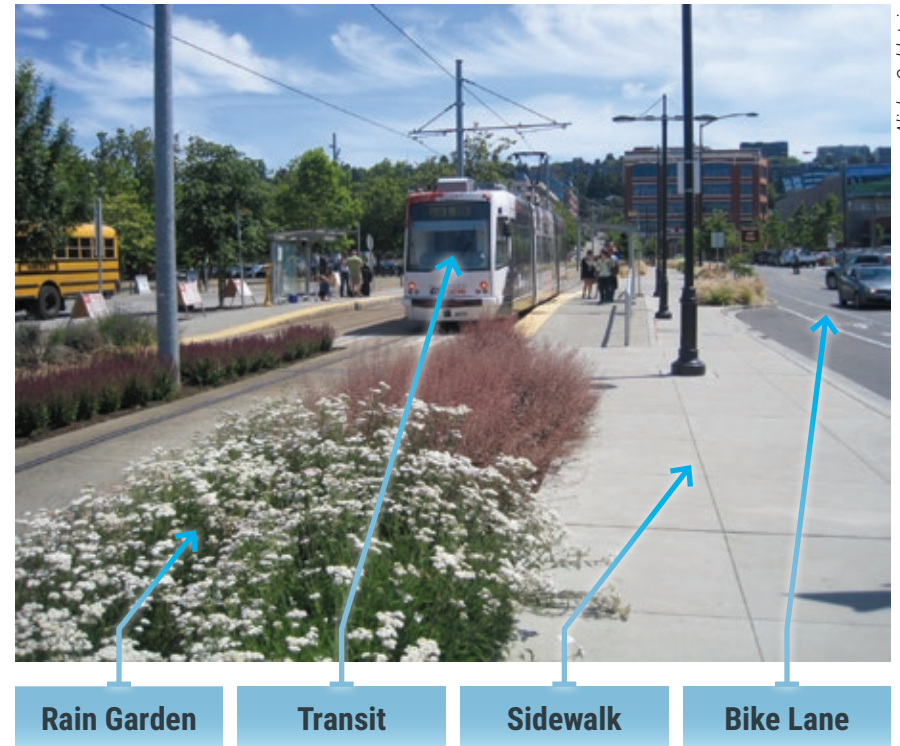

Figure 1-4. A green and “complete street” in Seattle, Washington, includes specific streetcar, vehicle, bike and pedestrian zones and a rain garden and vegetated stormwater curb extensions to capture and treat runoff.

For More Information—Green Streets and Complete Streets

- [Green Streets: A Conceptual Guide to Effective Green Streets Design Solutions](#). USEPA (2000)
- [Managing Wet Weather with Green Infrastructure Municipal Handbook: Green Streets](#). USEPA (2015)
- [G3 Partnership: Green Streets, Green Towns, Green Jobs](#). USEPA
- [Urban Street Stormwater Guide](#) (2017) and [Urban Street Design Guide](#) (2013). (\$) National Association of City Transportation Officials
- [Complete Streets](#). Smart Growth America/Complete Streets Coalition
- [Boston Complete Streets](#). Boston Transportation Department, MA (2013)
- [Complete Streets](#). U.S. Department of Transportation, FHWA
- [Toronto Complete Streets Guidelines](#). City of Toronto, Canada

1.3 Benefits of Green Streets

Green Streets Provide Environmental, Social and Economic Benefits

Green streets are an investment in your community because good designs can provide many additional benefits beyond stormwater management. The design of streets and public rights-of-way can affect the public's perception of a community, influence the behavior of residents and visitors, and shape development decisions, while also helping to create a sense of place. The use of green streets can provide numerous benefits, such as:

- Improved water quality
 - Enhanced community resilience
 - Increased groundwater recharge
 - Enhanced wildlife habitat
 - Improved air quality
 - Reduced urban heat island effects
- Increased pedestrian safety and traffic calming
 - Enhanced well-being of individuals
 - Increased sense of community
 - Increased property values
 - Reduced water treatment costs
 - Reduced infrastructure costs
 - Reduced property damage due to flooding

These benefits are grouped and described in further detail on the following pages.



Low Impact Development Center

Sketch of green street components such as a permeable pavement crosswalk, curb bump-outs and bioretention applied to a local road.

Environmental Benefits of Green Streets



Improves Water Quality

The green infrastructure elements incorporated into green streets help decrease the volume of stormwater runoff and pollutants entering water bodies by:

- Capturing the small, frequently occurring storm events.
- Filtering the first flush of runoff that can contain high concentrations of pollutants.
- Slowing down and temporarily storing runoff.
- Reducing erosion and sedimentation that can negatively impact aquatic habitat and destabilize stream channels.

Green streets can be designed to use the processes of filtration or infiltration to reduce the pollutant loadings that are discharged into waterways. The most cost-effective systems are typically soil-based vegetated designs, although permeable pavements, filtration and infiltration systems can also be used to mitigate the effects of stormwater runoff volumes and pollutant loadings from roads, rights-of-way and parking lots.



Enhances Community Resilience

The use of green streets can increase resilience to changing weather patterns and can help save energy.

Incorporating street trees and green infrastructure practices that include vegetation (e.g., bioretention cells, bioswales) in the right-of-way can provide cooling and wind break effects that reduce energy use by nearby homes and businesses and, as a result, reduce emissions at nearby power plants. Green streets can also be designed to promote alternative modes of transportation such as walking and biking to reduce vehicle use and associated emissions (NCSC, n.d).



Increases Groundwater Recharge

Green street practices that infiltrate runoff, such as bioretention cells, bioswales, infiltration planters and permeable pavement, are designed to allow runoff to drain into subsurface soils and recharge groundwater supplies.

Recharging aquifers can be particularly important in areas of the country that have limited groundwater supplies and are challenged to meet their water supply needs.

Stormwater runoff from impervious areas like streets can be directed to infiltration practices that help recharge groundwater resources. An April 2016 [USEPA study](#) of stormwater retention practices used to recharge groundwater found that the monetary value of this recharged water can be worth millions of dollars in some states.



Enhances Wildlife Habitat

Vegetated landscape areas can provide habitat for wildlife. Green infrastructure can be used to mitigate the effect of habitat loss that is typically a result of urbanization.

Patches of vegetation and/or trees incorporated into a community's green infrastructure can serve as a nesting location for birds, temporary resting places for migrating wildlife, or sources of food for pollinators. In rural settings, larger areas of green infrastructure can serve both as habitat and wildlife corridors that enable animals to migrate.

Environmental Benefits of Green Streets, continued



Improves Air Quality

Trees and other vegetation on green streets can improve air quality by directly removing air pollution and slowing temperature-dependent reactions that form particulate matter that is hazardous to human health (MWCOCG 2007; Vingarzan and Taylor 2003). The increased shade and evapotranspiration provided by trees lowers air and surface temperature of impervious areas, which can reduce the amount of electricity needed for cooling and thus reduce power plant emissions of pollutants. These benefits are of special importance to communities designated by the USEPA as nonattainment areas for the 8-hour ozone standard due to ground-level ozone and fine particulates in the ambient air.

The monetary and quantitative value of the air quality benefits that can accrue from trees can be calculated by using standard software models such as [i-Tree](#), which is a suite of applications developed by the U.S. Department of Agriculture (USDA) Forest Service to design and evaluate urban forestry efforts. The i-Tree family of applications (USFS 2014) includes:

1. i-Tree Streets, which helps quantify the dollar value of environmental and aesthetic benefits.
2. i-Tree Hydro, which provides watershed scale analyses of vegetation and impervious cover effects on hydrology.
3. i-Tree Eco, which documents a range of ecosystem benefits, such as carbon storage and sequestration, oxygen production, avoided runoff and energy savings.
4. i-Tree Design, which can help designers determine the benefits of specific trees in a landscape design.



Reduces Urban Heat Island Effect

Green streets also can be used to reduce urban heat island impacts that result from solar radiation absorbed by pavement, buildings and other hard surfaces and reflected as heat (USEPA 2008). Temperatures in urban areas can average 5 to 10 degrees Fahrenheit higher than those in suburban areas. Using reflective surfaces (e.g., light-colored pavements, sidewalks) and incorporating vegetation can reduce these temperature impacts. Heat can be reflected back into the atmosphere by using reflective or light-colored surfaces, and vegetation can be planted that evapotranspires water and thereby cools the ambient air temperatures (USEPA 2008). Table 1-3 compares albedos (how reflective or bright an object is) of different materials. A higher albedo reflects more light and helps with cooling.

Table 1-3. Albedos for various reference materials

Material	Albedo
Concrete (new to aged)	0.2 – 0.35
Asphalt (new to aged)	0.05 – 0.2
Deciduous plants	0.20 – 0.30
Dry grass	0.30
Deciduous woodland	0.15 – 0.20
Coniferous woodland	0.10 – 0.15
Artificial turf	0.05 – 0.10
Grass and leaf mulch	0.05

Source: Santamouris 2001; Pomerantz 2003.

Social Benefits of Green Streets



Offers Pedestrian Safety and Traffic Calming

Green infrastructure features, such as stormwater curb extensions, bump-outs and porous/vegetated islands, can be incorporated into street designs (e.g., placed in intersections or in the middle of cul-desacs) to help slow traffic, reduce crossing distances and increase awareness of crosswalk locations. Adding or enhancing sidewalks, crosswalks and bike lanes can contribute to greater public safety for all users. Pedestrian deaths account for 12 percent of total traffic deaths in the United States; these typically result from inadequate or nonexistent pedestrian safeguards such as crosswalks, pedestrian refuge islands (i.e., safe locations, such as a section of pavement or sidewalk within the roadway, where pedestrians can stop), and school and public bus shelters (TFA 2011).



Enhances Well-Being of Individuals

Green street practices can be placed in or along roadways and sidewalks to create safe and aesthetically pleasing pathways that encourage active transportation such as walking or biking. Planting trees creates shade and cools the air temperature so people are more likely to walk or bike. Green spaces have been shown to enhance the strength of social ties between neighbors (Holtan 2014). Neighborhoods with social cohesion have lower rates of social disorder, anxiety and depression. Green spaces enhance well-being and help the mind recover from mental fatigue or stress (Kaplan 1995). In densely developed urban areas, adding green infrastructure provides some relief in areas otherwise devoid of green infrastructure such as parks.



Increases Sense of Community

Although this benefit is often qualitative in nature, it reflects the ability of a feature such as a green street to positively serve as a signature place or a destination for community residents or visitors and/or a model for development or redevelopment (DC OP 2011). In stressed or underserved communities, greening efforts can serve to help brand or rebrand a community to attract investments and provide residents and visitors a new perspective about their community. Green street projects can also serve to help educate the community about environmental issues such as protecting watershed health, building neighborhoods' weather resilience and caring for nature. Potential measures for evaluating this benefit include:

- Anticipated increase in sales by nearby merchants
- The number of events held in the project area
- Number of tourists and visitors anticipated to visit the project location
- Increases in community investments
- Improved environmental awareness in local schools

For More Information—Social Benefits of Green Streets

[Cities Safer by Design: Guidance and Examples to Promote Traffic Safety through Urban and Street Design](#). World Resources Institute (2015)

[Imaging Livability Design Collection: A visual portfolio of tools and transformations](#). AARP Livable Communities and the Walkable and Livable Communities Institute (2015)

[Green Values Strategy Guide: Linking Green Infrastructure Benefits to Community Priorities](#). Center for Neighborhood Technology (2020)

Economic Benefits of Green Streets



Increases Property Values

Adding plants and trees to green streets creates attractive neighborhoods, which in turn can increase nearby property values by two to five percent (NRDC 2013). A research study evaluating street trees in Portland, Oregon, found that street trees added \$8,870 to a house's sale price—equivalent to adding 129 finished square feet (sq ft). By extrapolating street tree benefits across the entire city, the study calculated that the increased property value translated into an increased annual property tax revenue of \$13 million. Additionally, the benefits were found to outweigh the costs by almost 12 to 1. One study estimated the benefits created by green streets to be \$54 million annually, compared to the annual cost of \$4.61 million required to maintain the green street elements (Donovan and Butry 2010).



Reduces Water Treatment Costs

Green infrastructure practices that increase infiltration or use water on-site (e.g., bioretention systems, permeable surfaces) can reduce the amount of water being conveyed to wastewater treatment facilities and reduce combined sewer overflows (CSOs). Reducing the volume of water discharged to combined stormwater and sewer systems can reduce the need to treat significant volumes of runoff. Reducing intake volumes can also reduce the stormwater infrastructure needed to convey this volume of runoff. The avoided costs and resulting benefits of green infrastructure can be evaluated by determining the amount of stormwater that will be infiltrated or evapotranspired versus the costs of treatment and ongoing maintenance and management of the system. A study completed for the City of Lancaster, Pennsylvania, found that implementing their Green Infrastructure Plan could reduce wastewater pumping and treatment costs by approximately \$661,000 per year using the Center for Neighborhood Technology's methods for evaluating benefits of green infrastructure (USEPA 2014; CNT 2010).



Reduces Infrastructure Costs

In addition to avoided treatment costs, green infrastructure practices can also reduce gray infrastructure costs by reducing the need for infrastructure expansion, extending infrastructure life expectancies and decreasing overall life-cycle costs.

For example, the City of Lancaster study found that their Green Infrastructure Plan could cut capital costs for gray infrastructure by \$120 million—the estimated cost for reducing CSOs via gray infrastructure storage, such as a tunnel (USEPA 2014). In another study in West Union, Iowa, the life-cycle costs of a permeable paver system and a traditional concrete pavement in a parking lot were compared; the analysis showed that over the life of the project, savings could be close to \$2.5 million by selecting the permeable pavement (NRDC 2013). Although green infrastructure could have greater capital costs, the potential extended life of the system and avoided costs can provide significant savings when analyzed over a long life cycle.



Reduces Property Damage Due to Flooding

Lastly, green infrastructure practices can lessen the level of damage from flooding. Among the types of flooding that could become more frequent are localized floods and riverine floods. Localized flooding happens when rainfall overwhelms the capacity of urban drainage systems, while riverine flooding happens when river flows exceed the capacity of the river channel.

In areas impacted by localized flooding, green infrastructure practices can be used to absorb rainfall and reduce the amount of water that is discharged in stormwater systems, pools in streets, or seeps into basements (Qin 2013). In areas impacted by riverine flooding, green infrastructure, open space preservation, and floodplain management can all complement gray infrastructure approaches and reduce the extent of flood damage.

1.4 Additional Resources: Green Infrastructure

Numerous green infrastructure guidance and design manuals are available from online sources. As noted below, many have been tailored to represent the needs of particular regions of the country.*

West

- California (Los Angeles). [Development Best Management Practices Handbook](#)
- California (San Francisco). [Green Stormwater Infrastructure Typical Details, Appendix B of Stormwater Management Requirements and Design Guidelines](#)
- California (San Mateo County). [Green Infrastructure Design Guide](#)
- California. [San Francisco Stormwater Management Requirements and Design Guidelines](#)
- Colorado (Denver). [Ultra-Urban Green Infrastructure Guidelines](#)
- Oregon. [Low Impact Development Approaches Handbook](#)
- Oregon (Portland). [Stormwater Management Manual includes Green Street Typical Details](#)
- Washington (Puget Sound). [Integrating LID into Local Codes: A Guidebook for Local Governments](#)
- Washington (Seattle). [Streets Illustrated: Right-of-Way Improvements Manual](#)

Southwest

- Arizona. [Green Infrastructure for Southwestern Neighborhoods \(Spanish version\)](#)
- Arizona (Mesa). [Low Impact Development Toolkit](#)
- Arizona (Pima County). [Low Impact Development and Green Infrastructure Guidance Manual](#)
- Texas. [San Antonio River Basin Low Impact Development Technical Guidance Manual](#)

Midwest

- Illinois (Chicago). [Green Alley Handbook](#)
- Michigan. [Great Lakes Green Streets Guidebook](#)
- Michigan. [Low Impact Development Manual for Michigan](#)
- Minnesota (North St. Paul). [Living Streets Plan](#)
- [Minnesota Stormwater Manual](#)
- Missouri (Kansas City). [Green Stormwater Infrastructure Manual](#)
- Nebraska (Omaha). [Green Streets Plan for Omaha](#)

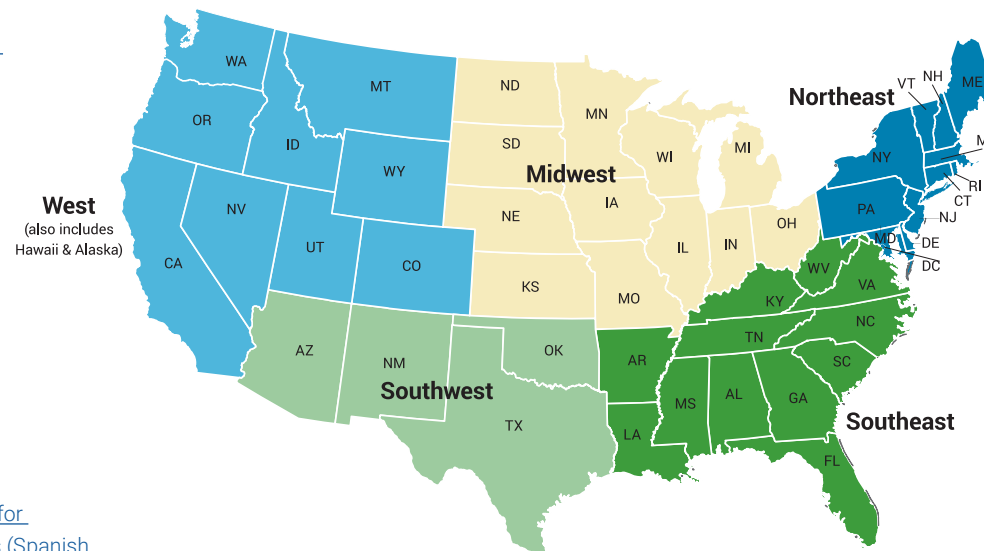

Northeast

- District of Columbia. [Greening DC Streets: A Guide to Green Infrastructure in DC](#)
- [Maryland Stormwater Design Manual](#)
- Massachusetts (Holyoke). [Green Streets Guidebook](#)
- Pennsylvania. [Philadelphia Green Streets Design Manual](#)
- [Rhode Island Low Impact Development Site Planning and Design Guidance Manual](#)

Southeast

- Kentucky (Louisville). [MSD Design Manual, Ch. 18 Green Infrastructure](#)
- North Carolina. [Stormwater Design Manual](#)
- Tennessee (Nashville). [Low Impact Development Stormwater Management Manual](#)

* The map includes a sample of resources available; it does not represent all potential references that might be available from states and territories across the nation.

2 Transportation Typologies and Green Infrastructure Practices

In This Chapter

- 2.1 Transportation Typologies
- 2.2 Arterials
- 2.3 Collector Roads
- 2.4 Local Roads
- 2.5 Alleys
- 2.6 Parking Lots
- 2.7 Identifying Opportunities for Green Infrastructure Placement
- 2.8 Reconfiguring Designs to Create Space for Green Infrastructure Practices

This chapter covers how green street concepts can be applied to different road classification systems, or transportation typologies, including arterial roads, collector roads, local roads, alleys and parking lots. Each typology is suitable for many different types of green infrastructure practices, from bioretention to bioswales to permeable pavements. Existing roadways also provide many opportunities for green infrastructure, including in verge zones along highways, in parking lanes, and in median spaces or planting areas of parking lots.



Sidewalk planters capture runoff from a local road in Emeryville, CA.

2.1 Transportation Typologies





This handbook addresses typical low impact development and green infrastructure strategies that can be incorporated into public and private projects within rights-of-way that are part of a private development or are owned or maintained by a state, county, or municipal department of transportation (DOT).

The Federal Highway Administration’s (FHWA’s) road classification system, or transportation typology, defines roads based on specific function or purpose: **arterial**, **collector** and **local**. At the local level, additional sub-classes often include **alleys** and **parking lots** (Table 2-1).

Many cities further categorize streets according to land use context, neighborhood characteristics and other special considerations to recognize the scope of activities that occur along the street, such as:

- Parkway
- Main street
- Industrial thoroughfare
- Commercial (small, medium, large)
- Downtown historic corridor
- Shopping district
- Transitway
- Neighborhood/residential street

Table 2-1. Transportation category descriptions¹

Transportation category	Description	Examples	Users
Arterial roads	Fast-moving, high-traffic roads for vehicular travel between and around urban areas. These roads typically have several travel lanes (two to four).	Interstates and highways	
Collector roads	Moderate-traffic roads that serve high-density areas, including residential, mixed use and neighborhood business districts. Speed limits and traffic volumes depend on adjacent land use. These roads offer some connections to individual parcels and driveways.	Avenues, boulevards and parkways	
Local roads	Low-traffic roads with slow speeds that serve residential areas. Many connections to individual parcels and driveways. These roads typically have one or two travel lanes, slower speed limits and low traffic volumes.	Road and streets	
Alleys	Low-traffic roads that provide access to areas adjacent to or behind buildings and residences.		
Parking lots	Areas that provide multiple parking spaces.		

¹ Modeled after FHWA functional classifications

Road Usage Influences Management Approach

To avoid compromising safety and disrupting access and mobility, a road's classifications and the context of the road project should be considered when determining where to site practices (Figure 2-1). The specific strategies and technologies implemented will vary depending on the following transportation system characteristics:

- Road usage types
- Traffic volumes
- Specific project conditions
- Adjacent land uses
- Contributing drainage area
- Available space
- Site characteristics (e.g., slope, soils, infiltration capacity)

Sections 2.2–2.6 discuss the type of practices that are typically appropriate for the various road classifications.

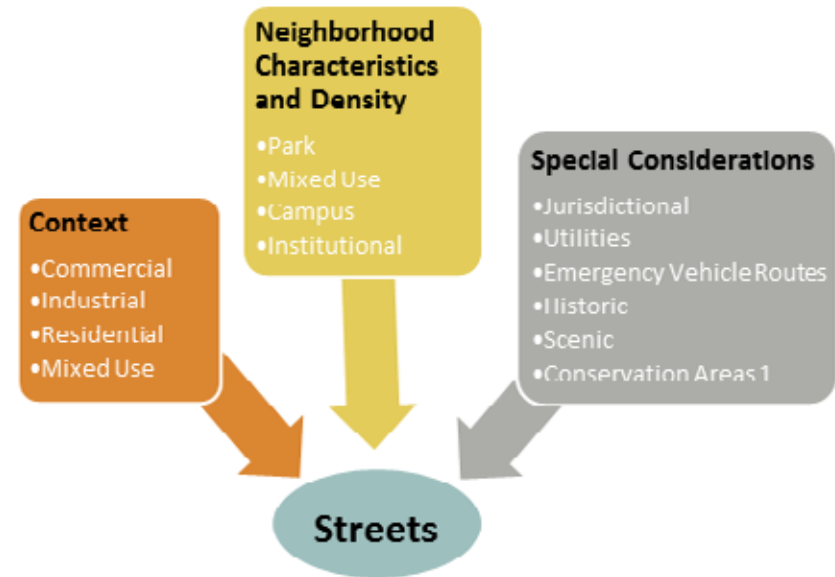

Figure 2-1. Numerous factors must be considered when choosing and siting green infrastructure practices as part of a green street design.

For More Information—Road Classification

[Highway Functional Classification Concepts, Criteria and Procedures, Section 3](#), U.S. Department of Transportation (2013)



Highway.



Downtown business area.



Neighborhood/residential street.

Road Usage Influences Choice of Projects

A variety of site design strategies and green infrastructure practices are appropriate for developing green streets. Table 2-2 provides a quick reference for screening practices that could be appropriate for the transportation typology or application being considered.

More detailed descriptions of practices appropriate for each of these road typologies are outlined in the following sections. Key design features for each of these practices are discussed in Chapter 4. Specific technical information for each practice type is provided in Chapter 6.

It should be noted that, in general, most of the green infrastructure practices in this handbook provide the same basic stormwater functions, but the shape of the practice (depth, width, geometry) will differ based on the site and geotechnical factors. For example, bioretention cells and stormwater curb extensions manage stormwater in a similar manner, but their construction and optimal site locations are different.

The practices in this handbook were chosen because they can be implemented in a variety of projects, ranging from narrow rights-of-way to urban sidewalks to highway shoulders. Additional practices not included in this handbook might also be appropriate in certain applications. Some of the resources listed within the chapters and in the reference section cover these practices.

For More Information—Roadway Rating Systems

Incorporating green infrastructure is just one element to consider when developing sustainable roadways. Other important factors include the types of materials and resources used, the operation and maintenance needs, and energy and atmosphere impacts. Several states and other third parties have developed scorecards to encourage transportation departments to address these topics. Some of these certification and rating systems include:

- [Federal Highway Administration INVEST tool](#)
- [Illinois – Livable and Sustainable Transportation Rating System and Guide](#)
- [New York State Department of Transportation GreenLITES \(Green Leadership in Transportation Environmental Sustainability\)](#)
- [Greenroads](#) Rating System (\$)
- [Institute for Sustainable Infrastructure](#) (Envision rating system)
- [EPA Guide to Sustainable Transportation Performance Measures](#) (2011)

Table 2-2. Guide for screening green infrastructure practices for different transportation typologies

Green Infrastructure Practices for Roadways and Parking Lots								
<ul style="list-style-type: none"> ● Most appropriate ◐ Depends on site context ○ Least appropriate 	Bioretention	Bioswale	Stormwater curb extension	Stormwater planter	Street trees	Infiltration trench	Subsurface infiltration and detention	Permeable pavement
Arterial	◐	●	○	○	●	◐	○	●
Collector	●	◐	●	●	●	◐	●	◐
Local roads	●	◐	●	◐	●	◐	○	◐
Alleys	○	○	○	○	○	◐	●	●
Parking lots	●	●	◐	●	●	◐	●	◐

2.2 Arterials

Arterials are roads that carry through-traffic between major urban areas or between the central business district and outlying residential areas. These roads generally have higher speeds and more traffic lanes than most other street types. Arterial roads are primarily designed for vehicular transit and are heavily used by trucks; however, some accommodations are made to improve accessibility when the road passes through urban areas.

Subcategories for arterials are called major and minor. Minor arterials serve smaller geographic areas, provide service for trips of moderate length and might have minimal connection to adjacent parcels as compared to a major arterial. In urban areas, minor arterials may carry local bus routes. These distinctions are helpful in identifying the types of users from which design decisions regarding lane widths can be determined. The minimum

desired lane width determines the amount of right-of-way potentially available for other uses such as stormwater management or bicycle lanes.

The linear stretches of land alongside an arterial road provide opportunities for siting green infrastructure practices and treatment trains. The selection of practices is limited by the amount of available area, soil characteristics, existing topography and roadway safety requirements. A common challenge is the presence of compacted soils, which is typically the result of construction-related grading activities. Because of potential compaction issues, infiltration rates should be tested beforehand. If necessary, soil should be modified (i.e., by adding soil amendments) to meet design standards. Using pretreatment devices such as swales and buffer strips is highly recommended to reduce sediment loads and runoff volumes and



A bioretention area is located adjacent to an arterial road along the Schuylkill River in Philadelphia, PA.

USEPA



A bioretention area located in the median of an arterial road captures runoff in the Great Lakes region.

U.S. Geological Survey

maintain long-term infiltration rates. Green infrastructure practices are typically suitable in three main arterial road zones (Table 2-3):

- When present, **medians** are an ideal location for linear practices such as bioswales and infiltration trenches. Bioretention cells might be applicable depending on the amount of available area. Reforestation is an option if the median is large enough and the trees do not obstruct drivers' lines of sight or interfere with utilities.
- **Shoulders and breakdown lanes** of a road can be good locations for permeable pavement or open-graded friction course overlays (see Chapter 4.12) because traffic is slow and use is low. An open-graded friction course spreads flow, reduces splashing and maximizes infiltration. It also improves safety by reducing hydroplaning and light reflectivity off the road surface.
- The **verge**, the area adjacent to a roadway, can be ideal for linear practices such as bioswales, infiltration trenches and tree canopy enhancements. Trees require ample open space and should not obstruct drivers' lines of sight or be a collision safety hazard. Low-growing vegetation might be the best choice for curving roadways.



Alisha Goldstein

Medians with rain gardens manage stormwater runoff from the street collected via stormwater inlets connected to subsurface pipes in Arlington, VA.

Table 2-3. Suitability of green infrastructure practices for arterial road zones

<ul style="list-style-type: none"> ● Most appropriate ◐ Depends on site context ○ Least appropriate 	Medians	Shoulder and/or breakdown lanes	Verge
Bioretention	●	○	●
Bioswale	●	○	●
Stormwater curb extension	○	○	○
Stormwater planter	○	○	○
Street trees	●	○	●
Infiltration trench	●	○	●
Subsurface infiltration and detention	○	○	○
Permeable pavement/open graded friction course	○	◐	○



Low Impact Development Center

Road runoff will be treated by this bioswale in the median of Adelphi Road, an arterial road in Maryland.

2.3 Collector Roads

Collector roads serve to funnel traffic from local roads to other local roads or arterials. They have high traffic volumes and multiple travel lanes (two or three). These roads often serve as routes for public transit and must provide adequate pedestrian facilities to allow safe and comfortable access and waiting areas. They offer some connections to individual parcels and driveways, and they can include on-street parking and shared bike lanes.

Collectors in mixed-use or neighborhood business districts tend to have slower speed limits to accommodate pedestrians. The addition of green infrastructure practices can also enhance pedestrian safety. For example,

placing stormwater curb extensions at intersections or near crosswalks can calm traffic and alert drivers to pedestrian activity. Additionally, extensions can decrease the crossing distance, enabling pedestrians to safely cross streets.

Figure 2-2 illustrates a collector road through a neighborhood business district. The placement and types of green infrastructure practices that are feasible along collectors are denoted in the legend. As shown on the next page, a street's configuration might also influence the selection of particular practices.



Figure 2-2. A collector road with green infrastructure features in a neighborhood business district.

Implementing green infrastructure practices in urban areas—especially in the right-of-ways on collector roads—is often challenging because less space is available and a utility conflict is more likely. In areas with high pedestrian traffic, practices with a smaller footprint or designs that preserve walkway width are more desirable. Green infrastructure practices are typically suitable in three main collector road zones (Table 2-4):

- **Medians and rights-of-way** are ideal for linear practices like bioswales and infiltration trenches. Collector roads without high pedestrian traffic might be better suited for bioswales, which often require more surface area and can handle large runoff volumes. Wide medians might also be appropriate for bioretention cells.
- **On-street parking areas, bike lanes or sidewalks** are best suited for permeable pavement, especially in dense urban areas where space for multimodal uses is at a premium. If space allows, stormwater planters can be used to separate a bike lane from a driving lane. Stormwater curb extensions can be placed mid-block or at the intersection of a parking lane. Maintenance needs should be planned and budgeted in advance.
- **Collectors with curbs and sidewalks** are appropriate locations for stormwater curb extensions, stormwater planters and street trees. These practices should only be installed where sidewalk width will

support pedestrian traffic and horizontal and vertical space is available to accommodate tree growth. Suspended pavement designs that support the weight of paving and allow soil beneath to remain uncompacted can help provide sufficient soil volume for trees. Street trees help define the road boundary, protecting both pedestrians and motorists.

Table 2-4. Suitability of green infrastructure practices for collector road zones

<ul style="list-style-type: none"> ● Most appropriate ◐ Depends on site context ○ Least appropriate 	Medians	Bike or parking lanes	Verge
Bioretention	●	○	●
Bioswale	●	○	●
Stormwater curb extension	○	◐	●
Stormwater planter	○	◐	●
Street trees	●	○	●
Infiltration trench	●	○	◐
Subsurface infiltration and detention	○	◐	◐
Permeable pavement	○	◐	◐



Ann Rossi, USEPA

Bioswale separates sidewalks from bike lanes and vehicular traffic in Indianapolis, IN.



Alisha Goldstein

Permeable pavement parking lane in downtown Syracuse, NY.



Eric Vance, USEPA

Bioretention cell in sidewalk with seating along a commercial corridor in Washington, DC.

2.4 Local Roads

Local roads are low-traffic roads predominant in neighborhood areas. Because they serve residences, local roads could have a high pedestrian presence, sidewalks and shared bike lanes. There will be significant on-street parking for residents. Local roads account for the largest percentage of roadways in terms of total road miles (USDOT 2013).

Figure 2-3 illustrates the placement and types of green infrastructure practices that are appropriate along local roads. Other opportunities for siting practices are described in more detail on the following page.



Figure 2-3. A local road with green infrastructure features in a neighborhood area.

Many of the green infrastructure practices recommended for collector roads also apply to local roads; however, local neighborhood characteristics should be considered as part of the decision-making process. Sufficient sidewalk widths and adequate separation from vehicular traffic should be maintained to preserve safety and comfort for pedestrians. Depending on the design, introducing green infrastructure can enhance pedestrian safety.

Green infrastructure practices are typically suitable in the rights-of-way or bike or parking lanes of local roads (Table 2-5). When choosing specific practices, consider the site's stormwater management characteristics:

- Practices applicable to **roads with curbs** include stormwater curb extensions, stormwater planters, tree pits and tree trenches, and bioswales. These practices require curb cuts or inlets to direct stormwater to the practice from the street.
- **Roads without curbs** are more commonly associated with bioretention and bioswales when sufficient area exists to locate these practices without infringing on vehicular or pedestrian traffic. These practices depend on sheet flow to convey runoff.

Table 2-5. Suitability of green infrastructure practices for local road zones

<ul style="list-style-type: none"> ● Most appropriate ◐ Depends on site context ○ Least appropriate 	Bike or parking lanes	Right of way
Bioretention	○	●
Bioswale	○	●
Stormwater curb extension	◐	●
Stormwater planter	○	○
Street trees	○	●
Infiltration trench	○	◐
Subsurface infiltration and detention	◐	○
Permeable pavement	◐	◐



Pervious concrete pavement on a low-speed residential roadway in Shoreview, MN.



Stormwater curb extension installed with a sidewalk project in Maplewood, MN.

2.5 Alleys

Alleys have many connections to individual parcels and driveways, and they usually provide access for commercial deliveries, waste collection, access for emergency vehicles and parking. It is important to preserve right-of-way access for larger vehicles. Permeable pavement is an ideal practice for alleys because the drainage area is small and amount of sunlight reaching the ground is often limited (which can be a factor preventing the use of vegetated practices). Other appropriate practices include infiltration trenches and subsurface infiltration and detention (Table 2-6).

Table 2-6. Suitability of green infrastructure practices for alleys

<ul style="list-style-type: none"> ● Most appropriate ● Depends on site context ○ Least appropriate 	Alleys
Bioretention	○
Bioswale	○
Stormwater curb extension	○
Stormwater planter	○
Street trees	○
Infiltration trench	●
Subsurface infiltration and detention	●
Permeable pavement	●

For More Information—Green Alleys

[Chicago Green Alley Handbook](#). City of Chicago, IL (2010)

[Green Streets and Green Alleys Design Guidelines Standards](#).
City of Los Angeles, CA (2009)

[Green Alley: Urban Street Design Guide](#). National Association of
City Transportation Officials.



Abby Hall

Permeable asphalt alley in Chicago, IL.



Alisha Goldstein

Permeable paving in an alley in the Avalon neighborhood in Los Angeles, CA.

2.6 Parking Lots

Parking lots represent a good opportunity to incorporate green infrastructure into the layout, especially for new designs (Figure 2-4). Although retrofitting of parking lots might be expensive, it is often cost-effective to include green infrastructure practices when the parking lot is reconfigured or when the pavement is replaced or rehabilitated. Depending on the size of the parking lot and its use patterns, various surficial and subsurface practices can be incorporated into the design.

When designing new projects, site design principles aimed at minimizing effective impervious surface area should be evaluated before other practices are considered. Site design considerations include geometric layout, the number of parking spaces, the required dimensions of parking spaces and the direction of surface flow.



Image: Clean Water Services, Inc.

- Connect planters for greater capacity and/or to convey overflows to receiving drainage system
- Locate planters at end of parking aisles
- Overflow inlet
- Curb cuts
- Bioswales
- Porous paving drains to planters or bioswales
- Porous pavement

Figure 2-4. A parking lot with green infrastructure features (bioretention areas and street trees).

Green infrastructure practices should be designed with vehicle and pedestrian movement and safety in mind. Long linear practices should include pathways for pedestrians to cross without stepping on the practice. Practices must allow adequate room for motorists to safely exit their cars. Safety can be enhanced if practices are configured to serve as a buffer between vehicle travel lanes and pedestrians.

Stormwater management practices that include trees and large bushes can shade areas of impervious cover, providing heat mitigation benefits by reducing the effects of heat reflection and absorption. Shaded parking lots are also desirable for drivers who want to keep their vehicles cooler. Incorporating vegetation into practices can improve the visual aesthetic of a parking lot, making the establishment appear more welcoming.

Green infrastructure practices are typically suitable in parking bays, traffic islands and along the perimeter of parking lots (Table 2-7). Islands, parking bays and parking lot perimeters can be designed or retrofitted to include bioretention, bioswales, trees, infiltration trenches, street trees and subsurface infiltration/detention. Permeable pavement is most suitable for low-traffic, low-speed uses such as parking bays. Interlocking concrete pavers are more often used in high-load commercial and industrial settings. If cost or use patterns are a concern, consider using permeable pavement in the stalls and conventional pavement in the travel lanes. For an overflow parking lot with infrequent use, consider using grass pavers or concrete-grid gravel pavers instead of pavement.

For More Information—Parking Lot Design

[Design Guidelines for 'Greening' Surface Parking Lots](#). City of Toronto, Canada (2013; email for copy)

[Green Parking Lot Resource Guide](#). USEPA (2008)

[LID Parking Lots: Technical Assistance Memo](#). California Water Quality Regional Control Board

[Sustainable Green Parking Lots Guidebook](#). Montgomery County Planning Commission, PA (2015)

Table 2-7. Suitability of green infrastructure practices for parking lots

	Medians	Traffic islands	Perimeter or parking bays
● Most appropriate			
○ Depends on site context			
○ Least appropriate			
Bioretention	●	●	●
Bioswale	●	○	●
Stormwater curb extension	○	○	○
Stormwater planter	●	○	●
Street trees	●	●	●
Infiltration trench	●	○	●
Subsurface infiltration and detention	○	○	●
Permeable pavement	○	○	○



Permeable pavers installed at the downgradient end of parking bays collect surface runoff and allow it to infiltrate.

Low Impact Development Center

2.7 Identifying Opportunities for Green Infrastructure Placement

Road Type Influences Rights-of-Way Zone Usage

Depending on their use categories, street and parking lot rights-of-way can be divided into zones such as travel lanes, parking lanes, curb zones/shoulders, throughway zones/pedestrian areas and store frontage zones. The width allotted to each zone is a critical aspect of street design; width influences traffic speeds, access for multiple users, and overall user comfort and safety. The road's use classification and location will influence whether the right-of-way zones are designed to emphasize benefits for pedestrians or vehicles (Figures 2-5 and 2-6).

Decisions for travel lane widths are based on transportation typology and context; however, traffic calming goals and desired use also should be considered. Travel lane width has been shown to impact traffic speeds: wider travel lanes are correlated with higher vehicle speeds (Fitzpatrick 2000). By reducing the street width, traffic speeds decline and space in the right-of-way becomes available for other purposes, such as the placement of green infrastructure practices.

Rights-of-way offer many opportunities for siting of green infrastructure practices, as depicted by the orange shaded areas on the photos on the next page. As shown in Figure 2-7, the rights-of-way between sidewalks, bicycle lanes and the vehicle travel lanes can be ideal sites for a storm-water planter. Similarly, green elements can be incorporated into long roadside zones (Figure 2-8) or parking areas (Figure 2-9), or in smaller spaces such as unused triangles at the intersection of diagonal streets (Figure 2-10).

For More Information—Road Retrofits

[Grey to Green Road Retrofits](#). Credit Valley Conservation, Canada (2014)

[Municipal Handbook: Green Infrastructure Retrofit Policies](#). USEPA (2008)



Alisha Goldstein

Figure 2-5. In this setting, pedestrian-friendly zones have a relatively high amount of space in the right-of-way relative to the size of the street.

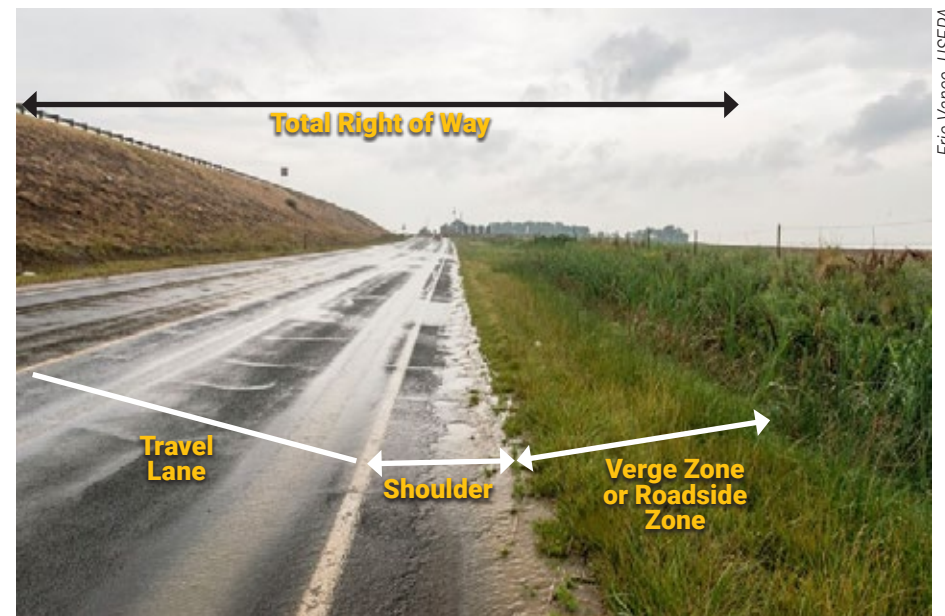

Eric Vance, USEPA

Figure 2-6. In this setting, the right-of-way zones are geared toward vehicles.

Existing Roadway Rights-of-Way Offer Available Space for Green Infrastructure

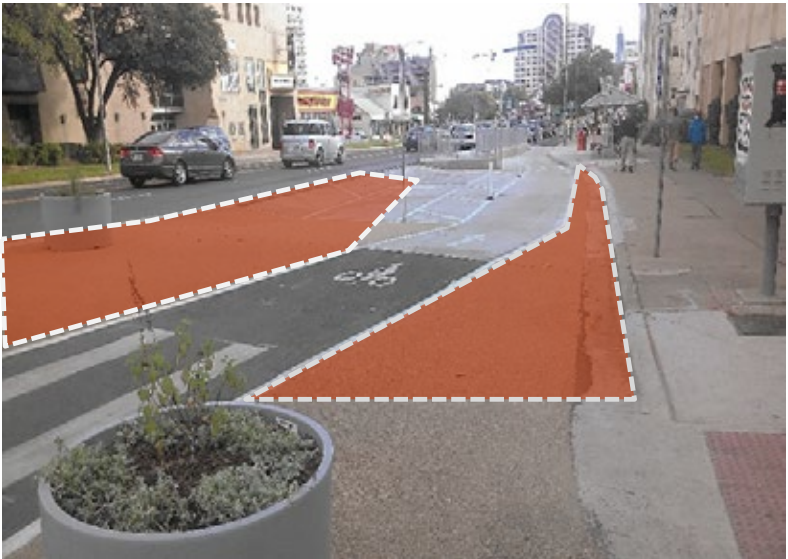

Alisha Goldstein

Figure 2-7. Adding a buffer, such as a stormwater planter, between modes of transportation can control stormwater and improve safety.



Eric Vance, USEPA

Figure 2-8. Green elements such as a swale, permeable pavement or a permeable friction overlay can be added in the verge area (roadside zone).



Alisha Goldstein

Figure 2-9. Alternative surfaces such as permeable pavement can be used in on-street parking lanes.



Alisha Goldstein

Figure 2-10. Green infrastructure practices can be incorporated into unused space at the intersection of diagonal streets.

Existing Parking Lot Designs Can Accommodate Green Infrastructure

Parking stall dimensions are typically mandated by local zoning ordinances and are determined with respect to car size and frequency of vehicle turnover. Existing space in parking lots can often be filled with green infrastructure practices while preserving the same number of parking spaces.

For example, an existing parking lot island surrounded by a curb can be retrofitted to include a bioretention feature (Figures 2-11 and 2-12). Similarly, by adjusting the length or placement of the parking stall, space can be made available to add a swale either in a median between facing stalls or around the perimeter of the lot (Figures 2-13 and 2-14). Stall widths can also be varied in the same lot to accommodate green features. High-turnover stalls nearest to the establishment can be built wider than stalls farther away, creating room for green infrastructure without reducing the number of available parking spaces.



Alisha Goldstein



Alisha Goldstein

Figure 2-11. This conventional parking lot island could be retrofitted for green infrastructure features.

Figure 2-12. A parking lot island includes a bioretention feature in Maplewood, MN.



Alisha Goldstein

Figure 2-13. In this parking lot the impervious median space between facing parking stalls could be retrofitted to infiltrate runoff.



Tetra Tech, Inc.

Figure 2-14. In this parking lot the median space between facing parking stalls includes a bioretention area.

2.8 Reconfiguring Designs to Create Space for Green Infrastructure

Reconfiguring roadways offers opportunities to create new space for green infrastructure. FHWA uses the term “Road Diet” to describe this practice, which is a high-value, low-cost way to improve safety and enhance a street’s overall functionality. Roadway reconfiguration projects typically include removing a lane and/or reducing lane width. A classic Road Diet involves converting an existing four-lane, undivided roadway segment to a three-lane segment consisting of two through lanes and a center, two-way left-turn lane (Figure 2-15).

A Road Diet can provide space that can be reclaimed for other uses such as bus lanes, bike lanes, bus shelters and green infrastructure features. These stormwater management features can be built in conjunction with pedestrian refuge islands or as safety/crossing barriers between motorists and pedestrians—achieving multiple benefits.

In 2014 the City of Lancaster, Pennsylvania, completed an award-winning retrofit of a dangerous intersection (Figure 2-16). The project removed a designated turn lane and added green elements, including permeable paver parking areas and patios, curb extensions and rain gardens, and a cistern that captures stormwater from the roof of a brewery adjacent to the intersection. The project calmed traffic and increased pedestrian safety by narrowing the traffic lane, while also offering aesthetic enhancement and patio space for the brewery. Research indicates that these types of roadway reconfigurations are likely to reduce accident rates (TRB 1990).

When a Road Diet is planned in conjunction with roadway reconstruction or simple overlay projects, safety and operational benefits often can be implemented at low cost (i.e., the cost of restriping the road). Incorporating green street elements should be considered when the overall design of the street is being changed or utilities are being installed or upgraded. Chapter 3 discusses how to select appropriate green infrastructure practices.

For More Information—Road Diets

[Road Diet Informational Guide](#), Federal Highway Administration (2014)

[Road Diets \(Roadway Reconfiguration\)](#), Federal Highway Administration

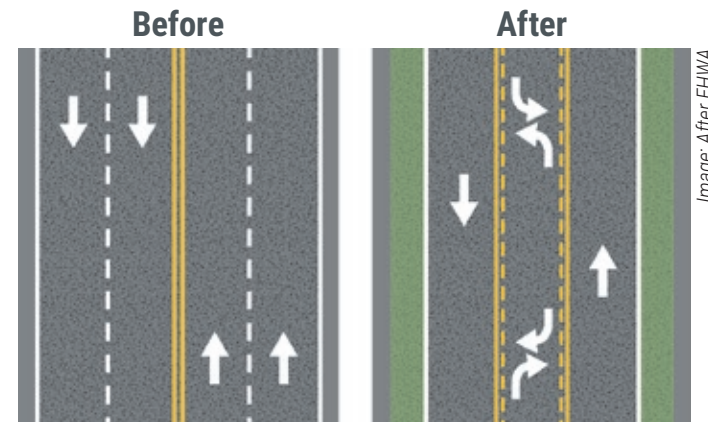
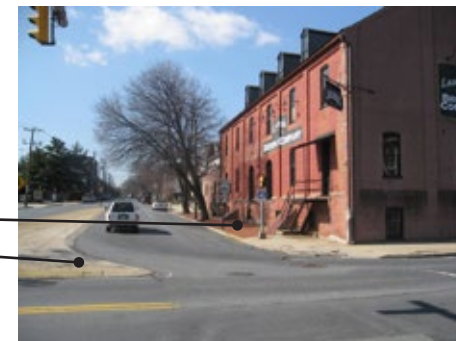

Figure 2-15. This simple road diet shows how two travel lanes are removed and replaced with one turn lane and two areas that could support green infrastructure practices.

Before

Narrow sidewalk
Impervious areas



After

Permeable parking
Rain garden
Permeable patio



Figure 2-16. A roadway was reconfigured to replace a turn lane with green infrastructure practices in Lancaster, PA.

3 Developing a Green Streets Program: A Process Overview

In This Chapter

- 3.1 Programmatic Process Overview
- 3.2 Establish Objectives
- 3.3 Identify Priority Area(s)
- 3.4 Characterize Sites
- 3.5 Develop a Stormwater Plan
- 3.6 Engage Community Partners

This chapter covers the process to develop a green streets program, beginning with establishing objectives, identifying priority areas, characterizing the sites and developing a stormwater plan. A green street stormwater plan will help you identify site constraints and opportunities, calculate impervious areas and runoff volumes, select appropriate green infrastructure practices, and consider costs. An effective green street program will also engage community partners in the process.

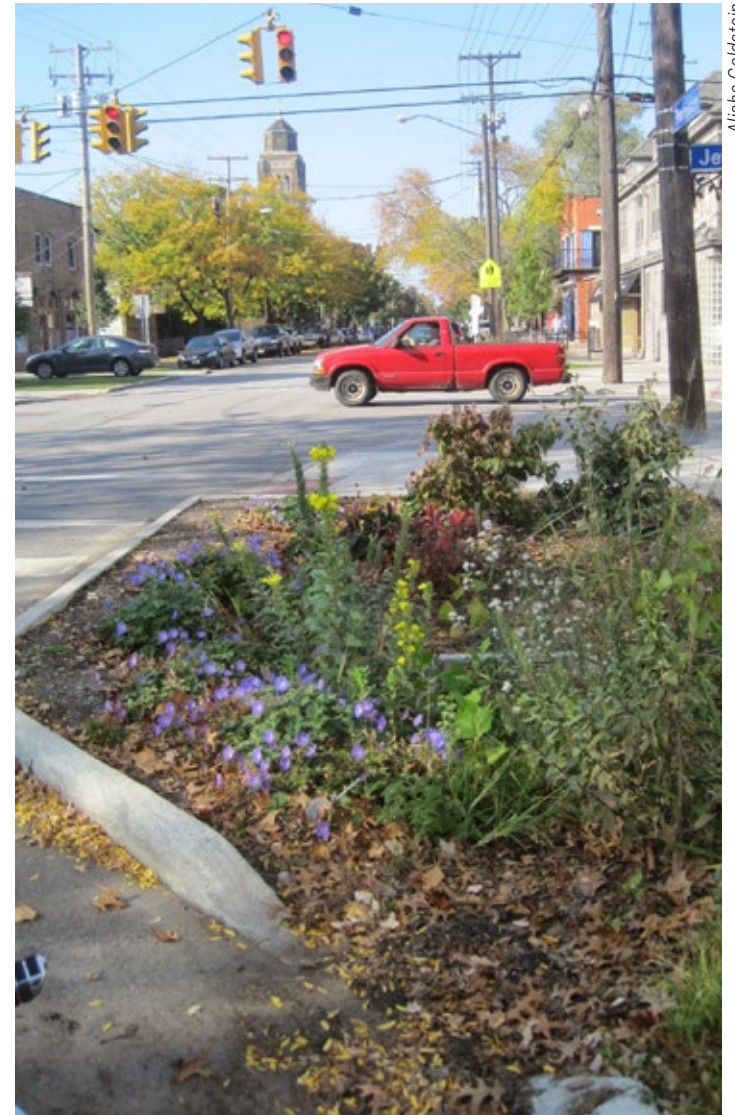

Alisha Goldstein

Traffic calming and stormwater bioretention curb bump-out project, Cleveland, OH.

3.1 Programmatic Process Overview

Pursuing a green street program requires consideration of various tasks as noted in Figure 3-1. The programmatic process is presented in a linear fashion, but when retrofitting existing transportation networks, steps may be completed in a different order or concurrently. For example, if a

street repaving project is under way, then the priority area has already been established and the objective(s) and a site characterization should be determined. A discussion of each task is provided in other areas of this handbook as denoted by the referenced section number.

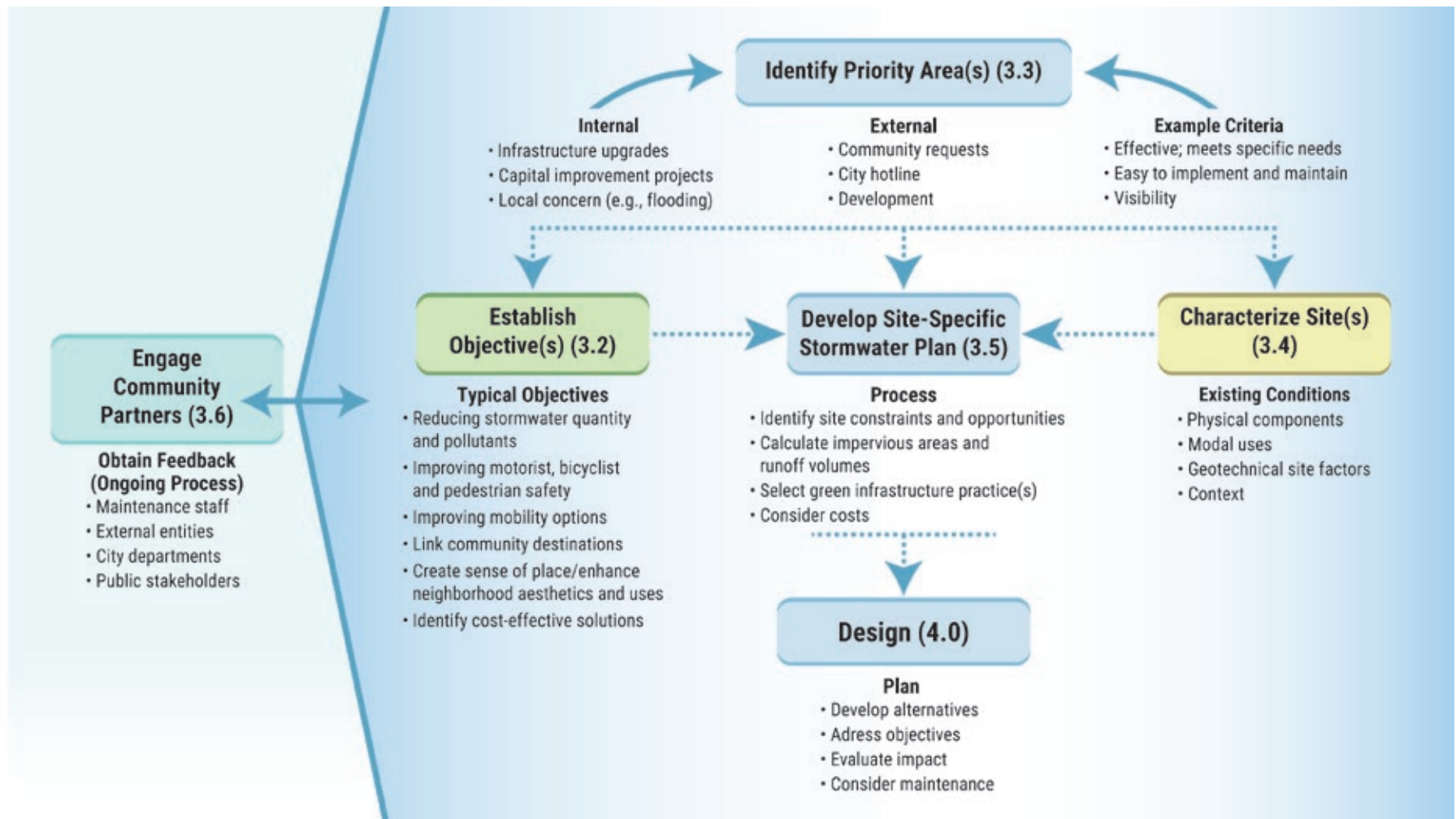

Figure 3-1. Recommended programmatic process for pursuing a green streets program.

3.2 Establish Objectives

Designing green streets requires a multifaceted approach to creating livable and aesthetically pleasing spaces. The following program objectives are commonly used to help justify a green streets program:

- **Stormwater control.** DOTs must often address regulatory requirements for stormwater runoff quantity and quality from streets (including MS4 permits, flooding, impaired waters, replacing aging infrastructure, etc.). Green streets can address multiple regulatory requirements in a single design.
- **Safety.** Green street designs can improve motorist, bicyclist and pedestrian safety by adding practices that slow traffic (curb bump-outs), adding separate bike lanes, and providing clear and separate areas for pedestrians and pedestrian crossings.
- **Access and mobility.** Green streets can be designed to offer multiple transit options or designed to improve access for bus, bikes and pedestrians. For example, dedicated bike and bus lanes can be integrated into a green street design to ensure dedicated access.
- **Context.** Context refers to the project’s physical, economic and social setting. Green streets can help improve community cohesiveness, ecological function, aesthetics and transportation system efficiency.
- **Livability.** Green streets can improve community livability by increasing tree canopy cover and vegetated practices. Livability can also be improved by increasing walkability and access for bikes.
- **Cost-effectiveness.** Adding green infrastructure can reduce overall costs when compared to the construction and maintenance of traditional stormwater infrastructure.

Before embarking on a project, it is advisable to establish goals and objectives that can be easily communicated to the public and be used to measure success (examples are in Table 3-1). Early engagement of stakeholders (see section 3.6) is critical to securing participation and buy-in from the public and other agencies.

Table 3-1. Example objectives of a green streets program

Focus area	Objective
Stormwater control	– Identify priority watersheds and project opportunities
Safety	– Improve pedestrian safety at crosswalks
Access and mobility	– Balance multiple modes of transport
Context	– Create linkages between community destinations
Livability	– Explore opportunities to promote streets for additional uses (e.g., adding bike lanes)
Cost-effectiveness	– Reduce construction and maintenance costs



Jason Wright, Tetra Tech, Inc.

Stormwater control, safety and livability are among the objectives fulfilled by these green infrastructure practices in Greensboro, NC.

3.3 Identify Priority Area(s)

Priority areas can be selected on the basis of a site-specific need or by using established objectives (see section 3.2) to screen potential project sites. Priority area selection can be influenced by the municipality's internal priorities (e.g., needed infrastructure upgrades, upcoming capital improvement projects, existing localized problems such as flooding) or requests from external sources (request submitted by communities or through a hotline, planned development). For example, repeated traffic accident reports (internal) or a request from a community member (external) could influence a decision to retrofit an intersection for safety reasons. Similarly, redevelopment projects that impact rights-of-way could be routinely evaluated as part of the review process to determine opportunities to add green infrastructure practices.

Existing municipal stormwater management plans, capital improvement projects, weather resiliency plans, or citywide initiatives can be used to help identify potential green infrastructure sites. A stormwater plan can identify neighborhoods that have flooding issues that could benefit from widespread implementation of green infrastructure practices. The development of a new stadium, a commercial development, or a street expansion project represent opportunities to "green" public rights-of-way and more effectively manage runoff.

Once a list of projects has been compiled, the projects should be scheduled for implementation based on criteria selected for prioritizing projects, such as need, cost, public demand, etc. When a community is initiating the use of green infrastructure practices, selecting highly visible projects with a high probability of success often helps to garner public acceptance of green infrastructure because successful projects can create support or demand for similar projects within the jurisdiction.



Horsley Witten

To improve safety, curb bump-outs were added to the corners to decrease the crosswalk distance and make pedestrians more visible to motorists.



Melissa Kramer

Signs help raise the visibility of a project by communicating why the stormwater feature was built and the benefits it provides.

3.4 Characterize Sites

Once goals and priority areas have been identified, a designer must assess the site to determine which green infrastructure practices are appropriate for the site conditions. A base map can be a useful tool for determining site constraints and other factors that might influence the choice of certain green elements (Figure 3-2). The site assessment should include physical, modal, geotechnical and contextual analyses (Figure 3-3). Conducting site visits is recommended to ensure the accuracy of the existing data, especially if time has lapsed since the information was surveyed.

The results of the site characterization can help identify factors (e.g., the presence of underground utilities, high or low soil infiltration rates, or land use patterns and citizen behaviors) that might influence whether a given practice is appropriate for the site, given programmatic objectives, performance requirements, available funding or maintenance concerns.

For example, infiltrative capacity can determine whether a curb bump-out must have an underdrain or be designed as a flow-through planter. The size of the available area and its contributing drainage area also will determine what practices are appropriate. Foot traffic, sightlines, overhead utilities and maintenance requirements should also be considered. Design alternatives, however, can be used to compensate for some site factors as presented in Chapter 4.

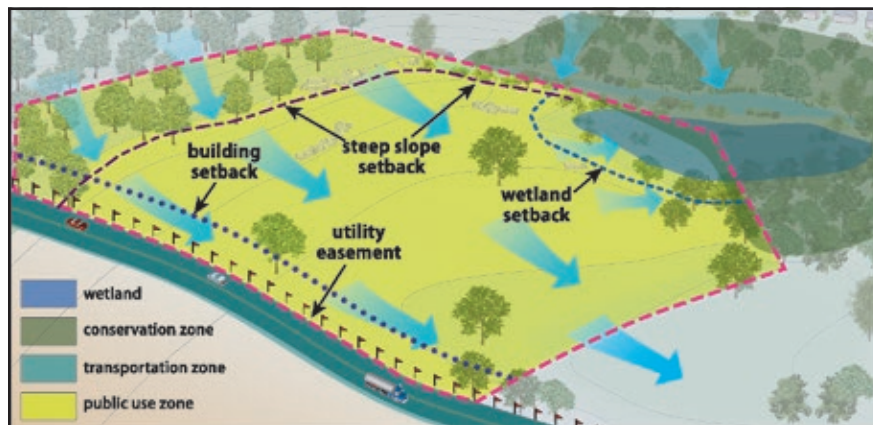

Figure 3-2. A base map indicates landscape and hydrologic features, necessary setbacks, existing easements and other components.

Image: Tetra Tech, Inc., after San Antonio River Authority

Physical Components	Modal Use
<ul style="list-style-type: none"> • Drainage area and flow paths • Utility locations (e.g., water, sewer, gas, electric) • Street grading and inlets • Existing stormwater infrastructure • Existing vegetation (especially mature trees) 	<ul style="list-style-type: none"> • Types of users • Circulation patterns • Traffic volume • Parking demands • Rights-of-way and lane widths • Pedestrian access points
Geotechnical	Context
<ul style="list-style-type: none"> • Topography and flow patterns • Soil borings logs <ul style="list-style-type: none"> – Description – Permeability – Depth to seasonal high groundwater table – Depth to bedrock • Possible sources of contamination • Floodplain 	<ul style="list-style-type: none"> • Neighborhood characteristics • Location of buildings and other structures • Loading and unloading zones • ADA-designated parking space • Land use • Master plan and zoning • Archaeological and cultural resources review

Figure 3-3. Types of analyses performed during a site assessment.

3.5 Develop Site-Specific Stormwater Plan

When developing a stormwater plan for a green street, several steps are necessary: (1) identify site constraints and opportunities, (2) calculate impervious areas and runoff volumes, (3) select green infrastructure practices, and (4) consider costs. (Note: a site-specific stormwater management plan is generally part of watershed plan, master plan or citywide stormwater plan that addresses larger management areas.)

Step 1. Identify site constraints and opportunities

First, identify opportunities in the rights-of-way, which might include medians, travel lanes, road shoulders, sidewalks and pathways, and slopes and drainage easements. Not all rights-of-way are appropriate for green infrastructure practices, however. Possible constraints should be assessed, which could include the width of the right-of-way, presence of utilities (above or below ground), roadway geometry and slope, proximity to storm drains, run-on stormwater flows, contributing drainage area, type of vehicular use, potential for pollution spills and high pollutant loads, ease of access for maintenance, reduced safety for pedestrians or vehicles, presence of bike and parking lanes, and cultural factors associated with the site.

Step 2. Calculate impervious areas and runoff volumes

Impervious areas associated with roads should be measured to calculate the volume of stormwater that runs off. Most state and local governments have specific requirements on how to calculate the stormwater design volume from impervious areas or the contributing drainage area(s).

Step 3. Select practices

Once the design volume is calculated, potential green infrastructure practices can be identified for specific locations. Chapter 2 includes examples of green streets for different street typologies. Chapter 6 provides information on the types of practices that are commonly used on green street projects.

Table 3-2. Relative costs for green infrastructure practices (per cubic foot of water)

● High ● Medium ○ Low	Capital	Operations and maintenance
Bioretention	○ ●	○ ●
Bioswale	○ ●	○ ●
Stormwater curb extension	●	○ ●
Stormwater planter	●	○ ●
Street trees	○ ● ●	○
Infiltration trench	○	○
Subsurface infiltration and detention	●	●
Permeable pavement	○	●

Sources: Clary et al., 2017; RTI and Geosyntec 2014

Step 4. Consider costs

Capital and operations and maintenance costs should be considered when selecting green infrastructure practices (Table 3-2). Costs will vary by location (i.e., site conditions or distance to material supplier), type of project (i.e., retrofit or new construction), and particular application and design specifications (i.e., required retention volume or depth of practice). Regional availability of expertise and supplies can also play a significant role in overall costs. Demand for green infrastructure can also create economies of scale that reduce material costs (e.g., in Chicago the cost of permeable pavement for alleys dropped significantly over the project period).

The costs for green infrastructure practices should be considered with respect to their ability to serve multiple functions, the benefits they provide and their anticipated life cycle. For example, practices such as permeable pavement, which serves both as a surface and a stormwater management practice, can save costs in a jurisdiction where stormwater management is required. By adding permeable pavement, the need for subsurface detention facilities, underdrains and related conveyance pipes can be reduced or avoided. Cost-benefit analyses and life-cycle assessments are useful methodologies for determining the costs of practices within a broader framework.

3.6 Engage Community Partners

Communication between all stakeholders should occur throughout the entire green street planning, design and implementation process. A dialog should be established with community residents, local business owners, and staff from public agencies or departments—especially agencies that need to maintain the green infrastructure or meet their own programmatic goals and objectives (e.g., landscaping or maintenance staff, fire and rescue services, planning and zoning departments).

Implementing a diverse outreach plan can ensure that stakeholders are made aware of projects, educated about the objectives and empowered to influence the outcomes. With the advent of social media, stakeholders can be engaged online through participatory surveys, interactive design tools, websites and other platforms. These methods could also be coupled with neighborhood open houses, door-to-door outreach and direct-mail marketing. To encourage discussion, some municipalities have developed planning scenarios for stakeholders to help them understand the potential impacts of such decisions. Outreach strategies should be ongoing throughout the process to give ample opportunity for feedback and to keep stakeholders up-to-date.

Guidelines to consider for community engagement, as adopted from [The Sustainable Communities Initiative](#) (Bergstrom et al. 2013), include:

- Be proactive and targeted in engagement strategies.
- Build clear opportunities for decision making and partnerships among community organizations.
- Prioritize community knowledge and concerns.
- Develop cultural competency skills and cultivate humility.
- Support capacity building to engage meaningfully.
- Engagement processes should include space to be iterative and reflective.
- Target resources to support ongoing engagement.

Conferring and coordinating with other entities early in the process helps to secure buy-in, increasing support for the project and possibly helping to procure matching funds and other financial resources for ongoing maintenance and rehabilitation of the practices. Identifying and coordinating green street implementation with other community improvement projects (see box) can reduce costs, improve functionality, and increase overall benefits and acceptance of green infrastructure.

Example Community Improvement and Green Infrastructure Collaboration Opportunities

- Bicycle, pedestrian, transit or greenway planning
- Urban forestry stewardship initiatives
- Safe Routes to School initiatives
- Emergency vehicles and routes
- Stormwater master planning
- Open space planning
- Street repaving projects
- Utility infrastructure improvements
- Capital improvement projects
- Community/private connections
- Climate change resiliency or sustainability designs

For More Information—Programmatic Process Elements

[Green Values National Stormwater Management Calculator \(Costs\)](#). Center for Neighborhood Technology (2009)

[Getting to Green: Paying for Green Infrastructure—Financing Options and Resources for Local Decision-Makers](#). USEPA (2014)

[Community Solutions for Stormwater Management: A Guide for Voluntary Long-Term Planning](#). USEPA (2016)

[Green Infrastructure in Parks: A Guide to Collaboration, Funding, and Community Engagement](#). USEPA (2017)

[Nonpoint Source Outreach Toolbox](#). USEPA

[Increasing Funding and Financing Options for Sustainable Stormwater Management](#). Center for Neighborhood Technology (2020)

4 Design Considerations

In This Chapter

- 4.1 Design Checklist
- 4.2 Selecting Appropriate Practices
- 4.3 Accommodating Utilities
- 4.4 Capturing Stormwater Runoff Types
- 4.5 Managing Stormwater Flow
- 4.6 Planning for Maintenance
- 4.7 Selecting Soil Media and Vegetation
- 4.8 Providing Pedestrian Access
- 4.9 Ensuring Pedestrian Safety
- 4.10 Enhancing Street Design
- 4.11 Accounting for Extreme Weather
- 4.12 Avoiding Design Flaws

This chapter covers design considerations for green infrastructure practices, including a planning checklist and how to select the most appropriate practice based on the pollutant of concern. Designs need to accommodate underground utilities, address stormwater runoff rate and volume, plan for eventual maintenance, and identify appropriate soil media and plants. Green infrastructure designs can include artistic elements to enhance aesthetics and better blend into the community, while also providing for pedestrian access and safety.

Note: The design details described in this handbook are meant to be conceptual and not final design specifications. Designers should refer to state or local requirements and recommendations to inform their designs.



Green street with streetcar, vehicle, pedestrian zones, rain gardens and trees.



Trench drain conveys street runoff into bioretention cells in Washington, DC.

4.1 Design Checklist

Designing Green Infrastructure

Design of the green infrastructure practice(s) should not proceed until after a field visit has confirmed that a site is suitable. This chapter provides information on design elements that should be considered when developing detailed design plans to achieve one or more objectives that pertain to the use of green infrastructure.

The design checklist shown in Table 4-1 summarizes key questions that designers should answer when developing the site design plan for a green infrastructure practice in a street or parking lot. As noted in the table, further discussion about each question is provided elsewhere in this document.

Designers should also consider applying the following practices when initiating a project:

- Conduct a geotechnical study for the site itself. Do not substitute a report from a nearby project.
- Be mindful of all uses on the site (e.g., carts in a shopping mall, informal pedestrian pathways) to protect soils and vegetation from encroachment.
- Design a stormwater control practice that you would want in front of your own house or business. The aesthetic appeal of the practice is important.
- Engage community participants early and throughout design process.

Table 4-1. Site design green infrastructure planning checklist (after site selection is complete)

Yes/No	Checklist for green infrastructure design
	Does your design include green infrastructure practices best suited to remove pollutants of concern? (See section 4.2)
	Has the design taken into account the presence of underground utilities on the site? (See section 4.3)
	Does the curb cut design (i.e., size and angle of opening, placement, grading) effectively capture the stormwater? (See section 4.4)
	If needed, is there an appropriate pretreatment device to capture sediment? (See section 4.5)
	Is there sufficient space available to treat and/or retain the runoff volume from the contributing drainage area? (See sections 4.4 and 4.11)
	Is there a structural feature at the inlet and along the flow path to dissipate energy, slow the velocity and prevent erosion? (See section 4.5)
	Is there ample volume for retention, correct placement and grade of outflow structures to control ponding and adequate structures to manage overflow? (See section 4.5)
	Is there access for maintenance equipment and space for cleanouts and observation wells? (See section 4.6)
	Does vegetation have sufficient soil volume of the appropriate composition type to thrive? (See section 4.7)
	Has the selection of vegetation accounted for local availability, water requirements, ponding and salt tolerance, maturity rate, sightlines, propensity for seed dispersal and maintenance needs? (See section 4.7)
	Does the layout of the green infrastructure practice allow movement through the site, especially by pedestrians (i.e., pathways to allow access between sidewalks and parking lanes across stormwater feature)? (See section 4.8)
	Are there visual or physical barriers around the green infrastructure practice to serve as a safety marker and protect the vegetation? (See section 4.9)
	Does the design support your community’s livability objectives? (See section 4.10)

4.2 Selecting Appropriate Practices

The types of green infrastructure practices selected for your design will depend somewhat on the types of pollutants of concern in your stormwater and your water quality objectives. Table 4-2 provides an overview of the potential pollutant removal capability of common green infrastructure practices, which will help designers choose the practices best suited for their community's needs.

Various factors will influence the performance of green infrastructure practices, including site characteristics, design specifications, and operation and maintenance practices. The use of sequential practices (e.g., a treatment train approach) in a system also will affect overall performance. Refer to the additional resources listed (see box, next page) to understand how site and design factors influence performance.



Dan Christian, Tetra Tech, Inc.

Stormwater curb extensions, such as this one in Portland, OR, capture pollutants such as total suspended solids, total phosphorus, zinc and lead.

Table 4-2. Relative effectiveness of green infrastructure practices for various constituents based on pollutant-removal efficiencies when practices are properly maintained

	Total Suspended Solids	Total Nitrogen	Total Phosphorus	Fecal Coliform	Total Zinc	Total Copper	Total Lead
Bioretention	●	○	●	–	●	–	●
Bioswale	●	○	○	○	–	–	–
Stormwater curb extension	●	○	●	–	●		●
Stormwater planter	●	○	●	–	●	–	●
Street trees	●	●	●	●	○	●	●
Infiltration trench	●	○	●	●	●	–	–
Subsurface infiltration and detention	●	●	●	●	●	●	●
Permeable pavement	●	–	●	–	●	●	●
Permeable Friction Course	●	–	–	–	●	●	●

Note: The values for subsurface infiltration and detention were considered equivalent to those for sand filters. Stormwater curb extension and stormwater planters were considered bioretention devices.

For all constituents, ○ = 0-30%, ● = 31-65%, ● = >65%, – = no data

For More Information—Green Infrastructure Practice Performance

Significant research data is available about the performance of green infrastructure for road and parking lot runoff. Monitoring guidance and information on the pollutant removal effectiveness of green infrastructure and conventional best management practices (BMPs) can be found in the [International BMP Database](#), which is managed by the Water Environment Research Foundation WERF). It is important to note that performance and cost-effectiveness of practices depend on site conditions and design considerations.

The Transportation Research Board, through its National Cooperative Highway Research Program, provides funding to review the water quality benefits and construction and maintenance needs of stormwater BMPs used on roads. Their reports include:

- [Volume Reduction of Highway Runoff in Urban Areas: Guidance Manual](#) (2015)
- [Long-Term Performance and Life-Cycle Costs of Stormwater Best Management Practices](#) (2014)
- [Measuring and Removing Dissolved Metals from Stormwater in Highly Urbanized Areas](#) (2014)
- [Pollutant Load Reductions for Total Maximum Daily Loads for Highways](#) (2013)
- [Guidelines for Evaluating and Selecting Modifications to Existing Roadway Drainage Infrastructure to Improve Water Quality in Ultra-Urban Areas](#) (2012)
- [Evaluation of Best Management Practices for Highway Runoff Control](#) (2006)

The Federal Highway Administration (FHWA) has developed several resources to assist communities in modeling, monitoring and managing water quality impairments from highway stormwater runoff, including:

- [Stochastic Empirical Loading Dilution Model \(SELDLDM\)](#) (2013) A joint project between U.S. Geological Survey and FHWA, this model helps develop planning-level estimates of event mean concentrations, flows, and loads from a highway site and an upstream or lake basin.
- [Determining the State of the Practice in Data Collection and Performance Measurement of Stormwater Best Management Practices](#) (2014) This report assesses data collection and performance measurement in stormwater programs at state departments of transportation.
- [National Highway Runoff Water-Quality Data and Methodology Synthesis](#) (2003)
 - Volume 1: Technical issues for monitoring highway runoff and urban stormwater, FHWA-EP-03-054
 - Volume 2: Project Documentation, FHWA-EP-03-055
 - Volume 3: Availability and documentation of published information for synthesis of regional or national highway runoff quality data, FHWA-EP-03-056
- [Remotely Monitoring Water Quality Near Highways – A Sustainable Solution](#) (2015) This document explores selecting and using a renewable and self-sustaining onsite monitoring system for highway runoff.



Alisha Goldstein

Trees planted in a bioswale between parking stalls.



Alisha Goldstein

Permeable concrete installed in a Washington, DC, alley.

4.3 Accommodating Utilities

Although underground utilities are often cited as a challenge to green infrastructure implementation, their presence on a site does not need to prevent green project development. Depending on the site, planners have the option to avoid, coexist with, modify, or replace utilities when installing green elements (Figure 4-1). Obstacles arising during project design can include requirements for:

- Allowing access to utility lines or pipe galleries for repair or replacement.
- Providing adequate protection around utility lines and gravel envelopes.
- Eliminating potential for infiltrated stormwater to migrate into conduits and pipes.
- Leaving space available to accommodate vaults and valve boxes.

Depending on the site, these obstacles could be too costly or difficult to overcome. In other cases, workarounds are available to handle these utility challenges and enable construction of green infrastructure within the right-of-way. Key steps to eliminate problems include:

- Placing all utility vaults outside the “wet” zone of the stormwater feature when possible.
- Lining the practice along curbs or next to utility trenches with a thin, impermeable geotextile or liner to prevent migration of infiltrated stormwater.
- Constructing a deeper-than-conventional curb profile to physically separate roadbed subgrade or utility lines from the stormwater feature.
- Installing a clay or other impermeable plug within the utility trench to inhibit movement of stormwater within the trench line.

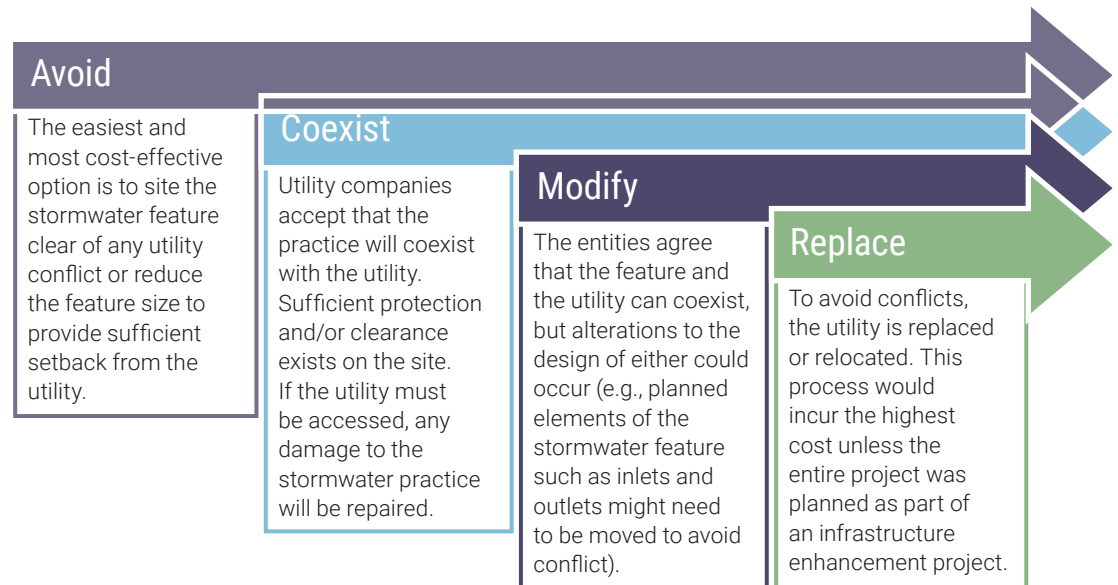

Source: Adapted from the [San Mateo Green Infrastructure Design Guide](#) (San Mateo 2020).

Figure 4-1. Options for accommodating utilities during design and planning of green infrastructure.

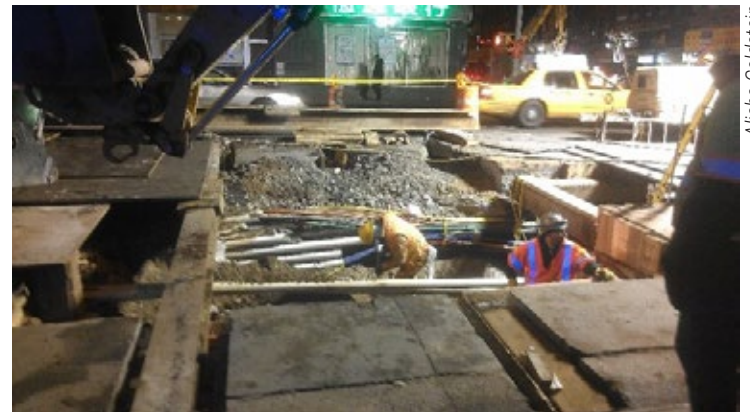

Underground utilities in New York City, NY.

4.4 Capturing Stormwater Runoff Types

An essential element of green infrastructure project design is ensuring the stormwater enters the system and is captured. In urban environments where curbs are prevalent, stormwater flow accumulates as it moves along the curbed edges of roadways. Adding curb cuts allows this concentrated flow to spill into green infrastructure practices. In contrast, stormwater drains off curbless roadways under sheetflow conditions to the lowest area.

For both concentrated flow entering a practice through curb cuts and sheet flow conditions, a minimum 2-inch elevation drop is recommended between the surface drainage and finish grade at the entrance to the stormwater feature to ensure that stormwater freely moves into the practice even with some sediment accumulation. To prevent erosion, an inlet should be designed with a dry sump, splash pad or other element that dissipates energy and spreads the flow. Riprap, stone and gravel are typically used, but some communities are moving away from these materials because they are difficult to maintain cost-effectively.

Capturing Concentrated Flow: Curb Cuts

To capture stormwater runoff from curbed roads, curb cuts are added at intervals along a raised curb, resulting in areas of concentrated flow. This practice is commonly used in urban bioretention cells, stormwater curb extensions, stormwater planters and urban tree trenches. Three key criteria should be considered when designing curb cuts:

- **Placement.** The curb cut should be placed in the pathway of stormwater flow alongside the gutter line. During the low levels of flow, water is directed into the feature; during high flow volumes when the feature is at capacity, the flow bypasses the curb cut and is directed downgradient along the curb.
- **Grading.** Slope the bottom of the concrete curb cut toward the practice (Figure 4-2). If the flow lines along the gutter are on a steep slope, developers can add a small, low-profile asphalt/concrete berm or other pavement

modifications such as a runnel to direct stormwater flow into the practice (Figure 4-3).

- **Size and angle of opening.** The inlet opening can be sized for the storm event using standard FHWA software ([Hydraulic Toolbox](#)) or other design procedures that account for ponding, spreading of flow, slope and other conditions that affect the efficiency of the inlet. The curb cut opening should be as wide as possible to avoid restricting flow or becoming blocked by debris (Figure 4-4). The recommended minimum width is 18 inches or 3 feet in between wheelstops in a parking lot (Figure 4-5). The sides of the opening should have either vertical or chamfered (i.e., cut) sides with 45-degree angles (Figure 4-6). Side wings work well for practices that have steeper side slope conditions to retain the side-slope grade (See Figure 4-7).

Curb cuts can be modified based on site-specific conditions. Grated curb cuts prevent trash and other floatables from entering the practice (Figure 4-8). A trench drain (a shallow concrete trench with a grate or solid cover) can convey runoff to the practice where pedestrians or vehicles must cross the drain area (Figure 4-9). These drain systems help to provide egress space for on-street parking and to maintain grade and access for pedestrians.



Figure 4-2. An angled curb cut with a graded gutter, Seattle, WA.



Figure 4-3. A runnel directs stormwater flow, San Juan Island, WA.



Low Impact Development Center

Figure 4-4. Metal extension inlet structure provides a wide opening for stormwater flow to enter the stormwater feature.



Alisha Goldstein

Figure 4-5. The space between adjacent wheel stops allows stormwater runoff to enter a vegetated swale in a parking lot in Cleveland, OH.



Alisha Goldstein

Figure 4-6. A curb cut with 45-degree chamfered edges conveys stormwater into a roadside rain garden in Friday Harbor, San Juan Island, WA.



Nancy Arazan, USEPA

Figure 4-7. A curb cut with wings retains the side slope grade and directs street runoff into a bioretention feature in Portland, OR.



Rebecca Dohm

Figure 4-8. A grated inlet prevents large floatable trash from entering practice along Deaderick Street in Nashville, TN.

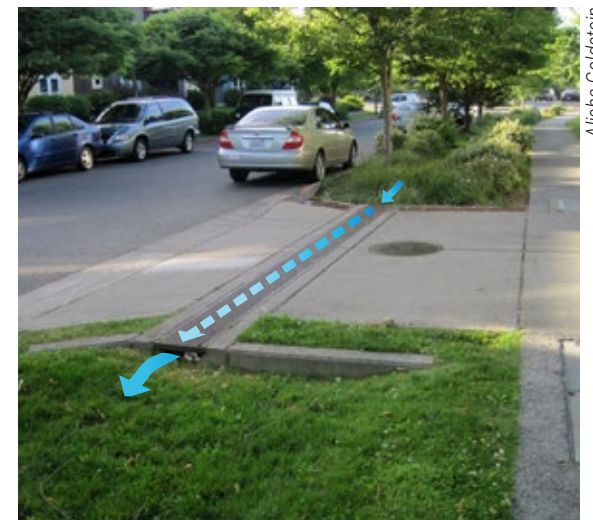

Alisha Goldstein

Figure 4-9. Trench-grated drain conveys stormwater between swales while also capturing runoff in Seattle, WA.

Capturing Sheetflow

In areas without curbs and gutters, practices are designed to capture runoff via sheetflow across pavement and other surfaces. Establishing sheet flow conditions allows for an even distribution of runoff into the feature (Figures 4-10 and 4-11). Moreover, in conditions of low-velocity sheetflow, pretreatment such as a pea gravel apron installed between the impervious area and the practice can help capture suspended sediment.

Green infrastructure practices that capture sheet flow from curbless streets and parking lots often include a band of concrete edging that lies flush with the stormwater feature and the street/parking lot surface (Figure 4-12). Because of concrete's fine-grain composition, it is easier to use concrete than asphalt to achieve the necessary flat slope that will direct sheetflow into the stormwater feature.

Sidewalks can be designed with slight inslopes or outslopes to direct sheetflow into green infrastructure practices, but the sidewalks must also comply with local codes and ordinances and meet the slope requirements outlined in the Americans with Disabilities Act.



Alisha Goldstein

Figure 4-10. A curbless street allows sheetflow stormwater runoff to enter the vegetated swale in Lansing, MI.



Kary Phillips Tetra Tech, Inc.

Figure 4-11. A curbless grassed and gravel parking lot allows sheetflow stormwater runoff to enter a vegetated swale in Staunton, VA.



Nancy Arazan, USEPA

Figure 4-12. A sloped concrete band along a road evenly distributes stormwater to an adjacent vegetative swale in Seattle, WA.

4.5 Managing Stormwater Flow

After a site-appropriate practice is selected to capture the stormwater flow, several techniques should be considered to manage the flow as it enters and exits the practice. Correct design elements can prevent erosion, enhance treatment capabilities and maintain the stormwater feature's function:

- **Pretreatment** practices can trap sediment or debris suspended in the runoff before it enters the practice.
- **Energy dissipation** elements help prevent scouring and erosion of the media around the inlet.
- **Overflow structures** allow excess flows to exit the system to prevent scouring or other damage.
- **Bypass structures** permit excess flow to bypass the practice completely.
- **Back-up infiltration** practices catch flows that exceed the design capacity of the practice.
- **Underdrains** remove excess volume to protect the system and also to reduce ponding or improve infiltration in low-permeability areas.

Pretreatment Practices

Pretreatment is often recommended to trap sediment or debris before it moves through the stormwater management practice because the sediment could clog the practice, reducing infiltration. Commonly used sediment pretreatment devices include forebays, swales/channels, catch basin sumps, grit chambers and filter strips (Figure 4-13). For details about specific pretreatment practices, refer to Chapter 5.

Depending on the volume of flow and available space, pretreatment measures are often designed at the entrance to the practice using a forebay with an overflow structure such as a weir (Figure 4-14). Pretreatment measures should be sized according to the expectant loads and type of debris (e.g., floatables, leaves, sediment). The area downstream of the forebay commonly has high-density planting of vegetation that acts as a containment dam. To ensure the functionality of any pretreatment measure, accumulated sediment should be periodically removed.



Alisha Goldstein

Figure 4-13. A sediment forebay slows the concentrated flow to allow sediment to drop out of suspension in Tucson, AZ.



Jason Wright, Tetra Tech, Inc.

Figure 4-14. A sediment forebay with weir helps trap sediment and control flow volume in an alleyway bioswale in Los Angeles, CA.

Energy Dissipation

Adding energy-dissipating elements at both the inlet and along the length of the green infrastructure practice will help manage fast-moving stormwater flows. A concrete splash pad (Figure 4-15), riprap or landscape stone should be installed just inside the inlet to dissipate the flow as it enters, which will help prevent scouring and erosion of the soil media around the inlet.

Throughout a linear practice, especially those with a steep grade, check dams and weirs should be built at intervals to reduce the velocity, thereby avoiding wash-out and increasing storage (Figures 4-16, 4-17 and 4-18). Check dams are stone, concrete, wood or soil berms that are perpendicular to the flow and span the width of the treatment cell. Check dams help pond water, which increases infiltration by slowing water flow velocity in high slope conditions (BES 2008) and reducing erosion. Scour protection, which can be provided by placing a strip of gravel at the downstream side of the check dam, can also control erosion. Check dam height should be less than the top elevation of the curb. The placement of check dams is dictated by flow rates and velocities.

Weirs can be designed with adjustable heights to provide flexibility on sites that have variable soil conditions. These practices also help control the ponding of water, which influences the hydraulic residence time and effective treatment. A longer retention time helps to settle sediment out of suspension and filter pollutants. As a result, check dams are also applied on sites with minimal longitudinal slopes to promote infiltration where the soils are suitable, or to promote filtering to an underdrain in areas with poorly draining soils.



Eric Vance, USEPA

Figure 4-15. Concrete paver splashpad dissipates energy from stormwater entering from a trench in Washington, DC.



Alisha Goldstein

Figure 4-16. A piled stone weir/gravel filter combination slows the water flowing through this bioretention feature in Gainesville, FL.



Abby Hall, USEPA

Figure 4-17. Concrete check dams slow flow in a stormwater curb extension with a 4.2% slope in Portland, OR.



Alisha Goldstein

Figure 4-18. Concrete check dams with splashpads slow flow velocities along a steep slope in Seattle, WA.

Overflow Structures

Overflow structures are designed to discharge excess stormwater flow from the feature to prevent flooding or damage to it. Practices can be designed as off-line or on-line practices. An off-line practice is sited outside of the normal runoff flowpath and is designed to receive and treat a specified water quality volume. Off-line practices must infiltrate the required design storm amount and will have an emergency overflow path or a bypass/flow-splitter device (see next page) to convey excess flows to an alternative practice or storm drain system. On-line systems are placed within the normal runoff flow path and always require an outlet to allow excess flow to move through or around the practice.

A system should be designed to dewater within 24 to 72 hours after saturation (refer to your local jurisdiction for specific time requirements for dewatering). This design feature will help prevent long-term saturation and ensure the system has storage available for the next storm event. Dewatering also reduces the likelihood that mosquito breeding can occur within the practice.

Key design considerations for overflow systems include:

- The **overflow inlet** should be sized to pass flows that exceed the design storm event. The inlet structure should be wide enough to allow access for cleaning the outflow pipe or the underdrain. The top of the inlet should be set at the ponding depth, approximately 6 to 12 inches (depending on local regulations and site conditions) above the top of the mulch layer (Figures 4-19, 4-20 and 4-21). Using a domed grate on the top will prevent debris from entering the overflow structure and will be less likely to become clogged than a flat grate (Figure 4-22).
- An **overflow weir** should be included in on-line facilities. The weir should safely convey overflow from a larger-scale storm event to an adequate outfall. For small-sized practices receiving low flows, a stabilized reinforced grass outfall might be sufficient.
- The **overflow outlet** should drain to a stabilized outfall and be connected to a manhole, inlet or other structure. Carefully consider maintenance requirements because of the potential for clogging of the inlets and the consequence of the underdrain becoming blocked. Calculate hydraulic grade lines to ensure the outfall pipes are adequately sized.



Nancy Arazan, USEPA

Figure 4-19. Raised overflow structure in a bioretention feature in Houston, TX.



Rebecca Dohn

Figure 4-20. Concrete band structure constructed around the outflow allows ponding in Nashville, TN.



Alisha Goldstein

Figure 4-21. Raised overflow drain allows a design volume of stormwater to collect in a bioretention area in Portland, OR.



Alisha Goldstein

Figure 4-22. Beehive overflow grate prevents debris from entering the overflow structure in a roadside bioswale in Arlington, VA.

Bypass Devices

Bypass devices such as diverters and splitters can be used to prevent high water flows from causing damage to a stormwater feature. Bypass devices are typically incorporated into off-line green infrastructure practices (i.e., outside of the normal runoff flow path). Off-line practices are designed to receive and treat a specified water quality volume (e.g., the runoff generated from a 1-inch, 24-hour storm). In the case of roadside practices, the size of the opening and depth of the feature controls the amount of runoff allowed to enter the practice (e.g., planter, bioretention cell)—allowing flow to be bypassed in two ways:

1. A practice is designed with an entrance that restricts the amount of water able to enter the practice (e.g., curb cuts, weirs); therefore, high-volume flows are split so only a controlled amount of runoff enters the practice while the rest continues on its normal flow path.
2. A practice is designed to collect a controlled amount of runoff until reaching its water quality treatment design. At that time, the system will redirect all excess stormwater back into the normal runoff flow path, which is often a conventional curb-and-gutter stormwater conveyance system (Figure 4-23).

Back-up Infiltration Practices

Backup infiltration approaches can be used when adjacent surface areas are available to provide additional infiltration capacity. For example, overflows from permeable pavements can be managed by placing a strip of exposed gravel downslope of the pavement that will direct excess runoff to a nearby grassed area, or by incorporating vegetated swales that can collect and infiltrate excess volume (Figure 4-24).



Figure 4-23. In this tree pit bypass system in Washington, DC, curb cuts allow stormwater to enter until the practice is filled, at which point additional flow bypasses the system and continues down the street to the storm drain.



Figure 4-24. Vegetated swales were installed adjacent to a permeable parking lot in Chicago, IL, to provide overflow control and back-up infiltration as needed.

Underdrains

Underdrains can also be used to manage excess volumes of stormwater flow, depending on the suitability of the underlying soil structure, soil condition, depth to seasonal mean high water table and the capacity of the system relative to volume. Overflow systems are generally preferred over underdrains because they are easier to maintain and not as likely to clog. Overflow devices also allow the feature to be used to retain and infiltrate the desired water quality volume. In contrast, systems with underdrains often serve primarily as filtration systems. Underdrains are also used to reduce excessive ponding or improve infiltration in areas of lower permeability (i.e., where native soils have infiltration rates of less than 0.5 inches per hour). If an underdrain is included, it should be designed appropriately to convey flows to existing inlets or manholes.

An underdrain consists of a perforated pipe set in a drainage gravel bed (Figure 4-25). The underdrain pipe is typically a 4- to 6-inch polyvinyl chloride (PVC) or high-density polyethylene (HDPE) perforated pipe with equally spaced holes. The upstream end of the underdrain is fitted with a cleanout to allow the underdrain to be inspected and cleaned if necessary. A cleanout consists of a pipe that is accessible from the surface of the practice. The pipe is connected to the underdrain at a 45-degree angle in the direction of flow via an elbow or wye (y-shaped plumbing fitting). A cleanout typically extends vertically 6 to 12 inches beyond the top of the mulch layer, set flush with the designed ponding depth.

The top end of the cleanout is fitted with a locking cap. The exact size of the underdrain opening should be selected based on the drainage area of runoff entering the practice and the time needed to dewater the system. The system should be dewatered within 24 to 72 hours after saturation (refer to local jurisdiction for specific time requirements for dewatering).

The upstream end of the underdrain is also capped. The downstream end of the underdrain is connected to an overflow inlet or curb cut. The underdrain may be level, but it is recommended to have a minimal slope, such

as 0.5 percent, so that any accumulated debris or sediment can be flushed through the system as it drains.

If water retention is a performance requirement, underdrains can be installed above the bottom extent of the practice or designed with a 90-degree upturned pipe so that the system begins to drain only after the required water volume is retained. The water percolates down through the soil into the internal water storage (IWS) layer and is slowly released into the soil underneath the practice.

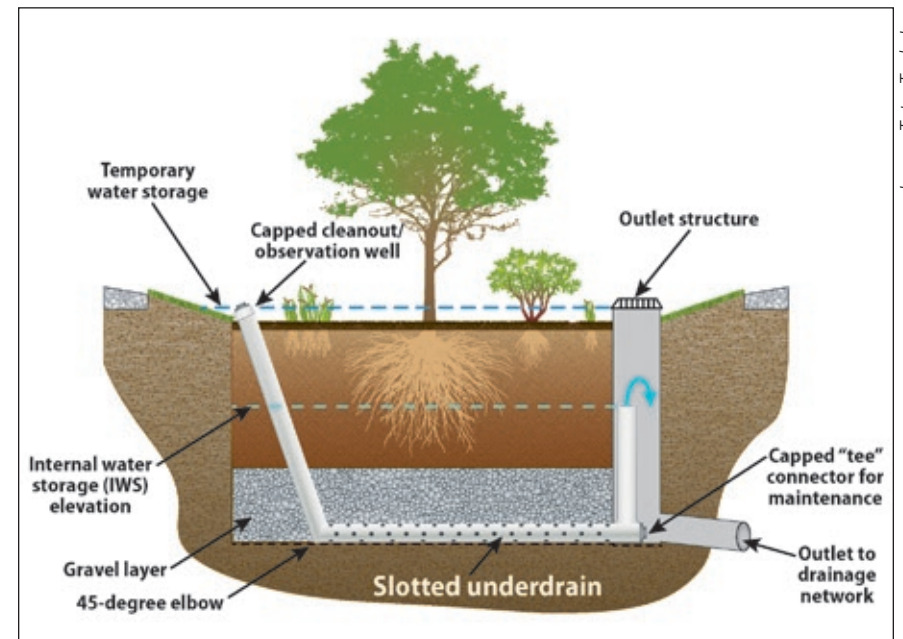

Figure 4-25. In this underdrain design cross-section image, an upturned pipe connected to a slotted underdrain ensures that a permanent internal water storage layer is maintained within the practice before the excess infiltrated water spills into a secondary drainage network. In this design, a surface overflow drain is included to provide added protection against high volume flows.

4.6 Planning for Maintenance

Structural Practices

Maintenance should be considered as part of any green infrastructure design. To perform recommended tasks, the design plan must allow for access into the practice by personnel and maintenance equipment and must provide space for pipe drain cleanouts and possibly observation wells (Figures 4-26 and 4-27).

Certain design practices can influence the type of maintenance needed. For example, the size of openings on a grated trench drain could limit the type of trash that enters the practice, reducing the amount of clean-out needed. In some cases, however, small grate openings can clog easily, needing more frequent maintenance in areas with abundant trash (Figure 4-28).

Site conditions can also influence selection of the practice and requisite maintenance. For example, a curbside neighborhood might not be suitable for permeable pavement without the construction of sediment traps because pavers can easily become clogged.

Specific maintenance for each stormwater management practice is discussed in Chapter 6. At a minimum, practices should be inspected annually to remove trash, clean inlets/outlets, remove invasive species, prune vegetation and replace mulch. Maintenance should be conducted after large storms and more frequently while vegetation becomes established.

Nonstructural Practices

In addition to the specific maintenance practices required for each green infrastructure practice, communities can identify and implement non-structural practices that help prevent pollution from entering the watershed drainage system (see box at right). These practices in turn reduce the maintenance needed on structural practices.

Nonstructural practices require programmatic management to develop implementation plans, select appropriate technology and budget the resources for these ongoing tasks. Quantification of performance for nonstructural practices varies widely because it depends on the frequency and type of application, site-specific characteristics and climate.

Key Nonstructural Practices

- Street sweeping
- Catch basin and storm drain cleaning
- Irrigation runoff reduction practices
- Slope and channel stabilization
- Trash management
- Anti-icing management
- Water-smart landscaping
- Erosion control on construction sites
- Spill prevention and response plans
- Education/awareness for the public and employees



Figure 4-26. A wide-angled curb cut with an energy-dissipating splashpad also serves as access steps for maintenance in Maplewood, MN.



Figure 4-27. To facilitate maintenance, an observation well is installed next to a bioretention area in Houston, TX.



Figure 4-28. The small spaces in this grate are clogged with cigarette butts, which block drainage and are difficult to remove.

Alisha Goldstein

4.7 Selecting Soil Media and Vegetation

Soil Media Selection

The specifications for filter media mixes will vary by availability of local materials, local climatic conditions and stormwater requirements for the specific placement of the green infrastructure practice within the transportation corridor. A typical filter media mix will include a well-blended, homogenous combination of the following soil types:

- **Sand.** Must be cleaned and washed to be free of deleterious materials. A medium "concrete" sand such as ASTM C33 or an equivalent is often used (average particle diameter <2.0 millimeters is recommended).
- **Silt and clay.** Includes fines with a texture of sandy loam, loamy sand or loam mixture to encourage nitrogen, phosphorus, metal and other pollutant removal. (Note: a low-clay content, less than 2 percent, is necessary to avoid clogging.)
- **Organic matter.** Commonly includes a compost or mulch amendment.

To support plant growth while removing phosphorus from runoff, the filter media mix must have a low phosphorus index (P Index). The P Index is a management tool that estimates the relative risk of phosphorus leaching. Recommended levels are between 10 and 30 milligrams per kilogram when using the Mehlich-3 test (MPCA 2013). Organic matter can be a source of phosphorus loading and must be carefully managed where elevated phosphorus concentration is a concern.

Geotextile fabrics are often used in green infrastructure infiltration practices to protect the filter media from becoming clogged by the sediments and clays contained within in-situ soils. The liners typically extend along the side slopes. The liner should have sufficient openings that are properly sized for the existing soil conditions to prevent clogging. Impermeable liners can be used to prevent infiltration into sensitive sites. The material should be durable and flexible. Composite systems of nonwoven geotextiles are used to prevent puncture during construction.



In preparation for planting local native vegetation, a soil media mix was chosen and backfilled into this roadside bioretention area in San Diego, CA.

Tetra Tech, Inc.

Vegetation Selection

Planting schemes will vary depending on the site location and design specifications; however, soil type and moisture conditions will usually determine the types of species selected. For example, facultative wetland plants are typically used on the bottom of a bioretention cell, while facultative upland species are frequently chosen for areas around the perimeter of a bioretention cell or in mounded areas. Numerous factors should be considered when selecting plants:

- **Soil moisture conditions.** Choose plants that can tolerate summer drought, ponding fluctuations and saturated soil conditions for the design drawdown period.
- **Sunlight.** Assess existing and anticipated exposure (e.g., when vegetation is mature).
- **Expected pollutant loadings.** Select plants that tolerate pollutants from contributing land uses (e.g., choose salt-tolerant plants in cold climates where road salt use is common).
- **Adjacent plant communities and habitats.** Select native plants and hardy cultivars; this is particularly important in areas with significant invasive species.
- **Location aesthetics.** Consider the type of neighborhood, adjacent land uses, and expected pedestrian and roadway traffic (providing pathways and maintaining sight distances).
- **Maintenance needs.** Assess a plant's growth rate and its propensity for seed dispersal.

Native plants are usually adapted to the local climate and provide habitat for wildlife. Selected vegetation should grow tall enough to exceed the desired design flow depth. Additionally, the vegetation should be moderately stiff and non-clumping to provide sufficient surface contact for water quality treatment and to avoid formation of concentrated flow conditions. A mix of fibrous and deeply rooted small trees, shrubs, and perennials will help maintain soil permeability.

Anticipate plants' mature conditions to avoid choosing a species that could interfere with overhead electric lines or with roadway sightlines and or that would require intensive maintenance because it has a propensity to grow and disperse seeds. Properly selecting plants and supporting them during establishment should eliminate the need for fertilizers and pesticides. Initially after planting, frequent maintenance will be necessary to ensure the vegetation becomes established.

Sufficient soil volumes should be made available to the plant (especially trees) to ensure proper growth. If the site doesn't provide ample space, construct root paths to an adjacent open space or structural cells that can support sidewalks or pavement while providing space for unimpacted soil below the ground surface.



Eric Vance, USEPA

Native plants are adapted to local climate conditions and provide valuable wildlife habitat.



Alisha Goldstein

Street trees provide water storage, interception and evapotranspiration.

Urban Street Trees

Including urban trees in green infrastructure designs could pose challenges that must be considered. These include space requirements for the tree pit, soil quality and texture, overhead and underground utilities, pavement, and proximity to structures. A detailed site evaluation can identify these challenges and options to mitigate any problems. EPA's [Stormwater Trees: Technical Memorandum](#) (2016) includes information on site evaluation and site constraints, choosing the right tree, inspection and maintenance.

4.8 Providing Pedestrian Access

Adding Walkways and Bridges Across or Around Practices

When incorporating green infrastructure into a street or parking lot design, pedestrian movement should be carefully considered. Providing clear paths for pedestrians is crucial to the design and is a good practice for protecting green elements from damage.

For on-street parking, adequate space should be provided to allow people to exit their cars and access the sidewalk. A minimum 3-foot-wide egress zone adjacent to the street curb is suggested.

Walkways (Figures 4-29 and 4-30) or bridges (Figure 4-31) can be provided for people to safely cross the green infrastructure practice and access the sidewalk. The use of bridges preserves space, provides continuity of stormwater flow and prevents soil compaction, erosion and trampling of vegetation.

For areas with pedestrian traffic and little room for stormwater planters or tree boxes, porous surface materials (Figure 4-32) are an option to consider. Using these materials allows water to infiltrate and preserves sidewalk width for pedestrian use.



Alisha Goldstein

Figure 4-29. Permeable pavement walkways provide access to on-street parking in Seattle, WA.



Nancy Arazan, USEPA

Figure 4-30. Walkway built across vegetated swale to allow users to access their cars in Portland, OR.

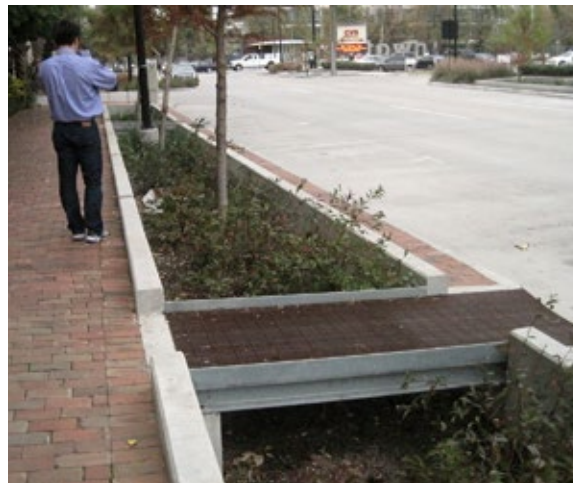

Alisha Goldstein

Figure 4-31. A grated walkway bridge allows pedestrians to access parked cars on Bagby Street in Houston, TX.



USEPA

Figure 4-32. Tumbled green glass fills the spaces between permeable pavers in a sidewalk area in Chicago, IL.

4.9 Ensuring Pedestrian Safety

Providing Visual and Physical Barriers Around Practices

An important aspect with regard to pedestrian safety is assuring that people can detect and are guarded against a sudden drop in grade. Check your city's guidance to determine (1) the maximum allowable depth for a stormwater management practice that is installed adjacent to a pedestrian area and (2) the appropriate or required barrier needed to enclose the practice. A suggested guideline is to install a barrier when the vertical drop is at minimum 6 inches immediately adjacent to a sidewalk. Common techniques to either visually or physically denote a vertical drop include a raised curb edge (Figure 4-33), railing (Figure 4-34), fence (Figure 4-35), detectable warning/paving strips, bollards and/or seating (Figure 4-36).

These design features help ensure that streets or parking lots are safe and accessible for all users. Many green infrastructure practices can be used to enhance the pedestrian experience and provide a buffer against vehicular traffic, reduce pedestrian crossing distances and/or improve sight angles at intersections.



Alisha Goldstein

Figure 4-33. A raised curb with inlets defines the edges of a sidewalk stormwater planter in Washington, DC.



Alisha Goldstein

Figure 4-34. Fence protects pedestrians from the drop in grade in the adjacent bioretention feature in Minneapolis, MN.



USEPA

Figure 4-35. Short fencing protects pedestrians from stepping into this stormwater tree box in Washington, DC.



Melissa Kramer, USEPA

Figure 4-36. Seating adjacent to a bioretention unit provides an amenity for passersby and also serves as a barrier in Washington, DC.

4.10 Enhancing Street Design

Adding Artistic Elements

Green street design can incorporate artistic features such as sculptures, murals and concrete imprints. In many cases, the stormwater management practice itself is designed as an artistic feature. These elements can enhance community aesthetics and attract visitors.



Alisha Goldstein

The Beckoning Cistern serves as an artistic feature and a stormwater management practice. Designed to resemble a large upturned hand, the 15-foot-tall structure adds visual interest while collecting roof runoff, some of which is directed into a series of cascading stormwater planters along Vine Street in Seattle, WA.



Alisha Goldstein

Concrete art can highlight the presence of green infrastructure. The raindrop ripple effect sidewalk etching allowed the Watershed District's Public Art Initiative to call attention to the function and benefit of rain gardens in managing stormwater in the Bartelmy-Meyer neighborhood in Maplewood, MN.



USEPA

A bioretention area artfully designed to resemble a rocky river wraps around the Oregon Convention Center in Portland, OR.



Alisha Goldstein

Artists collaborated on this curving bioretention design for the Waterloo Parking Lot in a Cleveland, OH, art district.

Adding Community Amenities

Incorporating user amenities such as benches, bicycle racks and street-lights into green streets planning and design helps encourage use of the area by pedestrians and cyclists. By creating an attractive and welcoming streetscape, community livability improves, which potentially benefits neighborhoods and businesses.



Alisha Goldstein

Decorative stone benches installed at the edge of a bioretention area offers a resting spot for pedestrians along Sandy Boulevard in Portland, OR.



Alisha Goldstein

Incorporating bicycle lanes and bicycle racks into green street design encourages non-motor vehicle access along city streets in Austin, TX.



USEPA

Benches installed next to stormwater curb bumpouts provide an area to rest in the New Columbia neighborhood in Portland, OR.

4.11 Accounting for Extreme Weather

Arid Climates

Designing practices for arid regions requires different considerations. The low amount of annual precipitation in these areas reduces the storage area needed to treat water quality. Because of high evaporation rates, any harvested rainwater should be stored in a closed container instead of stored with a large surface area exposed to the sun. The low frequency of storm events can lead to a build-up of pollutant concentrations. Therefore, the capture volume designated for first-flush treatment should be greater than those designated for humid regions.

The soil and topography in arid regions are conducive to soil erosion and increased sediment transport due to flashy storm events and wind action. Particular care should be given to the selection of vegetation according to these principles:

- The type of plant species and the number of plantings should be chosen with respect to the available water supply. Native and drought-tolerant plants are suggested.
- If irrigation is deemed necessary, group plants according to their water needs and adjust irrigation schedules according to the season and weather.
- Plants should be able to tolerate inundation.

A resource for determining water needs for specific plants is presented in Brad Lancaster's [Rainwater Harvesting for Drylands and Beyond, Volume 1](#) and the Arizona Municipal Water Users Association's [Landscape Plants for the Arizona Desert](#).

Note: Before harvesting rainwater or designing and installing any green infrastructure, check the regulations pertaining to water rights in your locale.

Cold Climates

For a cold-climate environment, the predominant design consideration are snow and deicing agents. Areas adjacent to roadways or parking surfaces are commonly used to stockpile snow that has been plowed from surfaces. These areas accumulate large water volumes and high pollutant loadings (e.g., sand and gravel, deicing chemicals, hydrocarbons). Infiltration practices should not be placed in areas that are dedicated as snow storage areas. Deicing agents and debris from the roadway will negatively impact vegetative growth and can clog media and permeable surfaces.

Two suggested management strategies can help overcome the challenge of co-managing snow and stormwater:

- If possible, collect snow on an impervious pad and divert the meltwater for treatment (e.g., detention and routing to a wastewater treatment facility).
- Minimize the pollutants associated with meltwater runoff by using improved application technology with trucks and reducing the use of deicing chemicals.
- Design pretreatment facilities to remove particulate material before any snowmelt enters a stormwater infiltration practice.

Research has shown that green infrastructure, such as permeable pavement, groundwater recharge by local infiltration, and road drainage infiltration systems, can be effective under cold-climate conditions as long as they are adequately maintained to assure their effective performance (MCPA 2013).

4.12 Avoiding Design Flaws

Improper design and a failure to consider the surrounding site characteristics can lead to diminished function of green infrastructure. The following images present and explain some design problems that prevent a practice from functioning at full capacity or cause other problems.



Alisha Goldstein

These permeable pavers received runoff from a gravel driveway and became clogged with sediment.



Alisha Goldstein

The large-spaced grate on this overflow drain will not prevent floatables and debris from entering.



Alisha Goldstein

These unsecured blocks installed next to a bioretention area pose a safety risk.

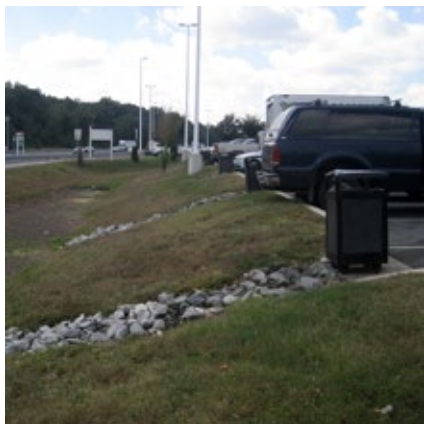

Alisha Goldstein

These trash cans, installed in front of stormwater inlets, block flow.



Alisha Goldstein

This undersized curb cut is easily clogged by mulch and other debris.



Alisha Goldstein

The overflow drain is placed in the flow path of water entering the practice.



Alex Foraste, USEPA

This stormwater planter does not provide space for passenger exit.

5 Pretreatment Practice Options

In This Chapter

- 5.1 Sediment Forebays
- 5.2 Vegetated Filter Strips
- 5.3 Swales
- 5.4 Modified Catch Basins
- 5.5 Flow-Through Structures

This chapter covers information on pretreatment methods that should be considered when designing green infrastructure systems. Pretreatment practices help protect the main treatment systems by dissipating energy and reducing flow velocity, removing coarse sediments and large particles from the flow, capturing trash and other debris, and reducing overall stormwater flow volume by encouraging infiltration. Successful, functioning pretreatment practices will help improve performance, reduce maintenance and increase lifespan of the overall stormwater management system.

Note: The design details described in this handbook are meant to be conceptual and not final design specifications. Designers should refer to state or local requirements and recommendations to inform their designs.



A sediment forebay provides pretreatment for parking lot runoff entering a bioretention cell at Villanova University, PA.

USEPA

5.1 Pretreatment: Sediment Forebays

Description

A sediment forebay is an excavated pit or basin with a berm or weir designed to slow and detain incoming runoff. Sediment forebays are placed before practices such as bioretention systems or bioswales to dissipate energy from runoff and allow for sedimentation to occur. Sediment forebays serve to minimize, but do not eliminate, the amount of sediment being transported into downstream practices.

Site Considerations

Sediment forebays provide pretreatment that enhances the performance and longevity of downstream practices. With proper maintenance, sediment forebays can have a long life cycle. As a surface practice, they should be easily accessible for sediment removal and other maintenance. Sediment forebays provide a greater detention time than proprietary separators. Although sediment forebays allow sedimentation of some particulate matter, they primarily remove only coarse pollutants and no soluble pollutants (MADEP 2008). Frequent maintenance is essential to ensure proper performance.

Design Considerations

Slopes should be designed for safety and erosion control (maximum 3:1 [horizontal run: vertical rise (H:V)] slope). The forebay volume should be 10 percent of the water quality volume at minimum. The depth should be a minimum of 2 feet and a maximum of 6 feet.

Energy dissipation methods, such as splash blocks or riprap, should be included at both the inlet and outlet locations. Exposed earth slopes and bottom of basins should be stabilized using seed mixes that are appropriate for the soils, suitable for expected mowing practices, and drought-tolerant or resilient to inundation periods, depending on the volume of stormwater expected. To facilitate maintenance, the bottom of the pretreatment practice may be "hardened" with concrete to allow for easier collection and removal of sediments. Always design your system to allow access to the pretreatment practice for maintenance.



Horsley Witten

A sediment forebay provides pretreatment for a bioretention cell in Barnstable, MA.

Sediment Forebays

Advantages:

- Relatively inexpensive
- Long-lasting if properly maintained

Most suitable for:

- Bioretention
- Bioswales
- Curb extensions

Maintenance Requirements

Because sediment forebays help reduce the sediment load entering green infrastructure practices, it is imperative to remove accumulated sediment to ensure the system continues to function as designed. The frequency of cleaning required depends on the contributing sediment loading rate and the occurrence of storm events. The contributing sediment loading rate is based on the size and type of drainage area. One suggested practice is to install a staff gage or other measuring device to indicate the level of sediment accumulation and to establish a level at which clean-out is required. Typical maintenance needs required for sediment forebays are outlined in Table 5-1.

Table 5-1. Recommended maintenance activities for sediment forebays

	Activity	Frequency	Additional advice
Soil	Remove sediment	As needed, but annually at minimum	If excessive sedimentation is observed, the site might need to be regraded and reseeded to avoid excessive upland erosion.
	Remove any trash on the surface	Twice per year	
	Inspect for rutting caused by concentrated flow	Annually	Eroded areas should be filled in with soil and the bare areas should be reseeded.
Vegetation	Mow embankments to control growth of woody vegetation	Annually (in spring)	If at least 50% vegetation coverage is not established after 2 years, provide additional plantings.
	Remove and replace vegetation as necessary	As needed	If at least 50% vegetation coverage is not established after 2 years, provide additional plantings.
	Weed invasive and exotic species, preferably using nonchemical methods such as hand pulling and hoeing	Annually	



A sediment forebay provides pretreatment for a rain garden in Maplewood, MN.

Sediment Forebays

Key design features and maintenance needs:

- Periodically remove sediment
- Provide a mechanism to dissipate energy from incoming flow
- Avoid compaction during construction and maintenance or by service vehicles

5.2 Pretreatment: Vegetated Filter Strips

Description

Vegetated filter strips are gradually sloped, densely vegetated areas designed to receive and treat sheet flow. They are designed as flow-through devices to slow down and infiltrate runoff and to remove sediment before it reaches a downstream stormwater management practice. Vegetated filter strips can be distinguished from grassed swales because the filter strips typically have more surface roughness, energy dissipation capacity and denser vegetation, while grassed swales serve more as grassed conveyance systems. Performance is limited by grading, because little to no treatment is achieved if the filter strips are short-circuited by concentrated flow paths (MADEP 2008).

Installing a level spreader might be necessary to ensure runoff becomes sheet flow before it enters the vegetated filter strip.

Filter strips can be amended with compost and subsurface gravel to increase removal of dissolved metals and increase moisture capacity, which can improve infiltration rates and reduce flow velocities. An example of this is the compost-amended vegetated filter strip (CAVFS), currently in use in Washington State (WSDOT 2016). Designs can also be modified to provide significant pollutant reduction by incorporating a media filter drain in areas with minimal slopes.

Site Considerations

Filter strips are best suited to smaller drainage areas, low-velocity roadways or small parking lots because they do not have the capacity to reduce peak discharges or handle large velocities (WSDOT 2011). The maximum impervious contributing length should be 75 feet to 100 feet, and the maximum pervious contributing length can be up to 150 feet (SEMCOG 2008; MPCA 2013). Vegetative filters are not suited for areas with traditional curbs and gutters, for sites with excessive longitudinal slope (greater than 5 percent), side slopes (greater than 25 percent), or in areas with unstable slopes or erosive soils (MPCA 2013).

Vegetated Filter Strips

Advantages:

- Perform better than swales because the non-concentrated flow allows for greater sedimentation and infiltration
- Reduces pollutants associated with sediments such as phosphorus, pesticides and insoluble metallic salts

Most suitable for:

- Bioretention
- Bioswales
- Subsurface infiltration and detention

Design Considerations

- **Slope.** To prevent erosion or channelization from developing, design filter strips with slopes between 2 and 6 percent to ensure sufficient velocities and level surface with no pits, gullies, or ruts.
- **Size.** The flow length should be at least 25 feet for sufficient treatment, but should remain less than 75 feet long for impervious drainage areas and 150 feet for pervious drainage areas to prevent channelization from occurring. It is recommended that the filter strip width be equivalent to the width of the area draining to the strip.
- **Border.** To ensure even flow, it is often necessary to border the perimeter of the parking lot or road with a level spreader. Examples of spreader devices include a strip of pea gravel, slotted sections in the highway shoulder that are perpendicular to the road direction, concrete sills or a strip of porous pavement (Young et al. 1996). Level spreaders help to evenly distribute flows and trap sediments.
- **Vegetation.** Dense, soil-binding deep-rooted grasses that are water tolerant should be used in the construction of vegetated filter (Young, et al. 1996). If the filter will receive runoff from highways that require heavy application of deicing salts, salt-resistant plants should be specified.

Maintenance Requirements

It is important to periodically evaluate the condition of the filter strip during the first two years of construction, particularly after major storm events. Typical maintenance needs required for vegetated filter strips are outlined in Table 5-2. The frequencies provided are minimum suggestions; the activities should occur as needed.

Table 5-2. Recommended maintenance activities for vegetated filter strips

	Activity	Frequency	Additional advice
Soil	Remove sediment to ensure sheet flow into the filter area and to avoid concentrated flow	Annually	If excessive sedimentation is observed, the site might need to be regraded and reseeded to ensure sheet flow can be maintained.
	Remove any trash on the surface	Twice per year	
	Inspect for rutting caused by concentrated flow	Annually	Eroded areas should be filled in with soil and the bare areas should be replanted.
	Turn or till soil, especially if compaction occurs	As needed	If maintenance efforts are unsuccessful, the soil media and underdrain might need to be removed and replaced.
Vegetation	Mow turf or grass	At least annually	If at least 50% vegetation coverage is not established after 2 years, provide additional plantings.
	Remove and replace vegetation as necessary	As needed	If at least 50% vegetation coverage is not established after 2 years, provide additional plantings.
	Weed invasive and exotic species, preferably using nonchemical methods such as hand pulling and hoeing	Annually	



Nancy Arazan

Vegetated filter strip at the edge of a parking lot intercepts and filters stormwater runoff before the water reaches the infiltration bed at the center of the practice.

Vegetated Filter Strips

Key design features and maintenance needs:

- Ensure site is graded accurately to maintain sheet flow along entire flow length
- Use level spreaders to slow incoming flow velocities
- Avoid compaction during construction and maintenance or by service vehicles
- Periodically remove sediment
- Maintain a dense vegetative cover

5.3 Pretreatment: Swales

Description

Pretreatment swales are shallow, vegetated channels that capture runoff and slowly convey it along the swale while infiltrating and filtering coarse sediment. They are similar to bioswales, except that they are designed primarily for conveyance without enhanced infiltration/filtration components; therefore, they provide limited water quality enhancement and reduction of runoff volume and peak discharge. Pollutant removal rates will vary greatly with the species of vegetation chosen for the swale. Types of swales include drainage channels, grass channels and dry swales.

Site Considerations

These practices provide coarse sediment removal and limited infiltration and detention. They also convey stormwater to downstream practices. **They are applicable in parking lots and roadways as a pretreatment practice.** Swales can be used in treatment trains to provide initial treatment for practices such as bioretention, surface and subsurface infiltration practices, and stormwater basins.

Design Considerations

Swales should be designed for capacity and stability so the design depth can convey the maximum specified design flow but the channel will not erode under maximum design flow velocities. To maximize treatment performance, runoff should flow through the entire swale. Therefore, runoff should be directed to an inlet and should not enter as sheet flow along the entire length of the swale (CEI and NHDES 2008). Depending on the longitudinal slope, check dams might be necessary to slow down flow and encourage surface contact.

Channel cross-section design should be trapezoidal or parabolic. A study conducted in Texas and California by the University of Texas Center for Research in Water Resources in Texas determined that the optimum cross-section for swales in highway medians is a V-shape, rather than the trapezoidal shape commonly listed in manuals, because most of the treatment occurs along the slopes (Barrett 2004). The bottom of the swale should not be within the seasonal high water table.

Pretreatment Swales

Advantages:

- Provide stormwater conveyance
- The open-drainage systems provide easy access for maintenance
- Are a less-costly alternative to curb-and-gutter stormwater conveyance systems

Most suitable for:

- Bioretention
- Bioswales
- Subsurface infiltration and detention



Grass swale serves as pretreatment for a bioretention area in the High Point neighborhood in Seattle, WA.

The design should include vegetation types that will maximize treatment. Vegetation species should reflect the site specific soil, topography, flow velocities and maintenance needs. If using trees or shrubs in the vegetated swale design, plants that are resilient to both drought and flooding should be selected. Trees should not be planted in areas that require enhanced structural stability (BES 2006). Swales' effectiveness for stormwater treatment is greater where more surface contact occurs. For this reason, a fine, close-growing, flood-resistant grass should be selected.

Maintenance Requirements

It is important to periodically evaluate the condition of the swales during the first year after construction, particularly following major storm events. Mow vegetation to maintain heights of 4 to 6 inches. After 5 years, scrape the channel bottom to remove sediment buildup and restore the original cross-sectional geometry. Typical maintenance needs required for pretreatment swales are outlined in Table 5-3.



USEPA

A pretreatment bioswale conveys and treats runoff from a parking lot and road in Stafford, VA.

Table 5-3. Recommended maintenance activities for pretreatment swales

	Activity	Frequency	Additional advice
Soil	Remove sediment, especially if 3 inches accumulate in any spot or it covers vegetation	Annually	If excessive sedimentation is observed, the site might need to be regraded and reseeded to ensure sheet flow can be maintained.
	Remove any trash on the surface	Twice per year	
	Inspect for erosion	Annually	Eroded areas should be filled in with soil and the bare areas should be reseeded.
	Turn or till soil, especially if compaction occurs	As needed	If maintenance efforts are unsuccessful, the soil media and underdrain might need to be removed and replaced.
Vegetation	Mow turf or grass	Dependent on grass type	If at least 50% vegetation coverage is not established after 2 years, provide additional plantings.
	Remove and replace vegetation as necessary	As needed	If at least 50% vegetation coverage is not established after 2 years, provide additional plantings.
	Weed invasive and exotic species, preferably using nonchemical methods such as hand pulling and hoeing	Annually	

Pretreatment Swales

Key design features and maintenance needs:

- Ensure accurate grading to maintain sheet flow
- Use level spreaders to slow incoming flow velocities
- Avoid compaction during construction and maintenance or by service vehicles
- Periodically remove sediment
- Maintain a dense vegetative cover

5.4 Pretreatment: Modified Catch Basins

Description

A catch basin is an inlet device designed to capture sediment, debris and associated pollutants. Catch basins can be modified with a deep sump to provide extra storage for the accumulation of sediment (Figure 5-1). They can include a hood or inverted elbow to minimize the amount of floatables, oil and grit that can exit the catch basin and enter the downstream treatment practice (Figure 5-2). Finally, they are considered part of a green infrastructure approach if they are modified as leaching catch basins that have perforated sections to allow water to infiltrate surrounding soil.

Site Considerations

Catch basin modifications such as deep sumps and hoods can be used for water quality improvement, but are not designed to reduce runoff volume or peak discharge. Leaching catch basins should not be used where infiltration is not desired (e.g., because of potential groundwater or soil contamination or presence of high groundwater or bedrock). Modified catch basins provide pretreatment for downstream practices by removing

coarse sediment, debris, floatables, oil and grit. Modified catchbasins might be the only applicable practice for sites with constrained spaces, poor infiltrating soils, or existing subsurface contamination.

Modified Catch Basins

Advantages:

- Minimal space requirement
- Compatible with subsurface storm drain systems
- Is long-lasting if properly maintained
- Design allows easy access for maintenance

Most suitable for:

- Bioretention
- Bioswale
- Curb extension
- Stormwater planter
- Trees trenches
- Infiltration trench
- Subsurface infiltration and detention

Image: University of NH Stormwater Center

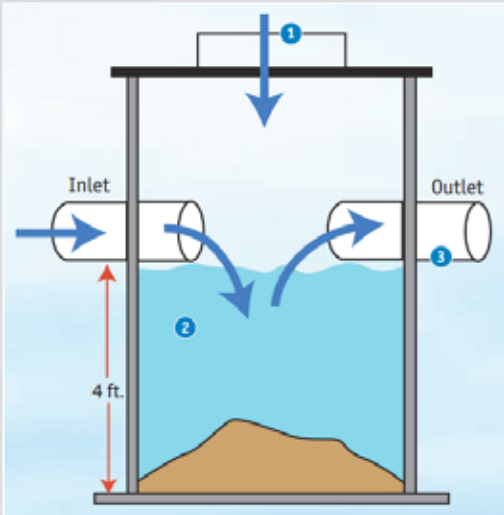

Figure 5-1. Simple modified catch basin

Deep Sump Catch Basin Operation Steps:

- Runoff flows into the deep sump catch basin typically through an inlet or surface grate on the street (1) and drops into the sump (2).
- The sump provides a deep collection area (2) between the incoming flow (1) and outgoing flow (3), which allows coarse sediments and trash to drop out of suspension. Trash grates, hoods (4), or filter skirts can enhance performance by preventing floatables from entering outflow pipes.
- Outgoing flows (3) continue to a centralized drainage network or can be designed to discharge to a surface or subsurface green infrastructure practice.

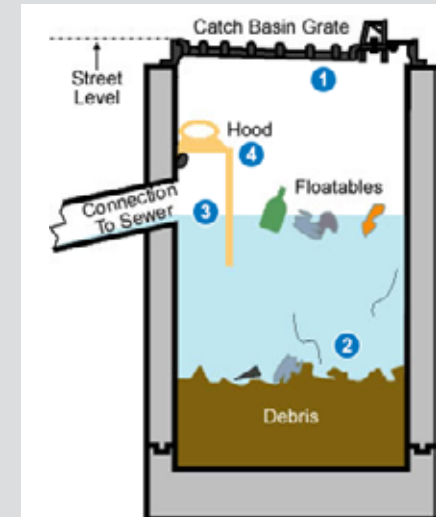

Image: USEPA

Figure 5-2. Hooded catch basin

Modified catch basins are highly applicable in urban and retrofit situations because they are compatible with subsurface storm drain systems and require limited space. Constraints include the presence of underground utilities, shallow bedrock, or a high groundwater table. Catch basins should be easy to access, and they should not be used unless adequate funding for regular inspections and maintenance is ensured.

Design Considerations

Inlets must be sized appropriately to capture the design volume. Inlet sizing is particularly important on steep slopes to ensure that runoff is adequately captured (RIDEM and CRMC 2010). Grates should be sufficient to keep out larger debris, typically with holes of 1 inch or less (MADEP 2008). Recommended maximum drainage area is less than 0.25 acre of impervious areas (NHDES 2008).

Sump depths should be 4 feet or deeper to allow accumulation of sediment and to limit resuspension of accumulated sediment. Except for leaching catch basins that are designed for infiltration, all flow will exit the catch basin through an outflow pipe. These outflow pipes should include a hood or elbow to limit the amounts of floatables, oil and grit that are transported downstream.

To enhance pollutant removal, these systems may be designed off-line to divert large flows to another practice designed for water quantity (MPCA 2013).

Maintenance Requirements

Maintenance is relatively easy and, if properly maintained, these systems can be long-lasting (MADEP 2008). Typical maintenance of catch basins includes trash removal (if a screen or other debris capturing device is used) and removal of sediment using a vacuum truck or wet-vac. As a rule of thumb, once the sump is half full of sediment, it cannot provide additional sedimentation. Depending on location, several cleanings of the sump might be required per year. At minimum, inspection should occur twice annually, once after snow melt and once after leaf drop.

Operators need to be properly trained in catch basin maintenance. Maintenance should include keeping a log of the amount of sediment collected and the date of removal. Some cities have incorporated the use of geographic information systems to track sediment collection and to optimize future catch basin cleaning efforts. The disposal of trapped sediment, debris, oil and grit removed during maintenance activities should be considered during design. Avoid damaging the hood during cleaning activities.

Modified Catch Basins

Key design features and maintenance needs:

- Ensure adequate size for both the inlet and the catchbasin to capture and detain the flow
- Requires access for maintenance
- Inspect and maintain practice at least twice annually (frequency is site-dependent)



Martina Frey, Tetra Tech, Inc.

A curb inlet cover allow runoff to enter a catch basin but prevents inflow of trash.

5.5 Pretreatment: Flow-Through Structures

Description

Flow-through structures are subsurface structures that include a settling or separation unit that improve water quality by removing coarse sediments, floatables, oil and grit from runoff. These types of structures include vortex separator systems, oil and grit separators, and proprietary devices.

The vortex separator systems, also known as swirl separators, hydrodynamic separators and swirl concentrators, use vortex action to separate coarse sediment and floatables from stormwater. Although these practices are not designed to reduce runoff volume or peak discharge, they do provide water quality pretreatment by removing coarse sediment, floatables, oil and grit. Like catch basins, pretreatment flow structures are not considered green infrastructure practices, but they are useful tools that can reduce the negative environmental impacts of transportation infrastructure on water resources. In highly urbanized areas with large percentages of impervious surfaces, these practices can be essential elements of hybrid gray and green infrastructure stormwater management systems.

Site Considerations

These practices are commonly used near the source of runoff and serve as pretreatment to a number of downstream stormwater management practices. These structures can be constructed in locations with potentially high pollutant loads where other practices might not be applicable. Some states and municipalities require oil and grit separators on sites with higher expected pollutant loads or risk of petroleum spills (i.e., high-turnover parking lots, gas stations, fleet storage areas, and vehicle and equipment maintenance areas).

Because they are subsurface systems that require a relatively small footprint, these systems are useful in situations where land availability is limited. The drainage area for such systems is limited by both the capacity of the chosen system and the available land area.

Flow-Through Structures

Advantages:

- Effectively captures coarse sediments and floating debris
- Minimal space requirement
- Can be implemented in any soil or terrain

Most suitable for:

- Bioretention
- Bioswale
- Curb extension
- Stormwater planter
- Trees trenches
- Infiltration trench
- Subsurface infiltration and detention



Horsley Witten

Vortex separator being installed.

For More Information—Pretreatment

[Underground Hydrodynamic Separators](#). Fact sheet. Montgomery County, MD (2018)

[Pretreatment](#). Philadelphia Water Stormwater Management Guidance Manual (Chapter 4, Section 10). City of Philadelphia, PA (2018)

[Pretreatment Practices](#). New Hampshire Stormwater Manual, Volume 2: Post-Construction Best Management Practices Selection and Design, Chapter 4-4. New Hampshire Department of Environmental Services (2008)

[Structural Pretreatment BMPs](#). Massachusetts Stormwater Handbook (Volume 2, Chapter 2). Commonwealth of Massachusetts (2008)

Design Considerations

These practices should be designed off-line to handle the first flush (initial runoff from precipitation event) for water quality improvement; a bypass line should be provided to handle larger flows. Design options include multichamber systems and devices that include vortex-induced circulating flow paths to promote sedimentation and removal of trash, oil and grease.

By attaching the inflow at a tangential angle to the cylindrical system, a swirling action is induced. Coarse sediment is removed by sliding down a cone in the center of the system to a settling chamber or by directing runoff through a screened area that traps and drops sediment into a chamber. Depending on the manufacturer, these systems can treat flows from 0.75 to 300 cubic feet per second.

In multichamber systems, typically the first chamber provides sedimentation, the subsequent chamber provides additional sedimentation and oil and grease removal (with a hood or inverted elbow), and the final chamber contains the outlet to the downstream practice (Figure 5-3). Devices should be able to safely pass the desired design storm and should include an overflow for large storms to limit resuspension of captured particles. Similar to a deep sump catch basin, the sump in the initial chamber should be at least 4 feet deep (CEI and NHDES 2008).

Maintenance Requirements

These systems require proper maintenance to limit the potential for resuspension of captured sediment. Units should be inspected after major storms and at least one per month (MADEP 2008). Units should be cleaned of captured sediment and debris twice per year. More frequent cleaning will provide more available volume for future storms and less resuspension and associated pollutant transport. The rate of sediment accumulation will depend on the site characteristics; the maintenance plans should reflect these characteristics. Because these practices could be expensive to construct and maintain, costs should be a key consideration when evaluating and selecting them.

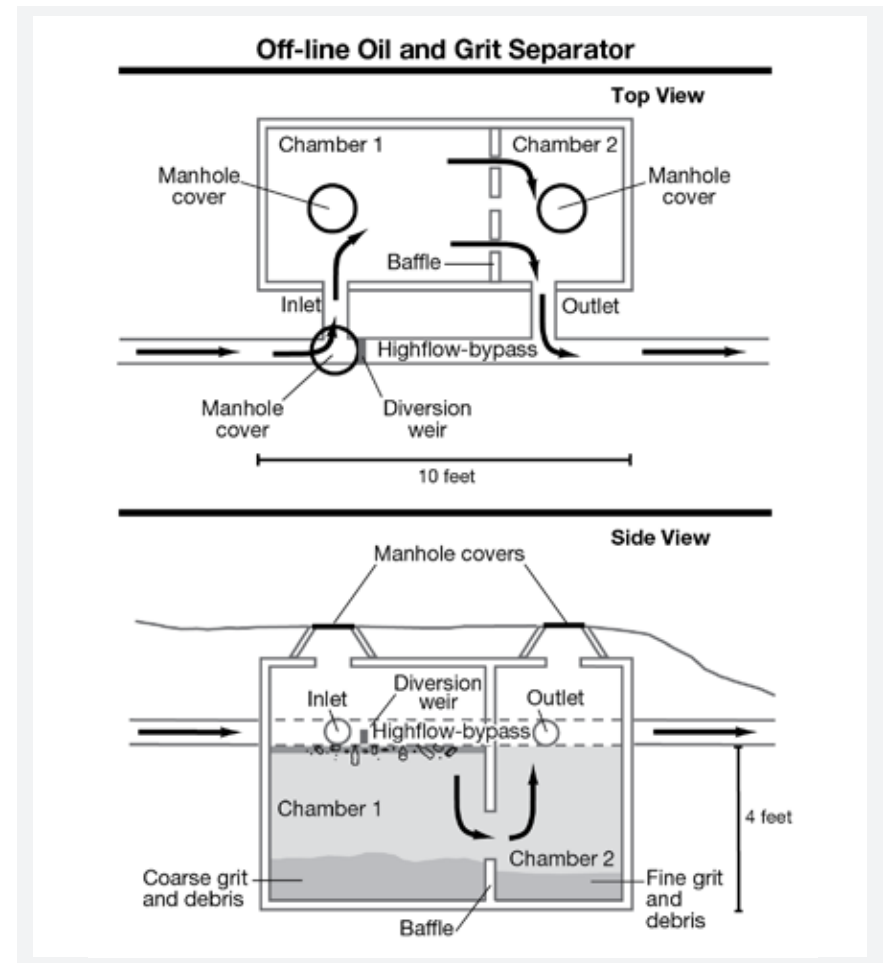

Image: After U.S. Geological Survey

Figure 5-3. An off-line oil and grit separator diverts incoming stormwater into two chambers that slow flow and allow oil and grit to separate from the water stream.

Flow-Through Structures

Key design features and maintenance needs:

- Install as an off-line device to limit potential for resuspension of captured material
- Inspect units monthly and after major storms
- Clean as needed, but at least twice per year

6

Green Street Stormwater Practices

In This Chapter

- 6.1 Bioretention (Rain Gardens)
- 6.2 Bioswales
- 6.3 Curb Extensions
- 6.4 Stormwater Planters
- 6.5 Stormwater Tree Systems
- 6.6 Infiltration Trenches
- 6.7 Subsurface Infiltration and Detention
- 6.8 Permeable Pavement

This chapter covers site design strategies and stormwater management practices that can be incorporated into street and parking lot designs for the retention and treatment of runoff. Information on pretreatment methods that should be considered and incorporated as necessary in the design of the practices and systems is included in Chapter 5. For each practice, information on siting opportunities, design details, performance and supplemental resources is provided.

Note: The design details described in this handbook are meant to be conceptual and not final design specifications. Designers should refer to state or local requirements and recommendations to inform their designs.



Sand-filled permeable pavers allow rainfall to infiltrate instead of generating erosive runoff in a sensitive coastal area in Virginia Beach, VA.

Kary Phillips, Tetra Tech, Inc.

6.1 Bioretention (Rain Gardens)

Description

A bioretention area is a shallow surface depression usually planted with native vegetation to retain, infiltrate and filter both runoff and pollutants. The volume of runoff is reduced by infiltration and retention in the soils and through interception, uptake and evapotranspiration by the plants. Peak discharges are also reduced. Physical, chemical and biological processes in plants and soils help to absorb and treat pollutants.

The form of bioretention is flexible and can be designed for collection with (1) filtration and infiltration or (2) filtration and conveyance. Once established, bioretention typically requires minimal maintenance. In-ground bioretention is typically in the form of cells, rain gardens or swales. Stormwater curb extensions, stormwater planters and bioswales use the principles of bioretention but include unique design features and are described as different green street practices in this guidebook.

Site Considerations

Bioretention has a significant advantage over other practices because it can vary in size, shape and placement. Bioretention practices can be designed to accommodate large volumes of stormwater runoff or designed to treat small drainage areas. Depending on the source of runoff, they are placed either directly adjacent to the area generating runoff or offset in sidewalks, public plazas or street medians. Bioretention can be designed as a series of multiple cells along the roadways or parking lots.

Bioretention systems can be either infiltration or flow-through systems, but should be designed with pretreatment to address potential sediment loads and debris that can be common in roadways. In ultra-urban areas or retrofit projects, bioretention might be more difficult to site due to the presence of existing infrastructure such as buildings or utilities. Design alternatives that can help overcome site constraints are discussed on the next page.

Bioretention

Advantages:

- Can be sized for large and small drainage areas.
- Good for highly impervious areas
- Good retrofit capability
- Modest maintenance requirements
- Provides aesthetic enhancement
- Reduces runoff
- Reduces pollutant load, thus reducing treatment costs
- Provides wildlife habitat

Most suitable for:

- Parking lot perimeters
- Parking lot islands
- Sidewalks
- Street frontage
- Intersections
- Road medians
- Road shoulders



Alisha Goldstein

Road runoff drains through a curb cut and into this bioretention feature on a residential front yard in Maplewood, MN.

Overcoming Site Challenges

Site constraints such as land use and environmental conditions can create perceived obstacles for implementing bioretention, however, many design alternatives are available to help overcome these challenges (Table 6-1).

Table 6-1. Bioretention: site constraints and design alternatives

Challenge	Design alternatives and recommendations
High pedestrian activity	Provide pedestrian bridges or walkways across the practice to allow for uninterrupted movement.
Sites requiring depths between 6 to 12 inches	Install barriers or additional protection around the practice as a safety provision for pedestrians.
Site slopes that are greater than 10%	Incorporate diversion berms, check dams, or terracing with weirs to allow for the bottom to be flat-sloped.
Sites near heavy traffic or high pollutant areas (i.e., potential hotspot)	Avoid placing infiltrating systems due to concerns of groundwater contamination. Recommended practices include pretreatment and/or impervious liner.
Proximity to water table	Recommended 4-foot separation to water table, with a minimum separation of 2 feet with impermeable liner and underdrain or very low-volume roadways.
Sites near sensitive areas such as building foundations or road gravel base materials or above karst topography or brownfields	Incorporate impermeable liners to direct water downward to avoid lateral flow or to prevent vertical flow to underlying sensitive areas depending on what the site requires. Provide a minimum setback of 10 feet from any foundation.
Areas that have significant salt usage or storage during winter months	Avoid using infiltrating bioretention cells in snow storage areas (especially in areas where salt is applied) due to the potential for impacting downstream environmentally sensitive areas.
Poor draining native soils (i.e., hydrologic soil groups C and D)	Amend soils or design practice with an underdrain to convey excess runoff to a downstream practice or stormwater conveyance system.
Compacted soils	Either rototill or mix compacted soil with soil amendments or entirely replace compacted soil with structural soils or modular structural cells.



Horsley Witten

Bioretention in sidewalk with protective stone wall that doubles as a bench in Washington, DC.



Horsley Witten

Roadside bioretention area includes a sidewalk bridge over the inlet to avoid obstructing pedestrian flow.

Components: Bioretention

A bioretention practice typically includes (Figure 6-1):

- Inlet (or sheet flow)
- Native vegetation, or vegetation that is resilient to both wet and dry conditions
- Bioretention soil media that includes a mixture of sand, soil and organic matter

Practices can be designed with optional features to convey inflow, manage overflow and provide pretreatment:

- Inflow structure(s) (e.g., flume, inlets, runnels)
- Highly permeable mulch layer
- Vegetated filter strip
- Forebay or ponding areas
- Outflow/overflow inlet
- Underdrain

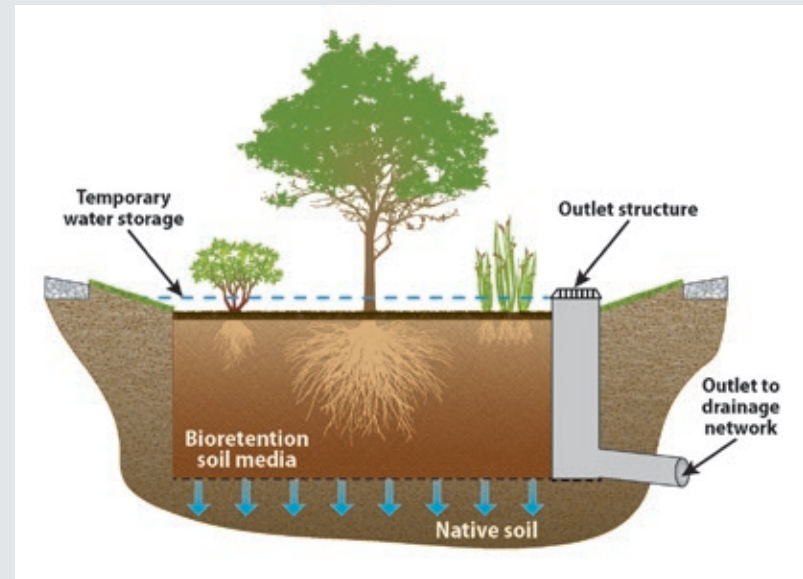

Figure 6-1. Cross-section of a common bioretention practice design.

Design Considerations

Sizing

Design considerations for bioretention cells are largely influenced by the design objective (e.g., improve water quality or provide channel protection, increase groundwater recharge, reduce peak flow) and the geographic/climatic region of the United States in which it is being applied. Bioretention cells can have many different configurations that are dependent on the land use, climate and pollutant loads. The bioretention feature should have a 2 percent or less longitudinal slope and recommended side slopes of 4:1. The cross section design can be parabolic, trapezoidal, or flat with a minimum 2-inch freeboard.

Inlet Design

For uncurbed areas, a maximum side slope of 3:1 is recommended to reduce the velocity of runoff from the paved areas and to filter out some of the sediment and finer particulates that can clog the bioretention surface. The slope vegetation should include some ground cover plants. For curbed parking lots and roads, designated inflow points must be provided where the majority of the flow will enter. Inflows should be designed to be nonerosive; energy dissipaters or diversions may be necessary to direct erosive flows away from the inlet.

Bioretention

Key Design Features:

- Flexible in size and configuration
- Maximum drainage area: 5:1, not more than 1 acre to one rain garden
- Ponding depths between 6 and 12 inches, which will allow for drawdown within 48 hours
- Plant selections that tolerate hydrologic variability, salts and environmental stress
- Amend soil as needed
- Provide overflow for extreme storm events
- Stable inflow/outflow conditions

Maintenance Requirements

Yearly inspections at a minimum are recommended to monitor infiltration and drainage. For the first 1 to 2 months of vegetation establishment, watering is recommended once every 2 to 3 days. If infiltration rates are lower than expected, it might be necessary to cultivate or replace media (top 2 to 3 inches) to improve the infiltration rate. The following activities

and minimum frequencies should be determined with regards to the specific site and as warranted by environmental conditions (Table 6-2). The maintenance cost is similar to traditional landscaping but initial training for workers may be necessary.

Table 6-2. Recommended maintenance activities for bioretention practices

	Activity	Frequency	Additional advice
Debris	Remove sediment or trash that has accumulated.	Semi-annually	If sediment loads are excessive, observe and add upstream sediment controls to lessen load.
	Inspect underdrains for obstructions.	Yearly	Remove any obstructions.
Vegetation	Cut back grasses and herbaceous vegetation. Weed invasive and exotic species, preferably using nonchemical methods such as hand pulling and hoeing. Prune trees and shrubs.	Bimonthly during establishment; yearly afterwards (preferably in early spring)	If at least 50% of vegetation coverage is not established after 2 years, provide additional plantings. When replacing vegetation, place the new plant in the same location as the old plant, or as close as possible to the old location. The exception to this recommendation is if plant mortality is due to: <ul style="list-style-type: none"> – Initial improper placement of the plant (i.e., in an area that is too wet or too dry). – If diseased/infected plant material was used and there is risk of persistence of the disease or fungus in the soil.
	Separate herbaceous vegetation rootstock when over-crowding is observed.	Every 3 years	
	Remove and replace vegetation as necessary.	Yearly (preferably in spring)	
Soil	Turn or till soil, especially if compaction occurs.	Yearly	If maintenance efforts are unsuccessful, the soil media and underdrain might need to be removed and replaced.
	Evaluate check dams for undercutting and soil substrate for channel formation.	Every 2 to 3 years (preferably in spring)	
	Remove and properly dispose of the previous mulch layer, or rototill it into the soil surface and add a new layer of mulch.	Yearly	Do not exceed 3 inches in depth for mulch layers. Avoid blocking inflow entrance points with mounded mulch or raised plantings. Once a full groundcover is established, mulching might not be necessary.
	Stabilize any areas where erosion is evident.	As needed	Determine the cause for erosion; this could require adding new features to dissipate energy or to allow the flow to bypass the practice.

Performance

Bioretention pollutant removal performance data is limited but growing in availability. Bioretention appears to be one of the most effective water quality practices given that this practice can remove many pollutants of concern; however, actual mass loading reductions will vary based on flow attenuation and influent water quality. Overall, removal of pollutants has been positively linked to the length of time the stormwater remains in contact with the herbaceous materials and soils (Colwell et al. 2000).

Data indicate that the ability of bioretention to remove total suspended solids, metals (dissolved and particulate-bound), and oil and grease is very strong, while its ability to reduce nitrogen and phosphorus has been mixed (Davis et al. 2009). Because consistent removal of excess nutrients from the pollutant stream is important when considering bioretention, more recent studies have evaluated how amendments to the media can improve adsorption rates.

For More Information—Bioretention

- Fact Sheet: [Bioretention \(Rain Gardens\)](#). City of Lancaster, PA (2011)
- Minnesota Stormwater Manual: [Bioretention](#); [Phosphorus Sorption](#). Minnesota Pollution Control Agency (2015)
- New Jersey Stormwater Best Management Practices Manual: [Bioretention Systems](#). New Jersey Department of Environmental Protection (2016)
- Stormwater BMP Manual: [Bioretention](#). North Carolina Department of Environment and Natural Resources (2018)
- Technical Guidance Manual for Puget Sound: [Chapter 6.1 Bioretention](#). Washington State University Extension and Puget Sound Partnership (2012)
- [Bioretention for Infiltration Conservation Practice Standard 1004](#). Wisconsin Department of Natural Resources (2004)
- [State-of-the-Art Review of Phosphorus Sorption Amendments in Bioretention Media: A Systematic Literature Review](#). Marvin, J.T., E. Passeport, and J. Drake (2020) (\$)



Abby Hall, USEPA

Bioretention in a residential neighborhood in Portland, OR.



Alisha Goldstein

Bioretention area outside the recreation center at the University of Florida, Gainesville, FL.

6.2 Bioswales

Description

Bioretention swales, also referred to as bioswales or vegetated swales, are typically parabolic or trapezoidal depressions that use bioretention soil media and vegetation to promote infiltration, water retention, sedimentation and pollutant removal. Bioswales differ from bioretention cells because they are designed to be conveyance treatment devices. Bioswales are typically dug to a depth of 12 to 24 inches and compost-amended; in contrast, installing a bioretention cell entails replacing the full volume of soil with an engineered planting media. Similar to traditional grassed swales that convey flows, bioswales provide additional water quality benefits because the stormwater interacts with the plants and bioretention soil. Bioswales are typically located in rights-of-way or parking lots and receive flow from adjacent impervious areas. Bioswales can be used in conjunction with pretreatment BMPs such as sediment forebays, vegetated filter strips, or other sediment-capturing devices that prevent sediments from accumulating in the swale and negatively affecting treatment and retention performance.

Site Considerations

Rights-of-way are ideal for bioswales, particularly for roads with wide shoulders or rights-of-way that have long, uninterrupted stretches of land to convey the necessary design flows (e.g., medians, the planting strip between a sidewalk and a roadway). **Because they are easy to implement and relatively low cost to construct, bioswales are applicable for both retrofits and new residential and commercial development.**

Overcoming Site Challenges

Bioswales can be designed to overcome site constraints (Table 6-3).

Table 6-3. Bioswales: site constraints and design alternatives

Challenge	Design alternatives
High pedestrian activity	Provide pedestrian bridges or walkways across bioswales to allow for uninterrupted movement.
Unsafe site depths for pedestrians	Provide barriers or additional protection around bioswale (in pedestrian areas, depths should not exceed 6 to 12 inches)
Site slopes that are greater than 5%	Incorporate terracing, diversion berms or check dams to accommodate steeper-sloping sites.

Bioswales

<p>Advantages:</p> <ul style="list-style-type: none"> - Combine stormwater treatment with conveyance - Can replace curb and gutter systems at lower cost - Mitigate peak runoff velocities - Can be sized for various layouts and topography - Reduce total suspended solids and metal concentrations 	<p>Most suitable for:</p> <ul style="list-style-type: none"> - Parking lots - Sidewalks - Road medians - Road shoulders
---	--



Grassed bioswale in New Hampshire.

Horsley Witten

Components: Bioswale

A bioswale typically consists of (Figure 6-2):

- A trapezoidal or parabolic channel
- Vegetation (dependent on site requirements)
- Bioretention soil media

Bioswales can be designed with optional features such as:

- Check dams or terracing for steeper slopes
- Curb cuts or other inlet configurations (if area is curbed)

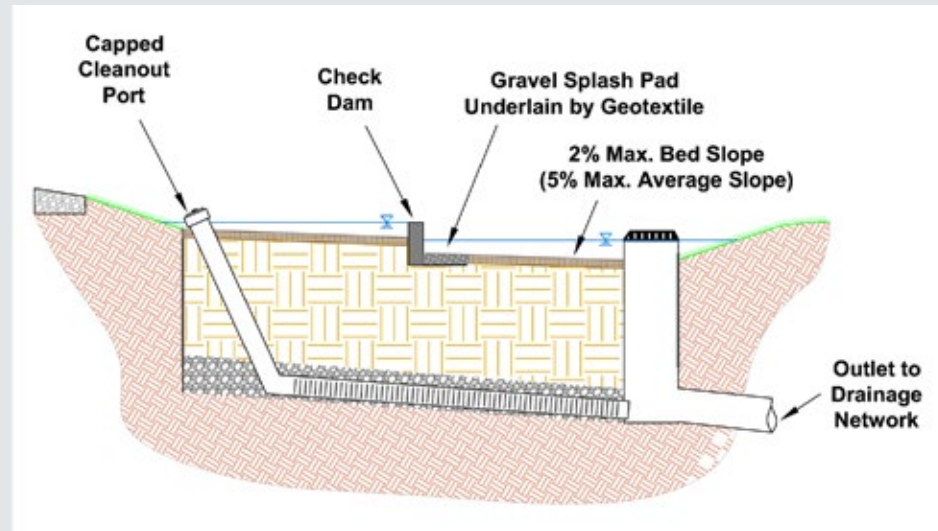

Image: Tetra Tech, Inc.

Figure 6-2. Cross-section of a bioswale designed with a check dam to control slope.

Design Considerations

Sizing

The area draining to a specific swale should typically be less than 100 feet in length and no more than 1 acre. If pretreatment is included, the maximum drainage area should be 5 acres. The bioswale should be designed to convey applicable storm events without generating erosive velocities.

Channel Geometry

The bioswale channel may be trapezoidal or parabolic in shape, with side slopes of 3:1 or flatter (note: rectangular shapes with stabilized vertical walls are generally referred to as planters; see section 6.4) and optimally a longitudinal slope with a 1 to 2 percent grade. A maximum 6-inch ponding depth is recommended. The bioswale media should be located in the center of a level area.

Inlet Design

If the perimeter of the swale is curbed, runoff can enter the swale through a curb cut opening. Inlet protection such as pea gravel or a splash pad should be installed to help dissipate the energy of the concentrated flow, thereby preventing erosion. In an uncurbed perimeter, flow may enter the bioswale as sheetflow directly or may be conveyed over a filter strip before entering the swale. If excessive sediment is expected, pretreatment such as a forebay area can also be included in the design to extend the life of the bioswale.

Bioswales

Key Design Features:

- Maximum drainage area: 5:1
- Bottom width of 2 to 8 feet
- Side slopes from 3:1 (H:V) to 5:1
- Longitudinal slope from 1% to 5%
- Maintain 0.5 to 1-foot freeboard without exceeding maximum permissible velocity
- Runoff from the designated water quality event should not overtop vegetated liner (vegetation used for treatment)
- Ensure vegetative cover is greater than 80%
- Till soil if compaction is evident

Vegetation

Bioswales can be planted with many types of vegetation, including:

- Grasses, such as turf grasses or tall grasses
- Herbaceous plants, such as sedges or rushes
- Shrubs and trees (typically found on the edges or slopes of bioswales)

Climate will affect plant selection. In drier areas, bioswales often use xeriscape vegetation. Xeriscaping is a method of landscaping that uses more drought-tolerant plantings so that minimal or no irrigation is needed in between rain events. Ideally, these plantings will also have low maintenance needs (e.g., requires no mowing or pruning). Bioswales that would receive significant quantities of salt-laden runoff should be landscaped with salt-tolerant species. Proper selection of plant species and support during establishment of vegetation should eliminate the need for fertilizers and pesticides.

Select vegetation that grows high enough to exceed desired design flow depth. Additionally, the vegetation should be moderately stiff and non-clumping to provide sufficient surface contact for water quality treatment and to avoid concentrated flow conditions. Riprap or landscape stone can also be used in bioswales, particularly at the edges to provide erosion protection.

Soils

Bioswales are usually excavated to a depth of 12 to 24 inches, tilled to improve infiltration potential, and then backfilled with a filter soil media mix (see section 4.7).

Maintenance Requirements

Bioswales should be inspected yearly at a minimum to monitor sedimentation and erosion. Bioswales planted with turf require more regular maintenance than bioswales planted with perennials and shrubs. Vegetation, including grasses, should be maintained at heights of approximately 4 to 6 inches. The maintenance cost is similar to traditional landscaping but may require initial training for workers. Follow the maintenance activities and minimum frequencies for Bioretention (see section 6.1), while also evaluating check dams for undercutting and soil substrate for channel formation (yearly).



Alisha Goldstein

Bioretention feature with grasses and flowering plants outside a public library in Cleveland, OH.



Alisha Goldstein

Bioswale designed with drought-tolerant plants in arid Tucson, AZ.

Performance

Bioswales remove pollution through three primary removal mechanisms: settling, filtering/infiltration and uptake/accumulation in plants. Using bioswales, it is possible to achieve a 40 percent annual runoff volume reduction (CWP and CSN, 2008; CWP 2007). Current data suggest that bioswales are effective in removing suspended solids. In contrast, studies have shown that bacteria levels are increased in the bioswale effluent. A possible explanation for the introduction of bacteria is waste from wildlife and the pets of nearby resident. Performance is improved when bioswales are built with a pretreatment device such as a filter strips because the sheet flows from parking lots or roadways are diffused.

For More Information—Bioswales

[Biofiltration Swale: Design Guidance](#). California Department of Transportation (2012)

[Standards for Green Infrastructure](#). City of New York Department of Environmental Protection (2020)

[Biofilters for Storm Water Discharge Pollution Removal](#). Oregon Department of Environmental Quality (2003)



Jason Wright, Tetra Tech, Inc.

Roadside bioswale with curb-cut inlet in Greensboro, NC.



Jason Wright, Tetra Tech, Inc.

Bioswale at Los Angeles Zoo parking lot.



Abby Hall, USEPA

Bioswale next to a permeable pavement sidewalk in Seattle, WA.



Martina Frey, Tetra Tech, Inc.

Parking lot bioswale conveys runoff from a parking lot in Wilsonville, OR.

6.3 Stormwater Curb Extensions

Description

Stormwater curb extensions, also called stormwater bump outs, are modified traffic-calming devices that extend the curb into the roadway to reduce traffic speed and capture stormwater runoff from roadways and/or sidewalks. The area behind the curb is filled with a bioretention soil mix and vegetation similar to a bioretention cell or bioswale. The vegetation can be groundcover, shrubs or trees depending on site conditions, costs and design context.

This green infrastructure practice provides stormwater treatment and retention within the right-of-way. Curb extensions can be designed in several configurations to provide both filtration and retention. Pretreatment practices such as vegetated filters and sediment traps are recommended upstream of this practice.

Site Considerations

Stormwater curb extensions can be incorporated in new development and offer an ideal retrofit approach for existing streets. They can be installed upstream of storm sewer inlets and without any modifications to existing catch basins. Overflow from curb extensions can continue to flow down the street to storm sewer inlets. Their small footprint presents minimal disturbance to rights-of-way and provides flexibility in siting. Stormwater curb extensions can be placed in multiple locations along a street section or at intersections to minimize impact to parking (Figure 6-3). They are relatively inexpensive and, when sized correctly, are often capable of treating the entire runoff volume from the street on which they are located.

Implementing stormwater curb extensions can meet additional goals such as traffic calming. The presence of curb extensions narrows the pedestrian crossing distance, increases visibility of pedestrians, and has been shown to reduce vehicular speeds. They are also suitable in areas with steep-slope conditions because they can provide a 'backstop' for stormwater runoff. In addition, they provide landscaping opportunities to beautify the neighborhood.

Stormwater Curb Extensions

Advantages:

- Provides traffic calming and improves pedestrian safety
- Enhances site aesthetics
- Offers air quality and climate benefits that improve environmental health
- Reduces total volumetric runoff
- Provides water quality treatment

- Presents minimal disturbance to the area and existing infrastructure
- Reduces effective impervious area

Most suitable for:

- Neighborhood streets and some collectors
- Intersection
- Midblock
- Any length of roadway

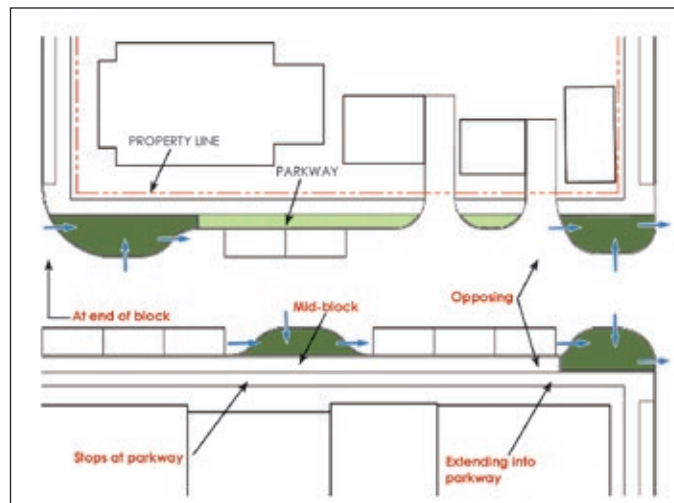

Image: Tetra Tech, Inc.



John Kosco, Tetra Tech, Inc.

Figure 6-3. Potential locations for curb extension practices.

Stormwater curb extension in State College, PA.

Overcoming Site Challenges

Stormwater curb extensions can be designed to overcome site constraints such as sloped landscapes and the presence of underlying utilities, while also enhancing safety and minimizing the loss of parking spaces. Common site challenges and design alternatives are described in Table 6-4.

Table 6-4. Stormwater curb extensions: site constraints and design alternatives

Challenge	Design alternatives and recommendations
Removal of on-street parking is required.	Minimize impact by selectively placing curb extensions at intersections or mid-block crossings.
Ensure safety for all modes of transportation.	Be conscious of street width, turning radii and sightlines for all users.
Prevent vehicles from driving onto the sidewalk and harming pedestrians.	Provide barriers such as bollards, planters or benches around stormwater curb extension.
Site slopes that are greater than 5%.	Incorporate terracing, diversion berms, or check dams to accommodate steeper-sloping sites.
Sites that are not stable or have high sediment loads.	Plan to include pretreatment practices to avoid high amounts of maintenance.
Conflict with underlying utility or fire hydrant.	Reorient the design.
Proximity to water table.	Recommended a 4-foot separation to water table with a minimum separation of 2 feet.

For More Information—Stormwater Curb Extensions

[Northeast Fremont Street Green Street Project](#). City of Portland Bureau of Environmental Services (2007)

[San Francisco Better Streets: Curb Extensions \(Bulb-outs\)](#). City and County of San Francisco (2015)

[City of Philadelphia Green Streets Design Manual](#). City of Philadelphia (2014)

[Tennessee Permanent Stormwater Management and Design Guidance Manual: Urban Bioretention](#). Tennessee Department of Environment and Conservation (2015)



Alisha Goldstein

Parking impacts minimized by using a mid-street stormwater curb extension in the Barton Creek neighborhood, Seattle, WA.



Alisha Goldstein

Black and yellow-striped bollards placed around a stormwater curb extension ensures safety for motorists in Tucson, AZ.

Components: Stormwater Curb Extension

A stormwater curb extension typically consists of (Figure 6-4):

- Low-profile vegetation
- Curb cuts (berms, inlet deflectors or pavement modifications are often used to direct flow towards curb-cut inlets)
- Bioretention soil media

Stormwater curb extensions can be designed with optional features such as:

- Forebays
- Check dams or terracing for steeper slopes
- Underdrains
- Overflow structures

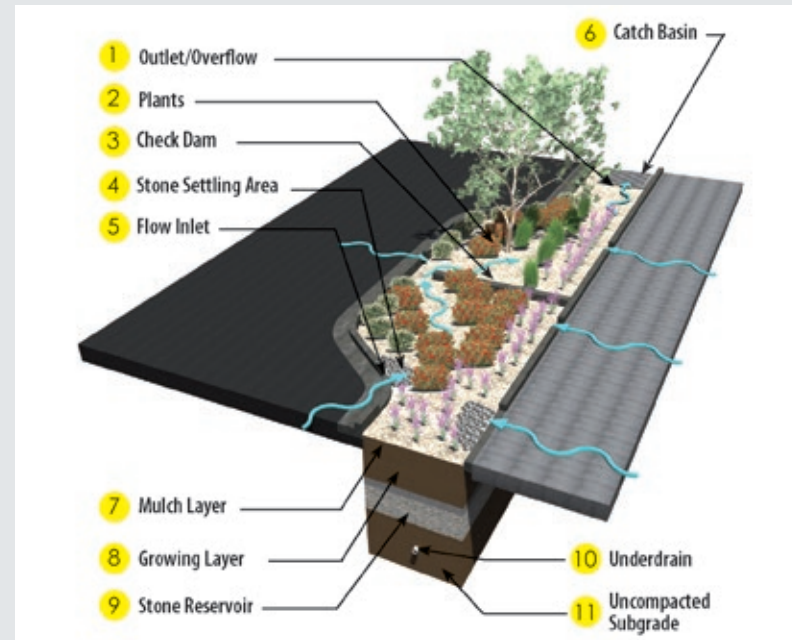

Image: Tetra Tech, Inc.

Figure 6-4. Components of a stormwater curb extension.

Design Considerations

Inlet Design

Runoff for uncurbed roads and sidewalks is generally conveyed via direct sheet flow or shallow concentrated flow into stormwater curb extensions; curbed roads and sidewalks require curb cuts to direct the flow. Alternatively, runoff may enter via an existing or proposed inlet, typically located at a low point or depression in a road or parking lot.

A curb cut should be made where the majority of the flow will enter; in some cases, more than one curb cut might be necessary to capture flows from multiple locations. For more information on curb cuts, see section 4.4.

Berms, inlet deflectors, or pavement modifications (e.g., depressions), can be used to direct flow to the curb cuts or inlets (particularly those at a 90-degree angle). The following elements should be evaluated when determining the dimensions and shape of the curb cut opening: ponding

depth, spread of flow, slope and design storm event. To protect the media around the inlet from scouring and erosion, a concrete splash pad or a course of riprap or gravel should be installed just inside the curb cut to dissipate the flow as it enters.

A curb opening can be designed with a forebay structure to capture sediment. Concrete pads are typically used as forebays to help remove sediments. Hand removal of sediments from a small concrete pad is much easier than removing sediments from a mulch and soil layer or a pretreatment forebay filled with stone or gravel.

Stormwater Curb Extensions

Key Design Features

- Include low-profile vegetation
- Level storage bed bottoms
- Mark curb cuts to be highly visible to motorists
- Work around existing utilities
- Refer to bioretention key design features

Sizing

The surface area of the curb extensions is typically 5 to 10 percent of the drainage area.

Underdrains

Stormwater curb extensions can be designed with or without an underdrain. Systems with poor underlying soil typically include an underdrain to ensure drainage within a set time period. The underdrain can be placed a few feet above the bottom of the practice to create internal water storage to promote infiltration. Even with this storage layer, practices with underdrains provide less water quantity reduction than practices without them.

Overflows

Overflows are typically conveyed through an overflow curb cut at the downstream end of a curb extension. If an overflow structure is incorporated into the design (typically with an underdrain), it should be sized to pass the design storm event. Grates on the top of overflow inlets should be sized to exclude trash and animals while allowing stormwater to drain at a steady pace. The structure should be large enough to provide access to clean out the outflow pipe or the underdrain. The top of the overflow structure should be at the maximum ponding depth.

Vegetation

Vegetation selection for stormwater curb extensions is similar to a bioretention cell (see section 6.1). Selected vegetation should be low profile (typically 36 inches or less at maturity) to allow unimpeded sightlines for pedestrians and motorists.

Soils

Native soils are typically excavated to a depth of 18 to 24 inches and tilled to improve infiltration potential. The curb extension is then backfilled with a bioretention filter media mix.



USEPA

Runoff enters the upper end of this curb extension, and the overflow volume exits through an opening on the lower end and drops into a storm drain.



Horsley Witten

Densely planted low-growing grasses fill a stormwater curb extension in Portland, OR.



Martina Frey, Tetra Tech, Inc.

Mature grasses and a tree pit treat stormwater in a curb extension in Gresham, OR.

Maintenance Requirements

Maintenance of curb extensions is similar to that of a bioretention practice (see section 6.1) In addition, evaluate the condition of curb extension perimeter and inflow/outflow points. Repair or replace as needed. Yearly inspections are recommended at a minimum.

Performance

Similar to bioretention cells, stormwater curb extensions use the physical, chemical and biological processes in plants and soils to absorb and treat pollutants and help maintain the hydrologic balance of an area. Research has shown that stormwater curb extensions are highly efficient at removing pollutants, with results similar to a bioretention cell. Refer to the performance statistics for bioretention in section 6.1 for more information.

Stormwater curb extensions promote stormwater infiltration and retention in the soils, as well as interception, uptake and evapotranspiration by the plants. As a result, curb extensions are able to provide significant reductions in both peak flow rates and annual stormwater volume.



Tetra Tech, Inc.

Stormwater curb extension decreases crossing distance and improves intersection safety in the Capitol Hill neighborhood in Seattle, WA.



Jason Wright, Tetra Tech, Inc.

Mid-street stormwater curb extension in a neighborhood in Kansas City, MO.



Abby Hall, USEPA

End-of-street stormwater curb extensions in a neighborhood in Portland, OR.

6.4 Stormwater Planters

Description

Stormwater planters are becoming common components of municipal stormwater programs. Planters are narrow, flat-bottomed landscape areas that are typically rectangular in shape with vertical walls. Planters usually receive runoff from surrounding impervious areas, including rooftop areas, sidewalks and roadways. Constructed from a variety of different materials, they can be configured in different ways to effectively capture and treat incoming flows. The two primary types of planter boxes are:

- **Infiltration planters.** These have open bottoms and allow stormwater to infiltrate into the subsoil beneath. As stormwater percolates through the planter box soil, pollutants are removed by filtration, absorption and adsorption, and chemical and biological uptake. Infiltration planters are appropriate to use in well-drained soils. Infiltration planters have a greater potential for runoff reduction than do flow-through planters.
- **Flow-through planters.** These have impervious bottoms or are placed on impervious surfaces. Once the soil in flow-through planters is saturated, excess water is collected in an underdrain to be discharged to the conveyance system or to another green infrastructure practice. They are appropriate for soils with poor drainage, prior contamination or high seasonal groundwater table.

Site Considerations

Stormwater planters are ideal for urban or ultra-urban areas where space is limited or in areas with steep slopes. Planters are also ideal for retrofit projects because they can be built between driveways, entryways, utilities and trees, adjacent to buildings and parking lots, and in rights-of-way. They can be used to capture surface runoff from roadways or be connected to a downspout from a rooftop. They should be placed reasonably close to the source of runoff.

Planters can be situated either aboveground (receiving water via surface flow) or belowground (receiving water via underdrains). In rights-of-way, aboveground planters can be designed with a perimeter seating for pedestrians. Belowground planters can be equipped with fences and/or adjacent benches to provide a pedestrian-oriented streetscape. They can be built singularly or in series.

Stormwater planters are typically not used in low- to medium-density settings because the hardscape infrastructure required increases the cost of the practice, so it is generally not as cost effective as bioretention or bioswales. Planters are typically used in areas where site constraints and right-of-way use patterns require confined and protected practices. Because these practices are normally in urban places where space is a constraint, their performance is limited by the capacity of the planter.

Stormwater Planters

Advantages:

- Enhance site aesthetics
- Reduce total volumetric runoff
- Provide some water quality treatment
- Reduce effective impervious area
- Widely applicability in ultra-urban areas

Most suitable* for:

- Sidewalk areas
- Buffer zone between sidewalk and street
- Areas with expanses of impervious surface where bioretention is not an option

* Typically applied in urban locations



Horsley Witten

Curb cuts in the sidewalk and street allow for runoff to flow into this stormwater planter in Portland, OR.

Overcoming Site Challenges

Stormwater planters can be designed to overcome site challenges such as high pedestrian activity, safety concerns, or high-sediment-load runoff (Table 6-5).

Table 6-5. Stormwater planters: site constraints and design alternatives

Challenge	Design alternatives and recommendations
High pedestrian activity or vehicle traffic.	Provide pedestrian bridges to allow for crossings in the sidewalk. Aboveground planters can provide a seat wall for pedestrians.
Belowground planters are perceived as safety risk for pedestrians.	Install tree fences, barriers and/or benches to provide protection around planter.
Sites that are not stable or have high sediment loads.	Incorporate pretreatment practices to avoid high amounts of maintenance.



USEPA

Sidewalk planters are equipped with bridges to provide access to parking areas in Seattle, WA.



Horsley Witten

Interconnected stormwater planters include protective walls alongside the parking lane in Niagara Falls, NY.



Kary Phillips, Tetra Tech, Inc.

A pedestrian-friendly sidewalk planter includes safety rails and a metal sidewalk bridge in Baltimore, MD.

Components: Stormwater Planter

A stormwater planter typically consists of (Figure 6-5):

- Vertical walls, typically made of a durable material that is context-appropriate
- Access point such as a curb cut or downspout connection
- Vegetation
- Bioretention soil media

Stormwater curb extensions can be designed with optional features such as:

- Splash pad
- Underdrains
- Overflow structures
- Liners

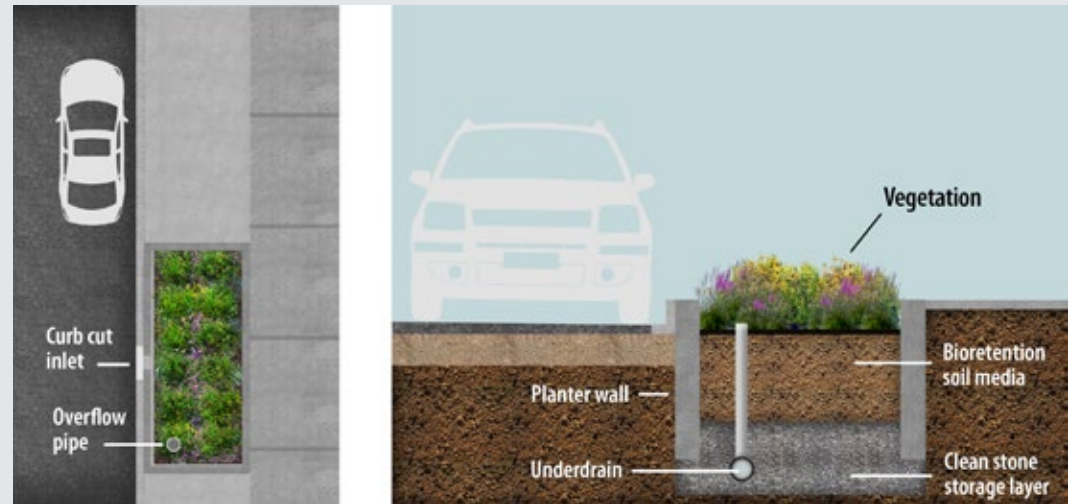

Image Credit: Valley Conservation

Figure 6-5. Stormwater planters, unit plan view (left) and cross section (right).

Design Considerations

Hardscape Materials

Stormwater planters may be constructed of any durable material, such as stone, concrete, brick, plastic lumber or wood. Stand-alone planter boxes are typically constructed of pre-cast or cast-in-place concrete or other materials used in the nearby streetscape.

Sizing

Stormwater planters should be sized appropriately for storage volume requirements and available space. The space needed for planter boxes might not be available in all situations within the urban environments. Minimum sizing requirements will depend on local stormwater regulations. A typical planter box may have an interior size of 2 feet by 2 feet with a depth of 12 inches (of which 6 inches is for storage depth) and slope of less than 0.5 percent. For infiltration planters, at least 2 feet of infiltration medium should be included between the bottom of the practice and any underlying constraint (e.g., solid rock, high groundwater table).

Inlet Design

Planters placed in rights-of-way typically have curb cut inlets that capture flows from roadways and/or have notches in the planter walls to receive sidewalk runoff. Planters that are installed adjacent to buildings receive flows from downspouts; to reduce scour and erosion, these inlets typically have a splash pad or a course of stone at the base to dissipate flow energy.

Liners

Flow-through planters typically use an impermeable liner or other impervious bottom to prevent runoff from infiltrating into native subsoils. Planters that are adjacent to buildings should also have a waterproofing membrane on the sides of the planter to protect the building's foundation.

Stormwater Planters

Key Design Features

- Infiltration rate of soil will determine size and site applicability
- Runoff should drain within 3 to 4 hours after storm event
- Provide a flow bypass for winter conditions

Vegetation

Vegetation selection for stormwater planters is similar to a bioretention cell (see section 6.1). They generally include a variety of shrubs, small trees and native herbaceous species that are appropriate for the streetscape. Some designers are using sedum and other green roof plants (e.g., the National Institute of Medicine in Bethesda, MD).

Soils

Belowground stormwater planters are typically excavated to a depth of 18 to 24 inches and tilled to improve infiltration potential or back-filled with a bioretention soil mix. Use backfill to enhance infiltration, especially if the native soils do not have a minimum infiltration rate of 0.5 inches per hour. Aboveground stormwater planters are filled with 18 to 24 inches of a bioretention soil mix.

Performance

Stormwater planters exhibit water quality benefits similar to those of bioretention, which mimic nature by employing a rich diversity of native plant types and species. In addition to improving water quality and reducing runoff quantity, the locally adapted vegetation exhibits good tolerance to pests, diseases and other environmental stressors.



Robert Goo, USEPA

Stormwater planters in Washington, DC, are designed in a series to collect and treat road runoff while allowing adequate pedestrian access to the street and sidewalk.

Maintenance Requirements

The maintenance requirements for a planter are influenced by site conditions such as frequency of sediment build-up or growth of vegetation. The maintenance activities and frequencies outlined for bioretention (see section 6.1) should be followed for stormwater planters. Inspect the planter box for structural integrity at least yearly.

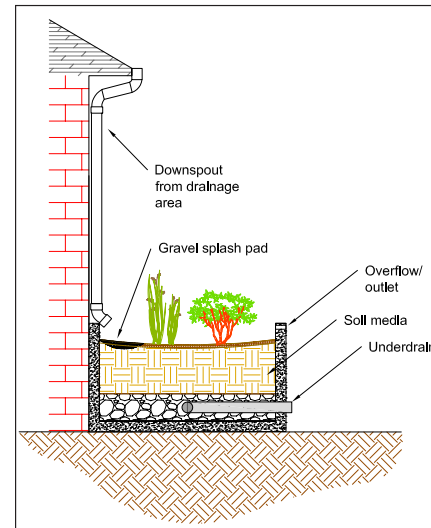

Image: Tetra Tech, Inc.

A stormwater planter can be designed to capture and treat roof runoff.



Abby Hall, USEPA

Roof downspout is directed into a stormwater planter in Emeryville, CA.

For More Information—Stormwater Planters

[City of Philadelphia Green Streets Design Manual](#). City of Philadelphia (2014)

[Stormwater Planters](#). Oregon State University Extension Service (2018)

[Low Impact Development Approaches Handbook: Flow-Through Planter](#). Oregon Clean Water Services (2009)

6.5 Stormwater Tree Systems

Description

Stormwater tree systems (i.e., pits and trenches) consist of a tree or shrub, bioretention soil media, and a gravel reservoir to intercept and capture stormwater. The tree pit can be designed as an infiltration practice. If infiltration is not desirable because of a groundwater contamination threat, poorly draining native soils, or a high groundwater table, systems can be designed with an underdrain that directs treated runoff to a downstream practice or stormwater conveyance system.

Stormwater tree systems typically receive road runoff through a curb cut, catch basin or stormwater inlet. Captured runoff temporarily ponds on the surface before infiltrating and filtering through a bioretention soil media and/or a stone reservoir. These practices improve water quality through filtration and adsorption, reduce peak discharge through subsurface storage, and can reduce runoff volume through the uptake and evapotranspiration by trees. If designed for infiltration, these practices achieve additional reductions of runoff and peak flow. Types of stormwater tree systems include:

- **Tree Pits.** Stormwater tree pits are typically installed upstream of existing catch basins to improve water quality through filtration and adsorption before directing runoff to a downstream stormwater management practice or conveyance system. Unlike tree trenches, tree pits only include one tree or shrub. A number of proprietary tree pit systems on the market include pretreatment sumps and/or subsurface structural supports. These structural elements preserve volume for soil media while also providing support for sidewalks.
- **Expanded Tree Pit.** An expanded tree pit has a contiguous bioretention cell designed to collect and treat stormwater. It is also referred to as a tree box filter, tree box, or bioretention tree pit. Because these systems generally have surface volumes that permit ponding, they achieve more stormwater reduction and treatment than tree pits. Tree pits have an average lifespan of 25 years, although vegetation might need to be replaced more frequently (LIDC 2005).

Stormwater Tree Systems

Advantages:

- Reduce runoff volume and delay peak flows
- Enhance site aesthetics
- Shade and shelter individuals and buildings
- Reduce air temperature
- Reduce cooling and heating costs
- Capture/reduce air pollutants
- Evapotranspire runoff

- Reduce noise pollution
- Improve psychological health
- Provide a sense of place
- Simple to install
- Available in multiple sizes

Most suitable* for:

- Sidewalk areas
- Buffer zone between sidewalk and street
- Medians
- Parking lots

* Typically applied in urban locations

- **Tree Trench.** The stormwater tree trench is a variation of the tree pit. Tree trenches include a stone storage layer, bioretention soil media and multiple trees planted in sequence with a common gravel trench for water storage. Tree trenches are most commonly designed as off-line structures. Multiple design variations are available, but typically a catch basin captures runoff and conveys it through a perforated pipe in the gravel trench. Water is stored in the trench and is taken up by the trees and the underlying soil, if designed for infiltration.



Horsley Witten

A tree pit captures runoff in a parking lot in Lawrence, KS.

Overcoming Site Challenges

Stormwater tree systems can be designed to overcome site challenges such as a high groundwater table, insufficient soil volume or concerns for soil upheaval (Table 6-6).

Table 6-6. Stormwater tree systems: site constraints and design alternatives

Challenge	Design alternatives and recommendations
High groundwater table or poor-draining native soils	Design practice with an underdrain to convey excess runoff to a downstream practice or stormwater conveyance system.
Compacted soils	Either rototill or mix compacted soil with soil amendments, or entirely replace soil with structural soils or modular structural cells.
Tree pit depths great enough to pose a pedestrian fall risk	Install fences, barrier and/or benches to provide protection around the tree pit.
Underground or aboveground utility present	Select trees with mature heights under the average height of overhead utilities (typically 30 feet). Provide adequate clearance of underground utilities, which should be protected from water and root penetration.
Insufficient soil volume to ensure proper tree growth	Construct root paths to an adjacent open space or add structural cells that can support sidewalks or pavement while providing space for soil below ground.
Proximity to buildings	Incorporate an impermeable liner or underdrain into the design to prevent infiltration into the building foundation.
Limited sidewalk width	When necessary, place paving stones, cobbles, or porous rubber as a surface material around the trees outside the root ball area.
Concern for sidewalk upheaval	Provide areas for unrestricted root growth beneath the surface using root paths or structural soils below the sidewalk. Ensure that trees are planted below grade.

Site Considerations

Tree pits and tree trenches are ideal for urban and ultra-urban environments because they help to reduce the urban heat island effect, improve air quality, enhance community aesthetics and create a walkable environment that is safe, healthy and comfortable. Street trees can induce traffic calming if planted to create vertical walls that frame the street and guide motorists along a defined edge, or if they are planted in street medians to better divide opposing traffic flows (Burden 2006).

Tree pits and tree trenches are widely applied in retrofit situations because they can be installed within the sidewalk (although the sidewalk must not be encroached upon to a point that pedestrian traffic is affected). These practices are most commonly seen on sidewalks of urban or commercial streets; however, they are also applicable in parking lots.

Expanded tree boxes are another practice worth considering. This practice involves the use of a vault or other structural device to provide larger volumes for additional retention and room for the tree roots to expand. The use of these systems promotes the growth of healthy mature trees and can provide significant stormwater retention or detention volume.

Because of their relatively rigid shape, these practices are not typically suitable in residential or rural applications, where more natural-looking practices such as bioswales or bioretention practices are generally more appropriate and cost-effective. Tree pits can be part of a treatment train and can receive inflow from a pretreatment practice to enhance sediment and trash removal.

Design Considerations

Siting

Evaluating existing site conditions, such as soils, hydrology, topography, vegetation patterns and invasive species, is necessary to determine the proper placement and design requirements for planting a tree. For example, minimal availability of planting surface areas would influence species selection and require soil modification to support plant growth and health. Plants should be located as far from the curb as possible to prevent injury from salt, sand and snow. Along roadways, it is important to anticipate activities such as mowing and snow storage when siting trees.

There must be a setback from the road to maintain line-of-sight requirements, including for street signs, signals and lights—especially at intersections, curb cuts and medians.

Slope

For longitudinal slopes greater than 5:1 (H:V), consider a terraced approach.

Hardscape Materials

A number of design options are available for the tree pit enclosure. To maximize root growth, shallow concrete barriers can define the edge of the practices, allowing for uninhibited root growth in all directions and maximizing infiltration. Enclosed vaults may be used where infiltration is not desirable, where there is soil or groundwater contamination, or where a high groundwater table is a concern. Vaults used in tree pits can be rectangular or cylindrical. Other design variations include bottomless tree vaults or vaults with some sides left open to encourage root growth.

Stormwater Tree Systems

Key Design Features

- Select appropriate tree species
- Allow sufficient root zone growth area
- Provide mechanism for funneling stormwater runoff to the tree
- Ensure proper spacing and avoid conflicts with utilities, buildings and pedestrian traffic
- Provide high infiltrative capacity to prevent ponding after 72 hours

Components: Tree Systems

Although there are many design variations, a stormwater tree system (Figure 6-6) typically consists of:

- Tree boxes
- One or more trees or shrubs
- Bioretention soil media
- Gravel reservoir
- An underdrain

Optional design components include:

- Pretreatment sump
- Impermeable liner
- Connection to subsurface chambers
- Observation well (if needed)
- Overflow outlet

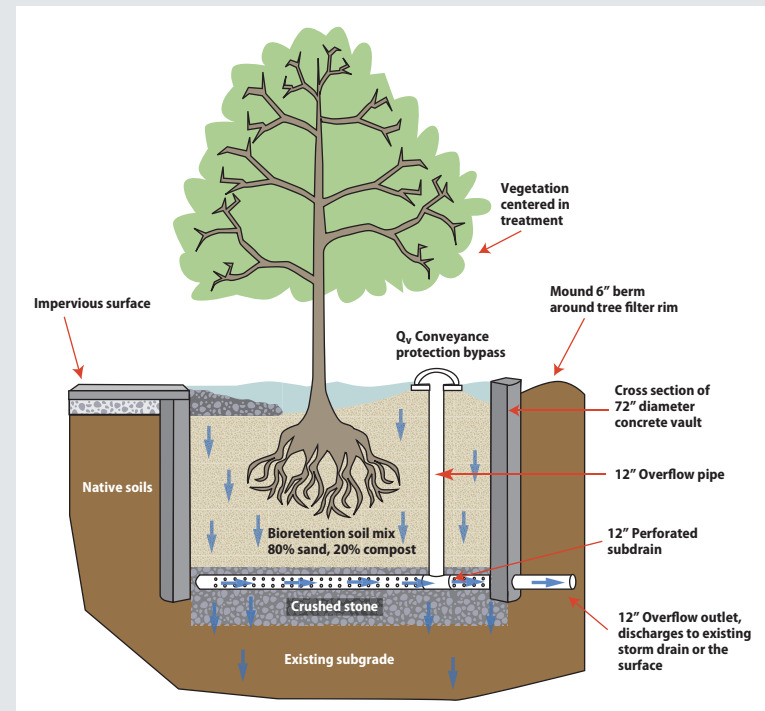

Figure 6-6. Stormwater tree pit schematic.

Space Requirements

To reach mature growth, trees require sufficient soil volume with ample void space. The recommended soil volumes depend on the size and the number of trees sharing the soil bed. Although no universal standard for soil volume requirements for expected mature tree size exists in arboriculture, it is generally accepted that a large-sized tree (16 inches diameter at breast height) needs at least 1,000 cubic feet of uncompacted soil (USEPA 2013). If soil volume is insufficient for root establishment, tree growth will be stunted and roots may be forced to grow upward, causing heaves in the sidewalk. If retention is an objective, sufficient volume for tree root growth and continued retention should be included in the design.

Different designs can be used separately or in conjunction with one another in challenging situations (i.e., utility conflicts or limited sidewalk area) to provide ample space.

- The tree is surrounded by an open, unpaved soil area that can be planted or covered with mulch. This method requires more street space than the other two methods.
- The tree is provided with root paths that use aeration or drainage strips to guide root growth under the pavement. Root paths may connect adjacent green spaces.
- The tree is provided with a specially designed soil area to promote root growth under the pavement. A variety of solid and permeable pavements can be used to cover the soil. The underlying soil may consist of structural soils or modular structural cells.

Structural or soils cells offer void space for root growth while providing load support to meet pavement design requirements. Structural soils are composed of crushed stone, clay loam and a hydrogel stabilizing agent, which can be compacted to meet pavement design requirements. The stone provides void space for root growth.

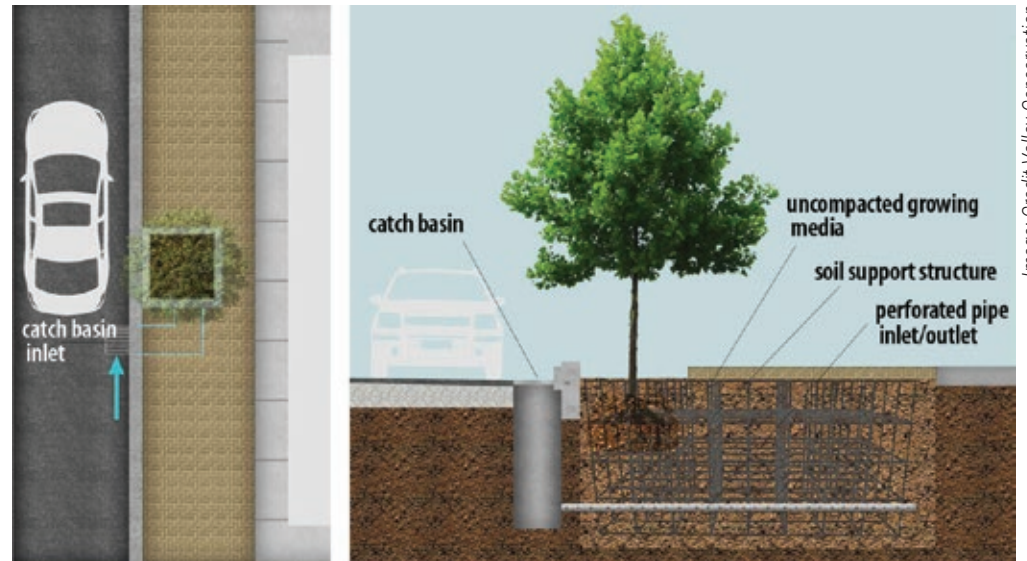

Figure 6-7. Cross section of tree box with a structural support system under the sidewalk.

Modular structural cells are typically constructed of plastic or fiberglass and are designed to support pavement and loading requirements (Figure 6-7). Soil is added to the cell framework, which provides structural support for root growth. Structural cells are more commonly used in locations that have inadequate volumes of soil for tree growth or where highly compacted soils do not allow for root growth (typically under paved areas).

Optional Design Considerations

Alternative designs can help accommodate site-specific conditions or goals. In addition to the enclosed vault option cited above, an impermeable liner around the sides and on the bottom can be combined with an underdrain system to inhibit infiltration in cases where foundation flooding problems or the presence of underground utilities or contaminated soils make infiltration undesirable. Setbacks to existing buildings and foundations should be considered when determining the desirability of infiltration. Tree pits and tree trenches can be designed to connect to subsurface infiltration structures to provide additional storage and groundwater recharge. Additionally, planting trees in groups can reduce wind impacts and create shade.

Inlet

Water typically enters tree trenches through a catch basin, but can also enter from curb inlet or from permeable paving on the sidewalk above the storage trench. The stormwater then flows through a perforated distribution pipe or an underdrain into the filter media.

Underdrains

Tree pits are typically designed with an underdrain to provide filtration of small volumes of stormwater before discharging to the existing storm drain system or a downstream practice. Where soils have an infiltration rate greater than 0.5-inch per hour, tree pits can be designed to infiltrate (and underdrains are not needed). However, underdrains may be advisable when there is an underground conflict with utilities or issues with potential groundwater contamination due to resident soils. If adjacent land uses have a high potential to discharge soluble pollutants of concern, infiltration systems might not be appropriate.

Vegetation

Tree pits contain a single tree or shrub; tree trenches could contain multiple trees or shrubs in series. Native vegetation species should be

Reforestation and Afforestation

Improving the tree canopy on a large scale can be a form of reforestation or afforestation. Reforestation is the replacement of trees that were previously lost to construction or deforestation. Afforestation is the planting of a new tree community in an area where they have been absent for a significant period of time, such as an old farm field (Prince George's County 2005). These practices involve planting trees on existing turf or barren ground, with the goal of establishing a mature forest canopy that will intercept rainfall, increase evapotranspiration rates and enhance soil infiltration rates. Reforestation and afforestation require large land areas and are therefore most suited for sites near existing forests, along waterways or steep slopes, and along existing highways or other roads.

selected based on soil conditions and the historic plant community in the area. To provide maximum tree canopy benefits, street trees should be planted near each other whenever possible while maintaining sufficient area for each tree's individual root growth. For sites in cold climates near roadways, it is essential to select trees that have a high tolerance for pollutants and salt. Salt spray has been shown to affect areas over 30 feet away from the road (MHD 2006). Potential thermal impacts from adjacent structures should also be evaluated when selecting tree species and designing tree box planters.

Ideally for reforestation and afforestation, plantings should provide a multi-layer canopy structure of about 50 percent large trees and 50 percent small trees and shrubs (Hinman 2005). Using a diversity of plant types and sizes (e.g., evergreens, deciduous trees, shrubs) will increase the pest and disease resistance (MHD 2006). For many sites, a ratio of two evergreens to one deciduous tree will provide a mix similar to native forests (Hinman 2005).

To foster a forest-type microclimate on altered, disturbed landscapes, pioneer species that thrive in infertile soils can be planted first. Establishing these faster-growing varieties of plants before others mimics the natural succession pattern and will create an environment that will provide shade cover to enable more difficult-to-establish species to develop (MHD 2006).



Stormwater catch basin tree pit, Charlottesville, VA.

Kary Phillips, Tetra Tech, Inc.

Soils

In addition to the space requirements mentioned earlier, soils should remain uncompacted so water and nutrients can infiltrate into void spaces. It might be necessary to enhance the existing soil with fertile topsoil, especially for reforestation projects. To increase the permeability of native soil, a compost-amended soil can be added. Care should be taken to prevent soil compaction during planting.

Structural soils are engineered soil-on-gravel mixes that are designed to support tree growth and serve as a sub-base for pavements. They are typically 70% to 80% angular gravel, 20% to 30% clay loam soil and a small amount of hydrogel (~3%), which provides 20% to 25% void space.

Bioretention soil mixes are commonly used for extended tree pits. The University of New Hampshire Stormwater Center (UNHSC) recommends a bioretention soil mix that is comprised of 80% sand and 20% compost to maximize permeability while providing minimum organic content. UNHSC also recommends 3 feet of bioretention soil mix. Supporting material for the *Minnesota Stormwater Manual* suggests 50% to 65% coarse sand, 25% to 35% topsoil and 10% to 15% compost (MPCA 2013).

Performance

Trees retain water, improve water quality and offer many other community benefits when properly planted. Trees generally absorb the first 30% of precipitation events through their leaf system and release it through evaporation. Up to an additional 30% of precipitation is absorbed into the ground and is taken in and held by the root structure before being absorbed and released to the air as transpiration (Burden 2006). Trees also enhance water quality by using nutrients for plant processes at the surface and within the soil media. The soil matrix removes pollutants as well through chemical binding of charged particulates, biological uptake by microbial communities in the soils and physical removal through filtration.



Tree pits treat stormwater runoff at a park in Portland, OR.

For More Information—Stormwater Tree Systems

[Urban Street Trees- 22 Benefits Specific Applications](#). Dan Burden, Glattig Jackson and Walkable Communities, Inc. (2006)

[Stormwater, Trees, and the Urban Environment](#). Charles River Watershed Association (2009)

[Minnesota Stormwater Manual: Trees](#). Minnesota Pollution Control Agency (2013)

[Green Infrastructure Practices: Tree Boxes \(Fact Sheet FS1209\)](#). Rutgers University Cooperative Extension, New Jersey Agricultural Experiment Station (2013)

[Regular Inspection and Maintenance Guidance for Bioretention Systems/Tree Filters](#). University of New Hampshire Stormwater Center (2009)

[Stormwater to Street Trees: Engineering Urban Forests for Stormwater Management](#). USEPA Office of Wetlands, Oceans and Watersheds (2013)

[Stormwater Trees: Technical Memorandum](#). USEPA Great Lakes National Program Office (2016)

[i-Tree: Tools for Assessing and Managing Community Forests](#). U.S. Forest Service

[Quantifying the Benefits of Urban Forest Systems as a Component of the Green Infrastructure Stormwater Treatment Network](#). Kuehler et al. *Ecohydrology* (2017)

[The Role of Trees in Urban Stormwater Management](#). Berland et al. *Landscape and Urban Planning* 162:167–177 (2017)

Maintenance Requirements

Maintenance of street trees is performed by arborists, landscape professionals, homeowners or volunteers. For an extended tree pit, refer to the maintenance recommendations for bioretention. Supplemental irrigation might be required during initial tree establishment. Table 6-7 outlines long-term recommended maintenance activities that should be conducted for stormwater tree systems.

Alisha Goldstein



Trees are planted in groves connected by trenches in this parking lot at the Maplewood Mall, MN. Tree trenches extend 8 to 12 feet wide and 4 feet deep for a total of 1 mile in length. Angled curbs were designed to allow snowplows to roll smoothly over them.

Table 6-7. Recommended maintenance activities for stormwater tree systems

	Activity	Frequency	Additional advice
Debris	Inspect planter box structural integrity.	Annually	Any damaged components should be repaired or replaced.
	Remove sediment or trash that has accumulated.	Two to four times per year	
	Inspect underdrains for obstructions.	Annually	Backflush if obstructions are found.
Vegetation	Weed invasive and exotic species, preferably using nonchemical methods such as hand pulling and hoeing. For reforestation and afforestation project, remove ferns and grasses that would compete with tree seedlings.	Annually (preferably in spring)	If the survival rate of planted vegetation falls below 80% during this 3-year period, the cause of plant mortality should be investigated and corrected. Possible causes could be poor soils, soil compaction, or improper plant species selection (Hinman 2005).
	Check tree system after storm event to ensure stormwater is not ponding after 24 to 72 hours (check local codes).	As needed	If ponding does occur, either increase the infiltrative capacity of the soils or add an underdrain.
	Prune trees, including the removal of dead and diseased limbs and clear overgrowth to maintain street sign visibility, pedestrian vertical clearance, and line of sight on curved roads and intersections.	Annually	
	Protect tree from deer or other wildlife using tree guards or fencing.	As needed	
Soil	Turn or till soil, especially if compaction occurs.	As needed	If maintenance efforts are unsuccessful, the soil media and underdrain might need to be removed and replaced.
	Evaluate soil substrate for channel formation and proper root growth.	Annually	
	Remove and properly dispose of the previous mulch layer, or rototill into the soil surface and add new mulch layer.	Every 2 years (preferably in spring)	Do not exceed 3 inches in depth for mulch layers. Avoid blocking inflow entrance points with mounded mulch or raised plantings. Once a full groundcover is established, mulching might not be necessary.

6.6 Infiltration Trenches

Description

Infiltration trenches are excavated linear areas that are filled with layers of stone and sand wrapped in geotextile fabric. The trench is covered with stone, gabion, sand, or grassy surface with surface inlets. Stormwater is stored in the stone reservoir and slowly infiltrates through the bottom and sides of the trench, thereby reducing stormwater volume and peak discharge. As the water flows into the existing subsurface, pollutants and sediments are filtered out to improve water quality of the discharge. Underdrains can be included if native soil has lower permeability than desired. This system requires pretreatment to remove suspended solids.

Site Considerations

Infiltration trenches are ideal for linear transportation, linear parking lots and retrofit applications due to their relatively small foot print compared to the water storage capabilities. At minimum, they are generally 24 inches wide and 3 to 12 feet deep. Infiltration trenches are applicable only for small drainage areas, typically of less than 5 acres (RIDEM and CRMC 2010). They are typically implemented at the ground surface to intercept overland flows.

Infiltration trenches can also be installed below roadways or impervious areas with proper design. The design must prevent infiltration into the subbase of the pavement; therefore, it should slope slightly away from the subbase or be located at a depth below the subbase. Infiltration trenches can be used in a site's upland areas to reduce the amount of runoff downstream.

For More Information—Infiltration Trenches

[Infiltration Trench](#). City of San Diego (2011)

[Infiltration](#). Stormwater Manual (Chapter 3.8). District of Columbia (2013)

[Best Management Practice Fact Sheet 8: Infiltration Practices](#) (Publication 426-127). Virginia Cooperative Extension (2013)

Infiltration Trenches

Advantages:

- Reduce total volumetric runoff
- Provide water quality treatment for fine sediment, trace metals, nutrients, bacteria and organics
- Reduce downstream flooding and localized flooding
- Reduce the size and cost of downstream stormwater control facilities
- Provide groundwater recharge
- Avoid loss of parking spaces when designed underground
- Appropriate for small sites and where space is limited

Most suitable* for:

- Any length of roadway
- Parking lot
- Median

* Typically used on collector or arterial roads



Infiltration trench with grass cover.

Horsley Witten

Overcoming Site Challenges

Infiltration systems can be designed to overcome multiple site challenges (Table 6-8).

Table 6-8. Infiltration trenches: site constraints and design alternatives

Challenge	Design alternatives and recommendations
Sites that are not stable or have high sediment loads	Plan for pretreatment practices to avoid frequent and intensive maintenance.
Low permeability of native soils or compacted soils	Consider adding an underdrain that modifies the practice to be more of a soil filter or sand filter (i.e., converting to a different BMP).
Cold climates	Design the maximum effective depth for runoff below the frost line to allow infiltration to occur through the winter months.
Sites with high pollutant loads (i.e., potential hotspots) or contaminated soil	Avoid placing infiltrating systems due to concerns of groundwater contamination. Recommend practices include extensive pretreatment and/or impervious liner.
Proximity to water table	Maintain a recommended 2-foot separation to water table (3 feet preferred in some regions) and a minimum of 2 feet from the bottom of the infiltration trench to the bedrock (10 feet for fractured bedrock).
Proximity to drinking water wells	Trenches should be set back a minimum of 150 feet from public drinking water wells to limit groundwater contamination.
Proximity to building foundations	Trenches should be situated 100 feet upgradient or 10 feet downgradient to avoid potential seepage.

Infiltration Trench

Key Design Features

- Permeable filter fabric/material surrounds the stone on both sides of the trench
- An observation well allows for frequent inspection

Components: Infiltration Trench

An infiltration trench (Figure 6-8) typically consists of:

- An observation well
- Clean washed stone (typically 0.75 to 1.5-inch in diameter)
- A filter layer using either filter fabric, pea gravel (typically 3/8 inch) or sand
- Permeable filter fabric or sand filter on sides of trench

Optional design components include:

- Turf or grass cover
- Washed sand filter at bottom of practice for final filtration and even disbursement
- An elevated underdrain to promote internal storage and detention
- An impermeable liner (only in highly polluted areas)

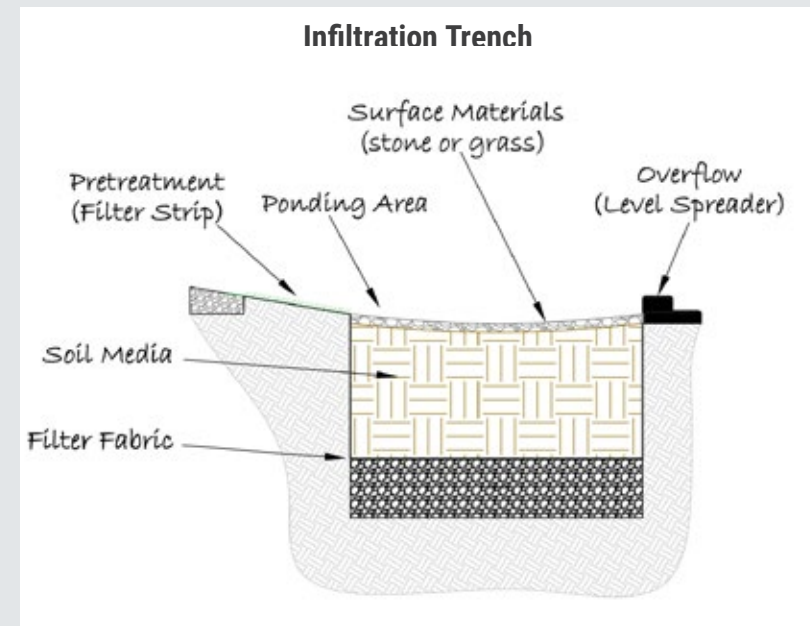

Image: Tetra Tech, Inc.

Figure 6-8. Stormwater infiltration trench schematic.

Design Considerations

Inlet Design

Runoff can enter an infiltration trench through sheet flow or piped inflow. To prevent clogging from sediment, pretreatment is required. When sheet flow is draining to the system, pretreatment might include a grass filter strip or gravel apron. If inflow is piped in, pretreatment might include a sediment forebay or a flow-through structure that collects sediment before conveying the water to the system. For areas with high pollutant loads, an oil and grit separator or similar device may be necessary. See Chapter 5 for descriptions of a number of pretreatment practices. Source control strategies, such as the elimination of excessive sanding/salting practices, should also be pursued. To ensure stormwater distribution in the stone trench, a perforated rigid pipe of at least 8-inch diameter can be connected to the inlet.

Slopes

Infiltration trenches are feasible if adjacent side slopes range from 2 to 15 percent. Slopes must be sufficiently steep to convey runoff to the practice, but must not cause erosion. To prevent underground infiltration trenches from draining into the subbase of the adjacent pavement, they should be sloped slightly away from or be located below the subbase.

Filter Layer

Filter fabric is used around the sides of the trench to define the system and prevent any potential contamination of runoff that is not completely treated. A filter layer should be incorporated into the top of the trench (6 to 12 inches below the surface) to prevent clogging from sediment carried in runoff but not removed by pretreatment and/or soil migration into the stone layer if turf or grass cover is included. Including filter fabric close to the surface minimizes maintenance and reconstruction needs if clogging occurs above the liner, as this portion can easily be removed and replaced. An alternative to filter fabric is the use of pea gravel or sand in the top 1 foot of the trench. The pea gravel improves sediment filtering and maximizes pollutant removal.

Observation Well

An observation well should be installed at the lower end of the infiltration trench to monitor how the system drains after large storms and to verify that the system is not clogged. The well should consist of a perforated PVC pipe with a 4- to 6-inch diameter that is constructed flush with the ground elevation and fitted with a lockable well cap. For larger trenches, which might require pumping to remove sediment, a 12- to 36-inch diameter PVC pipe is recommended to facilitate maintenance.

Backfill

The aggregate for the trench should consist of a clean aggregate with a maximum diameter of 3 inches and a minimum diameter of 1.5 inches. Void space should be in the range of 30 to 40 percent.

Vegetation

Infiltration trenches may be bare gravel or may be covered by turf or grass. Use a no-mow or low-maintenance seed mix for grass-covered trenches.



Infiltration trench (gravel) adjacent to a roadway.

Horsley Witten

Maintenance Requirements

These activities should be performed every 6 months and after every major storm (MADEP 2008). Suggested maintenance activities and frequencies are provided in Table 6-9. Additional maintenance is needed for pretreatment practices.

Performance

Infiltration trenches reduce stormwater volume, reduce peak discharge and improve water quality. By providing infiltration, these systems can promote groundwater recharge, contribute to baseflow for streams and help maintain the natural hydrologic balance that existed on the site before development. As the water filters through the system and into the existing subsurface, pollutants and sediments are removed and the water quality of the discharge improves. The primary pollutant removal mechanisms are settling, physical straining and filtration.



Minnesota Pollution Control Agency

Infiltration trench adjacent to a Minnesota roadway.

Table 6-9. Recommended maintenance activities for infiltration trenches

	Activity	Frequency	Additional advice
Debris	Inspect and remove sediment that has accumulated in the top foot of stone aggregate.	Two to four times per year	
	Inspect underdrains for obstructions.		If obstructions are found, backflush the obstructions.
Vegetation	Mow turf or grass. Remove invasive and exotic species, preferably using nonchemical methods such as hand pulling and hoeing.	Yearly (preferably in spring)	If at least 50% vegetation coverage is not established after 2 years, provide additional plantings.
	Check trench after storm events to ensure stormwater is not ponding after 72 hours.	After major storms	If ponding does occur, check for clogging and/or evaluate the infiltrative capacity of the soils.
Media	Check water levels, drawdown time and water quality using the observation well.	Two to four times a year	If the bottom of the trench is clogged, all of the stone aggregate and filter fabric must be removed. If clogging appears only at the surface, remove and replace the first layer of stone aggregate and filter fabric.

6.7 Subsurface Infiltration and Detention

Description

Subsurface infiltration and detention practices are subsurface systems that capture, temporarily store and slowly release stormwater to reduce runoff peak discharge. They provide stormwater quality treatment by decreasing sediment mobilization, transport and deposition, and they encourage biochemical processes in the underlying soils. Additionally, the water from these systems can be harvested and treated for other uses such as landscape irrigation or as a water source for fountains and ice skating rinks.

Design variations for subsurface infiltration and detention systems vary by materials, configuration and layouts, which are specified by manufacturers.

Subsurface infiltration systems consist of an infiltrative chamber system typically made of precast concrete or plastic that includes perforated pipes, galleys and chambers. The chambers can store large volumes of runoff which is allowed to slowly infiltrate into the ground. **Subsurface detention practices** temporarily store runoff before releasing it to a downstream practice or conveyance system. Although not designed for water quality benefits, these systems do provide some water quality improvement through sedimentation.

The typical elements of a subsurface system include infiltration pits, chambers, perforated pipes and galleys:

- **Infiltration pits.** This system consists of a precast barrel with uniform perforations. The barrel will sit on top of stone and will be backfilled with stone to promote infiltration. To create a sump for collection of sediment, the perforations should not extend to the bottom of the barrel. Pits may be placed in series to allow the overflow of one to be conveyed to the next pit in sequence.
- **Chambers.** Chambers consist of prefabricated modular or cylindrical cells surrounded by crushed, washed stone. If designed for infiltration, the chambers will have open bottoms or perforations. If designed solely for retention, the chambers are typically encased in an impermeable liner or are constructed of nonperforated pipes and are then discharged to an outlet control structure.

Subsurface Infiltration and Detention

Advantages:

- Capture and store large volumes of runoff
- Are suitable for highly urbanized area with limited surface space availability
- Reduce downstream flooding and localized flooding

- Provide groundwater recharge
- Quick installation process

Most suitable* for:

- Parking lot
- Sidewalks
- Roadways

* As long as maintenance access to these systems is available

- **Perforated Pipes.** A perforated pipe system acts like a leaching bed and consists of rows of perforated pipes that dose a leaching bed.
- **Galleys.** Galleys are concrete rectangular vaults or systems of interlocking modular units. If designed for infiltration, the rectangular vaults will have perforations.

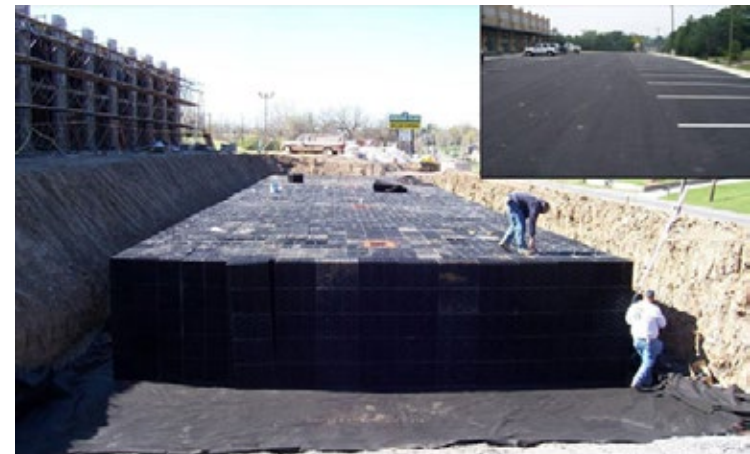

Horsley Witten

Subsurface chambers, during and after (top right) installation.

Design Considerations

Inlet Design

Stormwater typically enters subsurface practices through a catch basin or curb inlet (USEPA 2001). It can also enter the subsurface pit through porous pavement. Pretreatment is essential to prevent sediment or debris from migrating into and clogging the infiltration bed. Filter strips and modified catch basins (see Chapter 5) are good options for pretreating runoff entering subsurface infiltration and detention practices.

Materials

Many prefabricated subsurface infiltration or detention products are available. Systems can be constructed of concrete, steel or plastic (USEPA 2001). When determining the type of material to use for subsurface infiltration or detention structures, design engineers should consider the loading requirements and the available area. For example, steel and plastic require more fill than does concrete to maintain strength under compression. Large concrete structures provide more storage than pipes, but pipes are more versatile in their angling and arrangement (USEPA 2001). Enough stone should be included in the storage areas to prevent subsidence.

Overflows

Subsurface structures are typically designed to drain fully within 72 hours to provide adequate pollutant removal while also ensuring the system drains between rain events (MADEP 2008). Water standing for longer than 5 days can lead to potential mosquito breeding (Connecticut Department of Environmental Protection 2004). Detention systems must have outlet pipes sized to release stored runoff at the required rates.

Observation Well

An observation well, or manhole access for chamber systems, should be included to monitor how the system drains after large storms and to verify that the system is not clogged. The observation well should be placed at the invert of the stone bed and in the middle of the system.

Components: Subsurface Systems

A subsurface infiltration system (Figure 6-9) typically consists of:

- Inlet
- Pretreatment
- Perforated pipe

- Chamber
- Observation well
- Aggregate fill

Optional design component:

- Impermeable liner

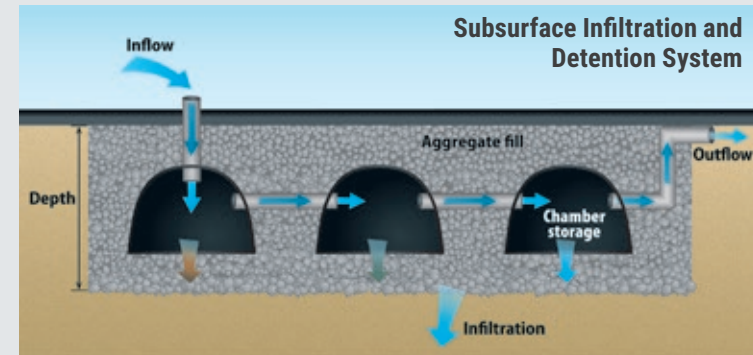

Figure 6-9. Subsurface infiltration and detention system schematic.

Vegetation

Trees or shrubs with long tap roots should not be planted within the immediate vicinity of subsurface structures.

Soils

The bottom of infiltrating practices should be level to promote evenly dispersed infiltration.

During construction, any area intended for infiltration should not be compacted. Erosion and sediment control techniques should be implemented during construction to prevent any sheet flow or windblown sediment from entering the infiltration area. Subsurface infiltration rates should typically be at least 0.5 inch per hour for infiltration practices.

Infiltration Trench

Key Design Features

- Provide an accessible maintenance entry point
- Include an observation well to allow for inspection
- Size the chamber according to the storm design volume

Maintenance Requirements

Because these systems are below ground, they are more difficult to maintain and clean than aboveground practices (USEPA 2001). These systems should therefore be located in areas where maintenance vehicles such as vacuum trucks can easily operate and excavate, if needed (RIDEM and CRMC 2010). Key maintenance practices needed are presented in Table 6-10.

Table 6-10. Recommended maintenance activities for subsurface infiltration and detention systems

	Activity	Frequency	Additional advice
Debris	Conduct observation well inspection of system to verify drainage times.	As needed	Monthly during the first year of infiltration to ensure functionality
	Remove sediment or trash that has accumulated to prevent clogging of pretreatment practices and inlets.	Two to four times per year	If excessive clogging builds up, the system should be excavated and replaced.

Performance

Subsurface infiltration and detention practices reduce both the volume of runoff and pollutant loads in runoff. Furthermore, the practices help recharge groundwater and reduce the size of downstream stormwater management practices. Subsurface infiltration provides water quality improvement through filtration into underlying soils.

These practices can be included as part of a series of stormwater management and treatment practices, called a treatment train. Detention practices can slow runoff volumes and slowly release them to downstream practices that will provide additional water quality improvement. Subsurface infiltration chambers can be used to provide additional storage volume and groundwater recharge as part of a treatment train (Connecticut Department of Environmental Protection 2004).



Perforated pipes in New York, NY.

Hazen and Sawyer

For More Information—Subsurface Detention

[Subsurface Detention](#). Stormwater Management Practice Guidance (Chapter 4.8). Philadelphia Water Department (2018)

[Infiltration Practices](#). Stormwater Design Specification No. 8. Virginia Department of Environmental Quality (2013)

6.8 Permeable Pavement

Description

Permeable pavements are paving systems that allow runoff to infiltrate through void space instead of becoming surface runoff. Water filters through void spaces within the paved surface into a stone reservoir and eventually infiltrates into the existing ground below. Where infiltration is not possible, permeable pavement systems can be designed with an underdrain that will convey treated runoff to another stormwater management practice or storm drain system.

Permeable pavement systems reduce runoff volumes and peak discharges by providing internal storage, and they improve water quality by filtering and infiltrating stormwater into the ground. Pretreatment is strongly recommended upstream of the practice to reduce sediment loads and to prevent debris from entering the system and clogging the drainage spaces between the pavers or the permeable surface. Some practitioners argue that “runon” from upland sources should be avoided or prohibited. Recommended pretreatment techniques are filter strips and swales (see Chapter 5).

Types of Permeable Pavement:

Porous Asphalt

Porous asphalt is a hot-mix asphalt with a reduced amount of sand or fines, which allows for increased interconnected pore space for water to drain through the pavement into a crushed stone reservoir and base. To maintain proper infiltration rates through the paving layer, the amount of asphalt binder in the mix must be minimized to prevent clogging of voids.

- **Permeable friction course (PFC)** is an application of porous asphalt over standard asphalt. PFC is also known as open-graded friction course on some highways. A PFC is a thin layer of porous asphalt, typically 1 to 2 inches thick, which is laid over standard asphalt. The stormwater travels through the voids in the permeable PFC asphalt until it reaches the impermeable asphalt boundary below and then flows towards the adjacent road perimeter. The principal purpose of this layer is to reduce hydroplaning by quickly removing precipitation from the pavement surface. The application of PFC leads to shorter stopping distances for cars, quicker surface drying periods, less splash and spray during precipitation (ASCE 2015). Additionally, PFC reduces the amount of pollutants discharged, reduces noise and improves safety for motorists.

Permeable Pavement

Advantages:

- Reduces runoff volume and peak discharge rates
- Increases groundwater recharge through infiltration
- Avoids loss of parking spaces
- Reduces occurrence of freezing puddles and black ice and requires less applied deicer

Most suitable for:

- Parking lots
- Parking lanes
- Driveways
- Sidewalks
- Walking paths
- Low-traffic roads
- Biking lanes
- Parkways
- Road shoulders on higher-volume roads



Permeable friction course on the shoulder of I-293 in New Hampshire.

Low Impact Development Center

Pervious Concrete

The design of pervious concrete differs from standard concrete because the fines have been removed from the concrete mix and different cementitious materials and chemicals have been added, such as fly ash and air-entraining agents. When installed, pervious concrete looks similar to conventional concrete except it typically has a rougher surface and allows for infiltration into the ground. Pervious concrete is also available in precast concrete panels that are placed together on site.

Pavers

Pavers are pre-cast paving units that are arranged to leave void spaces between the pavers. These voids are filled with sand, fine gravel, or are planted with turf or grass to allow for water to infiltrate through the pavers into the underlying stone reservoir. Many types of pavers are available, including the following three:

- **Permeable interlocking concrete pavement (PICP).** PICP is comprised of a layer of durable concrete pavers separated by joints that are filled with small stones. The blocks are impervious, but the joints permit infiltration to the stone reservoir. The joints, or interlocking shapes, can vary from simple notches to built-in concrete joint spacers. PICPs are highly attractive, durable, easily repaired, require low maintenance and can withstand heavy vehicle loads
- **Concrete grid pavement (CGP).** CGP is an extensive concrete grid that uses large spaces filled with stone aggregate or with sod or turfgrass. The reinforced concrete structure provides stability for bearing the weight of vehicles; the stone or sod-filled spaces provide permeability. Unlike PICP, concrete grid pavements are generally not designed with an open-graded, crushed stone base for water storage and thus have lower infiltrative rates. Moreover, grids are for intermittently trafficked areas such as overflow parking areas and emergency fire lanes.
- **Grass pavers (turf blocks).** Grass pavers are a type of open-cell unit paver in which the cells are filled with soil and planted with turf. The pavers can be made of concrete or synthetic material. The pavers serve to distribute the weight of traffic evenly and prevent compaction of the underlying soil.

Porous Recycled Surface Products

These products are generally more attractive than porous asphalt and are suitable for pedestrian and light vehicular traffic loads. They are typically highly reflective, colorful porous paving systems that provide greater design flexibility. Constructed of a porous, hard surface paving made from recycled glass, waste granite, rubber, aggregates and/or other recycled material, they are often bound together with a proprietary pigmented binder. Similar to porous pavement, this design alternative allows runoff to drain through the paved surface into a crushed stone reservoir.



Alisha Goldstein

Permeable paver installation in parking lanes in Louisville, KY.



USEPA

Permeable interlocking concrete pavement, Chicago, IL.

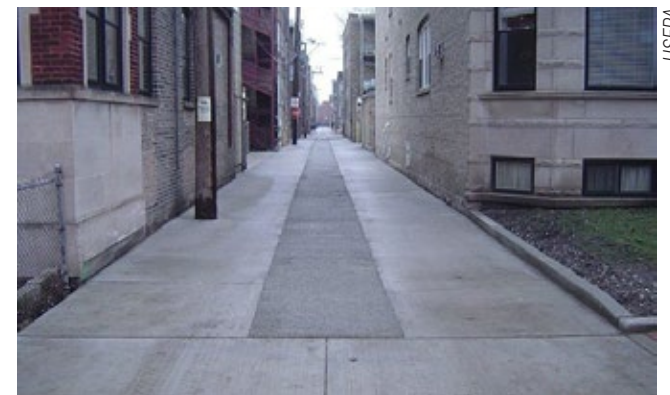

USEPA

Pervious concrete trench in the center of an alley, Chicago, IL.

Site Considerations

Generally, permeable pavement is recommended for low-volume and low-speed applications with limited turning traffic. The use of permeable paving can potentially reduce the size and extent of downstream stormwater collection, conveyance and detention. Because permeable pavement systems provide their own stormwater management, they can be used to maximize drivable surface area. Permeable pavements can be designed for only a partial area of the design site and installed in combination with impermeable pavement such as in the parking lane of a street or in the parking stalls of a parking lot. It is not recommended to drain impermeable surfaces onto the permeable areas due to clogging concerns.

Permeable pavements are generally not appropriate for high-traffic or high-speed areas because they have lower load-bearing capacity than conventional pavement; however, interlocking pavers have been used in high-load installations in cargo ports and airports. Although pavers tend to be more costly to install than other paving systems, they are easier to repair because small sections can be removed and replaced (San Mateo County 2020). In contrast, damaged permeable pavement is difficult to repair because it is made in large batches. When selecting the type of material, consider the traffic volume, type of use and expected maintenance frequency.

Care should be taken to not place permeable pavements adjacent to land uses or areas that could contribute high sediment or organic material loadings (e.g., heavily wooded or landscaped areas where leave, mulch or soil can wash off and clog the pavement).

Overcoming Site Challenges

Permeable pavement systems can be designed to overcome site challenges such as a high groundwater table, high-traffic areas, or steep slopes (Table 6-11).

Kary Phillips, Tetra Tech, Inc.

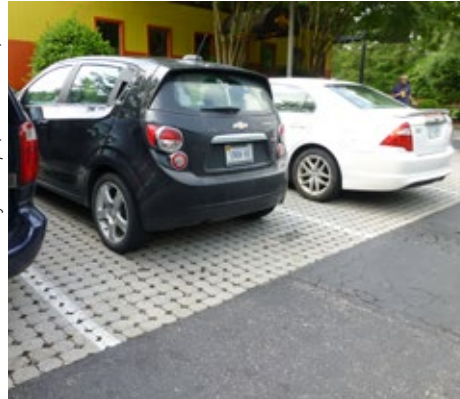

Permeable pavement in parking stalls in Williamsburg, VA.

Abby Hall, USEPA



Concrete grid pavers in Emeryville, CA.

Table 6-11. Permeable pavement: site constraints and design alternatives

Challenge	Design alternatives and recommendations
Potential groundwater contamination or proximity to water table or bedrock	Line the subsurface reservoir with an impermeable liner. For areas where there is a potential for hazardous spills (e.g., gas stations, loading docks), permeable pavement is not recommended
Cold climate	Avoid applying sand, which can clog the surface of the material. Do not use areas with permeable pavement as plowed snow storage areas.
Conflict with underground utilities	Offset infiltration trenches away from utility lines.
High-traffic or high-speed areas	Permeable pavements are not recommended because they have lower load-bearing capacity than conventional pavement.
Steep slopes	Construct subgrade check dams, baffles, or terraces to provide a level area for storage area.
Low permeability of native soils or compacted soils	Replace or amend soils to improve permeability.
Low structural capacity of clay soils	Increase the subbase depth and/or add geogrids to provide additional support.

Components: Permeable Pavement

Permeable pavement components (Figures 6-10 and 6-11) typically consist of:

- **Pavers or pervious pavement.** 4 to 6 inches of permeable material (e.g., asphalt or concrete) with 10 to 25 percent void space. Paver thickness is determined by loading rates.
- **Choker course for porous asphalt.** 1 to 2 inches of small-sized, open-graded aggregate below the paver/pavement layer. Provide a level bottom to promote even infiltration through the practice.
- **Open-graded base reservoir.** 3 to 4 inches of crushed stones (typically $\frac{3}{4}$ – $\frac{3}{16}$ inch in size) with a high void content to maximize the storage of infiltrated water and to create a capillary barrier to winter freeze/thaw.
- **Open-graded subbase reservoir.** Thickness depends on water storage requirement and traffic loads. Uniformly

graded, clean and washed coarse aggregate ($\frac{3}{4}$ – $2\frac{1}{2}$ inch in size with 40 percent void space) are used. Might not be required in pedestrian or residential driveway applications.

- **Subgrade.** The infiltrative capacity of the aggregate determines how much water exfiltrates from the subgrade to the surrounding soils. An uncompacted subgrade is preferable.

Optional design components include:

- **Underdrain**
- **Impermeable liner** for conditions where infiltration is undesirable.
- **Geotextile or other filter material** such as pea gravel placed between the subbase and the subgrade to prevent the migration of soil.
- **Observation well** to enable visual monitoring and inspection of the system for maintenance.

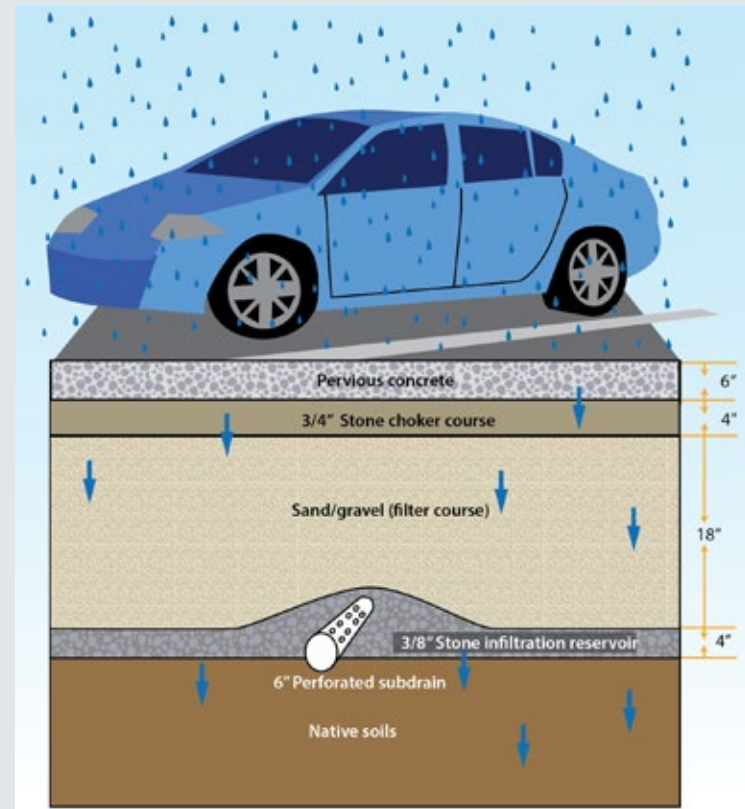

Image: University of New Hampshire Stormwater Center

Figure 6-10. Typical pervious concrete pavement cross-section.

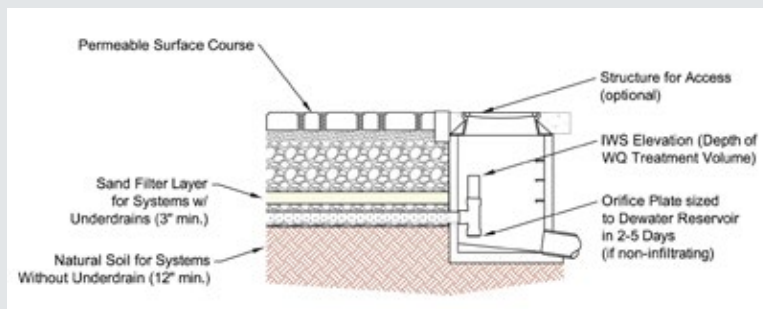

Image: Tetra Tech

Figure 6-11. Permeable interlocking concrete pavement cross-section.

Permeable Pavement

Key Design Features

- Level storage bed bottoms
- The surface permeability should be greater than 20 inches per hour.
- Pretreatment highly recommended to remove sediment-laden runoff.
- Load-bearing capacity of subgrade determines design depth.
- Infiltrative capacities of permeable pavement and aggregate in subgrade layers.

Design Considerations

Materials

Permeable and conventional pavements require similar materials and construction techniques with a few exceptions. Permeable pavement requires greater depth of the aggregate subbase to provide additional stormwater volume storage. A geotextile material might be required in areas of unstable soils or when the groundwater table is high (University of New Hampshire Stormwater Center 2012; MADEP 2008; RIDEM and CRMC 2010). Permeable pavement should not be installed during rain or over frozen base material. To maximize infiltration, avoid compacting subgrade soil during installation. If compaction is needed to support vehicle loads, compaction density and subsequent soil infiltration should be assessed in a test pit(s) on the site to determine an acceptable soil density and its contribution to soil strength and infiltration.

Sizing

The at-grade contributing drainage area into permeable pavement should generally not exceed twice the surface area of the permeable pavement (runoff from permeable areas is not recommended due to potential for clogging of permeable pavement). This guideline helps reduce the rate of surface sedimentation. The 2:1 ratio can be increased to no greater than 5:1 if at least one of these conditions exists:

- Permeable pavement is receiving runoff from roofs as it tends to be very low in sediment.
- Runoff from adjacent impervious surfaces remains unburdened with sediment due to effective pretreatment before entering the permeable pavement.

Slopes

The permeable pavement subbase should be installed on level ground. For slopes greater than 3 to 5 percent, check dams, baffles or terraces can be built as part of the subgrade to provide a level area for storage area. Otherwise, there will be little storage capacity. If excavations are necessary

to provide adequate storage, utilities might need to be relocated to maintain adequate clearance.

Performance

Permeable pavement systems reduce stormwater peak discharge and runoff volume by storing runoff within the subbase layers as it slowly infiltrates. A larger reservoir layer allows more runoff volume to be stored within the practice. As the runoff filters through the varying layers, the water quality of the runoff is also improved.

PFCs, a use of permeable asphalt, achieve very little runoff volume or peak flow reduction because they are not tied to any underground storage (NCHRP 2009). However, they have been found to achieve significant removal of sediment-bound pollutants, with effluent total suspended solids concentrations in the range of 10 milligrams per liter (Eck et al. 2012). In addition to pollutant removal, PFCs act as a level spreader, dissipating stormwater velocity and limiting erosion.



Alisha Goldstein

Permeable pavers used in the parking lane of a roadway in Ann Arbor, MI.

Maintenance Requirements

The primary goal of permeable pavement maintenance is to keep the surface clean and free of debris to maintain efficiency. If drainage voids or openings in the surface are not regularly cleaned and vacuumed, the pavement surface and/or underlying infiltration bed can become clogged with fine sediments. Signs should be posted indicating that sanding is not required and that construction and hazardous materials vehicles should not drive on permeable pavement. Key maintenance needs are outlined in Table 6-12; these activities might need to occur more often depending on the frequency and size of storm events.

For More Information—Permeable Pavement

[Soak Up the Rain: Permeable Pavement](#). USEPA (2015)

[Permeable Pavement Systems](#). Stormwater Manual (Chapter 3.5).
District of Columbia (2013)

Federal Highway Administration Tech Briefs:

[Porous Asphalt Pavements with Stone Reservoirs](#). (2015)

[Permeable Interlocking Concrete Pavement](#). (2015)

[Permeable Concrete Pavements](#). (2016)

Table 6-12. Recommended maintenance activities for permeable pavement

	Activity	Frequency	Additional advice
Debris	Inspect for proper drainage and potential deterioration.	4 to 6 months after installation and then annually	
	Remove sediment or trash that has accumulated to prevent clogging from pretreatment practices and inlets.	Two to four times per year	
	Perform vacuum sweeping.	Twice per year	
	Conduct power hose washing.	Twice per year	Recommended after sweeping and vacuuming. Inspect the aggregate and refill with clean stone or gravel if necessary.
	Inspect adjacent areas, which should be kept well-landscaped to prevent soil washout and to minimize the risk of sediment, mulch, grass clippings, etc., from inadvertently clogging the permeable pavement.	Annually	Design pretreatment elements between landscaped areas and permeable pavement sections to collect sediment and other organics.
	Reseed bare spots on grass pavers.	As needed	
	Inspect surface for cracks or settling; replace any cracked or broken sections.	Annually	
Cold Weather	Avoid the use of salt and sand for snow treatment to maintain permeability and prevent clogging.		
	Carefully perform snow plowing.		Set blade slightly higher than usual or attach rollers to the bottoms of snowplows to prevent catching the edges of pavers.
	Minimize the accumulation of snow piles on the permeable pavement to prevent the settling of sediments and pollutants on the surface, which could lead to clogging.		

7

References

- Arnold, C.L., Jr. and C.J. Gibbons. 1996. Impervious Surface Coverage: The Emergence of a Key Environmental Indicator. *Journal of the American Planning Association* 62(2):243–258.
- ASCE (American Society of Civil Engineers). 2015. *Permeable Pavements*. Ed. B. Eisenberg; K. Collins Lindow, P.E.; and D.R. Smith. American Society of Civil Engineers, Reston, VA.
- Barrett, M.E. 2004. Performance and design of vegetated BMPs in the highway environment. In *Proceedings of the 2004 World Water and Environmental Resources Congress: Critical Transitions in Water and Environmental Resources Management*, Salt Lake City, Utah, June 27–July 4, 2004, pp. 777–786.
- Bergstrom, D., K. Rose, J. Olinger, and K. Holley. 2013. *The Sustainable Communities Initiative: The Community Engagement Guide for Sustainable Communities*. PolicyLink and Kirwan Institute. <http://www.policylink.org/find-resources/library/community-engagement-guide-for-sustainable-communities>.
- BES (Bureau of Environmental Services). 2006. Vegetated Swales. City of Portland, Bureau of Environmental Services, Portland, OR. <https://www.portlandoregon.gov/bes/article/127473>.
- BES (Bureau of Environmental Services). 2008. *Erosion and Sediment Control Manual*. City of Portland, Bureau of Environmental Services, Portland, OR. <https://www.portlandoregon.gov/bes/article/474129>.
- Burden, D. 2006. *22 Benefits of Urban Street Trees*. Glatting Jackson and Walkable Communities, Inc. https://www.walkable.org/download/22_benefits.pdf.
- CEI and NHDES (Comprehensive Environmental, Inc. and New Hampshire Department of Environmental Services). 2008. *New Hampshire Stormwater Manual. Volume 2, Chapter 4-4*. <https://www.des.nh.gov/sites/g/files/ehbemt341/files/documents/2020-01/vol2-ch4-sct4.pdf>.
- Clary, J., J. Jones, M. Leisenring, P. Hobson, and E. Strecker. 2017. *International Stormwater BMP Database: 2016 Summary Statistics*. Prepared for Water Environment & Reuse Foundation by Wright Water Engineers, Inc., and Geosyntec Consultants.
- CNT (Center for Neighborhood Technology) and American Rivers. 2010. *The Value of Green Infrastructure: A Guide to Recognizing Its Economic, Environmental and Social Benefits*. Center for Neighborhood Technology, Chicago, IL; American Rivers, Washington, DC. <http://www.cnt.org/publications/green-infrastructure>.
- Colwell, S.R., R.R. Horner, and D.B. Booth. 2000. *Characterization of Performance Predictors and Evaluation of Mowing Practices in Biofiltration Swales*. Report to King County Land and Water Resources Division and others by Center for Urban Water Resources Management, Department of Civil and Environmental Engineering, University of Washington, Seattle, WA.
- CWH (Council for Watershed Health). 2010. *Water Augmentation Study: Research, Strategy, and Implementation*. Council for Watershed Health, Los Angeles, CA. <https://www.usbr.gov/lc/social/reports/LASGwtraugmentation/report.pdf>.

- Connecticut Department of Environmental Protection. 2004. *Connecticut Stormwater Quality Manual*. 2004. Connecticut Department of Environmental Protection, Department of Energy and Environmental Protection, Hartford, CT. <http://www.ct.gov/deep/cwp/view.asp?a=2721&q=325704>.
- CWP (Center for Watershed Protection). 2007. *National Pollutant Removal Performance Database, Version 3.0*. Center for Watershed Protection, Ellicott City, MD.
- CWP and CSN (Center for Watershed Protection and Chesapeake Stormwater Network). 2008. Technical Support for the Baywide Runoff Reduction Method. Baltimore, MD. www.chesapeakestormwater.net.
- Davis, A.P., Hunt, W.F., Traver, R.G., and Clar, M. 2009. Bioretention technology: overview of current practice and future needs. *Journal of Environmental Engineering* 135:109–117.
- DC OP (District of Columbia Office of Planning). 2011. *New York Avenue Green Infrastructure Assessment*. District of Columbia Office of Planning, Washington, DC. http://planning.dc.gov/sites/default/files/dc/sites/op/publication/attachments/NY_Ave_GIA_5_23_part1.pdf.
- Denman, L., P.B. May, and P.F. Breen. 2006. An investigation of the potential to use street trees and their root zone soils to remove nitrogen from urban stormwater. *Australasian Journal of Water Resources* 10(3).
- Donovan, G.H. and D.T. Butry. 2010. Trees in the City: Valuing Street Trees in Portland, Oregon. *Landscape and Urban Planning* 94:77–83.
- Driscoll, E., P. Shelley, and E. Strecker. 1990. *Pollutant Loadings and Impacts from Highway Stormwater Runoff Volume I: Design Procedure*. Federal Highway Administration, Washington, DC. <https://www.usgs.gov/media/files/fhwa-rd-88-006>.
- Eck, B.J., R.J. Winston, W.F. Hunt, M.E. Barrett. 2012. Water Quality of Drainage from Permeable Friction Course. *Journal of Environmental Engineering* 138(2).
- FHWA (Federal Highway Administration). 1984. *Sources and Mitigation of Highway Runoff Pollutants*. Federal Highway Administration, Washington, DC.
- FHWA (Federal Highway Administration). 2016. *Highway Statistics 2016*. U.S. Department of Transportation, Federal Highway Administration, Washington, DC. <https://www.fhwa.dot.gov/policyinformation/statistics.cfm>.
- Fitzpatrick, K., P. Carlson, M. Brewer, and M. Woolridge. 2000. Design Factors That Affect Driver Speed on Suburban Streets. *Transportation Research Record* 1751:18–25.
- Hinman, C. 2005. *Low Impact Development Technical Guidance Manual for Puget Sound*. Puget Sound Action Team. Washington State University, Pierce County Extension, Tacoma, WA. http://www.psp.wa.gov/downloads/LID/LID_manual2005.pdf.
- Holtan, M.T., S.L. Dieterlen, and W.C. Sullivan. 2014. Social Life Under Cover: Tree Canopy and Social Capital in Baltimore, Maryland. *Environment and Behavior* 1(24).
- Kaplan, S. 1995. The restorative benefits of nature: Toward an integrative framework. *Journal of Environmental Psychology* 15(3):169–182.
- LIDC (Low Impact Development Center). 2005. *Tree Box Filters: Low Impact Development for Big Box Retailers*. Prepared for U.S. Environmental Protection Agency, Office of Water, Washington, DC.
- MADEP (Massachusetts Department of Environmental Protection). 2008. *Massachusetts Stormwater Handbook. Volume 2, Chapter 2*. Massachusetts Department of Environmental Protection, Boston, MA. <http://www.mass.gov/eea/agencies/massdep/water/regulations/massachusetts-stormwater-handbook.html>.

- MHD (Massachusetts Highway Department). 2006. *Massachusetts Highway Project Development and Design Guidebook: Chapter 13, Landscape and Aesthetics*. Massachusetts Highway Department, Boston, MA.
- MPCA (Minnesota Pollution Control Agency). 2013. *Minnesota Stormwater Manual*. Minnesota Pollution Control Agency, St. Paul, MN. https://stormwater.pca.state.mn.us/index.php/Main_Page.
- MWCOG (Metropolitan Washington Council of Governments). 2007. *Plan To Improve Air Quality In The Washington, DC-MD-VA Region. State Implementation Plan (SIP) for 8-Hour Ozone Standard*. Prepared for District of Columbia Department of Environment, Maryland Department of the Environment and Virginia Department of Environmental Quality. www.mwco.org/environment/air/SIP/default.asp.
- NCHRP (National Cooperative Highway Research Program). 2009. *NCHRP Report 640 Construction and Maintenance Practices for Permeable Friction Courses*. National Academies of Sciences, Engineering, and Medicine: Transportation Research Board, National Cooperative Highway Research Program, Washington, DC. http://onlinepubs.trb.org/onlinepubs/nchrp/nchrp_rpt_640.pdf.
- NCSC (National Complete Streets Coalition). n.d. *Implementing Complete Streets 4: Sustainable Complete Streets*. National Complete Streets Coalition, Washington, DC. <http://old.smartgrowthamerica.org/documents/cs/factsheets/cs-greenstreets.pdf>.
- NHDES (New Hampshire Department of Environmental Services). 2008. Pretreatment Practices. Chapter 4-4 in *New Hampshire Stormwater Manual, Volume 2: Post-Construction Best Management Practices Selection and Design*. New Hampshire Department of Environmental Services, Concord, NH. <https://www.des.nh.gov/sites/g/files/ehbemt341/files/documents/2020-01/vol2-ch4-sct4.pdf>.
- NRC (National Research Council). 2008. *Urban Stormwater Management in the United States*. The National Academies Press, Washington, DC. http://www.epa.gov/npdes/pubs/nrc_stormwaterreport.pdf.
- NRDC (Natural Resource Defense Council). 2013. *The Green Edge: How Commercial Property Investment in Green Infrastructure Creates Value*. Natural Resource Defense Council, New York, NY. <http://www.nrdc.org/water/commercial-value-green-infrastructure.asp>.
- Pomerantz, M.H. Akbari, S-C. Chang, R. Levinson, and B. Pon. 2003. *Examples of Cooler Reflective Streets for Urban Heat-Island Mitigation: Portland Cement Concrete and Chip Seals*. No. 49283. Lawrence Berkeley National Laboratory, Berkeley, CA. <http://repositories.cdlib.org/lbnl/LBNL-49283>.
- Prince George's County, Maryland. 2010. *Environmental Technical Manual*. The Maryland-National Capital Park and Planning Commission and Prince George's County Planning Department. <http://www.pgplanning.org/DocumentCenter/View/1072>.
- Qin, H., Z. Li, and G. Fu. 2013. The effects of low impact development on urban flooding under different rainfall characteristics. *Environmental Management* 129:577–585. <http://www.sciencedirect.com/science/article/pii/S0301479713005495>.
- RIDEM and CRMC (Rhode Island Department of Environmental Management and Coastal Resources Management Council). 2010. *Rhode Island Stormwater Design and Installation Standards Manual*. Rhode Island Department of Environmental Management, Providence, RI; Coastal Resources Management Council; Wakefield, RI. <http://www.dem.ri.gov/pubs/regs/regs/water/swmanual.pdf>.
- RTI and Geosyntec. 2014. *Low Impact Development Stormwater Control Cost Estimation Analysis*. Prepared for U.S. Environmental Protection Agency, Office of Research and Development, by RTI International, Research Triangle Park, NC, and Geosyntec Consultants, Lafayette, CO.

- San Mateo County. 2020. *San Mateo Green Infrastructure Design Guide*. San Mateo County, CA. <https://www.flowstobay.org/data-resources/resources/green-infrastructure-design-guide/>.
- Santamouris, M. ed. 2001. *Energy and Climate in the Urban Built Environment*. 1st ed. Routledge Publishing, Abingdon, United Kingdom.
- Tilley, J.S., and E.T. Slonecker. 2006. *Quantifying the Components of Impervious Surfaces*. Open-File Report 2006-1008. U.S. Geological Survey, Reston, VA.
- TFA (Transportation for America). 2019. *Dangerous by Design: Solving the Epidemic of Preventable Pedestrian Deaths*. Transportation for America, Washington, DC. <https://smartgrowthamerica.org/resources/dangerous-by-design-2019/>.
- University of New Hampshire Stormwater Center. 2012. *2012 Biennial Report*. University of New Hampshire, Durham, NH. <https://www.unh.edu/unhsc/sites/unh.edu.unhsc/files/docs/UNHSC.2012Report.10.10.12.pdf>
- USDOT (U.S. Department of Transportation). 2013. *Highway Functional Classification Concepts, Criteria and Procedures*. FHWA-PL-13-026. U.S. Department of Transportation, Federal Highway Administration, Washington, DC.
- USFS (U.S. Forest Service). 2014. i-Tree: Tools for Assessing and Managing Community Forests. U.S. Department of Agriculture Forest Service, Washington, DC. Accessed March 2014. <http://www.itreetools.org/index.php>.
- USEPA (U.S. Environmental Protection Agency). 2001. *Storm Water Technology Fact Sheet: On-Site Underground Retention/Detention*. EPA 832-F-01-005. U.S. Environmental Protection Agency, Washington, DC.
- USEPA (U.S. Environmental Protection Agency). 2008. *Reducing Urban Heat Islands: Compendium of Strategies*. U.S. Environmental Protection Agency, Washington, DC. <https://www.epa.gov/heat-islands/heat-island-compendium>.
- USEPA (U.S. Environmental Protection Agency). 2013. *Case Studies Analyzing the Economic Benefits of Low Impact Development and Green Infrastructure Programs*. U.S. Environmental Protection Agency, Washington, DC. https://www.epa.gov/sites/production/files/2015-10/documents/lid-gi-programs_report_8-6-13_combined.pdf.
- USEPA (U.S. Environmental Protection Agency). 2014. *The Economic Benefits of Green Infrastructure: A Case Study of Lancaster, PA*. U.S. Environmental Protection Agency, Office of Research and Development, Washington, DC. <https://www.epa.gov/green-infrastructure/economic-benefits-green-infrastructure-case-study-lancaster-pa>.
- USEPA (U.S. Environmental Protection Agency). 2016. *Estimating Monetized Benefits of Groundwater Recharge from Stormwater Retention Practices*. U.S. Environmental Protection Agency, Office of Water, Nonpoint Source Control Branch, Washington, DC. https://www.epa.gov/sites/production/files/2016-08/documents/gw_recharge_benefits_final_april_2016-508.pdf.
- Vingarzan, R. and B. Taylor. 2003. Trend Analysis of Ground Level Ozone in the Greater Vancouver/Fraser Valley Area of British Columbia. *Atmospheric Environment* 37(16):2159–2171.
- WSDOT (Washington State Department of Transportation). 2016. M31-16.04. WSDOT Design Office, Highway Runoff Unit, Olympia, WA. <https://www.wsdot.wa.gov/publications/manuals/fulltext/M31-16/highwayrunoff.pdf>
- Young, G. Kenneth, Stuart Stein, Pamela Cole, Traci Kammer, Frank Graziano, Fred Bank. 1996. *Evaluation and Management of Highway Runoff Water Quality*. U.S. Department of Transportation, Office of Environment and Planning, Federal Highway Administration, Washington, DC.

Appendix

J

AUTHORITY BMP DESIGN MANUAL

Alternative Compliance Program

Appendix J Alternative Compliance Program

The MS4 Permit allows the Authority the discretion to develop an alternative compliance program for PDPs. Participation in this program would allow a PDP to implement flow-through BMPs onsite without completely fulfilling the pollutant control requirement in Chapter 5 of the Manual (retention and/or biofiltration to mitigate the full DCV). The portion of the DCV not retained onsite would then be mitigated via an offsite project.

J.1 Prerequisites to Program Development

Prior to the development of an alternative compliance program, the Watershed Management Area Analysis (WMAA) must be incorporated into the San Diego Bay WQIP, and the RWQCB must accept Water Quality Equivalency guidelines that provide a currency basis for demonstrating water quality benefit for offsite projects. These requirements are discussed below.

J.1.1 Watershed Management Area Analysis

A WMAA, as described in MS4 Permit Provision B.3.b(4)(a), was performed by the Copermittees and included in the San Diego Bay WQIP. As part of the WMAA, some Copermittees identified and compiled lists of candidate projects that could potentially be used as alternative compliance options for PDPs. These lists include opportunities such as:

- 1) Stream or riparian area rehabilitation;
- 2) Retrofitting existing infrastructure to incorporate storm water retention or treatment;
- 3) Regional BMPs;
- 4) Groundwater recharge projects;
- 5) Water supply augmentation projects; and
- 6) Land purchases to preserve floodplain functions.

At this time, the Authority has not developed a candidate project list for opportunities within the Authority's jurisdiction. A list may be developed as opportunities are identified. In this case, the list will be included in the subsequent WQIP update. A PDP may independently propose a project for alternative compliance that is not on the candidate project list, as discussed in Section J.2.2.

J.1.2 Water Quality Equivalency

A Water Quality Equivalency Guidance Document was developed by the Copermittees and accepted by the RWQCB on July 9, 2020. The Water Quality Equivalency (WQE) Guidance Document for Region 9¹² (WQE Guidance Document) provides the standards and guidance for PDPs to demonstrate that an alternative compliance project will achieve a “greater overall water quality benefit.” PDPs must utilize this document to show that the volume of storm water treated through an offsite project is equal to or greater than the deficit of treated storm water from the PDP. The steps to perform these water quality equivalency calculations include:

- 1) Quantifying the PDP storm water pollutant control impacts;
- 2) Determining the alternative compliance project storm water pollutant control benefits; and
- 3) Determining the storm water pollutant control credits (i.e., subtracting the PDP impacts from the alternative compliance project benefits and ensuring that the result is greater than or equal to zero).

The WQE Guidance Document is located on the Project Clean Water website (www.projectcleanwater.org) and provides detailed instructions for calculating water quality equivalency for ACPs.

¹² WQE Guidance Document Region 9 May 2018

J.2 Alternative Compliance Options

The general framework of the program is described below. Section J.2.1 describes the requirements that apply to all alternative compliance projects. Section J.2.2 describes the process for applicant-initiated alternative compliance projects. Section J.2.3 describes an in-lieu fee and/or credit program for alternative compliance.

J.2.1 General Requirements

The alternative compliance program is available to a PDP only if the PDP applicant enters into a voluntary agreement with the Authority authorizing this arrangement. In addition to the voluntary agreement, relief from implementing structural BMPs onsite may be authorized by the Authority under the following conditions:

- 1) The Authority must determine that implementation of the candidate project will have a greater overall water quality benefit for the WMA than fully complying with the onsite storm water pollutant control requirements;
- 2) If a PDP applicant chooses to fully or partially fund a candidate project as described in Section J.2.2, then the in-lieu fee structure described in Provision E.3.c.(3)(d) must be followed;
- 3) If the PDP applicant chooses to fully or partially fund a candidate project, then the Authority will ensure that the funds to be obtained from the PDP applicant are sufficient to mitigate for impacts caused by not fully implementing structural BMPs onsite, pursuant to the performance requirements described in Section 5 of the Manual;
- 4) If the PDP applicant chooses to implement a candidate project, then the Authority will ensure that pollutant control management within the candidate project is sufficient to mitigate for impacts caused by not implementing structural BMPs fully onsite, pursuant to the performance requirements described in Section 5 of the Manual;
- 5) The voluntary agreement to fund, partially fund, or implement a candidate project must include reliable sources of funding for operation and maintenance of the candidate project;
- 6) Design of the candidate project must be conducted under an appropriately qualified engineer, geologist, architect, landscape architect, or other professional, licenses where applicable, and competent and proficient in the fields pertinent to the candidate project design;
- 7) The candidate project must be constructed as soon as possible, but no later than 4 years after the certificate of occupancy is granted for the first PDP that contributed funds toward the construction of the candidate project, unless a longer period of time is authorized by the RWQCB Executive Officer; and
- 8) If the candidate project is constructed after the PDP is constructed, the Authority will require temporal mitigation for pollutant loads and altered flows that are discharged from the PDP.

J.2.2 Phase I

Under Phase I of the alternative compliance program, the Authority may allow a PDP applicant to propose and fund, contribute funds to, or implement an alternative compliance project not identified by the WMAA included in the San Diego Bay WQIP. The PDP applicant must demonstrate to the satisfaction of the P&EAD and ADC that implementation of the alternative compliance project will have a greater overall water quality benefit than fully complying with the performance requirements outlined in Section 5 of the Manual. This option is available to PDP applicants as of February 16, 2016.

J.2.3 Phase II

Under Phase II of the alternative compliance program, a PDP may be allowed to participate in alternative compliance through either an in-lieu fee or through compliance with a water quality credit system. An in-lieu fee alternative compliance option is not available at this time, but a water quality credit system has been developed by the Authority, accepted by the RWQCB, and is an available alternative compliance option. This Manual will be updated as the option for in-lieu fee or the credit system become available.

In-Lieu Fee Option: The Authority may allow a PDP applicant to fund, or partially fund a candidate project or an alternative compliance project through paying an in-lieu fee. The in-lieu fee structure may be developed by the Authority individually or with other Copermittees and/or entities, and will provide a framework for designing, developing, constructing, operating and maintaining offsite alternative compliance projects. The in-lieu fee must be transferred to the Authority (for capital projects) or an escrow account (for tenant projects) prior to the construction of the PDP.

Water Quality Credit System Option. With approved WQE calculations, the Authority prepared a WQE Credit Trading Framework (Framework), which provides a framework for implementing water quality credit trading at the San Diego International Airport (SAN). The Framework was approved by the RWQCB on July 9, 2020. Water quality credits calculated per WQE Guidance Document can be used to partially or wholly satisfy pollutant control requirements for a proposed PDP through an ACP that achieves “greater overall water quality benefit.” This Framework relies on the WQE Guidance Document as a basis for outlining the methods that the Authority can use to bank, track, and trade water quality credits for development projects implemented by the Authority within the Jurisdiction of the Authority. Guidance on the policies developed specifically for SAN is provided in the Framework document and should be utilized when an ACP is approved by the Authority.

This Framework currently only applies to development projects at SAN that are owned and constructed by the Authority, that is, the Authority will be both the PDP owner and ACP owner, as well as the sole party to bank, track, and trade water quality credits. As such, all the projects managed by this Framework are Applicant-Implemented ACPs owned by the Authority. Per the WQE Guidance Document, an “Applicant-Implemented ACP” does not require a credit system to track, and trade associated impacts and benefits, unless the program generates excess credits. These excess credits may be banked for use by a future project implemented by the Authority.

Appendix J: Alternative Compliance Program

This Framework currently excludes Independent ACPs constructed by airport tenants or other 3rd parties, however, may allow them at some point in the future in lieu of complying onsite. In this scenario, the tenant or third party is fully responsible for the ACP design, construction, operation, and long-term maintenance. The Authority would manage the tracking, banking, and trading of credits. Any future changes to allow participation by tenants or third parties would be subject to standard requirements for RWQCB review and approval.

The Authority maintains a web-based database to track and record sampling and monitoring efforts, inspections, audits, Authority and tenant documents, hotline issues, and to communicate with tenants and Authority employees regarding stormwater issues. The database interface is being developed to track and monitor the application of alternative compliance credits and deficits at the Airport. Through this alternative compliance credit verification process, the Authority ensures the integrity of the WQE framework by ensuring that the overall “balance of credits” remains at zero or above. This information will be maintained in the Authority’s database for all alternative compliance projects and will be made available to regulatory agencies upon request.

Glossary of Key Terms

50% Rule	Refers to an MS4 Permit standard for redevelopment PDPs (PDPs on previously developed sites) that defines whether the redevelopment PDP must meet storm water management requirements for the entire development or only for the newly created or replaced impervious surface. Refer to Section 1.7 .
Aggregate	Hard, durable material of mineral origin typically consisting of gravel, crushed stone, crushed quarry or mine rock. Gradation varies depending on application within a BMP as bedding, filter course, or storage.
Aggregate Storage Layer	Layer within a BMP that serves to provide a conduit for conveyance, detention storage, infiltration storage, saturated storage, or a combination thereof.
Alternative Compliance Programs	A program that allows PDPs to participate in an offsite mitigation project in lieu of implementing the onsite structural BMP performance requirements required under the MS4 Permit. Refer to Section 1.8 for more information on alternative compliance programs.
Bed Sediment	The part of the sediment load in channel flow that moves along the bed by sliding or saltation, and part of the suspended sediment load, that principally constitutes the channel bed.
Bedding	Aggregate used to establish a foundation for structures such as pipes, manholes, and pavement.
Biodegradation	Decomposition of pollutants by biological means.
Biofiltration BMPs	Biofiltration BMPs are shallow basins filled with treatment media and drainage rock that treat storm water runoff by capturing and detaining inflows prior to controlled release through minimal incidental infiltration, evapotranspiration, or discharge via underdrain or surface outlet structure. Treatment is achieved through filtration, sedimentation, sorption, biochemical processes and/or vegetative uptake. These BMPs must be sized to: [a] Treat 1.5 times the DCV not reliably retained onsite, OR [b] Treat the DCV not reliably retained onsite with a flow-through design that has a total volume, including pore spaces and pre-filter detention volume, sized to hold at least 0.75 times the portion of the DCV not reliably retained onsite. (See Section 5.5.3 and Appendix B.5 for illustration and additional information).
Biofiltration Treatment	Treatment from a BMP meeting the biofiltration standard.

Biofiltration with Partial Retention BMPs	Biofiltration with partial retention BMPs are shallow basins filled with treatment media and drainage rock that manage storm water runoff through infiltration, evapotranspiration, and biofiltration. Partial retention is characterized by a subsurface stone infiltration storage zone in the bottom of the BMP below the elevation of the discharge from the underdrains. The discharge of biofiltered water from the underdrain occurs when the water level in the infiltration storage zone exceeds the elevation of the underdrain outlet. (See Section 5.5.2.1 for illustration and additional information).
Bioretention BMPs	Vegetated surface water systems that filter water through vegetation and soil or engineered media prior to infiltrating into native soils. Bioretention BMPs in this Manual retain the entire DCV prior to overflow to the downstream conveyance system. (See Section 5.5.1.2 for illustration and additional information).
BMP	A procedure or device designed to minimize the quantity of runoff pollutants and/or volumes that flow to downstream receiving water bodies. Refer to Section 2.2.2.1 .
BMP Sizing Calculator	An on-line tool that was developed under the 2007 MS4 Permit to facilitate the sizing factor method for designing flow control BMPs for hydromodification management. The BMP Sizing Calculator has been discontinued as of June 30, 2014.
Cistern	A vessel for storing water. In this Manual, a cistern is typically a rain barrel, tank, vault, or other artificial reservoir.
Coarse Sediment Yield Area	A GLU with coarse-grained geologic material (material that is expected to produce greater than 50% sand when weathered). See the following terms modifying coarse sediment yield area: critical, potential critical.
Compact Biofiltration BMP	A biofiltration BMP, either proprietary or non-proprietary in origin, that is designed to provide storm water pollutant control within a smaller footprint than a typical biofiltration BMP, usually through use of specialized media that is able to efficiently treat high storm water inflow rates.
Conditions of Approval	Requirements a jurisdiction may adopt for a project in connection with a discretionary action (e.g., issuance of a use permit). COAs may include features to be incorporated into the final plans for the project and may also specify uses, activities, and operational measures that must be observed over the life of the project.

Contemporary Design Standards	This term refers to design standards that are reasonably consistent with the current state of practice and are based on desired outcomes that are reasonably consistent with the context of the MS4 Permit and Model BMP Design Manual. For example, a detention basin that is designed solely to mitigate peak flow rates would not be considered a contemporary water quality BMP design because it is not consistent with the goal of water quality improvement. Current state of the practice recognizes that a drawdown time of 24 to 72 hour is typically needed to promote settling. For practical purposes, design standards can be considered “contemporary” if they have been published within the last 10 years, preferably in California or Washington State, and are specifically intended for storm water quality management.
Continuous Simulation Modeling	A method of hydrological analysis in which a set of rainfall data (typically hourly for 30 years or more) is used as input, and a continuous runoff hydrograph is calculated over the same time period. Continuous simulation models typical track dynamic soil and storage conditions during and between storm events. The output is then analyzed statistically for the purposes of comparing runoff patterns under different conditions (for example, pre- and post-development-project).
Copermittees	See Jurisdiction.
Critical Channel Flow (Q_c)	The channel flow that produces the critical shear stress that initiates bed movement or that erodes the toe of channel banks. When measuring Q _c , it should be based on the weakest boundary material – either bed or bank.
Critical Coarse Sediment Yield Areas	A GLU with coarse-grained geologic material and high relative sediment production, where the sediment produced is critical to the receiving stream (a source of bed material to the receiving stream). See also: potential critical coarse sediment yield area.
Critical Shear Stress	The shear stress that initiates channel bed movement or that erodes the toe of channel banks. See also critical channel flow.
DCV	A volume of storm water runoff produced from the 85th percentile, 24-hour storm event. See Section 2.2.2.2 .
De Minimis DMA	De minimis DMAs are very small areas that are not considered to be significant contributors of pollutants and are considered not practicable to drain to a BMP. See Section 5.2.2 .
Depth	The distance from the top, or surface, to the bottom of a BMP component.
Detention	Temporarily holding back storm water runoff via a designed outlet (e.g., underdrain, orifice) to provide flow rate and duration control.
Detention Storage	Storage that provides detention as the outflow mechanism.

Development Footprint	The limits of all grading and ground disturbance, including landscaping, associated with a project.
Development Project	Construction, rehabilitation, redevelopment, or reconstruction of any public or private projects. Includes both new development and redevelopment. Also includes whole of the action as defined by CEQA. See Section 1.3 .
Direct Discharge	The connection of project site runoff to an exempt receiving water body, which could include an exempt river reach, reservoir or lagoon. To qualify as a direct discharge, the discharge elevation from the project site outfall must be at or below either the normal operating water surface elevation or the reservoir spillway elevation, and properly designed energy dissipation must be provided. “Direct discharge” may be more specifically defined by each municipality.
Direct Infiltration	Infiltration via methods or devices, such as dry wells or infiltration trenches, designed to bypass the mantle of surface soils that is unsaturated and more organically active and transmit runoff directly to deeper subsurface soils.
DMAs	See Section 3.3.3 .
Drawdown Time	The time required for a storm water detention or infiltration facility to drain and return to the dry-weather condition. For detention facilities, drawdown time is a function of basin volume and outlet orifice size. For infiltration facilities, drawdown time is a function of basin volume and infiltration rate.
Enclosed Embayments (Enclosed Bays)	Enclosed bays are indentations along the coast that enclose an area of oceanic water within distinct headlands or harbor works. Enclosed bays include all bays where the narrowest distance between the headlands or outermost bay works is less than 75 percent of the greatest dimension of the enclosed portion of the bay. Enclosed bays do not include inland surface waters or ocean waters. In San Diego: Mission Bay and San Diego Bay.
Environmentally Sensitive Areas (ESAs)	Areas that include but are not limited to all Clean Water Act Section 303(d) impaired water bodies; areas designated as Areas of Special Biological Significance by the State Water Board and SDRWQCB; State Water Quality Protected Areas; water bodies designated with the RARE beneficial use by the State Water Board and SDRWQCB; and any other equivalent environmentally sensitive areas which have been identified by the Copermittees.
Filter Course	Aggregate used to prevent particle migration between two different materials when storm water runoff passes through.
Filter Fabric	A permeable textile material, also termed a non-woven geotextile, that prevents particle migration between two different materials when storm water runoff passes through.

Filtration	Controlled seepage of storm water runoff through media, vegetation, or aggregate to reduce pollutants via physical separation.
Flow Control	Control of runoff rates and durations as required by the HMP.
Flow Control BMP	A structural BMP designed to provide control of post-project runoff flow rates and durations for the purpose of hydromodification management.
Flow-through Treatment	Treatment from a BMP meeting the flow-through treatment control standard.
Flow-Through Treatment BMPs	Flow-through treatment control BMPs are structural, engineered facilities that are designed to remove pollutants from storm water runoff using treatment processes that do not incorporate significant biological methods. Flow-through BMPs include vegetated swales, media filters, sand filters, and dry extended detention basins. (See Section 5.5.4 for illustration and additional information).
Forebay	An initial storage area at the entrance to a structural BMP designed to trap and settle out solid pollutants such as sediment in a concentrated location, to provide pre-treatment within the structural BMP and facilitate removal of solid pollutants during maintenance operations.
Full Infiltration	Infiltration of a storm water runoff volume equal to the DCV.
Geomorphic Assessment	A quantification or measure of the changing properties of a stream channel.
Geomorphically Significant Flows	Flows that have the potential to cause, or accelerate, stream channel erosion or other adverse impacts to beneficial stream uses. The range of geomorphically significant flows was determined as part of the development of the March 2011 Final HMP and has not changed under the 2013 MS4 Permit. However, under the 2013 MS4 Permit, Q2 and Q10 must be based on the pre-development condition rather than the pre-project condition, meaning that no pre-project impervious area may be considered in the computation of pre-development Q2 and Q10.
GLUs	Classifications that provide an estimate of sediment yield based upon three factors: geology, hillslope, and land cover. GLUs are developed based on the methodology presented in the SCCWRP Technical Report 605 titled “Hydromodification Screening Tools: GIS-Based Catchment Analyses of Potential Changes in Runoff and Sediment Discharge” (SCCWRP, 2010).
Gross Pollutants	In storm water, generally litter (trash), organic debris (leaves, branches, seeds, twigs, grass clippings), and coarse sediments (inorganic breakdown products from soils, pavement, or building materials).

Harvest and Use BMP	Harvest and use (aka rainwater harvesting) BMPs capture and store storm water runoff for later use. These BMPs are engineered to store a specified volume of water and have no design surface discharge until this volume is exceeded. (See Section 5.5.1.1 for illustration and additional information).
HMP	A plan implemented by the Copermittees so that post-project runoff shall not exceed estimated pre-development rates and/or durations by more than 10%, where increased runoff would result in increased potential for erosion or other adverse impacts to beneficial uses. The March 2011 Final HMP and the updated MS4 Permit are the basis of the flow control requirements of this Manual.
Hungry Water	Also known as "sediment-starved" water, "hungry" water refers to channel flow that is hungry for sediment from the channel bed or banks because it currently contains less bed material sediment than it is capable of conveying. The "hungry water" phenomenon occurs when the natural sediment load decreases and the erosive force of the runoff increases as a natural counterbalance, as described by Lane's Equation.
Hydraulic Head	Energy represented as a difference in elevation, typically as the difference between the inlet and outlet water surface elevation for a BMP.
Hydraulic Residence Time	The length of time between inflow and outflow that runoff remains in a BMP.
Hydrologic Soil Group	Classification of soils by the Natural Resources Conservation Service (NRCS) into A, B, C, and D groups according to infiltration capacity.
Hydromodification	The change in the natural watershed hydrologic processes and runoff characteristics (i.e., interception, infiltration, overland flow, interflow and groundwater flow) caused by urbanization or other land use changes that result in increased stream flows and sediment transport. In addition, alteration of stream and river channels, installation of dams and water impoundments, and excessive streambank and shoreline erosion are also considered hydromodification because of their disruption of natural watershed hydrologic processes.
Hydromodification Management BMP	A structural BMP for the purpose of hydromodification management, either for protection of critical coarse sediment yield areas or for flow control. See also flow control BMP.
Impervious Surface	Any material that prevents or substantially reduces infiltration of water into the soil.

Infeasible	As applied to BMPs, refers to condition in which a BMP approach is not practicable based on technical constraints specific to the site, including by not limited to physical constraints, risks of impacts to environmental resources, risks of harm to human health, or risk of loss or damage to property. Feasibility criteria are provided in this Manual.
Infiltration	In the context of LID, infiltration is defined as the percolation of water into the ground. Infiltration is often expressed as a rate (inches per hour), which is determined through an infiltration test. In the context of non-storm water, infiltration is water other than wastewater that enters a sewer system (including sewer service connections and foundation drains) from the ground through such means as defective pipes, pipe joints, connections, or manholes. Infiltration does not include, and is distinguished from, inflow [40 CFR 35.2005(20)].
Infiltration BMP	Infiltration BMPs are structural measures that capture, store and infiltrate storm water runoff. These BMPs are engineered to store a specified volume of water and have no design surface discharge (underdrain or outlet structure) until this volume is exceeded. These types of BMPs may also support evapotranspiration processes but are characterized by having their most dominant volume losses due to infiltration. (See Section 5.5.1.2 for illustration and additional information).
Jurisdiction	The term “jurisdiction” is used in this Manual to refer to individual Copermittees who have independent responsibility for implementing the requirements of the MS4 Permit.
LID	A storm water management and land development strategy that emphasizes conservation and the use of onsite natural features integrated with engineered, small-scale hydrologic controls to more closely reflect pre-development hydrologic functions. See Site Design .
Lower Flow Threshold	The lower limit of the range of flows to be controlled for hydromodification management. The lower flow threshold is the flow at which erosion of sediment from the stream bed or banks begins to occur. See also critical channel flow. For the San Diego region, the lower flow threshold shall be a fraction (0.1, 0.3, or 0.5) of the pre-development 2-year flow rate based on continuous simulation modeling (0.1Q ₂ , 0.3Q ₂ , or 0.5Q ₂).
Media	Storm water runoff pollutant treatment material, typically included as a permeable constructed bed or container (cartridge) within a BMP.
MEP	Refer to the definition in the MS4 Permit. [Appendix C, Definitions, Page C-6]

National Pollutant Discharge Elimination System	The national program for issuing, modifying, revoking and reissuing, terminating, monitoring and enforcing permits, and imposing and enforcing pretreatment requirements, under Sections 307, 318, 402, and 405 of the Clean Water Act.
New Development	Land disturbing activities; structural development, including construction or installation of a building or structure, the creation of impervious surfaces; and land subdivision.
O&M	Requirements in the MS4 Permit to inspect structural BMPs and verify the implementation of operational practices and preventative and corrective maintenance in perpetuity.
Partial Infiltration	Infiltration of a storm water runoff volume less than the DCV.
Partial Retention	Partial retention category is defined by structural measures that incorporate both infiltration (in the lower treatment zone) and biofiltration (in the upper treatment zone).
PDPs	As defined by the MS4 Permit provision E.3.b, land development projects that fall under the planning and building authority of the Copermittee for which the Copermittee must impose specific requirements in addition to those required of Standard Projects. Refer to Section 1.4 to determine if your project is a PDP.
PDPs with only Pollutant Control Requirements	PDPs that need to meet Source Control, Site Design and Pollutant Control Requirements (but are exempt from Hydromodification Management Requirements).
PDPs with Pollutant Control and Hydromodification Management Requirements	PDPs that need to meet Source Control, Site Design, Pollutant Control and Hydromodification Management Requirements.
Point of Compliance	1. For channel screening and determination of low flow threshold: the point at which collected storm water from a development is delivered from a constructed or modified drainage system into a natural or un-lined channel. POC for channel screening may be located onsite or offsite, depending on where runoff from the project meets a natural or un-lined channel. 2. For flow control: the point at which pre-development and post-development flow rates and durations will be compared. POC for flow control is typically onsite. A project may have a different POC for channel screening vs. POC for flow control if runoff from the project site is conveyed in hardened systems from the project site boundary to the natural or un-lined channel.
Pollutant Control	Control of pollutants via physical, chemical or biological processes

Pollution Prevention	Pollution prevention is defined as practices and processes that reduce or eliminate the generation of pollutants, in contrast to source control BMPs, treatment control BMPs, or disposal.
Post-Project Hydrology Flows, Volumes	The peak runoff flows and runoff volume anticipated after the project has been constructed taking into account all permeable and impermeable surfaces, soil and vegetation types and conditions after landscaping is complete, detention or retention basins or other water storage elements incorporated into the site design, and any other site features that would affect runoff volumes and peak flows.
Potential Critical Coarse Sediment Yield Area	A GLU with coarse-grained geologic material and high relative sediment production, as defined in the Regional WMAA. The Regional WMAA identified GLUs as potential critical coarse sediment yield areas based on slope, geology, and land cover. GLU analysis does not determine whether the sediment produced is critical to the receiving stream (a source of bed material to the receiving stream) therefore the areas are designated as potential.
Pre-Development Runoff Conditions	Approximate flow rates and durations that exist or existed onsite before land development occurs. For new development projects, this equates to runoff conditions immediately before any new project disturbance or grading. For redevelopment projects, this equates to runoff conditions from the project footprint assuming infiltration characteristics of the underlying soil, and existing grade. Runoff coefficients of concrete or asphalt must not be used. A redevelopment PDP must use available information pertaining to existing underlying soil type and onsite existing grade to estimate pre-development runoff conditions.
Pre-Project Condition	The condition prior to any project work or the existing condition. Note that pre-project condition and pre-development condition will not be the same for redevelopment projects.
Pretreatment	Removal of gross solids, including organic debris and coarse sediment, from runoff to minimize clogging and increase the effectiveness of BMPs.
Project Area	All areas proposed by an applicant to be altered or developed, plus any additional areas that drain on to areas to be altered or developed. Also see Section 1.3 .
Project Submittal	Documents submitted to a jurisdiction or Copermittee in connection with an application for development approval and demonstrating compliance with MS4 Permit requirements for the project. Specific requirements vary from municipality to municipality.
Proprietary BMP	BMP designed and marketed by private business for treatment of storm water. Check with P&EAD prior to proposing to use a proprietary BMP.

Receiving Waters	See Waters of the United States .
Redevelopment	The creation and/or replacement of impervious surface on an already developed site. Examples include the expansion of a building footprint, road widening, and the addition to or replacement of a structure. Replacement of impervious surfaces includes any activity where impervious material(s) are removed, exposing underlying soil during construction. Redevelopment does not include routine maintenance activities, such as trenching and resurfacing associated with utility work; pavement grinding; resurfacing existing roadways, sidewalks, pedestrian ramps, or bike lanes on existing roads; and routine replacement of damaged pavement, such as pothole repair.
Retrofitting	Storm water management practice put into place after development has occurred in watersheds where the practices previously did not exist or are ineffective. Retrofitting of developed areas is intended to improve water quality, protect downstream channels, reduce flooding, or meet other specific objectives. Retrofitting developed areas may include but is not limited to replacing roofs with green roofs, disconnecting downspouts or impervious surfaces to drain to pervious surfaces, replacing impervious surfaces with pervious surfaces, installing rain barrels, installing rain gardens, and trash area enclosures.
Regional Water Quality Control Board (SDRWQCB)	California RWQCBs are responsible for implementing pollution control provisions of the Clean Water Act and California Water Code within their jurisdiction. There are nine California RWQCBs.
Retention (Retention BMPs)	A category of BMP that does not have any service outlets that discharge to surface water or to a conveyance system that drains to surface waters for the design event (i.e., 24-hour, 85 th percentile). Mechanisms used for storm water retention include infiltration, evapotranspiration, and use of retained water for non-potable or potable purposes.
Saturated Storage	Storage that provides a permanent volume of water at the bottom of the BMP as an anaerobic zone to promote denitrification and/or thermal pollution control. Also known as internal water storage or a saturation zone.
Self-mitigating Areas	A natural, landscaped, or turf area that does not generate significant pollutants and drains directly offsite or to the public storm drain system without being treated by a structural BMP. See Section 5.2.1 .
Self-retaining DMA via Qualifying Site Design BMPs	An area designed to retain runoff to fully eliminate storm water runoff from the 85 th percentile 24 hours storm event; See Section 5.2.3 .

SIC	A federal government system for classifying industries by 4-digit code. It is being supplanted by the North American Industrial Classification System but SIC codes are still referenced by the Regional Water Board in identifying development sites subject to regulation under the National Pollutant Discharge Elimination System permit. Information and an SIC search function are available at https://www.osha.gov/pls/imis/sicsearch.html
Significant Redevelopment	Redevelopment that meets the definition of a “PDP” in this Manual. See Section 1.4 .
Site Design	A storm water management and land development strategy that emphasizes conservation of natural features and the use of onsite natural features integrated with engineered, small-scale hydrologic controls to more closely reflect pre-development hydrologic functions.
Sizing Factor Method	A method for designing flow control BMPs for hydromodification management using sizing factors developed from unit area continuous simulation models.
Sorption	Physical and/or chemical process where pollutants are taken out of runoff through attachment to another substance.
Source Control	Land use or site planning practices, or structures that aim to prevent runoff pollution by reducing the potential for contamination at the source of pollution. Source control BMPs minimizes the contact between pollutants and storm water runoff. Examples include roof structures over trash or material storage areas, and berms around fuel dispensing areas. Source control BMPs are described within this Manual.
Standard Project	Any development project that is not defined as a PDP by the MS4 Permit.
Storm Water Conveyance System	A conveyance or system of conveyances (including roads with drainage systems, municipal streets, catch basins, curbs, gutters, ditches, man-made channels, or storm drains): (i) Owned or operated by a State, city, town, borough, county, parish, district, association, or other public body (created by or pursuant to State law) having jurisdiction over disposal of sewage, industrial wastes, storm water, or other wastes, including special districts under State law such as a sewer district, flood control district or drainage district, or similar entity, or an Indian tribe or an authorized Indian tribal organization, or designated and approved management agency under section 208 of the Clean Water Act that discharges to waters of the United States; (ii) Designated or used for collecting or conveying storm water; (iii) Which is not a combined sewer; (iv) Which is not part of the Publicly Owned Treatment Works as defined at 40 CFR 122.26.

Storm Water Pollutant Control BMP	A category of storm water management requirements that includes treatment of storm water to remove pollutants by measures such as retention, biofiltration, and/or flow-through treatment control, as specified in this Manual. Also called a Pollutant Control BMP.
Structural BMP	Throughout the Manual, the term "structural BMP" is a general term that encompasses the pollutant control BMPs and hydromodification BMPs required for PDPs under the MS4 Permit. A structural BMP may be a pollutant control BMP, a hydromodification management BMP, or an integrated pollutant control and hydromodification management BMP. Structural BMPs as defined in the MS4 Permit are: a subset of BMPs which detains, retains, filters, removes, or prevents the release of pollutants to surface waters from development projects in perpetuity, after construction of a project is completed.
Subgrade	In-situ soil that lies underneath a BMP.
Tributary Area	The total surface area of land or hardscape that contributes runoff to the BMP; including any offsite or onsite areas that comingles with project runoff and drains to the BMP. Refer to Section 3.3.3 for additional guidance Also termed the drainage area or catchment area.
Unified BMP Design Approach	This term refers to the standardized process for site and watershed investigation, BMP selection, BMP sizing, and BMP design that is outlined and described in this Manual with associated appendices and templates. This approach is considered to be “unified” because it represents a pathway for compliance with MS4 Permit requirements that is anticipated to be reasonably consistent across the local jurisdictions in San Diego County. In contrast, applicants may choose to take an alternative approach where they demonstrate to the satisfaction of the Copermittee, in their submittal, compliance with applicable performance standards without necessarily following the process identified in this Manual.
Upper Flow Threshold	The upper limit of the range of flows to be controlled for hydromodification management. For the San Diego region, the upper flow threshold shall be the pre-development 10-year flow rate (Q10) based on continuous simulation modeling.
Vactor	Refers to a sewer or storm drain cleaning truck equipped to remove materials from sewer or storm drainpipes or structures, including some storm water BMPs.
Vector	An animal or insect capable of transmitting the causative agent of human disease. An example of a vector in San Diego County that is of concern in storm water management is a mosquito.

Water Quality Improvement Plan

Copermittees are required to develop a Water Quality Improvement Plan for each Watershed Management Area in the San Diego Region. The purpose of the Water Quality Improvement Plans is to guide the Copermittees' jurisdictional runoff management programs towards achieving the outcome of improved water quality in MS4 discharges and receiving waters. WQIPs requirements are defined in the MS4 Permit provision B.

Waters of the United States

Surface bodies of water, including naturally occurring wetlands, streams (perennial, intermittent, and ephemeral (exhibiting bed, bank, and ordinary high water mark)), creeks, rivers, reservoirs, lakes, lagoons, estuaries, harbors, bays and the Pacific Ocean which directly or indirectly receive discharges from storm water conveyance systems. The Copermittee shall determine the definition for wetlands and the limits thereof for the purposes of this definition, which shall be as protective as the federal definition utilized by the United States Army Corps of Engineers and the United States Environmental Protection Agency. Constructed wetlands are not considered wetlands under this definition, unless the wetlands were constructed as mitigation for habitat loss. Other constructed BMPs are not considered receiving waters under this definition, unless the BMP was originally constructed within the boundaries of the receiving waters. Also see MS4 permit definition.

Watershed Management Area

The ten areas defined by the SDRWQCB in Regional MS4 Permit provision B.1, Table B-1. Each Watershed Management Area is defined by one or more Hydrologic Unit, major surface water body, and responsible Copermittee.

Watershed Management Area Analysis

For each Watershed Management Area, the Copermittees have the option to perform a WMAA for the purpose of developing watershed-specific requirements for structural BMP implementation. Each WMAA includes: GIS layers developed to provide physical characteristics of the watershed management area, a list of potential offsite alternative compliance projects, and areas exempt from hydromodification management requirements.

This page intentionally left blank