



AIRPORT LAND USE COMMISSION
San Diego County Regional Airport Authority

San Diego International Airport

AIRPORT LAND USE
COMPATIBILITY PLAN

FEBRUARY 2014



San Diego International Airport

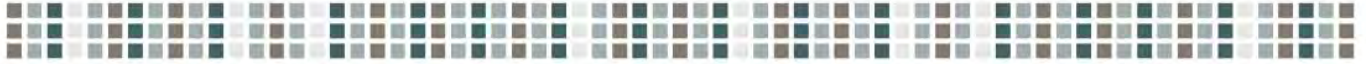

San Diego International Airport Land Use Compatibility Plan

PREPARED FOR:

San Diego County Regional Airport Authority

PREPARED BY:

RICONDO & ASSOCIATES, INC.

February 2014

Ricondo & Associates, Inc. (R&A) prepared this document for the stated purposes as expressly set forth herein and for the sole use of San Diego County Regional Airport Authority and its intended recipients. The techniques and methodologies used in preparing this document are consistent with industry practices at the time of preparation.

Table of Contents

CHAPTER 1	Implementation	1-1
1.1	Purpose and Contents of the Plan.....	1-1
1.2	Effective Date and Amendment	1-2
	1.2.1 Effective Date	1-2
	1.2.2 Amendment of this ALUCP.....	1-2
1.3	State Requirements and Guidance.....	1-3
	1.3.1 State ALUC Statute.....	1-3
	1.3.2 California Airport Land Use Planning Guidelines	1-4
1.4	Geographic Scope: the Airport Influence Area.....	1-4
	1.4.1 Real Estate Disclosure	1-7
1.5	Local Agencies and Stakeholders Subject to this ALUCP.....	1-7
1.6	Existing Land Uses	1-8
	1.6.1 Existing Incompatible Land Uses	1-9
1.7	Single-Family Residence Development Right.....	1-11
1.8	Governing ALUCP.....	1-11
	1.8.1 Changes to Land Use Projects with Previous Consistency Determinations	1-11
1.9	ALUC Review Process before Local Agency Implementation	1-12
	1.9.1 Review Area 1.....	1-12
	1.9.2 Review Area 2.....	1-15
	1.9.3 Consistency Determination Review Process	1-15
1.10	Local Agency Implementation	1-16
	1.10.1 Local Agency Requirements and Responsibilities.....	1-16
	1.10.2 Establishing Consistency of Local Agency Land Use Plans and Regulations	1-19

Table of Contents (continued)

1.11	ALUC Review after Local Agency Implementation	1-20
1.11.1	Review of Land Use Plans and Regulations.....	1-20
1.11.2	Review of Land Use Projects	1-20
1.11.3	Voluntary Review of Land Use Projects	1-20
1.11.4	Consistency Determination Review Process	1-25
1.12	ALUC Review of Proposed Airport Plans and Projects.....	1-25
1.12.1	Airport Plans and Projects	1-25
1.12.2	ALUC Actions on Airport Plans.....	1-25
1.12.3	Consistency Determination Result	1-25
1.12.4	Limit of ALUC Authority Over Airport	1-26
CHAPTER 2	Noise Compatibility Policies and Standards	2-1
CHAPTER 3	Safety Compatibility Policies and Standards	3-1
3.1	Residential Land Uses.....	3-11
3.2	Nonresidential Land Uses.....	3-17
3.3	Supplemental Safety Compatibility Policies.....	3-18
CHAPTER 4	Airspace Protection Policies and Standards	4-1
4.1	FAA Notification of Proposed Construction or Alteration.....	4-5
4.2	Hazards.....	4-9
4.3	Threshold Siting Surfaces	4-9
4.4	Compatibility of Structures and Objects	4-15
4.5	Standards for the Protection of Flight Safety	4-16
4.6	Avigation Easements.....	4-19
CHAPTER 5	Overflight Compatibility Policies	5-1

Table of Contents (continued)

CHAPTER 6 Examples.....	6-1
Example #1: New Residential Development.....	6-1
Example #2: New Residential Development.....	6-7
Example #3: New Nonresidential Development.....	6-13
Example #4: Nonresidential Development in Existing Building.....	6-19
Example #5: New Mixed-Use Development.....	6-25

List of Appendices

Appendix A	Land Use Classification Definitions
Appendix B	Implementation Tools and Documents
Appendix C	References and Guidance
Appendix D	Definitions and Acronyms
Appendix E	Technical Analysis
Appendix F	Correspondence with the Division of Aeronautics
Appendix G	Aircraft Bird Strikes in California

List of Tables

Table 2-1	Noise Compatibility Standards.....	2-5
Table 3-1	Safety Compatibility Standards.....	3-5
Table 3-2	Examples.....	3-21

List of Exhibits

Exhibit 1-1	Airport Influence Area	1-5
Exhibit 1-2	ALUC Review Before Local Agency Implementation	1-13
Exhibit 1-3	Consistency Determination Review Process.....	1-17
Exhibit 1-4	ALUC Review After Local Agency Implementation – Land Use Plans and Regulations	1-21
Exhibit 1-5	ALUC Review After Local Agency Implementation – Land Use Projects.....	1-23
Exhibit 2-1	Noise Contour Map.....	2-3
Exhibit 2-2	Residential Use Allowed under the General/Community Plans Above 70 dB CNEL.....	2-7
Exhibit 3-1	Safety Compatibility Zones.....	3-3
Exhibit 3-2	Runway Protection Zones and Controlled Activity Areas	3-13
Exhibit 3-3	Residential Use Allowed under the General/Community Plans Inside the Safety Compatibility Zones	3-15
Exhibit 4-1	Airspace Protection Boundary	4-3
Exhibit 4-2	Notice of Federal Requirement	4-7
Exhibit 4-3	Threshold Siting Surfaces Profile	4-11
Exhibit 4-4	Displaced Runway Threshold—Example	4-13
Exhibit 5-1	Overflight Area Boundary.....	5-3



CHAPTER 1

Implementation

This Airport Land Use Compatibility Plan (ALUCP) for San Diego International Airport (SDIA or the Airport) is the fundamental tool used by the San Diego County Airport Land Use Commission (ALUC) to promote airport land use compatibility in the Airport environs.

This ALUCP was prepared by the San Diego County Regional Airport Authority (SDCRAA), acting in its capacity as the San Diego County ALUC, which manages the day-to-day operations at the Airport and serves as the region's ALUC. This ALUCP replaces the previous compatibility plan originally adopted in 1992 and amended in 1994 and 2004.

1.1 Purpose and Contents of the Plan

Consistent with State law, the purpose of this ALUCP is to promote compatibility between the Airport and surrounding future land uses to:

- Provide for the orderly development of the Airport and the area surrounding the Airport
- Protect public health, safety and welfare in areas around the Airport¹

This ALUCP is distinct from the Airport Master Plan. While the Airport Master Plan describes plans for development on Airport property, this ALUCP focuses on policies guiding future development and redevelopment in the area surrounding the Airport.

This ALUCP provides airport land use compatibility policies and standards related to four airport-related factors: noise, safety, airspace protection and overflight. The goals of these land use compatibility policies and standards are as follows.

¹ California Public Utilities Code §21675(a).

Compatibility Factor	Goals
Noise	Ensures that new development within the noise contours is compatible with aircraft noise by: <ul style="list-style-type: none"> • Limiting new noise-sensitive development within the noise compatibility boundary • Ensuring that any new noise-sensitive development includes sound attenuation • Obtaining aviation easements for new noise-sensitive development²
Safety	Protects the public health, safety, and welfare by: <ul style="list-style-type: none"> • Prohibiting certain sensitive land uses within the safety zones • Limiting the number of people in areas subject to the highest risk of aircraft accidents
Airspace Protection	Ensures that new development is consistent with: <ul style="list-style-type: none"> • Assuring flight safety by limiting the height of new structures and objects • Preserving the operational capability of the Airport • Preventing further reduction of available runway landing distance
Overflight	Ensures that prospective buyers of new housing within areas subject to aircraft overflights are informed about the potential effects of overflights by: <ul style="list-style-type: none"> • Ensuring that owners and developers of new residential projects provide notice of the presence of aircraft overflight to prospective buyers

1.2 Effective Date and Amendment

1.2.1 Effective Date

This ALUCP becomes effective on the date of its adoption by the ALUC, superseding the previous ALUCP for the Airport adopted in 1992 and amended in 1994 and 2004.

If any portion of this ALUCP is invalidated by court action, other portions of this ALUCP remain unaffected and in full force.

1.2.2 Amendment of this ALUCP

Amendment of this ALUCP may be made once per calendar year, as provided by law.³ ALUCP amendments may address any issue deemed appropriate by the ALUC. State law also requires that the ALUC review updates to airport master plans, airport layout plans, and proposals for

² Title 21, California Code of Regulations, Subchapter 6, *Noise Standards*, Section 5037(f).

³ California Public Utilities Code §21675(a).

airport expansion.⁴ The ALUCP must be amended as needed to reflect updates and revisions to airport plans.

1.3 State Requirements and Guidance

1.3.1 State ALUC Statute

State law requires the San Diego County ALUC to prepare ALUCPs for all public-use and military airports in the County.⁵ The Legislature assigned the ALUC function in San Diego County to SDCRAA.⁶

State law requires the California Department of Transportation (Caltrans) to provide guidance to ALUCs in preparing ALUCPs. The Caltrans Division of Aeronautics publishes the *California Airport Land Use Planning Handbook* (the Handbook) to fulfill this responsibility. State law requires ALUCs to be guided by the information in the Handbook when preparing ALUCPs.⁷ ALUCs have a degree of flexibility and discretion to make planning decisions they consider appropriate for the airports within their jurisdiction.

State law requires that ALUCs base their ALUCPs on a long-range airport master plan or airport layout plan (ALP) which reflects the anticipated growth of the airport for at least the next 20 years.⁸ State law also includes requirements for ALUC review of land use plans and regulations, other land use projects and revisions to airport master plans.⁹

After the ALUC adopts an ALUCP, local agencies with jurisdiction within the Airport Influence Area (AIA), defined in **Section 1.4**, must either amend their land use plans and regulations to be consistent with the ALUCP or overrule the ALUCP.¹⁰

A local agency can overrule the ALUCP (or a part of the ALUCP) with a two-thirds majority vote of its governing body. The overrule resolution must include findings describing how the local agency's current land use plans and regulations achieve the objectives of the State ALUC statute.¹¹

In addition to agencies with land use regulatory authority (such as cities and counties), special districts, community college districts and school districts are also subject to the requirements of the State ALUC statute.¹²

⁴ California Public Utilities Code §§21675(a), 21676(c).

⁵ California Public Utilities Code §21675.

⁶ California Public Utilities Code §21670.3.

⁷ California Public Utilities Code §21674.7.

⁸ California Public Utilities Code §21675(a).

⁹ California Public Utilities Code §§21675.2, 21676, 21676.5.

¹⁰ California Public Utilities Code §§21675.1(d), 21676, 21676.5.

¹¹ California Public Utilities Code §§21676 and 21676.5.

¹² California Public Utilities Code §21670(f).

What are Land Use Plans and Regulations?	What are Land Use Projects?
<p>Land use plans and regulations include any general plan, community plan, specific plan, precise plan, zoning ordinance, rezone, building regulation or any amendments to these policy and regulatory documents. Land use plans and regulations also include any school district, community college district or special district master plans or amendments to master plans.</p>	<p>A land use project is a proposed development that requires a ministerial or discretionary permit or approval from a local agency or that is sponsored by a local agency and involves any of the following:</p> <ul style="list-style-type: none"> • Construction of a new building • Enlargement of the floor area of an existing building • The subdivision of land • A change of use within an existing structure (land uses are defined in Appendix A of this ALUCP) • An increase in the height of a structure or object <p>When a land use project includes a land use plan amendment or rezone, it is reviewed as a land use plan and regulation.</p>

1.3.2 California Airport Land Use Planning Guidelines

The latest edition of the Handbook was released in October 2011. The Handbook provides guidance on the delineation of airport compatibility factor boundaries, the policies that should apply within those areas, and the administration of ALUCPs. The guidance in the Handbook is intended to serve as the starting point for compatibility planning around individual airports.¹³ The policies and maps in this ALUCP take into account the guidance provided by the current edition of the Handbook.

1.4 Geographic Scope: the Airport Influence Area

The AIA defines the boundary where this ALUCP applies. The AIA is “the area in which current and projected future airport-related noise, safety, airspace protection, or overflight factors/layers may significantly affect land use or necessitate restrictions on land use.”¹⁴

Within the AIA, various boundaries applying to each of the four compatibility factors are defined. The AIA is divided into Review Areas 1 and 2, as depicted in **Exhibit 1-1**. The differences in impacts within these two areas require different policies and review procedures.

¹³ California Department of Transportation, Division of Aeronautics, *California Airport Land Use Planning Handbook*, October 2011, p. 3-16. 3-20, 4-12, 4-15, 4-16, 4-32, 4-40.

¹⁴ California Business and Professions Code §11010(b)(13)(B).

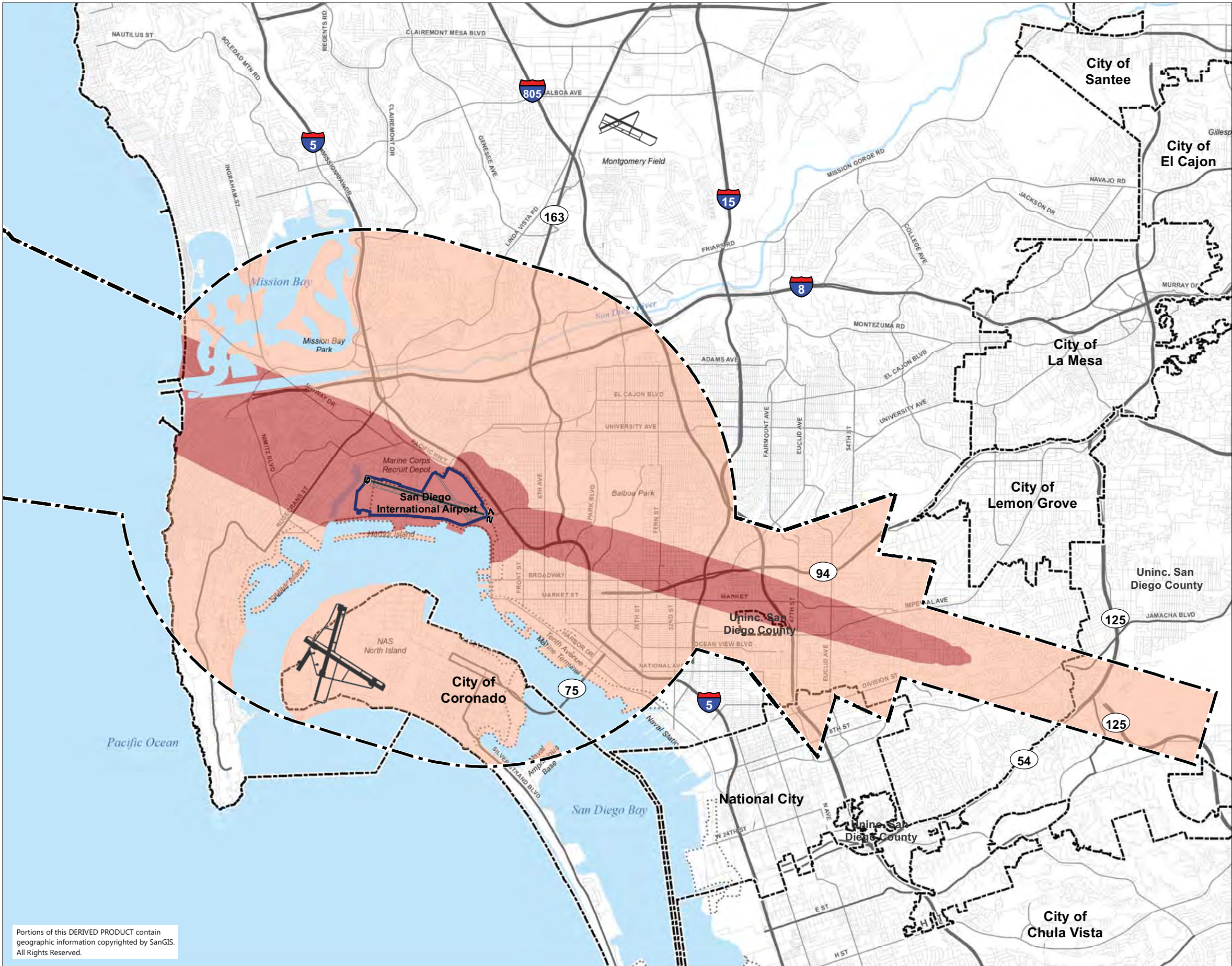

LEGEND

- Major Roads
- Highways
- - - Municipal Boundaries
- ▭ Airport Property Boundary
- ⋯ San Diego Unified Port District Planning Jurisdiction Boundary

Airport Influence Area (AIA)

- ▭ Airport Influence Area: the AIA is the area within which real estate disclosure is required, under state law.¹
- ▭ Review Area 1: the combination of the 60 dB CNEL noise contour, the outer boundary of all safety zones, and the Threshold Siting Surfaces (TSSs).
- ▭ Review Area 2: the combination of the airspace protection and overflight boundaries beyond Review Area 1.



Note 1. California Business and Professions Code §11010(a) and (b)(13); California Civil Code §§1102.6, 1103.4 and 1353; California Code of Civil Procedure §731a.

Sources: San Diego Geographic Information Source (SanGIS), 2008 and 2011 (municipal boundaries, roads and highways); Ricondo & Associates, Inc., January 2012, based on previous steering committee reports (review area 1 and 2 boundaries).

Prepared by: Ricondo & Associates, Inc., October 2013.

**Exhibit 1-1
Airport
Influence Area**

Portions of this DERIVED PRODUCT contain geographic information copyrighted by SanGIS. All Rights Reserved.

- Review Area 1 is defined by the combination of the 60 dB CNEL noise contour, the outer boundary of all safety zones, and the airspace Threshold Siting Surfaces (TSSs). All policies and standards apply within Review Area 1.
- Review Area 2 is defined by the combination of the airspace protection and overflight boundaries beyond Review Area 1. Only airspace protection and overflight policies and standards apply within Review Area 2.

What is a Threshold Siting Surface?

A Threshold Siting Surface (TSS) defines critical airspace that must be protected to allow for safe approaches to runways. Any objects penetrating the TSSs would cause the runway thresholds to be further displaced, reducing available landing distances.

1.4.1 Real Estate Disclosure

Sellers of property and their agents are required by State law to disclose to prospective buyers of new and existing residential properties when such property is located within the AIA, as shown on **Exhibit 1-1**.¹⁵ The real estate disclosure requirements apply within the AIA. The disclosure provisions of State law are deemed mandatory for any new dwelling unit and shall continue in effect as ALUC policy even if the State law is revised or rescinded.

1.5 Local Agencies and Stakeholders Subject to this ALUCP

This ALUCP applies to all local agencies within the AIA. In this ALUCP, the term “local agency” includes the cities of San Diego, Coronado, and National City; the County of San Diego; ~~Civic San Diego~~; the San Diego Unified Port District; and all school, community college and special districts within the AIA. This ALUCP does not apply to any property owned by the United States government or any Native American tribe.

Those affected most directly by the ALUCP include three groups of stakeholders – the ALUC, local agencies and project sponsors. The following table briefly describes these stakeholders and their roles in using or implementing the ALUCP.

¹⁵ California Business and Professions Code §11010(a) and (b)(13); California Civil Code §§1102.6, 1103.4 and 1353; California Code of Civil Procedure §731a.

	ALUC	Local Agencies	Project Sponsors
Stakeholders	The SDCRAA Board serves as the ALUC for San Diego County.	In this ALUCP, the term “local agency” means the County of San Diego and any municipality with land use regulatory and permitting authority (including the San Diego Unified Port District). It also includes school districts, community college districts and special districts with the authority to build and operate public buildings and facilities.	In this ALUCP, the term “project sponsor” refers to any person or entity having a legal interest in a property, including a local agency, landowner or nonresidential tenant, who submits an application to a local agency for review of a project proposed on such property.
How they use this ALUCP	This ALUCP is used by the ALUC and its staff to fulfill its mandate to promote airport land use compatibility in the environs of the Airport.	This ALUCP provides compatibility policies and standards that local agencies must incorporate into their land use plans and regulations. ¹⁶	Project sponsors must comply with the compatibility policies and standards of this ALUCP in designing and building projects.

1.6 Existing Land Uses

Under State law, an ALUC has no authority over existing land use.¹⁷ An exception is for existing incompatible land uses that are intensified, as described in **Section 1.6.1**.

A land use project will be considered an existing land use when a “vested right” is obtained in any of the following ways:

- An approved and unexpired vesting tentative map (pursuant to California Government Code §66498.1); or
- An executed and valid development agreement (pursuant to California Government Code §65866); or
- Issuance of a valid building permit with substantial work performed and substantial liabilities incurred in good faith reliance on the permit¹⁸

An extension of time, or a proposed modification to an existing land use project that the local agency has determined to be in substantial conformance with previous approvals, is not

¹⁶ State law allows local agencies to overrule the ALUCP and other ALUC decisions, after meeting specific requirements per California Public Utilities Code §§21676 and 21676.5.

¹⁷ California Public Utilities Code §§21670(a)(2), 21674(a).

¹⁸ Pursuant to the California Supreme Court decision in *Avco Community Developers, Inc. v. South Coast Regional Com.* (1976) 17 Cal.3d 785,791, and its progeny.

subject to consistency review. If the proposed modification is determined not to be in substantial conformance, it must be submitted for consistency review.

The determination of whether a land use plan, regulation or project meets the criteria of an existing land use must be made by the ALUC (or the local agency post implementation).

1.6.1 Existing Incompatible Land Uses

An existing incompatible land use is inconsistent with one or more of the policies and standards of this ALUCP and is not subject to this ALUCP unless it requires enlargement or reconstruction after the adoption of this ALUCP. Existing incompatible land uses must be evaluated according to the applicable compatibility factors listed below.

Repair, maintenance or remodeling within an existing building footprint is not subject to the policies in this section unless the work would result in a height that would increase any degree of airspace protection incompatibility.

1.6.1.1 Noise

An existing incompatible land use for noise is not sound attenuated to the levels required by **Table 2-1** in **Chapter 2** and/or has not dedicated an aviation easement to the Airport Authority as required by **Table 2-1**. If the existing use is not already attenuated, enlargement and reconstruction of residential and nonresidential uses within the noise contours shown on **Exhibit 2-1** are subject to consistency review and the following requirements:

1. Additional sleeping rooms (bedrooms or rooms used primarily for sleeping) in residential, hotel/motel and institutional uses must be sound-attenuated as required by **Table 2-1** (existing sleeping rooms do not require attenuation)
2. Reconstructed buildings must be fully sound-attenuated as required by **Table 2-1**
3. An aviation easement must be recorded as required by **Table 2-1**

1.6.1.2 Safety

An existing incompatible land use for safety either exceeds the residential density and/or nonresidential intensity levels listed in **Table 3-1** in **Chapter 3**. If it exceeds either limit, enlargement and reconstruction are subject to consistency review and the following requirements:

1. Residential Uses Only
 - An existing incompatible residential use may be expanded in building area or reconstructed if there is no increase in density. A second dwelling unit, as defined by state law¹⁹, is not counted toward this limitation.

¹⁹ California Government Code §§65852.150, 65852.

2. Nonresidential Uses Only

- An existing incompatible nonresidential use may be expanded in building area or reconstructed if there is no increase in the intensity of the use.
- Existing incompatible children's schools (grades K–12) may be expanded, replaced or reconstructed if required by State law, ~~but no new assembly facilities with capacities of 50 or more people are allowed.~~

3. Additional Limitations for Safety Zone 1

- Residential uses are not allowed.
- Reconstruction of existing incompatible land uses is allowed only if the structure or object is destroyed by calamity (e.g., fire, earthquake, etc.). Reconstructed buildings are limited to the same size and usage intensity of the original building. The size can only be increased if required for compliance with local building codes.
- Remodeling is allowed if no more than 50 percent of the exterior walls are removed and there is no increase in the building footprint or floor area. No increase in intensity can be associated with the remodeling.

1.6.1.3 Airspace

Enlargement and reconstruction of an existing incompatible land use are not subject to consistency review for airspace purposes, unless the work would result in an increase in height that creates an obstruction or hazard (see **Section 4.2** in **Chapter 4**). If consistency review is required, an avigation easement must be recorded if:

1. The structure or object exceeds the obstruction standards of Part 77, as determined by the Federal Aviation Administration (FAA).
2. The existing incompatible land use is on a site where the existing ground level penetrates a Part 77 airspace surface.

1.6.1.4 Overflight

Since overflight only applies to new residential units, enlargement and reconstruction of existing residences within the overflight boundary shown on **Exhibit 5-1** are not subject to consistency review.

1.6.1.5 Discontinuance

An existing incompatible land use (as indicated in **Table 2-1** and **Table 3-1**) that has been abandoned for more than 24 months cannot qualify as an existing use. An incompatible land use may be re-established prior to 24 months (as determined by the local agency) following initial abandonment without being subject to consistency review. Any resumption of a previously existing incompatible use may not add additional area or height which would increase any degree of incompatibility or increase intensity beyond what existed immediately prior to abandonment of the use.

1.7 Single-Family Residence Development Right

Notwithstanding any other policies of this ALUCP, construction of a single-family residence, including a second dwelling unit, is allowed subject to the following considerations:

1. The property is not located in Safety Zone 1
2. Each dwelling unit must be sound-attenuated, if required by the noise compatibility policies and standards of this ALUCP
3. An aviation easement or overflight agreement must be recorded, if required by the compatibility policies and standards of this ALUCP
4. Each dwelling unit must comply with the airspace protection policies and standards of this ALUCP

1.8 Governing ALUCP

Land use plans and regulations for which an application to the ALUC was deemed complete prior to the adoption of this ALUCP will be reviewed under the previous ALUCP. Land use plans and regulations for which an application is deemed complete by the ALUC after the adoption of this ALUCP will be reviewed under this ALUCP.

Land use projects for which an application has been deemed complete per the Government Code by the local agency prior to the adoption of this ALUCP are subject to the previous ALUCP, provided that the ALUC has received an application for a consistency determination within 100 days of the effective date of the new ALUCP. If the application for consistency determination is incomplete, the local agency will have an additional 20 days to complete the application. Land use project applications deemed complete by the local agency after the adoption of the new ALUCP are subject to this ALUCP.

What is consistency?

Consistency means being compatible with each applicable compatibility factor (noise, safety, airspace protection and overflight). A project must comply with each applicable compatibility factor in order to be deemed consistent by the ALUC.

1.8.1 Changes to Land Use Projects with Previous Consistency Determinations

Land use projects with consistency determinations made under the previous ALUCP may not be modified after adoption of the new ALUCP, if the change would result in any of the following:

- An increase in the proposed residential density or nonresidential intensity which would exceed the respective limits of the new ALUCP²⁰
- A change to a land use that is incompatible with the new ALUCP²¹
- A proposed height which would penetrate the airport threshold siting surfaces (TSSs) or create a hazard or obstruction as determined by the FAA
- A characteristic that would create a hazard to air navigation (e.g., glare, thermal plumes, bird attractants)²²

Land use project modifications that do not violate any of the four preceding bullets are allowed, provided that notice of the change is given to the ALUC.

Land use projects with consistency determinations made after the adoption of this ALUCP require additional consistency review for any changes which would increase residential density or nonresidential intensity. This will ensure any applicable sound attenuation, aviation easement or overflight agreement conditions will apply to any increases. The last three preceding bullet conditions also require additional consistency review.

1.9 ALUC Review Process before Local Agency Implementation

This section describes the process for consistency determinations before a local agency:

- Amends its land use plans and regulations to be consistent with this ALUCP, or
- Overrules all or part of this ALUCP

Exhibit 1-2 depicts the ALUC review process for land use plans, regulations and projects before a local agency has implemented or overruled this ALUCP.

1.9.1 Review Area 1

ALUC review is required for all land use plans, regulations and projects located in Review Area 1. ALUC staff may make a consistency determination for any land use plan, regulation or project that:

1. Is compatible with ALUCP noise and safety compatibility policies, and
2. Does not require FAA review²³ or is determined by the FAA not to be a hazard or obstruction to air navigation

²⁰ See Chapter 3, Safety Compatibility Policies and Standards.

²¹ See Chapter 2, Noise Compatibility Policies and Standards and Chapter 3, Safety Compatibility Policies and Standards.

²² See Chapter 4, Airspace Protection Policies and Standards.

²³ Title 14, Code of Federal Regulations, Part 77, *Safe, Efficient Use, and Preservation of the Navigable Airspace*, Subpart B, *Notice Requirements*, §77.9.

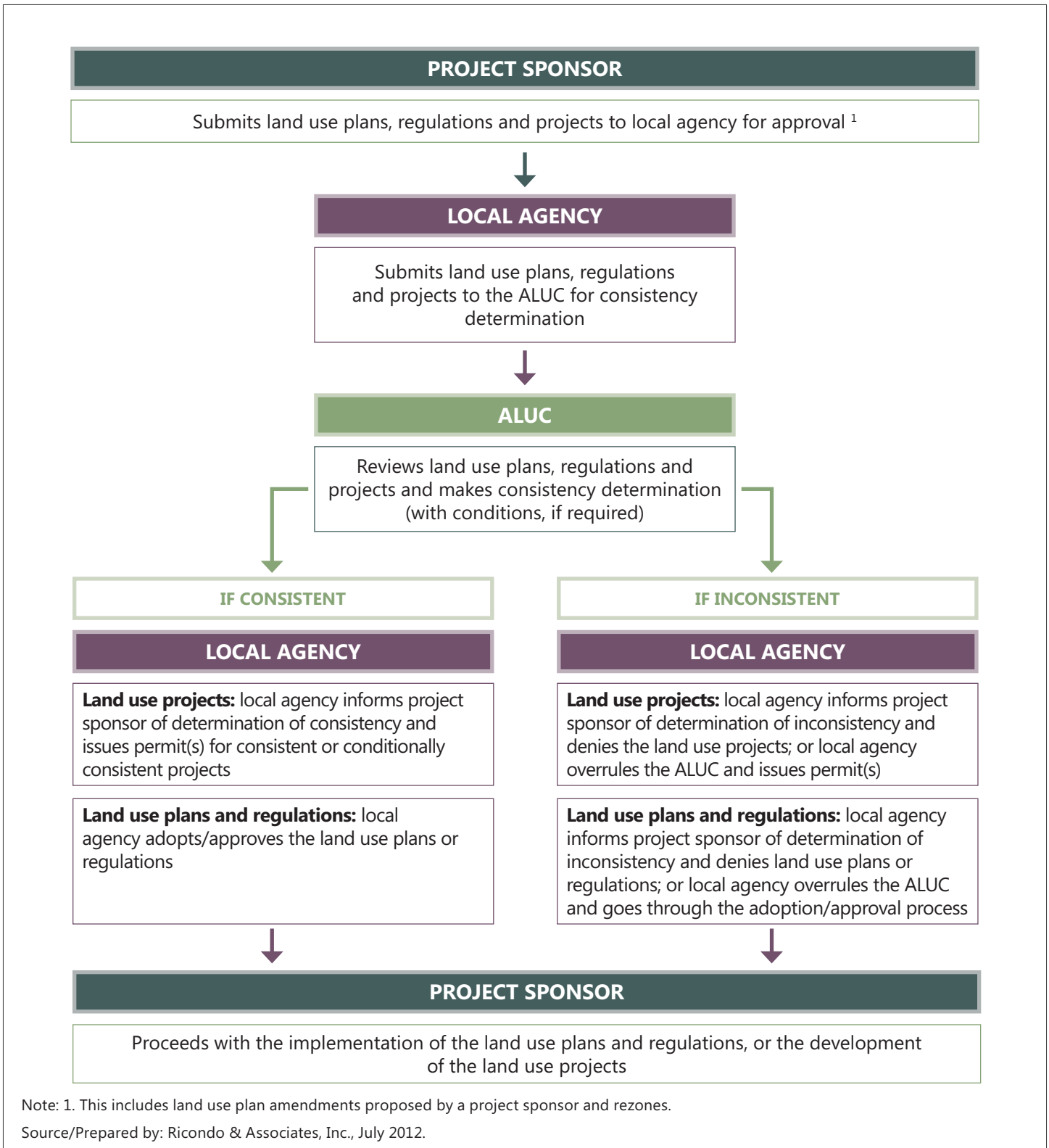

Exhibit 1-2

ALUC Review Before Local Agency Implementation

1.9.2 Review Area 2

ALUC review is required for land use plans and regulations within Review Area 2 proposing increases in height limits and for land use projects that:

- Have received from the FAA a Notice of Presumed Hazard, a Determination of Hazard or a Determination of No Hazard subject to conditions, limitations or marking and lighting requirements,²⁴ and/or
- Would create any of the following hazards, as discussed in **Section 4.4** in **Chapter 4**:
 - Glare
 - Lighting
 - Electromagnetic interference
 - Dust, water vapor, and smoke
 - Thermal plumes
 - Bird attractants

1.9.3 Consistency Determination Review Process

Local agencies must submit an application for consistency determination to the ALUC for proposed land use plans, regulations and projects as required by this ALUCP.²⁵

The application must contain information described in **Appendix B**. The procedures discussed in the following sections apply

1.9.3.1 Review of Application for Completeness

ALUC staff must determine if the application for consistency determination from the local agency is complete and notify the local agency of application completeness in writing within 30 calendar days after receipt of an application.

If the application for consistency determination is incomplete, ALUC staff will identify the information required to complete the application and inform the local agency. If additional information is required, a new 30-calendar day review period begins after the additional information is received by ALUC staff.

If ALUC staff does not make a written determination of completeness within 30 calendar days after receipt of an application for consistency determination, the application is considered complete.

²⁴ Title 14, Code of Federal Regulations, Part 77, *Safe, Efficient Use, and Preservation of the Navigable Airspace*, Subpart D, *Aeronautical Studies and Determinations*, §§77.25 – 77.35.

²⁵ California Public Utilities Code §21676

1.9.3.2 Consistency Review Timeframe

The ALUC must respond to a local agency's request for consistency determination within 60 calendar days after the application is deemed complete by ALUC staff.

The 60 calendar day review period may be extended if the local agency agrees in writing or so states at an ALUC meeting.

If the ALUC fails to act within 60 calendar days, the proposed land use plan, regulation or project is considered consistent with this ALUCP.²⁶

1.9.3.3 Consistency Determination Result

The ALUC must notify the local agency in writing of its consistency determination. A proposed land use plan, regulation or project is determined to be one of the following:

1. Consistent with all four compatibility factors in this ALUCP. The local agency can proceed with its approval.
2. Conditionally consistent with this ALUCP. Any specified conditions must correspond to the policies and standards of this ALUCP. Unless a condition specifies subsequent review by the ALUC, responsibility to ensure compliance with conditions rests with the local agency with permit or approval authority.
3. Not consistent with this ALUCP. The ALUC must explain the specific conflicts with ALUCP policies and standards. The local agency may not approve the proposed land use plan, regulation or project, unless it overrules the ALUC's finding of inconsistency in accordance with applicable State law.²⁷

Exhibit 1-3 presents a flow diagram summarizing the consistency determination review process.

1.10 Local Agency Implementation

1.10.1 Local Agency Requirements and Responsibilities

Within 180 calendar days of the ALUC's adoption or amendment of this ALUCP, each local agency affected by this ALUCP must:²⁸

1. Amend its land use plans and regulations to be consistent with this ALUCP, or
2. Overrule this ALUCP by a two-thirds vote of its governing body after adopting findings that justify the overrule and providing notice, as required by law²⁹

If a local agency fails to take either action, it must follow the review process detailed in **Section 1.9**.

²⁶ California Public Utilities Code §21676(d).

²⁷ California Public Utilities Code §21675.1(d).

²⁸ California Government Code §65302.3(a), (b) and (c).

²⁹ California Public Utilities Code §21675.1(d).

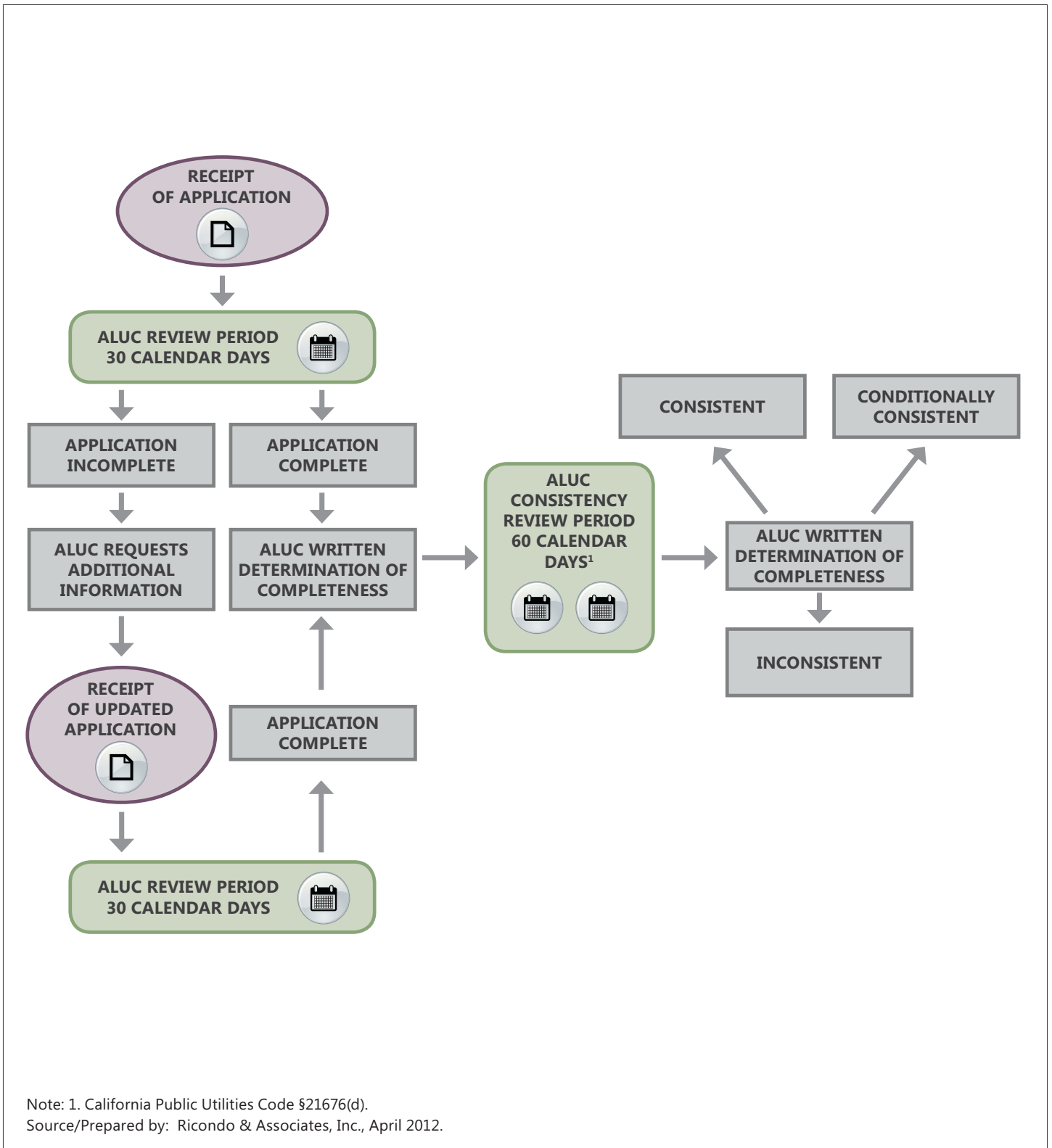

Exhibit 1-3

Consistency Determination Review Process

1.10.2 Establishing Consistency of Local Agency Land Use Plans and Regulations

To establish consistency of land use plans and regulations with this ALUCP, local agencies must eliminate conflicts with this ALUCP. Conflicts may include:

- Land use plan or zoning designations that permit incompatible uses within noise contours or safety zones
- Permissible residential densities and nonresidential intensities that exceed this ALUCP's density and intensity limits in any safety zone
- Permissible heights that would either constitute a hazard as determined by the FAA or penetrate the TSSs

Land use designations in local agency land use plans that reflect existing land uses do not render the local agency plans inconsistent with this ALUCP. However, local agencies must limit the expansion and reconstruction of existing land uses that are not consistent with this ALUCP in accordance with the existing incompatible land use policies and standards of this ALUCP (see **Section 1.6**).

1.10.2.1 Methods of Implementing this ALUCP

A local agency can make its land use plans and regulations consistent with this ALUCP in the following ways:

- Incorporate ALUCP policies into General Plan Elements—Individual elements of local general plans may be amended to incorporate applicable policies from this ALUCP. For example, noise compatibility policies and standards could be added to the noise element, safety policies to the safety element, and other policies, standards and maps to the land use element
- Adopt ALUCP as Stand-Alone Document—Local agencies may adopt this ALUCP as a local policy document
- Adopt Overlay Zone—Local agencies may incorporate the policies and standards of this ALUCP into an overlay zone to supplement the requirements of the standard land use zoning districts

What is an Overlay Zone?

An overlay zone is a special purpose zoning district. The regulations within an overlay zone supplement the requirements of the underlying standard zoning districts (typically residential, commercial, or industrial). Overlay zones are used to achieve a special purpose, such as flood hazard protection or the preservation of a historic district, without directly changing the underlying land use in the affected area.

1.10.2.2 Ensuring Long-Term Compliance with this ALUCP

Local agency land use plans and regulations must include provisions for long-term compliance with this ALUCP. Local agencies must define the process they will follow when revising or amending land use plans and regulations, or when reviewing and approving land use projects within the AIA to ensure that they will be consistent with this ALUCP. Land use plans and regulations, including zoning, subdivision and building regulations, must include standards for reviewing land use projects for consistency with this ALUCP. More information regarding implementation can be found in **Appendix B**.

1.11 ALUC Review after Local Agency Implementation

Exhibits 1-4 and **1-5** depict the ALUC review process of land use plans, regulations and projects after a local agency has implemented this ALUCP.

1.11.1 Review of Land Use Plans and Regulations

Proposed land use plans and regulations within Review Area 1 always require ALUC review. ALUC review is also required for land use plans and regulations within Review Area 2 proposing increases in height limits.

1.11.2 Review of Land Use Projects

After local agency implementation or overrule of this ALUCP, land use projects are no longer required to be submitted to the ALUC for review, unless the following apply:

- The land use project includes a land use plan amendment or rezone
- The land use project has received a determination from the FAA that it will constitute a hazard or obstruction to air navigation
- The land use project has characteristics that may result in the creation of a hazard to air navigation, as discussed in **Sections 4.4 and 4.5** in **Chapter 4**

1.11.3 Voluntary Review of Land Use Projects

After implementation, local agencies may choose to submit land use projects to the ALUC for advisory review. Any ALUC recommendation would be non-binding.

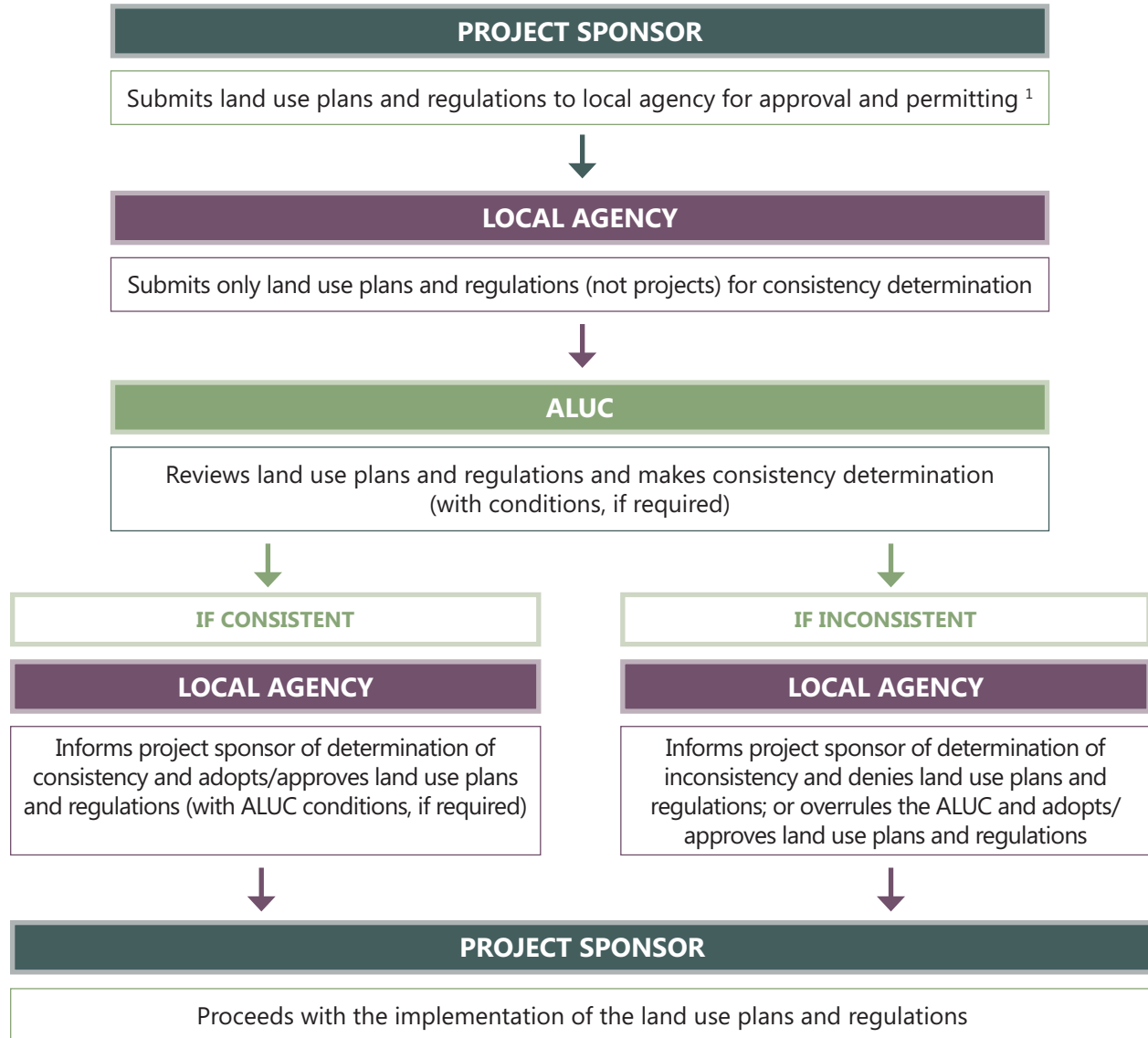

Note: 1. This includes land use plan amendments proposed by a project sponsor and rezones.

Source/Prepared by: Ricondo & Associates, Inc., July 2012.



Exhibit 1-4

ALUC Review After Local Agency Implementation Land Use Plans and Regulations

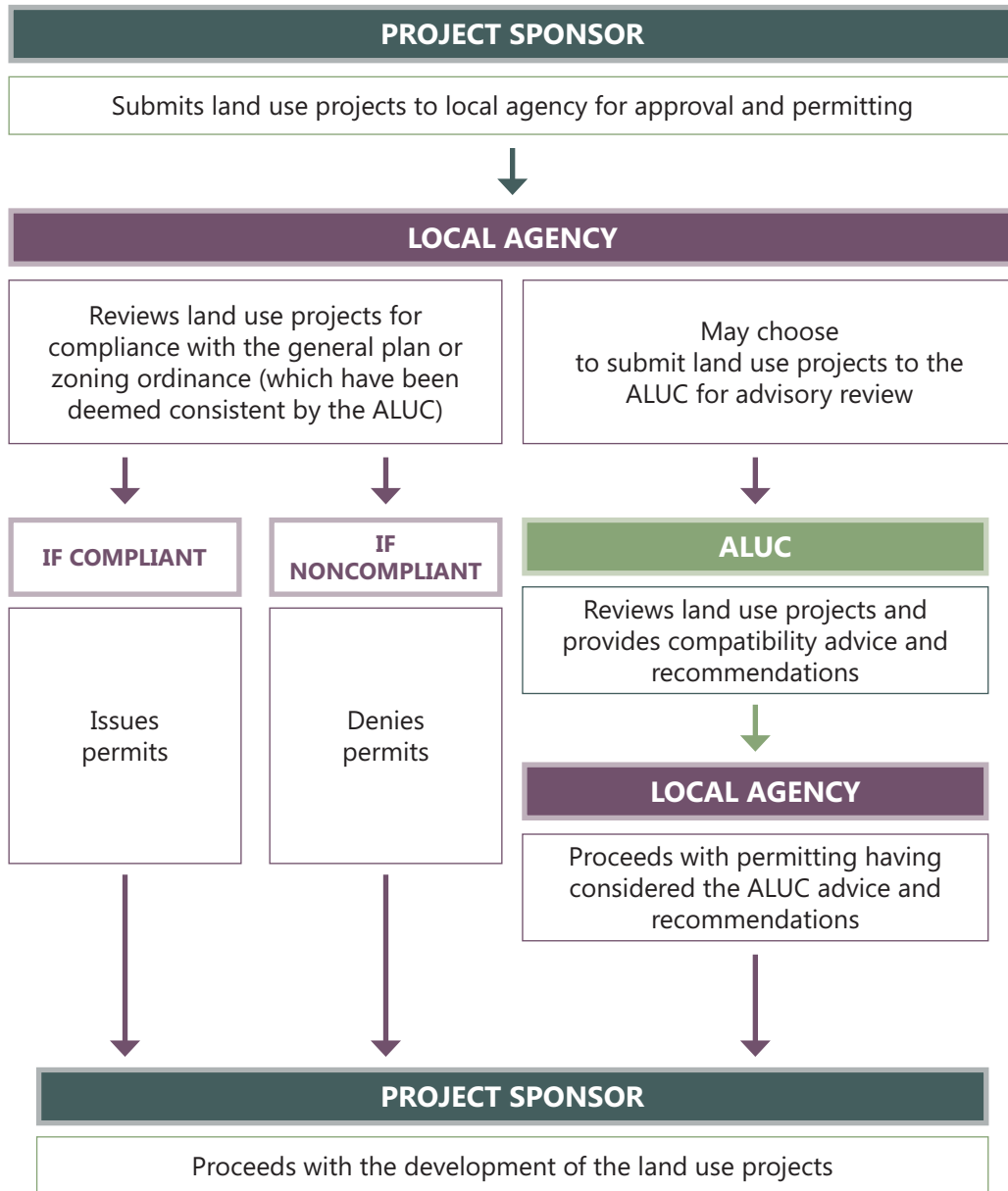

Source/Prepared by: Ricondo & Associates, Inc., July 2012.



Exhibit 1-5

**ALUC Review After Local Agency Implementation
Land Use Projects**

1.11.4 Consistency Determination Review Process

Local agencies must submit to the ALUC an application for consistency determination for proposed land use plans and regulations as required by this ALUCP.³⁰ The consistency determination review process for land use plans and regulations follows the same process as discussed in **Section 1.9.3**.

1.12 ALUC Review of Proposed Airport Plans and Projects

The ALUC is required by State law to review proposed airport plans for consistency with this ALUCP.³¹ This requirement ensures that the ALUC is kept informed of changes in airport plans so that appropriate amendments to this ALUCP can be made.

1.12.1 Airport Plans and Projects

The following airport plans and projects require ALUC review:³²

- Any airport master plan, amendments to an airport master plan, or airport layout plan that would modify previously adopted airport plans
- Any proposal for airport expansion if it requires an amended Airport Permit from the State of California.³³ Airport expansion is defined to include the construction of a new runway, the extension or realignment of an existing runway, the acquisition of runway protection zones or the acquisition of any interest in land for the purposes identified above.
- Land use projects involving development of airport property for nonaviation uses

1.12.2 ALUC Actions on Airport Plans

The ALUC must determine if an airport master plan, airport layout plan, or expansion plan is consistent or inconsistent with this ALUCP. When an inconsistency exists, the ALUC will amend this ALUCP to reflect the assumptions and proposals in the airport plans.³⁴

1.12.3 Consistency Determination Result

A proposed plan or project is determined to be one of the following:

- Consistent: the airport operator can proceed with the plan or project
- Inconsistent: the ALUC must amend this ALUCP³⁵

³⁰ California Public Utilities Code § 21676(b).

³¹ California Public Utilities Code §21676(c).

³² California Public Utilities Code §21676(c); California Department of Transportation, Division of Aeronautics, *California Airport Land Use Planning Handbook*, October 2011, pp. 6-3 – 6-4.

³³ California Public Utilities Code §21664.5.

³⁴ California Public Utilities Code §21675(a).

³⁵ California Public Utilities Code §21675(a).

Non-aviation uses are determined to be one of the following:

- Consistent: the airport operator can proceed with the plan or project
- Conditionally consistent: the airport operator can proceed with the plan or project with conditions as per the policies and standards of this ALUCP
- Inconsistent: the ALUC must identify the specific conflicts with ALUCP policies and standards

1.12.4 Limit of ALUC Authority Over Airport

SDCRAA, serving in its capacity as the ALUC, has no authority over airport operations.³⁶

³⁶ California Public Utilities Code §21674(e).



CHAPTER 2

Noise Compatibility Policies and Standards

Chapter 2 provides the noise contour map for San Diego International Airport (SDIA or the Airport) upon which noise compatibility policies and standards are based.

Appendix E2 provides the technical basis for delineating the noise contours and establishing the policies and standards.

In addition to the policies and standards established by this chapter, a project sponsor must also review all policies and standards established by this ALUCP.

The policies of this chapter apply only to new development or redevelopment. The policies do not apply to existing land uses, except as noted in **Section 1.6** in **Chapter 1**.

A list of the noise compatibility policies is provided below.



<u>Policy N.1</u>	Noise Contour Map and Table
<u>Policy N.2</u>	Sound Attenuation
<u>Policy N.3</u>	Evaluation of Noise Compatibility for Development with a Mix of Uses
<u>Policy N.4</u>	Residential Land Use within 70 dB CNEL Contour and Greater
<u>Policy N.5</u>	Building Split by a Noise Contour
<u>Policy N.6</u>	Land Uses Not Specified in Table 2-1
<u>Policy N.7</u>	New Uses in Existing Buildings
<u>Policy N.8</u>	Avigation Easement Dedication

Noise Compatibility Policies and Standards

Policy N.1 Noise Contour Map and Table

This ALUCP establishes the 60 dB CNEL contour as the threshold above which noise compatibility standards apply.¹ Noise contours by 5 dB CNEL increments are depicted in **Exhibit 2-1**.

Proposed land uses will be evaluated for consistency with the standards contained in **Table 2-1**. These standards establish three land use compatibility categories, as follows:

-  Compatible (green): The use is consistent with this ALUCP.
-  Conditionally compatible (yellow): The use is consistent with this ALUCP if the conditions described in **Table 2-1** are met.
-  Incompatible (red): The use is inconsistent with this ALUCP.

Land uses located outside the 60 dB CNEL contour are not subject to the noise compatibility policies and standards of this ALUCP.

Policy N.2 Sound Attenuation

Conditionally compatible land uses must incorporate sound attenuation to achieve indoor noise levels as specified in **Table 2-1**.

Policy N.3 Evaluation of Noise Compatibility for Development with a Mix of Uses

When a land use project involves a combination of different land uses listed in **Table 2-1**, each component use must comply with the applicable noise standards.

Policy N.4 Residential Land Use within 70 dB CNEL Contour and Greater

As depicted on **Exhibit 2-2**, new residential development is allowed at or above the 70 dB CNEL contour only if the affected property is currently designated to allow for residential use in the applicable general or community plan and it complies with the conditions described in **Table 2-1**.

In areas exposed to airport noise at or above 70 dB CNEL, general and community plan amendments from nonresidential to residential designations are not allowed.

¹ California Department of Transportation, Division of Aeronautics, *California Airport Land Use Planning Handbook*, October 2011, p. 4-46.

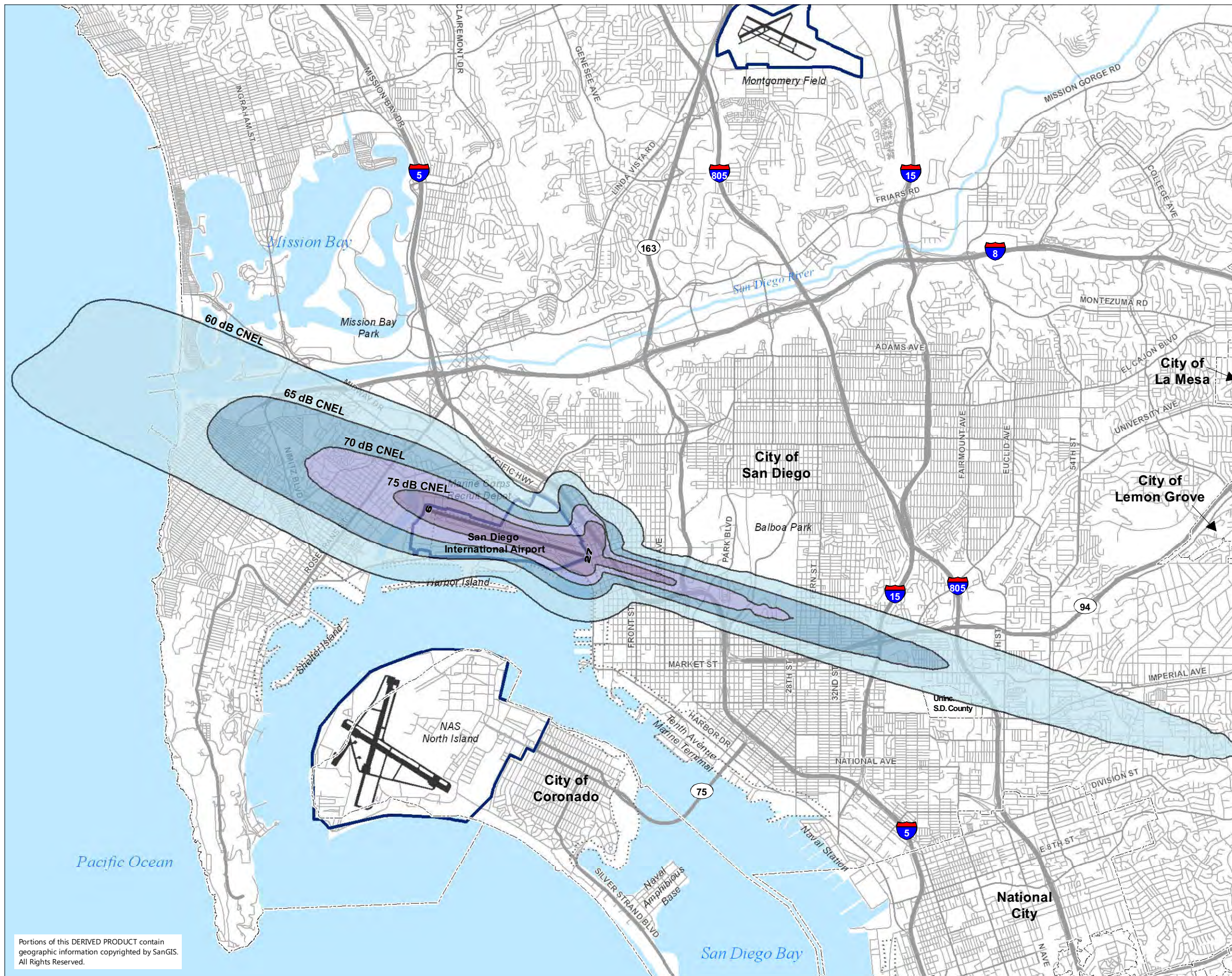

LEGEND

- Major Roads
- Highways
- - - Municipal Boundaries
- ▭ Airport Property Boundary
- ▭ San Diego Unified Port District
- ▭ Planning Jurisdiction Boundary

Forecast Noise Exposure Ranges:

- ▭ 60 - 65 dB CNEL
- ▭ 65 - 70 dB CNEL
- ▭ 70 - 75 dB CNEL
- ▭ 75 + dB CNEL



Notes: 1. CNEL = Community Noise Equivalent Level
 2. Based on 2030 Forecast Noise Exposure.

Sources: San Diego Geographic Information Source (SanGIS), 2008 and 2011 (municipal boundaries, roads and highways); Harris Miller Miller & Hanson Inc., 2010 (forecast noise exposure ranges).

Prepared by: Ricondo & Associates, Inc., July 2012.

**Exhibit 2-1
 Noise Contour Map**

Portions of this DERIVED PRODUCT contain geographic information copyrighted by SanGIS. All Rights Reserved.

Table 2-1 Noise Compatibility Standards

Land Use Category ^a	Noise Contour Range (dB CNEL)			
	60-65	65-70	70-75	75 +
RESIDENTIAL				
Single-Family, Multi-family	45	45 ¹	45 ^{1,2}	45 ^{1,2}
Single Room Occupancy (SRO) Facility	45	45 ¹	45 ^{1,2}	45 ^{1,2}
Group Quarters ^b	45	45 ¹	45 ^{1,2}	45 ^{1,2}
COMMERCIAL, OFFICE, SERVICE, TRANSIENT LODGING				
Hotel, Motel, Resort	45/50	45/50	45/50	45/50
Office - Medical, Financial, Professional Services, Civic			50	50
Retail (e.g., Convenience Market, Drug Store, Pet Store)			50	50
Service - Low Intensity (e.g., Gas Station, Auto Repair, Car Wash)			50	50
Service - Medium Intensity (e.g., Check-cashing, Veterinary Clinics, Kennels, Personal Services)			50	50
Service - High Intensity (e.g., Eating, Drinking Establishment, Funeral Chapel, Mortuary)			50	50
Sport/Fitness Facility			50	50
Theater - Movie/Live Performance/Dinner		45	45	45
EDUCATIONAL, INSTITUTIONAL, PUBLIC SERVICES				
Assembly - Adult (Religious, Fraternal, Other)	45	45 ¹	45 ¹	45 ¹
Assembly - Children (Instructional Studios, Cultural Heritage Schools, Religious, Other) ³	45			
Cemetery				
Child Day Care Center/Pre-K	45			
Convention Center				
Fire and Police Stations			50	50
Jail, Prison		45/50	45/50	45/50
Library, Museum, Gallery		45	45	45
Medical Care - Congregate Care Facility, Nursing and Convalescent Home ^b	45			
Medical Care - Hospital	45			
Medical Care - Out-Patient Surgery Centers	45			
School for Adults – College, University, Vocational/Trade School	45	45 ¹	45 ¹	
School – Kindergarten through Grade 12 <u>(Includes Charter Schools)</u>	45			
INDUSTRIAL				
Junkyard, Dump, Recycling Center, Construction Yard				
Manufacturing/Processing - General				
Manufacturing/Processing of Biomedical Agents, Biosafety Levels 3 and 4 Only				
Manufacturing/Processing of Hazardous Materials ⁴				
Mining, Extractive Industry				
Research and Development - Scientific, Technical				
Sanitary Landfill				
Self-storage Facility				
Warehousing/Storage - General				
Warehousing/Storage of Biomedical Agents, Biosafety Levels 3 and 4 Only				
Warehousing/Storage of Hazardous Materials ⁴				

Land Use Category ^a	Noise Contour Range (dB CNEL)			
	60-65	65-70	70-75	75 +
TRANSPORTATION, COMMUNICATION, UTILITIES				
Auto Parking				
Electrical Power Generation Plant				
Electrical Substation				
Emergency Communications Facilities				
Marine Cargo Terminal				
Marine Passenger Terminal				
Transit Center, Bus/Rail Station				
Transportation, Communication, Utilities - General				
Truck Terminal				
Water, Wastewater Treatment Plant				
RECREATION, PARK, OPEN SPACE				
Arena, Stadium				
Golf Course				
Golf Course Clubhouse				
Marina				
Park, Open Space, Recreation				
AGRICULTURE				
Aquaculture				
Agriculture				
LEGEND				
	Compatible: Use is permitted.			
	Conditionally Compatible: Use is permitted subject to stated conditions.			
	Incompatible: Use is not permitted under any circumstances.			
45	Indoor uses: building must be capable of attenuating exterior noise to 45 dB CNEL.			
50	Indoor uses: building must be capable of attenuating exterior noise to 50 dB CNEL.			
45/50	Sleeping rooms must be attenuated to 45 dB CNEL and any other indoor areas must be attenuated to 50 dB CNEL.			
1	Avigation easement must be dedicated to the Airport owner/operator.			
2	New residential use is permitted above the 70 dB CNEL contour only if the current General/Community Plan designation allows for residential use. General/Community Plan amendments from a nonresidential designation to a residential designation are not permitted.			
3	Refer to Appendix A for definition of Assembly - Children.			
4	Refer to Appendix A for definitions of manufacturing, processing and storage of hazardous materials.			
a	Land uses not specifically listed shall be evaluated, as determined by the ALUC, using the criteria for similar uses. Refer to Appendix A.			
b	If this land use would occur within a single- or multi-family residence, it must be evaluated using the criteria for single- or multi-family residential.			

Source: Ricondo & Associates, Inc., ~~July 2013~~ January 2014.

Prepared by: Ricondo & Associates, Inc., ~~July 2013~~ January 2014.

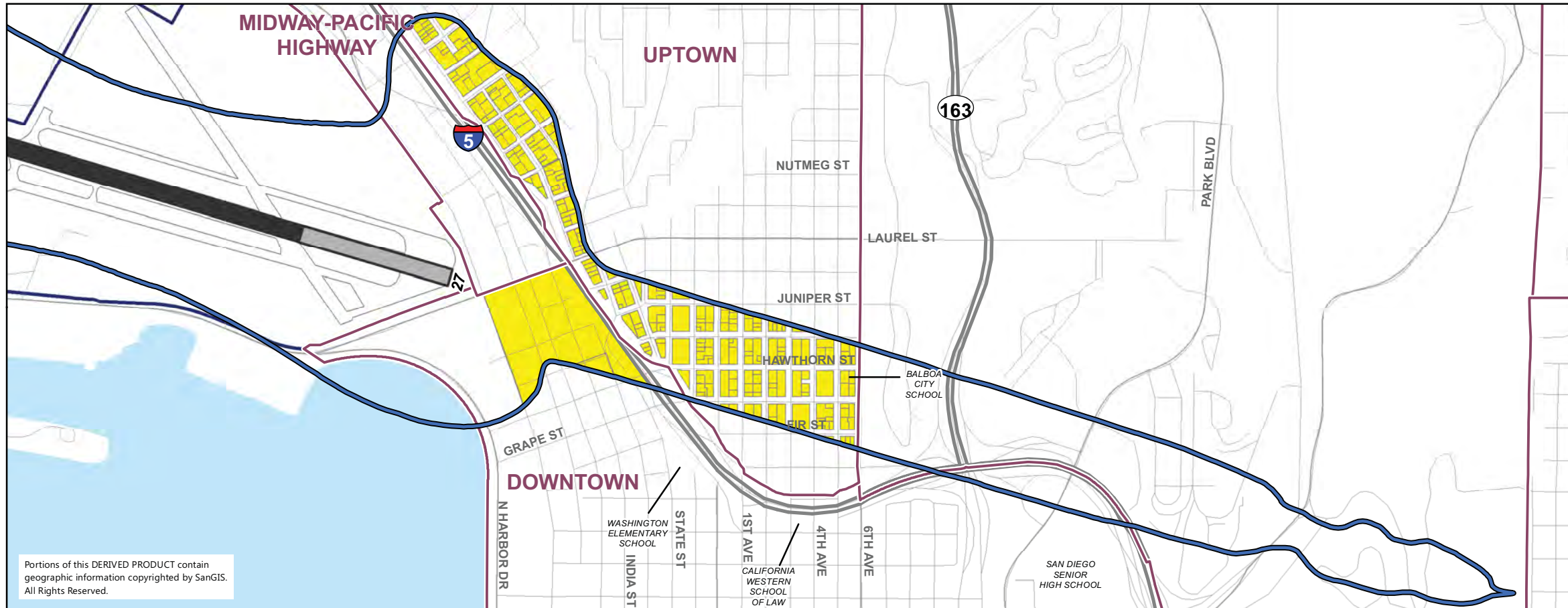
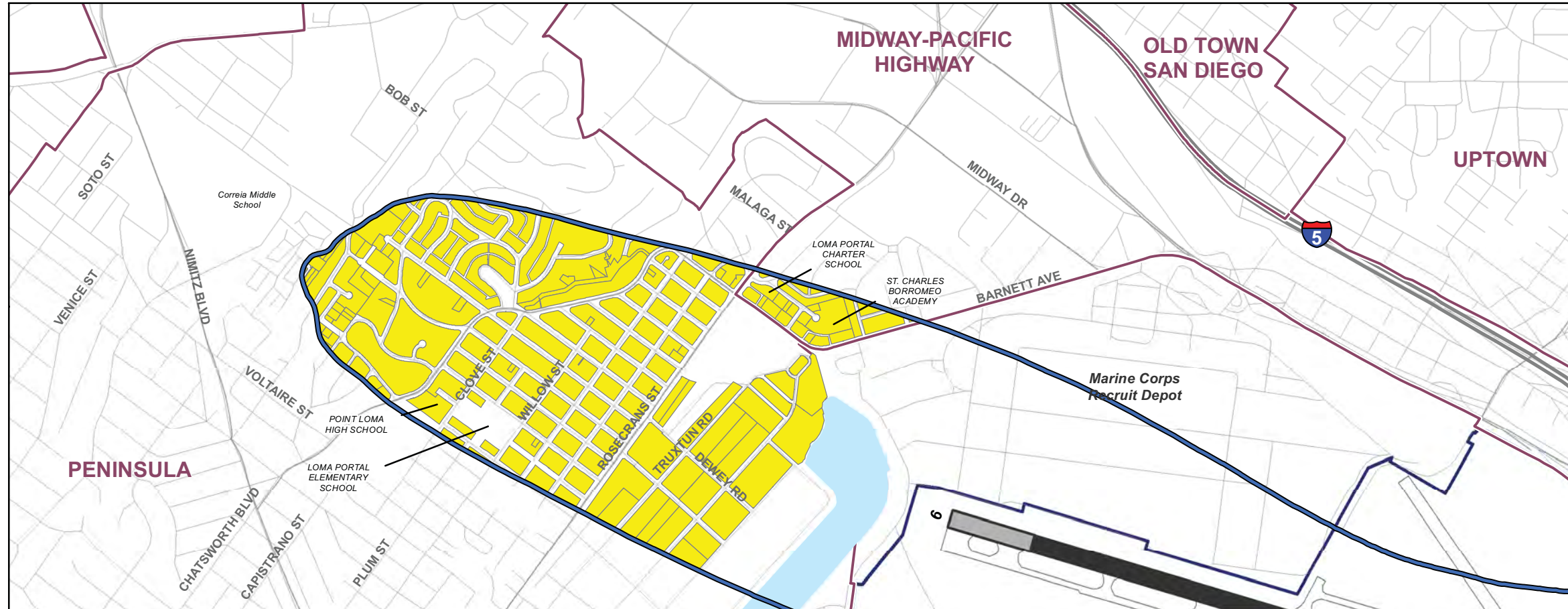

LEGEND

- Major Roads
 - Highways
 - Community Planning Areas
 - Airport Property Boundary
 - Displaced Thresholds
 - 70 dB CNEL Noise Contour¹
- General/Community Plan Land Use**
- Residential Use Allowed²



Notes:

1. CNEL = Community Noise Equivalent Level
2. The general plan and community plans allow residential use in areas designated for mixed-use as well as residential use. Residential use is also allowed in some areas designated for commercial use. The remaining parcels, within the 70 dB CNEL contour (not shaded in yellow), are designated in the general and community plans for uses other than residential.

Sources: San Diego Geographic Information Source (SanGIS) updated in 2011 (roads and highways); City of San Diego, August 2011 (neighborhood boundaries); Ricondo & Associates, Inc., February 2011, based on information received from the City of San Diego Development Services Planning Division (general plan land use designation GIS data for Peninsula, Midway-Pacific Highway, Old Town San Diego, Uptown, Centre City and Greater Golden Hill community planning areas).

Prepared by: Ricondo & Associates, Inc., December 2013.

**Exhibit 2-2
Residential Use Allowed under the
General/Community Plans
Above 70 dB CNEL**

Portions of this DERIVED PRODUCT contain geographic information copyrighted by SanGIS. All Rights Reserved.

Exhibit 2-2 depicts parcels located within the 70 dB CNEL contour where residential use is allowed under the current general or community plans. These parcels are shaded in yellow on **Exhibit 2-2**. The general and community plans allow residential use in areas designated for mixed-use as well as residential use. The remaining parcels (not shaded in yellow), within the 70 dB CNEL contour, are designated in the general and community plans for uses other than residential. Under this policy, nonresidential plan designations within the 70 dB CNEL contour cannot be changed to designations that would allow residential use.

Policy N.5 Building Split by a Noise Contour

The standards for the noise contour range within which **more than 50 percent** of the building is located, as determined by gross floor area (in square feet), apply.



For Illustrative Purposes Only

Policy N.6 Land Uses Not Specified in Table 2-1

For any proposed land use that is not specified in **Table 2-1**, the ALUC must determine the most similar land use based upon the land use definitions and guidance in **Appendix A**. The ALUC may also consider the noise sensitivity of the land use in determining the most similar land use. Considerations include whether the land use involves:

- Sleeping rooms
- Activities where a quiet indoor environment is needed

Once the ALUC determines the most similar land use, standards for that land use will apply.

Policy N.7 New Uses in Existing Buildings

No consistency review is required when new compatible or conditionally compatible uses, as described in **Table 2-1**, are proposed within a portion of an existing building, such as a multi-tenant shopping center. However, consistency review is required for new residential, public assembly and

adult school uses.² Incompatible uses are not allowed.

Consistency review, including recordation of an avigation easement (if applicable), is required when a new use (or multiple uses) is proposed to entirely occupy an existing building. Only new residential, public assembly and adult school uses require sound attenuation per **Table 2-1**.

Policy N.8 Avigation Easement Dedication

Conditionally compatible land uses located within the 65 dB CNEL (and higher) noise contour that require an avigation easement per **Table 2-1** shall dedicate an avigation easement to the owner or operator of the Airport that includes the following provisions:

1. Provide the right of flight in the airspace above the property
2. Allow the generation of noise and other impacts associated with the legal operation of aircraft over the property

See **Appendix B** for the SDIA avigation easement template.

What is an Avigation Easement?

*An easement is a legal document that gives one entity the right to use a part of the real estate owned by another entity, but only as specified in the easement document. An avigation easement is a particular form of easement that may convey, for example, the right of passage over the property and the right to cause associated impacts including noise. See **Appendix B** for the SDIA avigation easement template.*

² Title 21, California Code of Regulations, Subchapter 6, *Noise Standards*, Section 5014.



CHAPTER 3

Safety Compatibility Policies and Standards

Chapter 3 provides a map of the safety zones for San Diego International Airport (SDIA or the Airport) and applicable policies and standards.

Appendix E3 provides the technical basis for delineating the safety zones and establishing the safety compatibility policies and standards.

In addition to the policies and standards established by this chapter, a project sponsor must also review all policies and standards established by this ALUCP.

The policies of this chapter apply only to new development or redevelopment. The policies do not apply to existing land uses, except as noted in **Section 1.6** in **Chapter 1**. A list of the safety compatibility policies is provided below.

<u>Policy S.1</u>	Safety Compatibility Zone Map and Table
<u>Policy S.2</u>	Uses Allowed in Safety Zone 1
<u>Policy S.3</u>	Maximum Densities Include Density Bonuses
<u>Policy S.4</u>	Maximum Densities Exclude Second Dwelling Units
<u>Policy S.5</u>	Residential Land Use Designations
<u>Policy S.6</u>	Nonresidential Projects with a Single Use
<u>Policy S.7</u>	Nonresidential Projects with Multiple Uses
<u>Policy S.8</u>	Mixed-Use Projects
<u>Policy S.9</u>	Ancillary Uses
<u>Policy S.10</u>	Buildings Split by Safety Zone Boundaries
<u>Policy S.11</u>	Land Uses Not Specified in Table 3-1
<u>Policy S.12</u>	New Uses in Existing Buildings

The safety compatibility standards of this ALUCP provide maximum residential density and nonresidential intensity limits that are allowable within the safety zones.

What is Residential Density?	What is Nonresidential Intensity?
Density is a measure of the concentration of people in residential land uses and is expressed by the number of dwelling units per acre.	Intensity is a measure of the concentration of people in nonresidential land uses and is expressed by the number of people per acre.

Safety Compatibility Policies and Standards

Policy S.1 Safety Compatibility Zone Map and Table

This ALUCP establishes the safety zones where safety policies and standards apply, as depicted in **Exhibit 3-1**.¹

Table 3-1 establishes the safety compatibility standards that apply to different land use categories within each safety zone. Land uses are classified within each safety zone as:

- Compatible (green): The use is consistent with this ALUCP (no density or intensity limits apply).
- Conditionally compatible (yellow): The use is consistent with this ALUCP if the conditions described in **Table 3-1** are met. For residential uses, the maximum allowable density is indicated for each Community Planning Area (CPA)/neighborhood by safety zone. Residential density is measured as the number dwelling units per net acre. For nonresidential uses, the maximum allowable intensity is indicated for each CPA/neighborhood by safety zone. Nonresidential intensity is measured as the number of people per net acre.
- Incompatible (red): The use is inconsistent with this ALUCP.

¹ See Appendix E of this ALUCP for a detailed explanation of the safety zone adjustments made to reflect operations at SDIA.

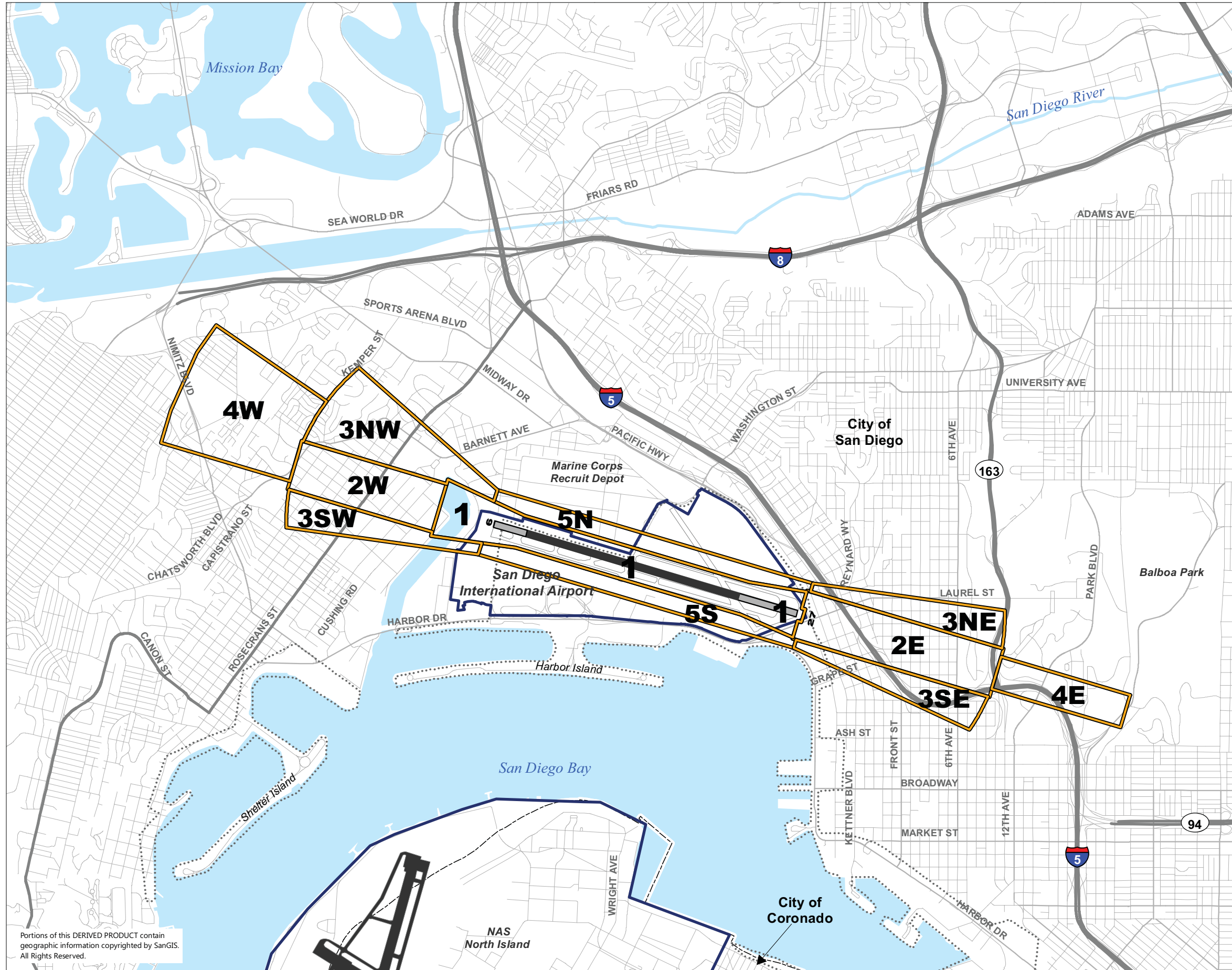

LEGEND

- Major Roads
- Highways
- - - Municipal Boundaries
- ▬ Displaced Thresholds
- ▭ Airport Property Boundary
- ▭ Safety Compatibility Zone
- ⋯ San Diego Unified Port District Planning Jurisdiction Boundary



Note: The outer boundary of the Safety Zone 1 East (Runway 27 Runway Protection Zone (RPZ)) is adjusted to reflect the portion of the Runway Obstacle Free Zone (OFZ) that extends beyond the RPZ.

Sources: San Diego Geographic Information Source (SanGIS), 2008 and 2011 (municipal boundaries, roads and highways); Ricondo & Associates, Inc., January 2012, based on GIS datasets received from the City of San Diego, SanGIS and San Diego Association of Governments (SANDAG) (GIS datasets were updated based on surveys conducted in July and November 2011; safety compatibility zones).

Prepared by: Ricondo & Associates, Inc., December 2013.

Portions of this DERIVED PRODUCT contain geographic information copyrighted by SanGIS. All Rights Reserved.

Exhibit 3-1 Safety Compatibility Zones

Table 3-1 Safety Compatibility Standards

Community Planning Area - Neighborhood	Density/Intensity for Conditional Uses																				
	Safety Zones																				
	2E		2W		3NE		3SE		3NW		3SW		4E		4W		5N		5S		
	R	NR	R	NR	R	NR	R	NR	R	NR	R	NR	R	NR	R	NR	R	NR	R	NR	
Balboa Park	±	96													±	240					
Centre City - Cortez	±	96					210	842							±	240					
Centre City - East Village															±	240					
Centre City - Little Italy	40	255					154	732												±	180
Midway - Pacific Highway	46	191			±	180			44	198									±	180	
Ocean Beach																31	240				
Peninsula - NTC			±	127					±	180	±	235									
Peninsula - Other Neighborhoods			20	96					10	180	9	180			36	240					
Uptown	58	272			62	278	164	674													
Persons per household for mixed-use projects ^a		1.51		2.35		1.48		1.57		2.27		2.23		1.52		2.14		n/a		n/a	
R	Maximum allowable residential density, in dwelling units per acre.																				
NR	Maximum allowable nonresidential intensity, in people per acre.																				
±	No dwellings are in the part of the CPA or neighborhood within the indicated Safety Zone. No new dwellings are permitted in this area unless the parcel was designated for residential use in the community plan as of the effective date of this ALUCP.																				
	No part of the Community Planning Area or neighborhood is in the Safety Zone.																				

Land Use Category ^b	Safety Zones					Conditions	Occupancy Factor ¹
	1	2	3	4	5		
RESIDENTIAL							
Single-Family, Multi-family						Zones 2, 3, 4: Allow in areas designated for residential use in the applicable Community Plan, subject to the dwelling unit density limits shown above.	N/A
Single Room Occupancy (SRO) Facility ²						Zones 2, 3, 4: Allow if development intensity does not exceed the NR limits shown above.	200
Group Quarters ^{2,c}						Zones 3, 4: Allow if development intensity does not exceed the NR limits shown above.	100
COMMERCIAL, OFFICE, SERVICE, TRANSIENT LODGING							
Hotel, Motel, Resort						Zone 2: Allow if no more than 56 rooms per acre and no conference facilities. <u>No other use allowed unless it qualifies as ancillary per Policy S.9.</u> Zones 3, 4: Allow if development intensity does not exceed the NR limits.	N/A 200
Office - Medical, Financial, Professional Services, Civic						Zones 2, 3, 4, 5: Allow if development intensity does not exceed the NR limits shown above.	215
Retail (e.g., Convenience Market, Drug Store, Pet Store)						Zones 2, 3, 4, 5: Allow if development intensity does not exceed the NR limits shown above.	170
Service - Low Intensity (e.g., Gas Station, Auto Repair, Car Wash)						Zones 2, 3, 4, 5: Allow if development intensity does not exceed the NR limits shown above.	250
Service - Medium Intensity (e.g., Check-cashing, Veterinary Clinics, Kennels, Personal Services)						Zones 2, 3, 4, 5: Allow if development intensity does not exceed the NR limits shown above.	200
Service - High Intensity (e.g., Eating, Drinking Establishment, Funeral Chapel, Mortuary)						Zones 2, 3, 4, 5: Allow if development intensity does not exceed the NR limits shown above.	60
Sport/Fitness Facility						Zones 3, 4: Allow if development intensity does not exceed the NR limits shown above.	60
Theater - Movie/Live Performance/Dinner						Zones 2, 3, 4: Allow if development intensity does not exceed the NR limits shown above.	60

Community Planning Area - Neighborhood	Density/Intensity for Conditional Uses																			
	Safety Zones																			
	2E		2W		3NE		3SE		3NW		3SW		4E		4W		5N		5S	
	R	NR	R	NR	R	NR	R	NR	R	NR	R	NR	R	NR	R	NR	R	NR	R	NR
Balboa Park	±	96											±	240						
Centre City - Cortez	±	96					210	842					±	240						
Centre City - East Village													±	240						
Centre City - Little Italy	40	255					154	732											±	180
Midway - Pacific Highway	46	191			±	180			44	198							±	180		
Ocean Beach															31	240				
Peninsula - NTC			±	127					±	180	±	235								
Peninsula - Other Neighborhoods			20	96					10	180	9	180			36	240				
Uptown	58	272			62	278	164	674												
Persons per household for mixed-use projects ^a		1.51		2.35		1.48		1.57		2.27		2.23		1.52		2.14		n/a		n/a
R	Maximum allowable residential density, in dwelling units per acre.																			
NR	Maximum allowable nonresidential intensity, in people per acre.																			
±	No dwellings are in the part of the CPA or neighborhood within the indicated Safety Zone. No new dwellings are permitted in this area unless the parcel was designated for residential use in the community plan as of the effective date of this ALUCP.																			
	No part of the Community Planning Area or neighborhood is in the Safety Zone.																			

Land Use Category ^b	Safety Zones					Conditions	Occupancy Factor ¹
	1	2	3	4	5		
EDUCATIONAL, INSTITUTIONAL, PUBLIC SERVICES							
Assembly - Adult (religious, fraternal, other)						Zone 2: Allow if capacity is less than 50 people and intensity does not exceed the NR limits shown above. Zones 3, 4: Allow if development intensity does not exceed the NR limits shown above.	60
Assembly - Children (Instructional Studios, Cultural Heritage Schools, Religious, Other) ³							N/A
Cemetery							N/A
Child Day Care Center/Pre-K							N/A
Convention Center						Zones 3, 4: Allow if development intensity does not exceed the NR limits shown above.	110
Fire and Police Stations						Zone 5: Allow only if needed to provide emergency services at Airport.	215
Jail, Prison							N/A
Library, Museum, Gallery						Zone 2: Allow if capacity is less than 50 people and intensity does not exceed the NR limits shown above. Zones 3, 4: Allow if development intensity does not exceed the NR limits shown above.	170
Medical Care - Congregate Care Facility, Nursing and Convalescent Home ^b							N/A
Medical Care - Hospital							N/A
Medical Care - Out-Patient Surgery Centers							N/A
School for Adults - College, University, Vocational/Trade School						Zones 3, 4: Allow if development intensity does not exceed the NR limits shown above.	110
School - Kindergarten through Grade 12 (Includes Charter Schools)							N/A
INDUSTRIAL							
Junkyard, Dump, Recycling Center, Construction Yard							N/A



Community Planning Area - Neighborhood	Density/Intensity for Conditional Uses																			
	Safety Zones																			
	2E		2W		3NE		3SE		3NW		3SW		4E		4W		5N		5S	
	R	NR	R	NR	R	NR	R	NR	R	NR	R	NR	R	NR	R	NR	R	NR	R	NR
Balboa Park	±	96											±	240						
Centre City - Cortez	±	96					210	842					±	240						
Centre City - East Village													±	240						
Centre City - Little Italy	40	255					154	732											±	180
Midway - Pacific Highway	46	191			±	180			44	198							±	180		
Ocean Beach														31	240					
Peninsula - NTC			±	127					±	180	±	235								
Peninsula - Other Neighborhoods			20	96					10	180	9	180			36	240				
Uptown	58	272			62	278	164	674												
Persons per household for mixed-use projects ^a		1.51		2.35		1.48		1.57		2.27		2.23		1.52		2.14		n/a		n/a
R	Maximum allowable residential density, in dwelling units per acre.																			
NR	Maximum allowable nonresidential intensity, in people per acre.																			
±	No dwellings are in the part of the CPA or neighborhood within the indicated Safety Zone. No new dwellings are permitted in this area unless the parcel was designated for residential use in the community plan as of the effective date of this ALUCP.																			
	No part of the Community Planning Area or neighborhood is in the Safety Zone.																			

Land Use Category ^b	Safety Zones					Conditions	Occupancy Factor ¹
	1	2	3	4	5		
Manufacturing/Processing - General	Red	Yellow	Yellow	Yellow	Yellow	Zones 2, 3, 4, 5: Allow if development intensity does not exceed the NR limits shown above.	300
Manufacturing/Processing of Biomedical Agents, Biosafety Levels 3 and 4 Only ⁵	Red	Red	Red	Red	Red		N/A
Manufacturing/Processing of Hazardous Materials ⁴	Red	Red	Red	Red	Yellow	Zone 5: Allow only if needed for airport/aviation-related purpose, provided that development intensity does not exceed the NR limits shown above.	300
Mining, Extractive Industry	Red	Yellow	Yellow	Yellow	Yellow	Zones 2, 3, 4, 5: Allow if development intensity does not exceed the NR limits shown above.	1000
Research and Development - Scientific, Technical	Red	Yellow	Yellow	Yellow	Yellow	Zones 2, 3, 4, 5: Allow if development intensity does not exceed the NR limits shown above.	300
Sanitary Landfill	Red	Red	Red	Red	Red		N/A
Self-storage Facility	Red	Green	Green	Green	Green		N/A
Warehousing/Storage - General	Red	Yellow	Yellow	Yellow	Yellow		1000
Warehousing/Storage of Biomedical Agents, Biosafety Levels 3 and 4 Only ⁵	Red	Red	Red	Red	Red		N/A
Warehousing/Storage of Hazardous Materials ⁴	Red	Red	Red	Red	Yellow	Zone 5: Allow only if needed for airport/aviation-related purpose, provided that development intensity does not exceed the NR limits shown above.	1000
TRANSPORTATION, COMMUNICATION, UTILITIES							
Auto Parking	Yellow	Green	Green	Green	Green	Zone 1: Structures not permitted. Allow surface lots only in "controlled activity area" outside the "central portion" of RPZ, per FAA AC 150/5300-13A, Paragraphs 310.b.(1)(a) and (b) and Figure 3-16. Dedication of avigation easement to Airport operator is required for portion of use in Zone 1.	N/A
Electrical Power Generation Plant	Red	Red	Red	Red	Red		N/A
Electrical Substation	Red	Red	Red	Red	Red		N/A
Emergency Communications Facilities	Red	Red	Red	Red	Red		N/A
Marine Cargo Terminal	Red	Green	Green	Green	Green		N/A

Community Planning Area - Neighborhood	Density/Intensity for Conditional Uses																				
	Safety Zones																				
	2E		2W		3NE		3SE		3NW		3SW		4E		4W		5N		5S		
	R	NR	R	NR	R	NR	R	NR	R	NR	R	NR	R	NR	R	NR	R	NR	R	NR	
Balboa Park	±	96											±	240							
Centre City - Cortez	±	96					210	842					±	240							
Centre City - East Village													±	240							
Centre City - Little Italy	40	255					154	732												±	180
Midway - Pacific Highway	46	191			±	180			44	198							±	180			
Ocean Beach														31	240						
Peninsula - NTC			±	127					±	180	±	235									
Peninsula - Other Neighborhoods			20	96					10	180	9	180			36	240					
Uptown	58	272			62	278	164	674													
Persons per household for mixed-use projects ^a		1.51		2.35		1.48		1.57		2.27		2.23		1.52		2.14		n/a		n/a	
R	Maximum allowable residential density, in dwelling units per acre.																				
NR	Maximum allowable nonresidential intensity, in people per acre.																				
±	No dwellings are in the part of the CPA or neighborhood within the indicated Safety Zone. No new dwellings are permitted in this area unless the parcel was designated for residential use in the community plan as of the effective date of this ALUCP.																				
	No part of the Community Planning Area or neighborhood is in the Safety Zone.																				

Land Use Category ^b	Safety Zones					Conditions	Occupancy Factor ¹
	1	2	3	4	5		
Marine Passenger Terminal						Zones 3, 4: Allow if development intensity does not exceed the NR limits shown above.	200
Transit Center, Bus/Rail Station						Zones 3, 4: Allow if development intensity does not exceed the NR limits shown above.	200
Transportation, Communication, Utilities - General						Zones 2, 3, 4, 5: Allow if development intensity does not exceed the NR limits shown above.	1000
Truck Terminal							N/A
Water, Wastewater Treatment Plant						Zones 3, 4: Allow only if no alternative sites outside the zones are available and feasible for development.	1000
RECREATION, PARK, OPEN SPACE							
Arena, Stadium							N/A
Golf Course						Zone 1: Allow only in "controlled activity area" outside the "central portion" of RPZ, per FAA AC 150/5300-13A, Paragraphs 310.b.(1)(a) and (b) and Figure 3-16. Dedication of avigation easement to Airport operator is required for portion of use in Zone 1.	N/A
Golf Course Clubhouse						Zones 2, 3, 4, 5: Allow if development intensity does not exceed the NR limits shown above.	170
Marina						Zones 3, 4, 5: Allow if development intensity does not exceed the NR limits shown above.	170
Park, Open Space, Recreation						Zone 1: Structures not allowed. Allow nonstructural uses only in "controlled activity area" outside the "central portion" of RPZ, per FAA AC 150/5300-13A, Paragraphs 310.b.(1)(a) and (b) and Figure 3-16. Dedication of avigation easement to Airport operator is required for portion of use in Zone 1.	N/A
AGRICULTURE							
Aquaculture							N/A
Agriculture						Zone 1: Allow only if it does not attract wildlife, including flocking birds, per FAA AC 150.5300-12, Sections 202.g. and 212.a.(2)(a). Dedication of avigation easement to Airport operator is required for portion of use in Zone 1.	N/A

Community Planning Area - Neighborhood	Density/Intensity for Conditional Uses																			
	Safety Zones																			
	2E		2W		3NE		3SE		3NW		3SW		4E		4W		5N		5S	
R	NR	R	NR	R	NR	R	NR	R	NR	R	NR	R	NR	R	NR	R	NR	R	NR	
Balboa Park	±	96												±	240					
Centre City - Cortez	±	96					210	842						±	240					
Centre City - East Village														±	240					
Centre City - Little Italy	40	255					154	732											±	180
Midway - Pacific Highway	46	191			±	180			44	198							±	180		
Ocean Beach															31	240				
Peninsula - NTC			±	127					±	180	±	235								
Peninsula - Other Neighborhoods			20	96					10	180	9	180			36	240				
Uptown	58	272			62	278	164	674												
Persons per household for mixed-use projects ^a		1.51		2.35		1.48		1.57		2.27		2.23		1.52		2.14		n/a		n/a
R	Maximum allowable residential density, in dwelling units per acre.																			
NR	Maximum allowable nonresidential intensity, in people per acre.																			
±	No dwellings are in the part of the CPA or neighborhood within the indicated Safety Zone. No new dwellings are permitted in this area unless the parcel was designated for residential use in the community plan as of the effective date of this ALUCP.																			
	No part of the Community Planning Area or neighborhood is in the Safety Zone.																			

Land Use Category ^b	Safety Zones					Conditions	Occupancy Factor ¹
	1	2	3	4	5		
LEGEND							
	Compatible Use: Use is permitted.						
	Conditional Use: Use is permitted subject to stated conditions.						
	Incompatible Use: Use is not permitted under any circumstances.						
NOTES							
	Occupancy factor expressed as square feet per person for nonresidential uses in structures. The occupancy factor is used to estimate the average intensity of proposed nonresidential uses. N/A means "not applicable", since the land use does not involve the construction of habitable, nonresidential buildings.						
1							
2	While this is classified as a residential use, it does not include conventional dwelling units. Thus, only the NR intensity limits apply.						
3	Refer to Appendix A for definition of Assembly - Children.						
4	Refer to Appendix A for definitions of manufacturing, processing and storage of hazardous materials.						
5	Biosafety Level 3 facilities handle agents that cause serious or potentially lethal disease through inhalation. Biosafety Level 4 facilities handle agents that cause life-threatening disease and for which there are no vaccines or treatments.						
a	For details on persons per household data, refer to Appendix E3.						
b	Land uses not specifically listed shall be evaluated, as determined by the ALUC, using the criteria for similar uses. Refer to Appendix A.						
c	If this land use occurs within a single- or multi-family residence, it must be evaluated using the criteria for single- or multi-family residential.						

Source: Ricondo & Associates, Inc., ~~July 2013~~ January 2014.
 Prepared by: Ricondo & Associates, Inc., ~~July 2013~~ January 2014.

Policy S.2 Uses Allowed in Safety Zone 1

In Safety Zone 1, new structures are not allowed. Some nonstructural land uses are allowed only in the controlled activity area outside the central portion of the RPZ, see **Table 3-1**. **Exhibit 3-2** depicts the RPZs for each runway end and associated controlled activity areas, based on FAA design standards.² Additional limitations on uses within Safety Zone 1 can be found in **Section 1.7** and **Policy S.10**.

What does “controlled activity area” mean?

*The “controlled activity area” includes the outer parts of the runway protection zone (RPZ) as designated in FAA’s airport design criteria (FAA Advisory Circular 150/5300-13A, Airport Design, Paragraph 302.c.(3)). The controlled activity area is distinct from the “central portion” of the RPZ, which has a width equal to the runway object free area (OFA) and extends from the inner to the outer edges of the RPZ. According to FAA criteria, certain nonstructural land uses may be allowed in the controlled activity area, such as automobile parking, which are not to be allowed in the central portion of the RPZ. **Exhibit 3-2** depicts the RPZs and controlled activity areas at SDIA.*

3.1 Residential Land Uses

The average residential density of a proposed land use project is determined by dividing the number of proposed dwelling units by the net acreage of the project site. The calculated density for the proposed land use project is compared to the allowable maximum density from **Table 3-1** to determine if it is compatible. See **Table 3-2** at the end of this Chapter for an example on how to calculate residential density.

What does “net acreage” mean?

Net acreage refers to the lot area not including land dedicated for public purposes, such as streets or parks. The density and intensity standards in this ALUCP are expressed in net acres.

Residential neighborhoods around the Airport are diverse and have varied existing development patterns. As a result, residential densities vary by safety zone and CPA (or in some cases, neighborhoods within CPAs). In accordance with Handbook guidance, maximum

² Federal Aviation Administration, Advisory Circular 150/5300-13A, *Airport Design*, Paragraphs 302.g., 310.b.(1)(a) and (b), and Figure 3-16.

allowable densities are based on the average density of existing surrounding uses.³ This ensures that future development will be generally consistent with the existing character of each area.

Policy S.3 Maximum Densities Include Density Bonuses

The maximum allowable residential densities established in **Table 3-1** include any density bonuses that local agencies may provide for affordable housing developed in accordance with state or local law. Land use projects with density bonuses cannot exceed the allowable densities established in **Table 3-1**.

Policy S.4 Maximum Densities Exclude Second Dwelling Units

Second dwelling units, as defined by state law,⁴ are not included in calculating the density of a proposed land use project.

Policy S.5 Residential Land Use Designations

As presented on **Exhibit 3-3**, new residential development is allowed within the safety zones (except in Safety Zone 1) only if the affected property is currently designated to allow for residential use in the applicable general or community plan and it complies with the conditions described in **Table 3-1**.

Within the safety zones, general and community plan amendments from nonresidential to residential designations are not allowed.

Exhibit 3-3 depicts parcels located within the safety zones where residential use is allowed under the current general or community plans. These parcels are shaded in yellow on **Exhibit 3-3**. The general and community plans allow residential use in areas designated for mixed-use as well as residential use. The remaining parcels (not shaded in yellow), within the safety zones, are designated in the general and community plans for uses other than residential. Under this policy, nonresidential plan designations within the safety zones cannot be changed to designations that would allow residential use.

³ California Department of Transportation, Division of Aeronautics, *California Airport Land Use Planning Handbook*, October 2011, pp. 4-20 – 4-24. The guidance applies to Safety Zones 3, 4, and 5. Because the affected areas within Safety Zone 2 at SDIA are fully developed and include established residential neighborhoods, the Caltrans guidance was also applied to Safety Zone 2 in this ALUCP.

⁴ California Government Code §65852.150, 65852.

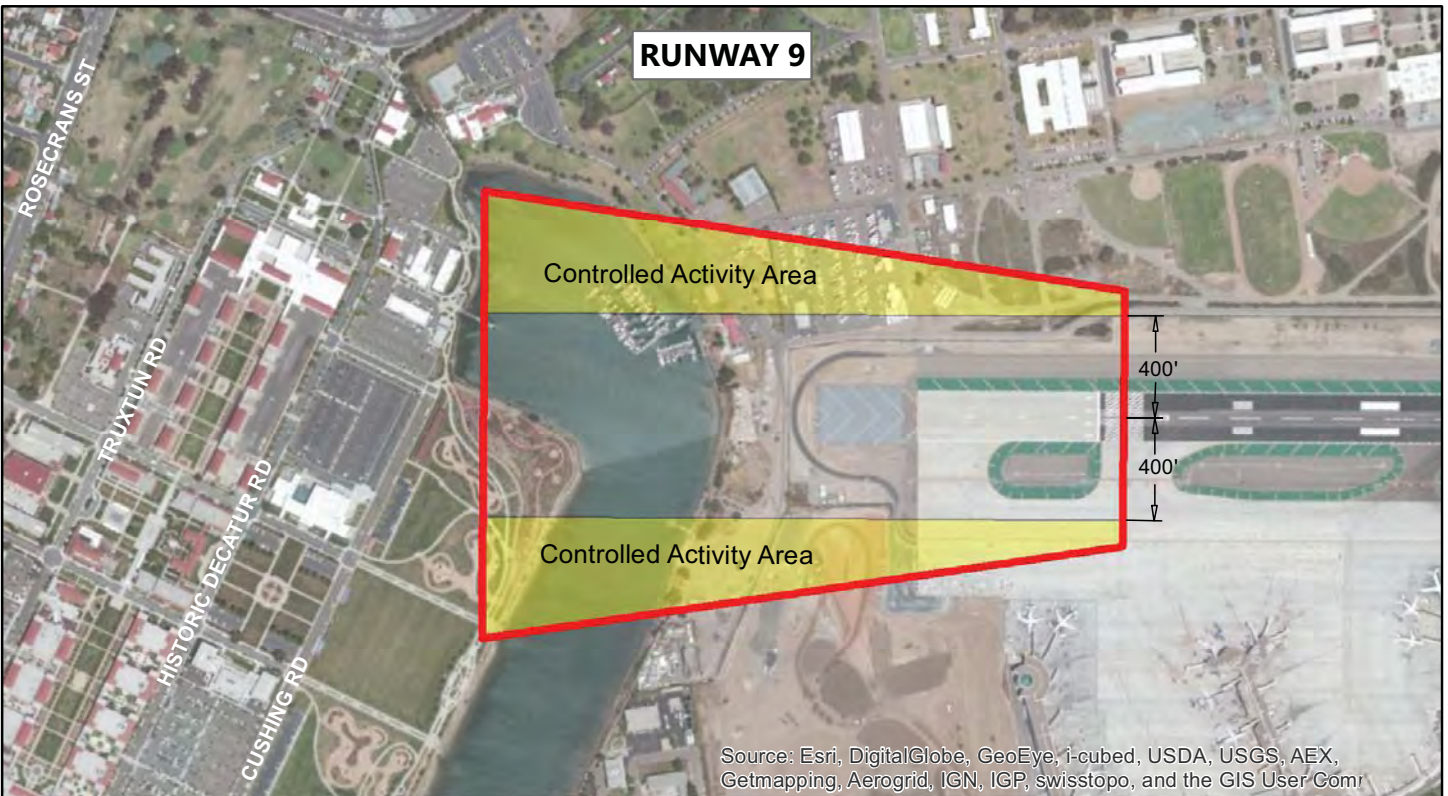

Notes: 1. In addition to limitations established by this ALUCP, the Federal Aviation Administration (FAA) Advisory Circular 150/5300-13, Section 212.a(2)(a) restricts land uses within the Runway Protection Zone (RPZ).
 2. The dimensions of the two RPZs at SDIA differ because of the different approach visibility minimums for each runway end.

Sources: San Diego County Regional Airport Authority, Airport Layout Plan, July 10, 2009 (runway protection zones); Ricondo & Associates, Inc., November 2011 based on Federal Aviation Administration (FAA) Advisory Circular 150/5300-13 Airport Design, Figure 2-3 (controlled activity areas).

Prepared by: Ricondo & Associates, Inc., December 2013.

Exhibit 3-2

Runway Protection Zones and Controlled Activity Areas



- Legend**
- Controlled Activity Area
 - RPZ

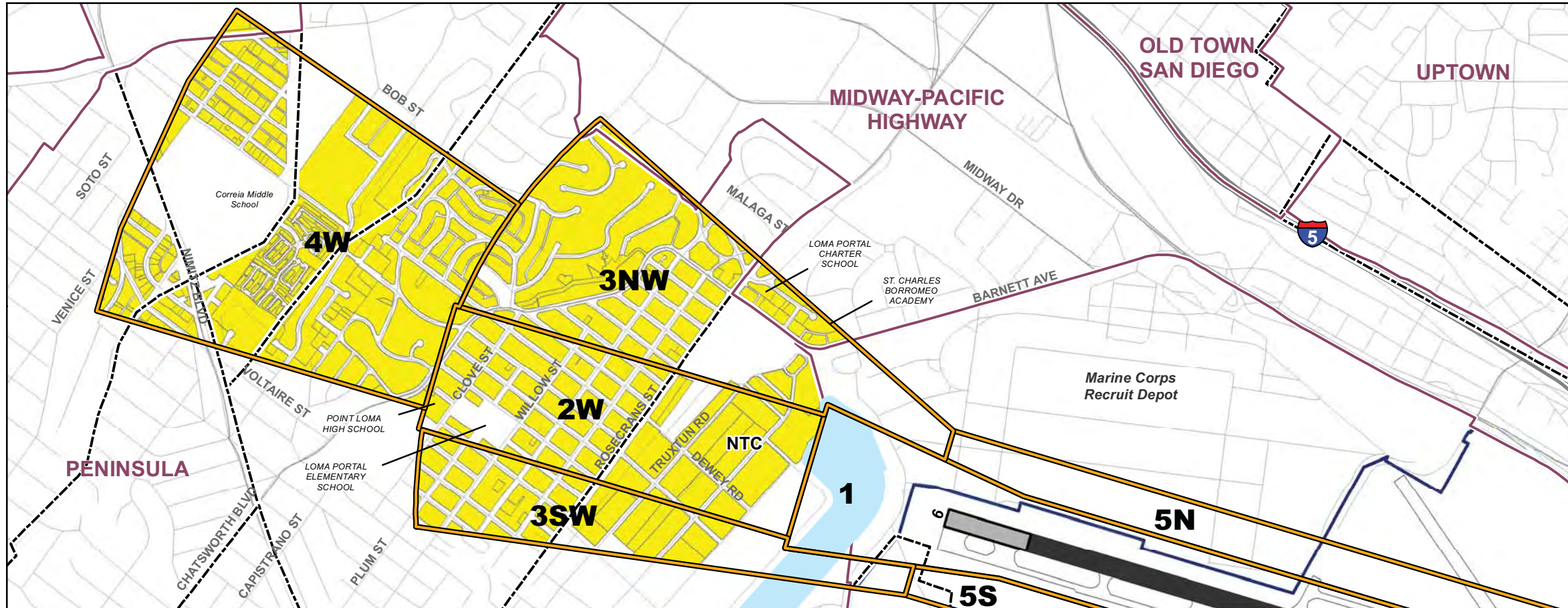

LEGEND

- Major Roads
- Highways
- Community Planning Areas
- Airport Property Boundary
- Displaced Thresholds
- Safety Compatibility Zone
- Neighborhood Boundaries¹

General/Community Plan Land Use

- Residential Use Allowed²



Notes: 1. Only the neighborhoods noted in Table 3-1 "Safety Compatibility Standards" are labeled on this exhibit.

2. The general plan and community plans allow residential use in areas designated for mixed-use as well as residential use. Residential use is also allowed in some areas designated for commercial use. The remaining parcels within the safety zones (not shaded in yellow), are designated in the general and community plans for uses other than residential.

Sources: San Diego Geographic Information Source (SanGIS) updated in 2011 (roads and highways); City of San Diego, August 2011 (neighborhood boundaries); Ricondo & Associates, Inc., February 2011, based on information received from the City of San Diego Development Services Planning Division (general plan land use designation GIS data for Peninsula, Midway-Pacific Highway, Old Town San Diego, Uptown, Centre City and Greater Golden Hill community planning areas).

Prepared by: Ricondo & Associates, Inc., December 2013.

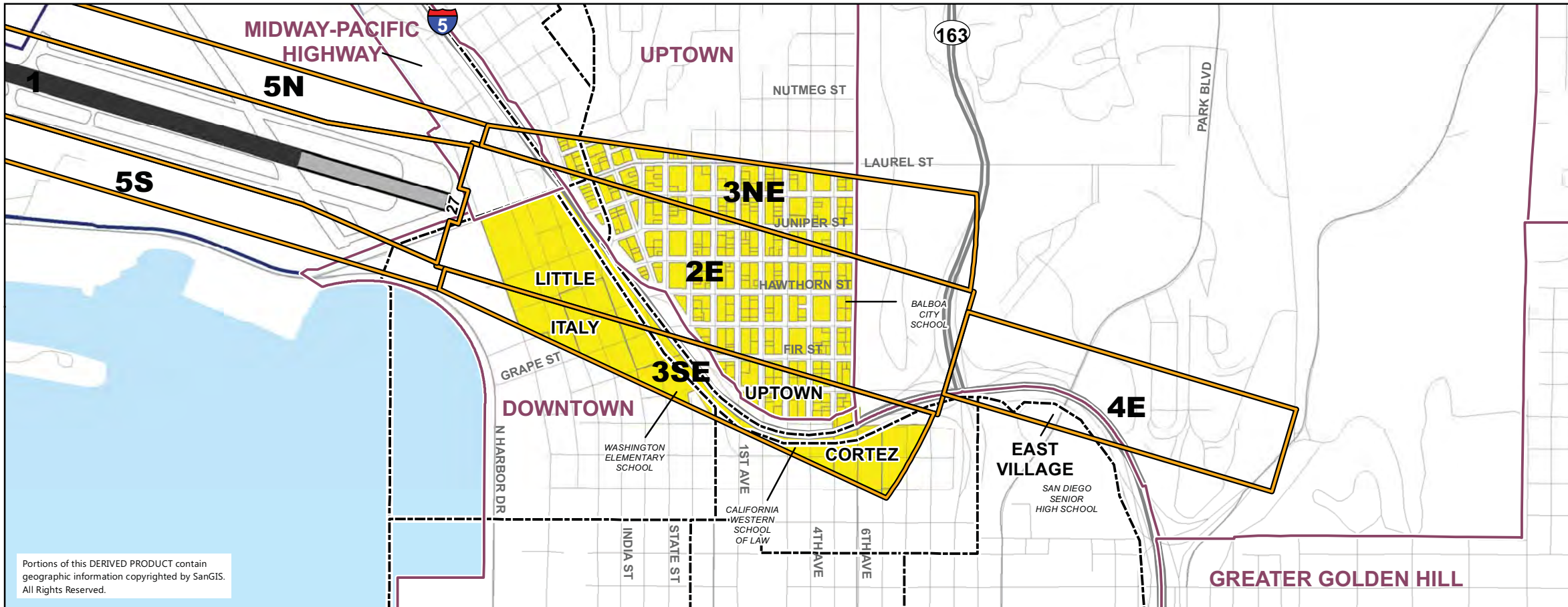

Portions of this DERIVED PRODUCT contain geographic information copyrighted by SanGIS. All Rights Reserved.

Exhibit 3-3

Residential Use Allowed under the General/Community Plans Inside Safety Compatibility Zones

3.2 Nonresidential Land Uses

See **Table 3-2** for an example on how to calculate nonresidential intensity.

Neighborhoods around the Airport are diverse and have varied existing nonresidential development patterns. As a result, nonresidential intensities vary by safety zone and CPA (or in some cases, neighborhoods within CPAs). In accordance with Handbook guidance, maximum allowable intensities are based on the average intensity of existing surrounding uses. This ensures that future development will be generally consistent with the existing character of each area.

Policy S.6 Nonresidential Projects with a Single Use

The total intensity of a nonresidential project must not exceed the maximum allowable intensity for the use as shown in **Table 3-1**. To determine the number of people occupying the use, divide the gross square footage of the building by the occupancy factor shown in **Table 3-1**. The total number of occupants is then divided by the net acreage of the project site to determine intensity.

Areas devoted to parking (whether above ~~or~~ below ground or enclosed) are not to be included in the gross square footage of the building and, therefore, are not considered in the calculation of intensity.

See **Table 3-2** for an example of how to calculate nonresidential intensity.

Policy S.7 Nonresidential Projects with Multiple Uses

The total intensity of a project with a mix of nonresidential uses must not exceed the maximum allowable intensity as shown in **Table 3-1**. The number of people occupying each component use is calculated separately. The total number of occupants is then divided by the net acreage of the project site to determine intensity.

Areas devoted to parking (whether above ~~or~~ below ground or enclosed) are not to be included in the gross square footage of the building and, therefore, are not considered in the calculation of intensity.

See **Table 3-2** for an example of how to calculate nonresidential intensity with a mix of nonresidential uses.

3.3 Supplemental Safety Compatibility Policies

Policy S.8 Mixed-Use Projects

For a proposed project with a mix of residential and nonresidential uses, the residential density must be calculated (Step 1) and then converted to a ~~nonresidential-residential~~ intensity level (Step 12). The nonresidential intensity is then calculated (Step 23). The sum total of the project's residential and nonresidential intensities (Step 4) cannot exceed the allowed intensity limit identified in **Table 3-1**. The residential density limits identified in **Table 3-1** ~~do not also~~ apply to ~~mixmixed~~-use projects.

Step 1: The density of the residential portion of the proposed project is calculated by dividing the number of dwelling units by the net acreage of the entire project site. The number of dwelling units is limited to the maximum density specified in Table 3-1.

Step 2: The resulting residential density is then converted to "intensity" by multiplying the density, in units per acre, by the number of persons per household for the corresponding CPA/neighborhoodsafety zone indicated at the top of **Table 3-1**.

Step 23: Nonresidential intensity is calculated by dividing the total occupants of the nonresidential uses by the net acreage of the project site. (The number of occupants is calculated by dividing the gross square footage of the building by the occupancy factor shown in **Table 3-1**.) If different types of nonresidential uses are proposed, the number of people occupying each component nonresidential use is calculated separately, as presented in **Table 3-2**, Example D.

Step 4: The residential and nonresidential intensities calculated in Steps 2 and 3 are summed, and the total intensity level is compared with the maximum allowable intensity limits presented at the top of Table 3-1 to determine if the proposed use complies with the ALUCP.

For live/work projects, each dwelling unit is to be counted towards density (then converted to intensity per Step 2 above), and only the ground floor square footage devoted to nonresidential use is to be used in the calculation of nonresidential intensity per Step 3 above.

Areas devoted to parking (whether above ~~or~~/below ground or enclosed) are not to be included in the gross square footage of the building and, therefore, are not considered in the calculation of intensity.

Policy S.9 Ancillary Uses

Ancillary uses are primarily intended for use by the employees/residents/occupants of a land use project and **typically cumulatively** occupy **less-no more** than 10 percent of the total floor area.

Ancillary uses occupying **less-no more** than 10 percent of the total floor area that are compatible (green) or conditionally compatible (yellow) according to **Table 3-1** are not included in the calculation of intensity. Ancillary uses that are listed as “incompatible” (red) in **Table 3-1** are not permitted.

Policy S.10 Buildings Split by Safety Zone Boundaries

Buildings located partly within a single safety zone—when 50 percent or more of the building, as determined by gross floor area (in square feet), the requirements of that safety zone apply. When less than 50 percent of the building is located within a safety zone, no safety restrictions apply. However, no building or portion of a building is permitted within Safety Zone 1.

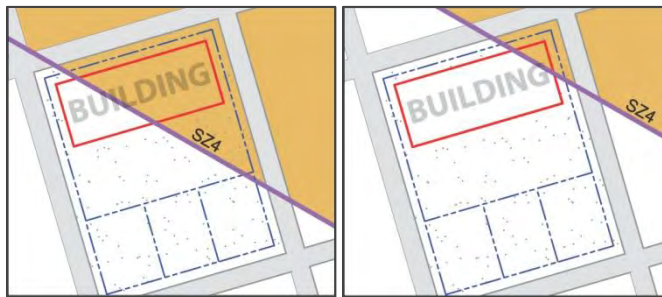

For Illustrative Purposes Only

Building located within two or more safety zones—the standards of the safety zone in which the greatest portion of the building, as determined by gross floor area (in square feet), is located apply. However, no building or portion of a building is permitted within Safety Zone 1.

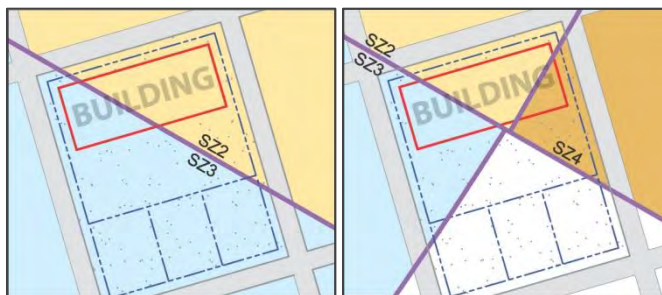

For Illustrative Purposes Only

Building located equally within two or more safety zones—the standards of the most restrictive safety zone in which the building is located apply. However, no building or portion of a building is permitted within Safety Zone 1.



For Illustrative Purposes Only

Policy S.11 Land Uses Not Specified in Table 3-1

For any proposed land use that is not specified in **Table 3-1**, the ALUC must determine the most similar land use based upon the land use definitions and guidance in **Appendix A**. Once the most similar use is determined, standards for that use apply.

Policy S.12 New Uses in Existing Buildings

No consistency review is required when new uses are proposed within a portion of an existing building, such as a multi-tenant shopping center. Only those uses described in **Table 3-1** as compatible or conditionally compatible are allowed; incompatible uses are not allowed.

Consistency review is required when a new use (or multiple uses) is proposed to entirely occupy an existing building as indicated below.

Nonresidential Projects:

1. The maximum intensity is limited as described in **Policies S.6** and **S.7**.
2. If the overall size of the existing building results in a calculated intensity that exceeds the maximum limit, an occupancy deed restriction could be recorded on the property limiting the occupancy of the building to no more than the maximum limit.

Residential Projects: The total density of a residential project must not exceed the maximum allowable density as shown in **Table 3-1**.

Mixed-use Projects: The maximum density and intensity are limited as described in **Policy S.8**.

Table 3-2 (1 of 5) Examples

<p>Example A: Calculating Residential Density</p> <p>A condominium project is proposed in Safety Zone 3NW in the Midway – Pacific Highway CPA.</p>	
<p>Project Details:</p> <p>Site area: 0.25 acres</p> <p>Number of dwelling units: 10</p>	<p>Calculations:</p> <p>Divide the number of units by the site area, in net acres, to determine the density of the project.</p> <p>10 dwelling units ÷ 0.25 acres = 40 units/acre</p>
<p>Result: The density of 40 units per acre is less than the allowable maximum of 44 units per acre indicated in Table 3-1 for the Midway – Pacific Highway CPA in Safety Zone 2NW. Therefore, the proposed project is compatible</p>	

<p>Example B: Calculating Nonresidential Intensity</p> <p>A retail project is proposed in Safety Zone 3NE in the Uptown CPA.</p>	
<p>Project Details:</p> <p>Site area: 0.25 acres</p> <p>Total building floor area: 6,300 square feet</p> <p>Retail uses: Clothing, toys, jewelry and gifts</p>	<p>Calculations:</p> <p>The proposed retail uses are in the “high density retail” category in Table 3-1 which has an occupancy factor of 120. Divide the floor area by the occupancy factor to estimate the number of building occupants.</p> <p>6,300 square feet ÷ 120 square feet/person = 52.5 occupants</p> <p>Divide the number of occupants by the site area to determine the intensity of the proposed retail project.</p> <p>52.5 occupants ÷ 0.25 acres = 210.0 people/acre</p>
<p>Result: The intensity of 210 people per acre is less than the allowable maximum of 278 people per acre indicated in Table 3-1 for the Uptown CPA in Safety Zone 3NE. Therefore, the proposed project is compatible.</p>	

Table 3-2 (2 of 5) Examples

Example C: Calculating Intensity for a Nonresidential Project with a Mix of Uses

An office/restaurant project is proposed in Safety Zone 3SE in the Little Italy neighborhood in the **Centre City Downtown** CPA.

Project Details:**Site area:**

0.25 acres

Office area:

7,000 square feet

Restaurant area:

9,000 square feet

Total building floor area:

16,000 square feet

Calculations:

Divide the square feet of the office and restaurant by the corresponding occupancy factors in **Table 3-1** (215 and 60, respectively) to estimate the number of occupants.

Office: $7,000 \text{ square feet} \div 215 \text{ square feet/person} = 32.6 \text{ office occupants}$

Restaurant: $9,000 \text{ square feet} \div 60 \text{ square feet/person} = 150.0 \text{ restaurant occupants}$

$32.6 \text{ office occupants} + 150.0 \text{ restaurant occupants} = 182.6 \text{ total occupants}$

Divide the total occupants by the site area to determine the intensity of the proposed office/restaurant project.

$182.6 \text{ total occupants} \div 0.25 \text{ acres} = 730.4 \text{ people/acre}$

Result: The intensity of 730 people per acre is less than the allowable maximum of 732 people per acre indicated in **Table 3-1**. **Therefore, the proposed project is compatible.**

Note: Totals may not sum as indicated due to rounding.

What is an occupancy factor?

The occupancy factor is an estimate of the amount of floor area attributable to an occupant of a nonresidential land use. It is used to estimate the total number of people occupying a nonresidential use during periods of typical activity. It does not indicate maximum structural capacity, maximum peak occupancy, or maximum occupancy allowed under any health or safety codes.

Table 3-2 (3 of 5) Examples

<p>Example D: Calculating Density/Intensity for a Residential/Nonresidential Mixed-Use Project</p> <p>An office/retail/residential project is proposed in Safety Zone 2W in the “other neighborhoods” portion of the Peninsula CPA.</p>	
<p>Project Details:</p> <p>Site area: 0.25 acres</p> <p>Office area: 860 square feet</p> <p>Retail area: 1,190 square feet</p> <p>Residential units: 5 units</p> <p>Total building floor area: 4,000 square feet</p>	<p>Calculations:</p> <p>Residential: Calculate residential density by dividing the number of units by the site area (in acres).</p> <p>$5 \text{ units} \div 0.25 \text{ acres} = 20.0 \text{ units/acre}$</p> <p>Convert the residential density into intensity by multiplying the residential density (number of units per acre) calculated above by the number of persons per household in Table 3-1.</p> <p>$20 \text{ units/acre} \times 2.35 = 47 \text{ persons per acre}$</p> <p>Nonresidential: Divide the square feet of the office and retail uses by the corresponding occupancy factors in Table 3-1 (215 and 170, respectively) to estimate the number of occupants.</p> <p>Office: $860 \text{ square feet} \div 215 \text{ square feet/person} = 4 \text{ office occupants}$</p> <p>Retail: $1190 \text{ square feet} \div 170 \text{ square feet/person} = 7 \text{ retail occupants}$</p> <p>Total nonresidential occupants: 11</p> <p>Calculate nonresidential intensity by dividing the total number of occupants by the site area.</p> <p>$11 \text{ total occupants} \div 0.25 \text{ acres} = 44.0 \text{ people/acre}$</p>

Table 3-2 (4 of 5) Examples

Example D (continued): Calculating Density/Intensity for a Residential/Nonresidential Mixed-Use Project

An office/retail/residential project is proposed in Safety Zone 2W in the “other neighborhoods” portion of the Peninsula CPA.

Result:

The residential density is 20 dwelling units per acre, which is equal to the maximum allowable residential density, as indicated in **Table 3-1**.

The residential “intensity” is 47 persons per acre and the nonresidential intensity is 44 people per acre, for a total of 91 people per acre. The allowable maximum is 96 people per acre, as indicated in **Table 3-1**.

The total project “intensity” is less than the maximum nonresidential intensity of 96 people per acre.

Therefore, the proposed project is compatible.

Note: Totals may not sum as indicated due to rounding.

Example E: Calculating Density/Intensity for a Live/Work Project

A live/work project is proposed in Safety Zone 2E in the Downtown CPA.

Project Details:**Site area:**

0.66 acres

Ground floor “work” area:

13,600 square feet

Residential units:

17 units

Calculations:Residential:

Calculate residential density by dividing the number of units by the site area (in acres).

$17 \text{ units} \div 0.66 \text{ acres} = 26 \text{ units/acre}$

Convert the residential density into intensity by multiplying the residential density (number of units per acre) calculated above by the number of persons per household in **Table 3-1**.

$26 \text{ units/acre} \times 1.51 = 39 \text{ persons per acre}$

Nonresidential:

Divide the square feet of the office portion by the corresponding occupancy factors in **Table 3-1** (215) to estimate the number of occupants.

$13,600 \text{ square feet} \div 215 \text{ square feet/person} = 63 \text{ office occupants}$

Total nonresidential occupants: 63

Table 3-2 (5 of 5) Examples

<p>Calculate nonresidential intensity by dividing the total number of occupants by the site area.</p> <p>63 total occupants ÷ 0.66 acres= 95 people/acre</p>	
<p>Result:</p> <p>The residential density is 26 dwelling units per acre, which is less than the maximum allowable residential density, as indicated in Table 3-1.</p> <p>The residential “intensity” is 39 persons per acre and the nonresidential intensity is 95 people per acre, for a total of 134 people per acre. The allowable maximum is 255 people per acre, as indicated in Table 3-1.</p> <p>The total project “intensity” is less than the maximum nonresidential intensity of 255 people per acre.</p> <p>Therefore, the proposed project is compatible.</p> <p>Note: Totals may not sum as indicated due to rounding.</p>	

<p>Example F: Calculating Intensity for a Hotel Project</p> <p>A hotel (with eating and drinking space) is proposed in Safety Zone 2E in the Little Italy neighborhood of the Downtown CPA.</p>	
<p>Project Details:</p> <p>Site area: 0.25 acres</p> <p>Hotel: 14 rooms</p> <p>Eating and Drinking area: 3,000 square feet</p> <p>Total building floor area: 32,670 square feet</p>	<p>Calculations:</p> <p>Hotel: Hotels in SZ 2E are limited to 56 rooms per acre per Table 3-1. Calculate the intensity by dividing the site size by the number of hotel rooms.</p> <p>14 rooms ÷ 0.25 acres = 56 rooms/acre</p> <p>Eating and Drinking: 3,000 square feet is less than 10% of the total floor area of the project and therefore is not counted when calculating intensity.</p>
<p>Result:</p> <p>The intensity is 56 rooms per acre, which is the maximum allowable for hotels in Safety Zone 2, as indicated in Table 3-1. No intensity would be assigned to the eating and drinking establishment because it is less than 10% of the total floor area per Policy S.9.</p> <p>Therefore, the proposed project is compatible.</p> <p>Note: Totals may not sum as indicated due to rounding.</p>	



CHAPTER 4

Airspace Protection Policies and Standards

Chapter 4 provides an airspace protection boundary map for San Diego International Airport (SDIA or the Airport) and applicable policies and standards.

Appendix E4 provides the technical basis for delineating the airspace protection boundary and establishing the policies and standards.

In addition to the policies and standards established by this chapter, a project sponsor must also review all policies and standards established by this ALUCP.

The policies of this chapter apply only to new development or redevelopment. The policies do not apply to existing land uses, except as noted in **Section 1.6** in **Chapter 1**.

A list of the airspace protection policies is provided below.

<u>Policy A.1</u>	Airspace Protection Boundary
<u>Policy A.2</u>	FAA Notification Requirements
<u>Policy A.3</u>	Hazards
<u>Policy A.4</u>	Threshold Siting Surfaces
<u>Policy A.5</u>	Compatible Structure or Object
<u>Policy A.6</u>	Conditionally Compatible Obstructions
<u>Policy A.7</u>	Standards for the Protection of Flight Safety
<u>Policy A.8</u>	Avigation Easement Dedication

What is an Obstruction?

An object that exceeds the obstruction standards established in 14 CFR Part 77, as determined by the FAA. Obstructions must be marked, lighted and identified in aeronautical publications so they are easily recognized by pilots.

What is a Hazard?

An object or condition that would compromise flight safety as determined by the FAA.

Airspace Protection Policies and Standards

Policy A.1 Airspace Protection Boundary

The airspace protection boundary, as depicted on **Exhibit 4-1**, establishes the area where the policies and standards of this chapter apply. Additional boundaries at the ends of the runway represent the Threshold Siting Surfaces (TSSs) within which specific height limitations apply. See **Section 4.3** for additional information on TSSs.

The airspace protection boundary is based on the outermost edge of the following airspace surfaces:

1. Part 77, Subpart B, 100:1 notification surface boundary
2. Part 77 civil airport imaginary airspace surfaces
3. The approach surfaces for both runway ends defined by the criteria in FAA Order 8260.3B, United States Standard for Terminal Instrument Procedures (TERPS)

What is a Threshold Siting Surface?

*A Threshold Siting Surface (TSS) defines critical airspace that must be protected to allow for safe approaches to runways. Any objects penetrating the TSSs would cause the runway thresholds to be further displaced, reducing available landing distances. See **Section E4.2.5** in **Appendix E** for detailed information.*

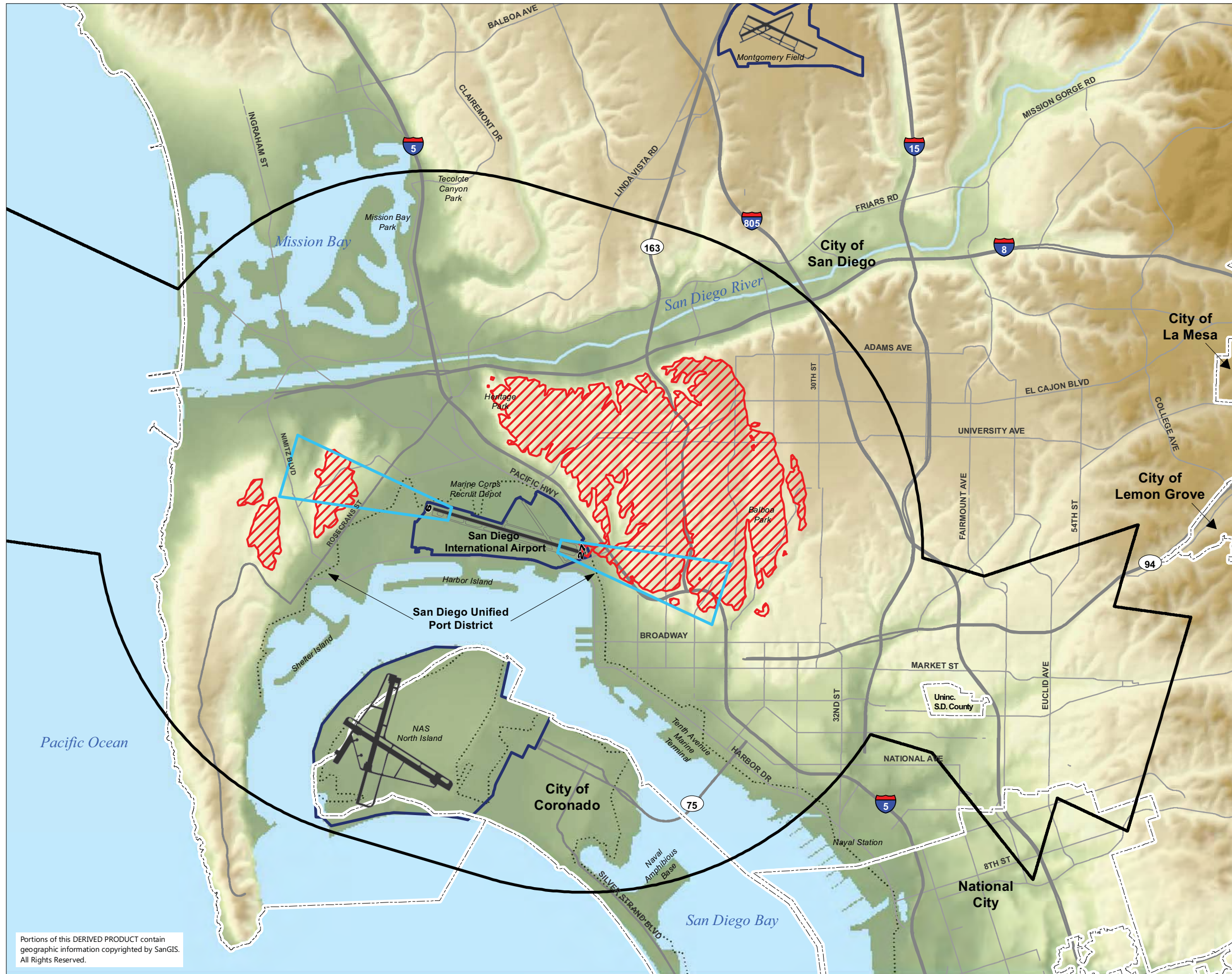

LEGEND

- Major Roads
- Highways
- - - Municipal Boundaries
- ▭ Airport Property Boundary
- ▭ Airspace Protection Boundary¹
- ▭ Threshold Siting Surface
- ▨ Terrain Penetrations of FAR Part 77 Surfaces

Terrain Elevations (in feet MSL)

- High : 847
- Low : 1



Notes: 1. The Airspace Protection Boundary is defined as the outer boundary of the combined Part 77 Subpart B, Subpart C and TERPS approach surface boundaries.

Sources: San Diego Geographic Information Source (SanGIS), 2008 and 2011 (municipal boundaries, roads and highways); Ricondo & Associates, Inc., July 2011 (airspace protection boundary and threshold siting surface; terrain penetrations based on San Diego Association of Governments (SANDAG) 30 meter raster elevation data in Digital Elevation Model).

Prepared by: Ricondo & Associates, Inc., December 2013.

Portions of this DERIVED PRODUCT contain geographic information copyrighted by SanGIS. All Rights Reserved.

**Exhibit 4-1
Airspace
Protection Boundary**

4.1 FAA Notification of Proposed Construction or Alteration

Federal law requires project sponsors of structures or objects (including structures, antennas, trees, and mobile and temporary objects, such as construction cranes) that exceed Part 77 height criteria to submit to the FAA a Notice of Proposed Construction or Alteration (Form 7460-1).¹ Additionally, the FAA may also require notification for structures or objects that may cause signal reception interference with navigational aids (NAVAIDs). Project sponsors may refer to this FAA [website](#)² to determine if they are required to file Form 7460-1 with the FAA.

Policy A.2 FAA Notification Requirements

Project sponsors must comply with FAA notice requirements for proposed construction or alteration of objects exceeding certain heights or that could potentially interfere with NAVAIDs by filing of Form 7460-1 with the FAA, if required.

Regardless of location, sponsors of proposed projects shall notify the FAA of proposed structures or objects exceeding 200 feet above ground level.

Project sponsors must include a copy of the FAA notice of determination letter with their consistency applications to the ALUC if FAA review is required.

See **Appendix B** for the submittal requirements under ALUCP consistency determination application process.

Exhibit 4-2 presents an example illustration related to the 14 CFR Part 77 Notification Criteria.

¹ Title 14, Code of Federal Regulations, Part 77, *Safe, Efficient Use, and Preservation of the Navigable Airspace*, Subpart B, *Notice Requirements*, §77.7.

² Federal Aviation Administration, Department of Obstruction Evaluation/Airport Airspace Analysis (OE/AAA), *Notice Criteria Tool*, <https://oeaaa.faa.gov/oeaaa/external/gisTools/gisAction.jsp?action=showNoNoticeRequiredToolForm>.

Federal law requires sponsors of certain proposed projects to file with the FAA a Notice of Proposed Construction or Alteration (FAA Form 7460-1). This applies to proposed objects taller than 200 feet above the ground anywhere in the United States and shorter objects within 20,000 feet of runways longer than 3,200 feet or within 10,000 feet of shorter runways. This requirement applies to all proposed objects including structures, antennas, trees, mobile objects, and temporary objects, such as construction cranes. For more information, refer to this website.²

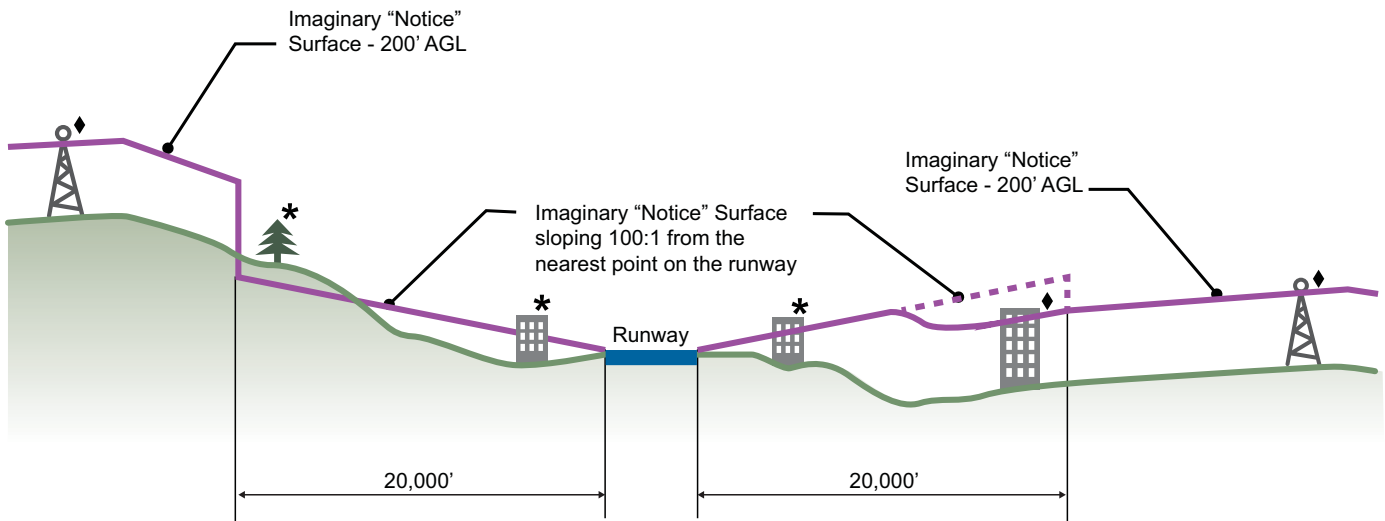

- ◆ 14 CFR §77.9(a) Any proposed construction or alteration more than 200 feet in height above ground level (AGL) at its site requires notice.
- * 14 CFR §77.9(b) Any proposed construction or alteration penetrating imaginary surfaces in proximity to runways or heliports requires notice.

Notes:

1. Note: Proposed construction or alteration that is lower than 200 feet AGL and is lower than the 100:1 notification surfaces may require notification under other requirements. Please see §77.9(c) and §77.9(d)
2. <https://oeaaa.faa.gov/oeaaa/external/gisTools/gisAction.jsp?action=showNoNoticeRequiredToolForm>

Source: Adapted from FAA Order JO 7400.2J, Procedures for Handling Airspace Matters, Figures 5-2-1 and 5-2-2.

Prepared by: Ricondo & Associates, Inc., May 2012.



Exhibit 4-2

Notice of Federal Requirement

4.2 Hazards

Hazards are obstructions or other adverse objects that FAA aeronautical study concludes would have a “substantial adverse effect” to a “significant volume of aeronautical operations.”³ Objects that are hazards to navigation have been so determined because they are not sufficiently clear from the normal pathways of aircraft, would affect the useable length of an existing or planned runway, or because they result in certain other adverse effects, such as electromagnetic interference, control tower visibility hindrances, or pilot distraction.⁴

Policy A.3 Hazards

Hazards, as determined by the FAA, are incompatible with the airspace protection policies and are not allowed.

4.3 Threshold Siting Surfaces

A Threshold Siting Surface (TSS) defines critical airspace that must be protected to allow for safe approaches to runways. Any objects penetrating the TSSs would cause the runway thresholds to be further displaced, reducing available landing distances. **Exhibit 4-3** presents the TSSs at SDIA in plan and profile views. **Exhibit 4-4** presents the concept of a displaced runway threshold.

Policy A.4 Threshold Siting Surfaces

Proposed structures or objects penetrating a TSS, as depicted on **Exhibit 4-3**, are incompatible with the airspace protection policies and are not allowed. Sponsors of proposed land use projects within either TSS boundary must provide evidence that the proposed structure or object will not penetrate a TSS.

What is a Displaced Runway Threshold?

*The runway threshold marks the beginning of the portion of the runway available for landings. Typically, the threshold is located at the end of the runway pavement. At SDIA, the thresholds have been shifted down the runway – or displaced – to ensure that approaching aircraft can clear obstacles. The problem with displaced thresholds is that they reduce the runway length available for aircraft landings. In the example illustrated on **Exhibit 4-4**, a 500-foot displaced threshold is needed to ensure clearance of an object on the hill east of the runway.*

³ Federal Aviation Administration, Order JO 7400.2J, *Procedures for Handling Airspace Matters*, Sections 6-3-3 and 6-3-4.

⁴ Federal Aviation Administration, Order JO 7400.2J, *Procedures for Handling Airspace Matters*, Section 6-3-3.

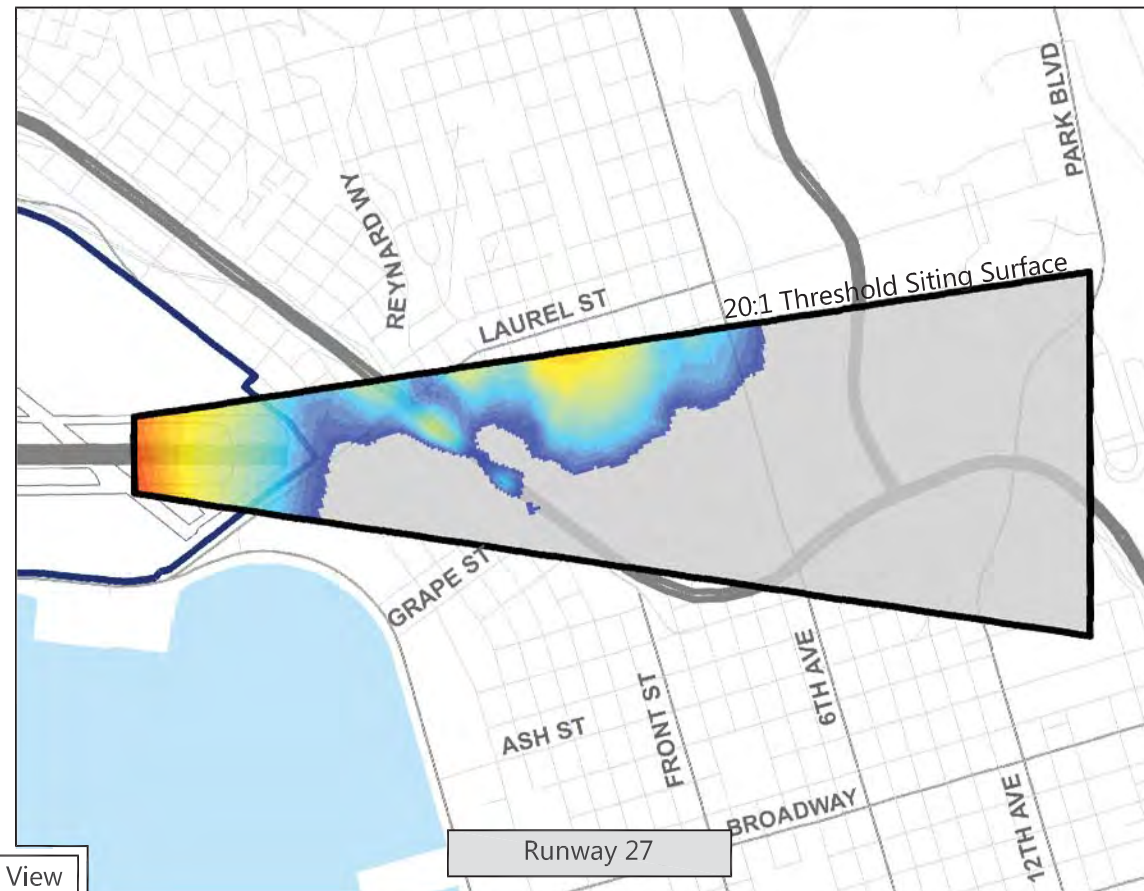
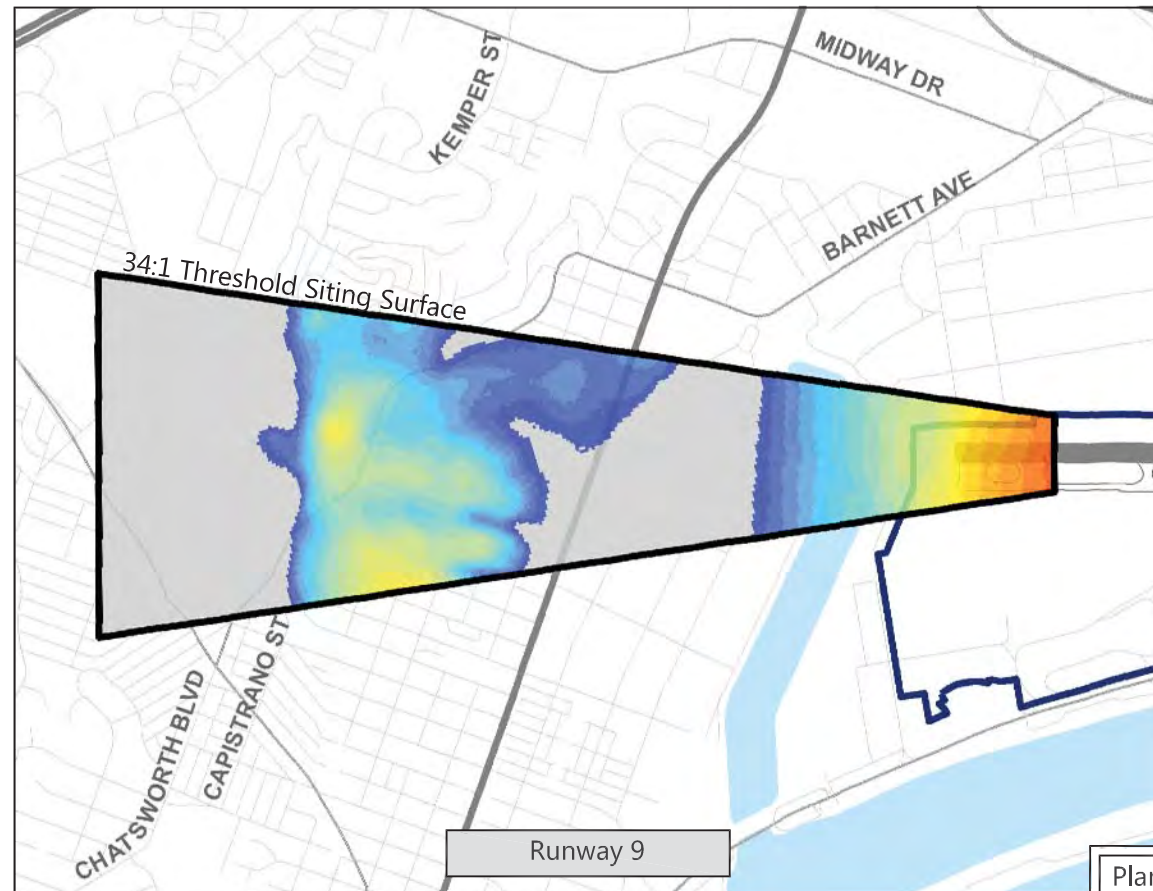

LEGEND

- Major Roads
- Highways
- Airport Property Boundary
- Threshold Siting Surface

Heights of Airspace Surface Above Ground Level (AGL)

- 0-10
- 10-15
- 15-20
- 20-25
- 25-30
- 30-35
- 35-40
- 40-45
- 45-50
- 50-55
- 55-60
- 60-65
- 65-70
- 70-75
- 75-80
- 80-85
- 85-90
- 90-95
- 95-100
- 100+



Notes:

1. Ground profile depicts terrain along extended runway centerline.
2. Threshold Siting Surfaces (TSSs) are surfaces that rise away from each runway end. A project located in close proximity to the end of the runway would have a smaller height buffer available compared to a project located further away from the runway. The available height buffer would be further reduced if the project is located in an area of high terrain. To help assess how much buffer or height would be available between the ground surface and the TSS surfaces above, calculations were made to subtract the ground elevation from the TSS surface elevation.

Sources: San Diego Graphic Information Source (SanGIS), 2008 and 2011 (municipal boundaries, roads, and highways); Ricondo & Associates, Inc. April 2012, based on San Diego Association of Governments (SANDAG) 30 meter raster elevation data in Digital Elevation Model, November 2010; Federal Aviation Administration Advisory Circular 150/5300-13A *Airport Design* (Threshold Siting Surface).

Prepared by: Ricondo & Associates, Inc., December 2013.

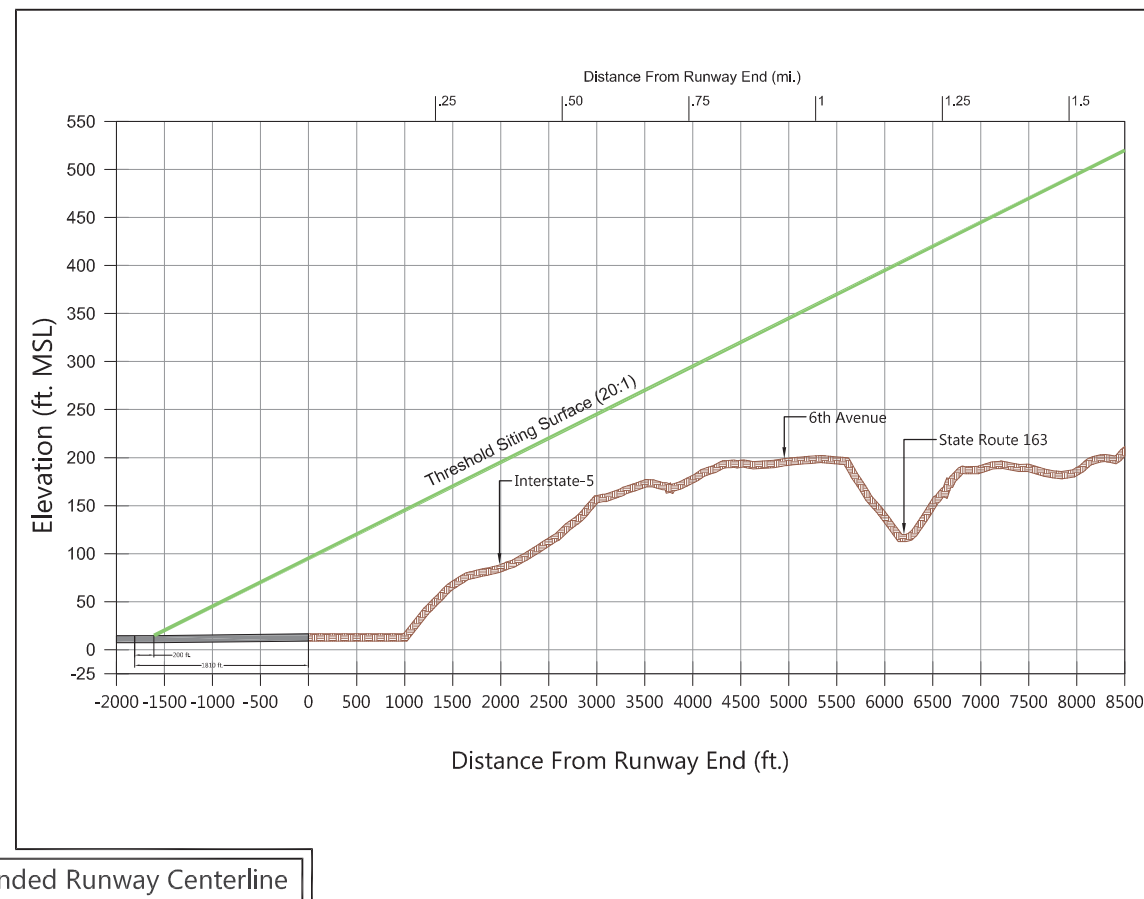
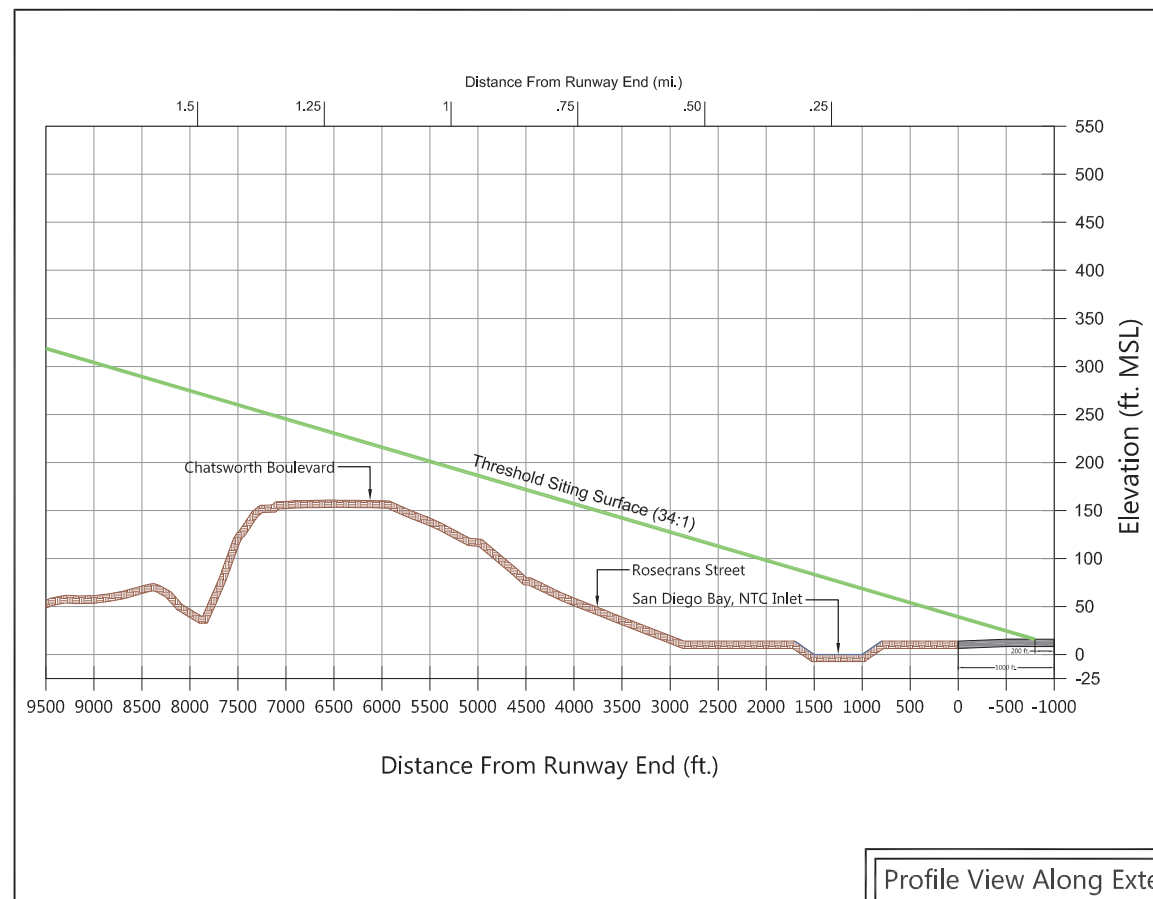

Profile View Along Extended Runway Centerline

Exhibit 4-3

Threshold Siting Surfaces Profile

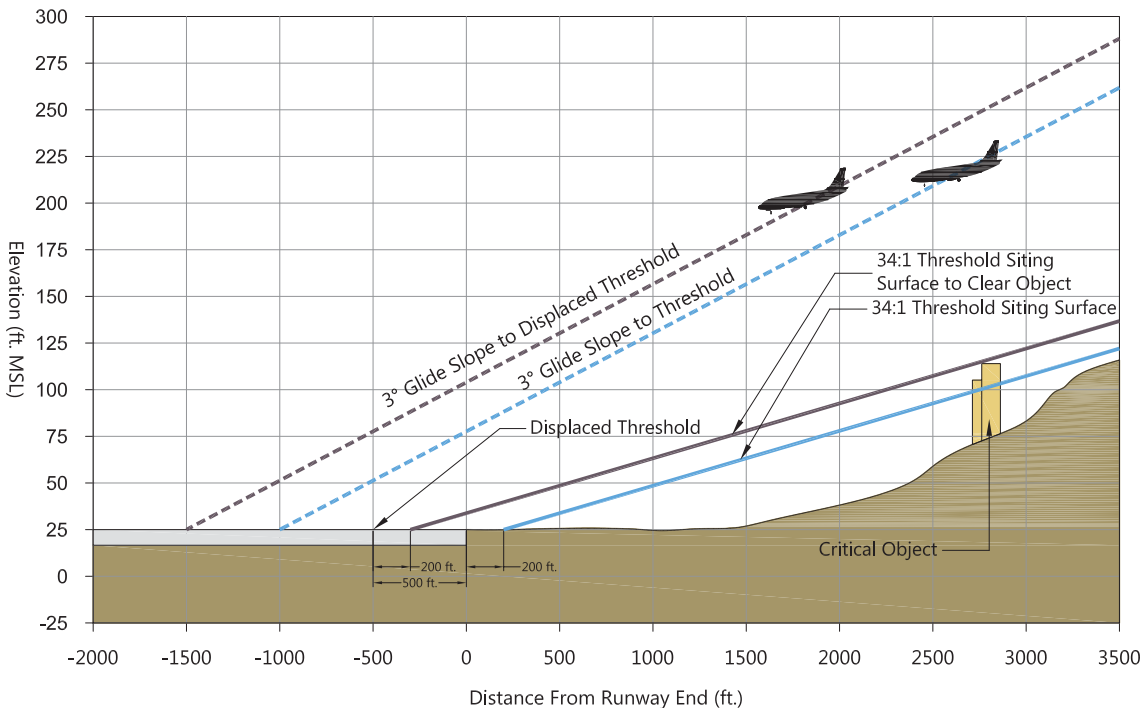
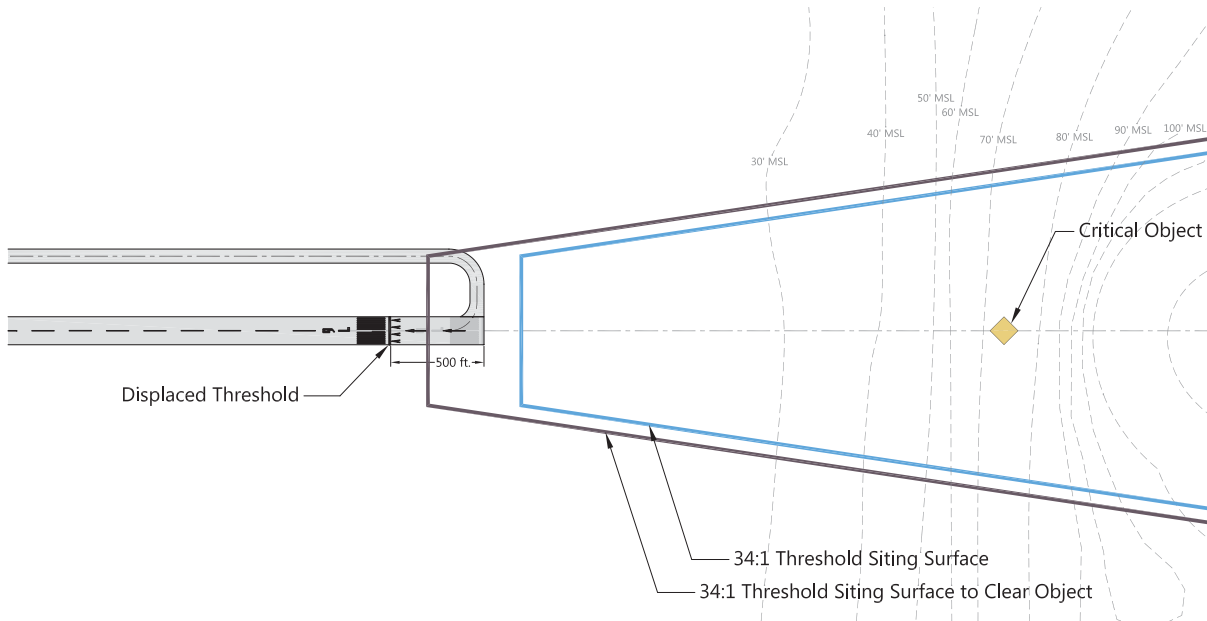

Source/Prepared by: Ricondo & Associates, Inc., July 2012.



Exhibit 4-4

Displaced Runway Threshold – Example

4.4 Compatibility of Structures and Objects

After receiving a Form 7460-1 Notice of Proposed Construction or Alteration, the FAA undertakes an obstruction evaluation and aeronautical study to determine the effect of the proposed structure or object on the use of airspace. Through its study, the FAA determines if the proposed structure or object would be an obstruction to air navigation, a hazard to air navigation, or neither.

Policy A.5 Compatible Structure or Object

A proposed structure or object is compatible with the airspace policies if the FAA determines that it is not an obstruction to air navigation.

Policy A.6 Conditionally Compatible Obstructions

If a proposed structure or object is determined to be an obstruction, it may be made conditionally compatible with this ALUCP if all the following apply:

1. The proposed project does not penetrate a TSS
2. As a result of an aeronautical study, the FAA determines that the obstruction would not be a hazard to air navigation
3. FAA analysis determines that the object would not cause any of the following:
 - (a) An increase in the ceiling or visibility minimums for an existing or planned instrument procedure⁵
 - (b) A reduction of the operational efficiency and capacity of the Airport
 - (c) Conflict with visual flight rules (VFR) airspace
4. Sponsors of a proposed structure or object must comply with the findings of FAA aeronautical studies (e.g., reduce structure height, install obstruction lighting systems and/or painting/markings of structures) performed under Part 77 regulations⁶
5. An aviation easement is dedicated to the Airport operator

⁵ A planned procedure is one that is formally on file with the FAA or that is consistent with the FAA-approved Airport Layout Plan.

⁶ Federal Aviation Administration, Advisory Circular 70/7460-1K, *Obstruction Marking and Lighting*.

4.5 Standards for the Protection of Flight Safety

Local agencies must consult with the FAA, the ALUC and the Airport operator when proposed land use projects within the Airspace Protection Boundary may cause any hazard described in the following sections.

Policy A.7 Standards for the Protection of Flight Safety

Policy A.7.1 Sources of Glare

Highly reflective materials may cause visual after-images or flash blindness in pilots, thus compromising flight safety.

Such materials are incompatible unless the ALUC finds that either of the following conditions applies:

1. The project sponsor has prepared a technical study, certified by a lighting engineer or an expert approved by the ALUC, demonstrating to the ALUC's satisfaction that the proposed building materials would not create reflections intense enough to cause visual after-images or flash blindness in pilots on approach to either runway end at any time of day during any season of the year.
2. The FAA has reviewed the land use project and has issued a final Notice of Determination within which it raises no objections to the potential glare impacts of the project.

The FAA, in cooperation with the U.S. Department of Energy, has made available to the public a Solar Glare Analysis Tool that can be used to determine the potential for solar energy projects to cause glint and glare severe enough to interfere with the vision of pilots and controllers at airport traffic control towers.⁷ See Appendix B for information about this tool.

Policy A.7.2 Lighting

The following lighting systems are incompatible with this ALUCP when casting light toward the approach paths of aircraft:

- Searchlights
- Laser lights
- Sequenced flashing lights

⁷ <https://share.sandia.gov/phlux>

- Stroboscopic lights

Any other lighting systems that in the ALUC's determination produce effects that mimic airport identification lighting, runway end identification lighting, or runway approach lighting are also incompatible with this ALUCP.

Policy A.7.3 Sources of Dust, Water Vapor and Smoke

Land use projects that in the opinion of the ALUC may create columns of dust, steam, water vapor, or smoke dense enough to impair pilot vision and compromise flight safety are incompatible with this ALUCP.

Policy A.7.4 Electromagnetic Interference

Sources of electromagnetic interference with aircraft instrumentation and ground-based radar and navigational aids are incompatible with this ALUCP. If a land use project may result in electromagnetic interference, the ALUC must consult with the FAA to ensure that the FAA is aware of the potential for electronic interference. The ALUC must require the project sponsor to modify the land use project to comply with any FAA recommendations and conditions.

Policy A.7.5 Sources of Thermal Plumes

Land use projects that in the opinion of the ALUC may create thermal plumes with the potential to interfere with the safe control of aircraft are incompatible with this ALUCP. Thermal plumes rising 200 feet or more above the ground at upward velocities of 14.1 feet per second or greater are capable of jeopardizing the safe control of aircraft.

Policy A.7.6 Bird Attractants

The following land uses, if they have the potential to attract birds are incompatible with this ALUCP and are not permitted within the Airport Influence Area (AIA).⁸ See **Appendix G** for information regarding recorded bird strikes around airports in California.

1. Agricultural, recreational, open space activities and facilities that include:
 - (a) Aquaculture activities conducted outside of fully enclosed buildings

⁸ Federal Aviation Administration, Advisory Circular 150/5200-33B, *Hazardous Wildlife Attractants on or Near Airports*.

- (b) A water feature incorporated into landscaping, open space areas or golf courses are incompatible unless it is less than 2,500 square feet of surface area and measures are taken to control hazardous wildlife
- 2. Waste Disposal Operations
 - (a) Municipal solid waste landfills
 - (b) Trash transfer stations that handle waste, are not fully enclosed or that lack ventilation and air filtration systems adequate to control odors escaping to the outdoors (odor masking is not acceptable)
 - (c) Commercial or institutional composting operations that accept food waste
- 3. Water Management Facilities
 - (a) Storm water management facilities that create above-ground standing water, unless required by other provisions of municipal, county, or State law. Where storm water detention ponds are necessary and must be allowed, measures should be taken to minimize the risks of attracting potentially hazardous wildlife.
 - (b) Wastewater treatment facilities and associated settling ponds, including any devices and/or systems used to store, treat, recycle, or reclaim municipal sewage or liquid industrial wastes and artificial marshes designed for wastewater treatment.
 - (c) Wetlands mitigation projects, unless they provide unique functions that must remain onsite or are otherwise directed by state or federal law, state or federal regulatory decision, or court order.
 - (d) Dredge spoil containment areas (also known as confined disposal facilities) if the spoils contain material that would attract hazardous wildlife.

4.6 Avigation Easements

What is an Avigation Easement?

*An easement is a legal document that gives one entity the right to use a part of the real estate owned by another entity, but only as specified in the easement document. An avigation easement is a particular form of easement that may convey, for example, the right of passage over the property and the right to cause associated impacts including noise. See **Appendix B** for the SDIA avigation easement template.*

Policy A.8 Avigation Easement Dedication

A property owner must dedicate an avigation easement to the Airport operator if the land use project includes structures or objects exceeding the obstruction standards of Part 77, as determined by the FAA. An avigation easement is also required if the land use project is on a site where the existing ground level penetrates a Part 77 airspace surface.⁹

To ensure flight safety, all obstructions must remain clearly marked and visible to pilots. Any vegetation must be kept from growing into critical airspace. Therefore, avigation easements required under this policy must:

1. Provide the right of flight in the airspace above the property
2. Permit access to the property for the removal or aeronautical marking of objects exceeding the established FAA height limit
3. Permit access to the property for the maintenance of NAVAIDs
4. Require compliance with the criteria for the protection of flight safety established in **Policy A.7**

See **Appendix B** for the SDIA avigation easement template.

⁹ Civil airport imaginary surfaces are defined in accordance with the criteria described in Title 14, Code of Federal Regulations, Part 77, *Safe Efficient Use, and Preservation of the Navigable Airspace*, Subpart D, *Aeronautical Studies and Determinations*, §77.25.



CHAPTER 5

Overflight Compatibility Policies

Chapter 5 provides an overflight area boundary map for San Diego International Airport (SDIA or the Airport) and applicable policies relating to aircraft overflight notification.

Appendix E5 provides the technical basis for delineating the overflight area boundary and establishing the policies.

In addition to the policies and standards established by this chapter, a project sponsor must also review all policies and standards established by this ALUCP.

The policies of this chapter apply only to new development or redevelopment. The policies do not apply to existing land uses.

A list of the overflight compatibility policies is provided below.

Policy O.1	Overflight Boundary
Policy O.2	Overflight Notification

Overflight Compatibility Policies

Policy O.1 Overflight Boundary

The overflight boundary, as depicted on **Exhibit 5-1**, establishes the area where the policies of this chapter apply.

Policy O.2 Overflight Notification

An overflight notification agreement must be recorded with the Office of the County Recorder for any new dwelling unit within the overflight area indicated on **Exhibit 5-1**. The recordation of an overflight notification agreement is not necessary where the dedication of an avigation easement is required.

Alternative methods of providing overflight notification are acceptable if approved by the Airport Land Use Commission.

See **Appendix B** for a sample of an overflight notification agreement.



LEGEND

- Major Roads
- Highways
- - - Municipal Boundaries
- ▭ Airport Property Boundary
- · - · - San Diego Unified Port District Planning Jurisdiction Boundary
- ▭ Overflight Area Boundary: overflight notification is required for new residential development within the overflight area boundary.



Sources: San Diego Geographic Information Source (SanGIS), 2008 and 2011 (municipal boundaries, roads and highways); Ricondo & Associates, Inc., January 2012 (overflight area boundary).

Prepared by: Ricondo & Associates, Inc., October 2013.

Exhibit 5-1
Overflight Area Boundary

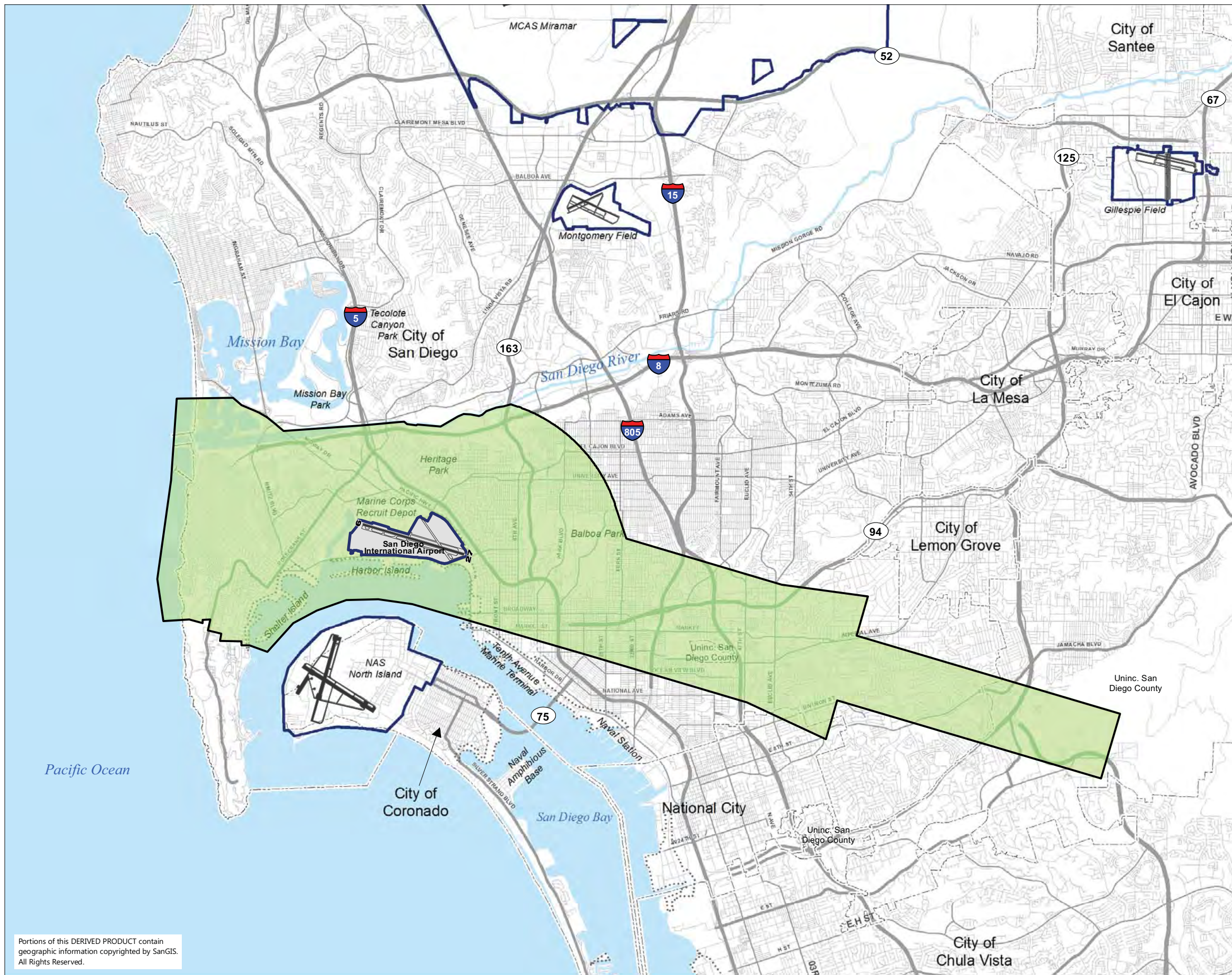

Portions of this DERIVED PRODUCT contain geographic information copyrighted by SanGIS. All Rights Reserved.



CHAPTER 6

Land Use Project Examples

This chapter describes a series of sample projects to help illustrate how consistency with this ALUCP is determined based on a review of all four compatibility factor policies and standards. Each project needs to be evaluated against each of the four compatibility factors and must be consistent with all applicable policies and standards to be deemed consistent with this ALUCP. This Chapter is a guide for project sponsors to use in determining the potential consistency of land use plans, regulations and projects with this ALUCP prior to local agency submittal. Following these steps would not replace the need for formal ALUC review in instances when ALUC review is required.

Example #1: New Residential Development

Project Description: Second dwelling unit (per State law) on a legal lot for an existing single-family residence in Loma Portal

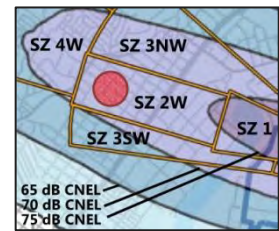

For Illustrative Purposes Only

AIRPORT INFLUENCE AREA

Based on Exhibit 1-1, is the project located inside the Airport Influence Area (AIA)?

- YES: Proceed to the next step.
- NO: The project is not subject to this ALUCP.

YES—The project is located within the AIA.

NOISE

Based on Exhibit 2-1, is the project located inside a noise contour?

- YES: Identify which noise range.
- NO: Proceed and assess consistency with the safety policies and standards of this ALUCP.

YES—The project is located inside the 70-75 dB CNEL noise range.

Based on Table 2-1 “Noise Compatibility Criteria,” a proposed land use may be:

- Compatible: the land use is permitted.
- Conditionally compatible: the land use is permitted subject to conditions. Refer to the “Exterior Noise Exposure” columns of **Table 2-1** and applicable footnotes.
- Incompatible: the land use is not permitted under any circumstances.

*Based on **Table 2-1**, the proposed land use is conditionally compatible. Per footnote 2, new residential use is allowed within the 70-75 dB CNEL contour if the General/Community Plan designation allows for residential use (areas depicted in yellow on **Exhibit 2-2**). The project is located on a parcel where residential use is allowed per **Exhibit 2-2**. For the land use category “Residential-Single Family, Multi-family” the conditions within the 70-75 dB CNEL noise range are:*

- *Building must be capable of attenuating exterior noise to 45 dB CNEL.*
- *An avigation easement must be granted to the Airport operator.*

Is the project consistent with the noise policies and standards of this ALUCP?

YES—If all conditions listed above are met.

SAFETY

Based on Exhibit 3-1, is the project located inside a safety zone?

- YES: Identify which safety zone and which Community Planning Area (CPA)/neighborhood.
- NO: Proceed and assess consistency with the airspace policies and standards of this ALUCP.

YES—The project is located inside Safety Zone 2W within the Peninsula CPA.

Based on Table 3-1 “Safety Compatibility Criteria,” a proposed land use may be:

- Compatible: the land use is permitted.
- Conditionally compatible: the land use is permitted subject to conditions. Refer to the “Conditions” column of **Table 3-1** to identify the applicable conditions.
- Incompatible: the land use is not permitted under any circumstances.

*Based on **Table 3-1**, the proposed land use is conditionally compatible. Under the land use category “Residential-Single Family, Multi-family”, residential use is allowed only in areas designated for residential use in the applicable Community Plan, up to the density limit of 20 dwelling units per acre in Safety Zone 2W in Peninsula – Other Neighborhoods.*

What is the proposed density of the project?

Not applicable: the project only includes the construction of a second dwelling unit for an existing single-family residence. Based on Policy S.4 of this ALUCP, second dwelling units, as defined by state law, are not included in calculating the density of a proposed land use project.

Is the project consistent with the safety policies and standards of this ALUCP?

YES— The project is located within an area where residential use is allowed and no density limitations apply.

AIRSPACE PROTECTION

Based on Exhibit 4-1, is the project located within the airspace protection boundary?

- YES: The project must comply with the airspace protection policies of this ALUCP.
- NO: Proceed and assess consistency with the overflight policies of this ALUCP. (The project may still be subject to FAA review based on the [Notice Criteria Tool](#) results and State airspace regulations.¹)

YES—The project is located within the airspace protection boundary.

Must the project sponsor notify the Federal Aviation Administration (FAA) of the project?

Using the FAA's online [Notice Criteria Tool](#), a project sponsor must enter project data in order to determine if FAA review is required.²

- YES: Notice is required. The project sponsor must file Form 7460-1 with the FAA. Proceed to the next step.
- NO: Notice is not required. Evaluate for hazards to air navigation.

NO—After entering the project information in the Notice Criteria Tool, it is determined that the project does not require notice to the FAA.

If notice is required, which determination has the FAA issued based on their review of Form 7460-1?

- A Determination of No Hazard (DNH) with a Does Not Exceed (DNE) status. The project does not exceed any obstruction standards and is consistent with the airspace policies of this ALUCP. Proceed to the next step.
- A Determination of No Hazard (DNH) with Marking and Lighting Requirements. The project exceeds an obstruction standard but is consistent with the airspace policies of this ALUCP if the FAA's stated conditions are met and if an aviation easement is granted to the Airport operator. Proceed to the next step.

¹ California Public Utilities Code §§21657, 21659(b); Title 14, Code of Federal Regulations, Part 77, *Safe, Efficient Use, and Preservation of the Navigable Airspace*, Subpart B, *Notice Requirements*, §77.9.

² Federal Aviation Administration, Department of Obstruction Evaluation/Airport Airspace Analysis (OE/AAA), *Notice Criteria Tool*, <https://oeaaa.faa.gov/oeaaa/external/gisTools/gisAction.jsp?action=showNoNoticeRequiredToolForm>.

- A Notice of Presumed Hazard (NPH): With such an FAA determination, the project is inconsistent with the airspace policies of this ALUCP and is not allowed. The sponsor may request FAA to undertake further aeronautical study of the proposed project.
- A Determination of Hazard (DOH): With such an FAA determination, the project is inconsistent with the airspace policies of this ALUCP and is not allowed unless the FAA determination is overruled by the local agency and a permit is issued by the state Department of Transportation.³

Not applicable because FAA review is not required.

Can the project potentially cause hazards to air navigation per Policy A.7 of this ALUCP (visual or instrument interference, wildlife attractants)?

- YES: The project sponsor must consult with the FAA, the ALUC and the Airport operator to resolve potential hazards to air navigation (see Policy A.7).
- NO: Proceed and assess consistency with the overflight policies of this ALUCP.

NO—The project does not include features potentially hazardous to air navigation.

Is the project consistent with the airspace protection policies and standards of this ALUCP?

YES—Notice to the FAA is not required and the project does not include features potentially hazardous to air navigation. Therefore, the project is consistent with the airspace policies and standards of this ALUCP.

OVERFLIGHT

Based on Exhibit 5-1, is the project located within the overflight area boundary?

- YES: The project must comply with the overflight policies of this ALUCP. Proceed to the next step.
- NO: The project is not subject to the overflight policies of this ALUCP.

YES—The project is located inside the overflight area boundary.

³ California Public Utilities Code §§21657, 21659(b).

Is the project a residential development?

- YES: Proceed to the next step.
- NO: The project is not subject to the overflight policies of this ALUCP.

YES—The project is a residential development.

For residential development, do the noise or airspace policies and standards require the granting of an avigation easement to the Airport operator?

- YES: The project is consistent with the overflight policies of this ALUCP.
- NO: Recording of an overflight agreement (or equivalent) is required for consistency with the overflight policies of this ALUCP.

YES—The project is a residential development and an avigation easement must be granted to comply with the noise policies of this ALUCP.

Is the project consistent with the overflight policies of this ALUCP?

YES—Recordation of an overflight agreement would typically be required, but since an avigation easement is also required for this project, the easement satisfies the overflight agreement recordation requirement. No separate overflight agreement needs to be recorded.

Is the project consistent with all policies and standards of this ALUCP?

YES, after assessing each compatibility factor separately, the project is determined to be consistent with all four compatibility factor policies and standards of this ALUCP, provided that the following conditions are met:

- *Building must be capable of attenuating exterior noise to 45 dB CNEL*
- *An avigation easement must be granted to the Airport operator to comply with the noise policies of this ALUCP*

Example #2: New Residential Development

Project Description: Condominium complex with 12 dwelling units, located on a 0.25 acre site

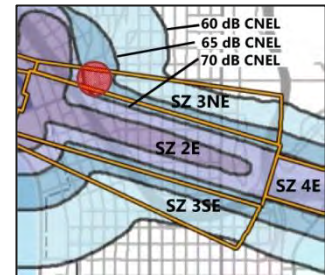

For Illustrative Purposes Only

AIRPORT INFLUENCE AREA

Based on Exhibit 1-1, is the project located inside the Airport Influence Area (AIA)?

- YES: Proceed to the next step.
- NO: The project is not subject to this ALUCP.

YES—The project is located within the AIA.

NOISE

Based on Exhibit 2-1, is the project located inside a noise contour?

- YES: Identify which noise range.
- NO: Proceed and assess consistency with the safety policies and standards of this ALUCP.

YES—The project is located inside the 65-70 dB CNEL noise range.

Based on Table 2-1 “Noise Compatibility Criteria,” a proposed land use may be:

- Compatible: the land use is permitted.
- Conditionally compatible: the land use is permitted subject to conditions. Refer to the “Exterior Noise Exposure” columns of **Table 2-1** and applicable footnotes.
- Incompatible: the land use is not permitted under any circumstances.

*Based on **Table 2-1**, the proposed land use is conditionally compatible. For the land use category “Residential-Single Family, Multi-family” the conditions within the 65-70 dB CNEL noise range are:*

- *Building must be capable of attenuating exterior noise to 45 dB CNEL.*
- *An aviation easement must be granted to the Airport operator.*

Is the project consistent with the noise policies and standards of this ALUCP?

YES—If all conditions listed above are met.

SAFETY

Based on Exhibit 3-1, is the project located inside a safety zone?

- YES: Identify which safety zone and which Community Planning Area (CPA)/neighborhood.
- NO: Proceed and assess consistency with the airspace policies and standards of this ALUCP.

YES—The project is located inside Safety Zone 3NE and within Uptown.

Based on Table 3-1 “Safety Compatibility Criteria,” a proposed land use may be:

- Compatible: the land use is permitted.
- Conditionally compatible: the land use is permitted subject to conditions. Refer to the “Conditions” column of **Table 3-1** to identify the applicable conditions.
- Incompatible: the land use is not permitted under any circumstances.

*Based on **Table 3-1**, the proposed land use is conditionally compatible. Under the land use category “Residential-Single Family, Multi-family”, residential use is allowed in areas designated for residential use in the applicable Community Plan, up to the density limit of 62 dwelling units per acre in Safety Zone 3NE in Uptown.*

What is the proposed density of the project?

12 dwelling units ÷ 0.25 acres = 48 dwelling units/acre

Is the project consistent with the safety policies and standards of this ALUCP?

YES—The density of the project is less than the density limit of 62 dwelling units per acre allowed in Safety Zone 3NE and Uptown.

AIRSPACE PROTECTION

Based on Exhibit 4-1, is the project located within the airspace protection boundary?

- YES: The project must comply with the airspace protection policies of this ALUCP.
- NO: Proceed and assess consistency with the overflight policies of this ALUCP. (The project may still be subject to FAA review based on the [Notice Criteria Tool](#) results and State airspace regulations.⁴)

YES—The project is located within the airspace protection boundary.

Must the project sponsor notify the Federal Aviation Administration (FAA) of the project?

Using the FAA's online [Notice Criteria Tool](#), a project sponsor must enter project data (latitude/longitude, site elevation and structure/object height) in order to determine if FAA review is required.⁵

- YES: Notice is required. The project sponsor must file Form 7460-1 with the FAA. Proceed to the next step.
- NO: Notice is not required. Evaluate for hazards to air navigation.

YES—After entering the project information in the Notice Criteria Tool, it is determined that the project requires notice to the FAA.

If notice is required, which determination has the FAA issued based on their review of Form 7460-1?

- A Determination of No Hazard (DNH) with a Does Not Exceed (DNE) status. The project does not exceed any obstruction standards and is consistent with the airspace policies of this ALUCP. Proceed to the next step.
- A Determination of No Hazard (DNH) with Marking and Lighting Requirements. The project exceeds an obstruction standard but is consistent with the airspace policies of this ALUCP if the FAA's stated conditions are met and if an aviation easement is granted to the Airport operator. Proceed to the next step.

⁴ California Public Utilities Code §§21657, 21659(b); Title 14, Code of Federal Regulations, Part 77, *Safe, Efficient Use, and Preservation of the Navigable Airspace*, Subpart B, *Notice Requirements*, §77.9.

⁵ Federal Aviation Administration, Department of Obstruction Evaluation/Airport Airspace Analysis (OE/AAA), *Notice Criteria Tool*, <https://oeaaa.faa.gov/oeaaa/external/gisTools/gisAction.jsp?action=showNoNoticeRequiredToolForm>.

- A Notice of Presumed Hazard (NPH): With such an FAA determination, the project is inconsistent with the airspace policies of this ALUCP and is not allowed. The sponsor may request FAA to undertake further aeronautical study of the proposed project.
- A Determination of Hazard (DOH): With such an FAA determination, the project is inconsistent with the airspace policies of this ALUCP and is not allowed unless the FAA determination is overruled by the local agency and a permit is issued by the state Department of Transportation.⁶

YES—The project required notice to the FAA and the FAA has issued a Determination of No Hazard with Marking and Lighting requirements.

Can the project potentially cause hazards to air navigation per Policy A.7 of this ALUCP (visual or instrument interference, wildlife attractants)?

- YES: The project sponsor must consult with the FAA, the ALUC and the Airport operator to resolve potential hazards to air navigation (see Policy A.7).
- NO: Proceed and assess consistency with the overflight policies of this ALUCP.

NO— The project does not include features potentially hazardous to air navigation.

Is the project consistent with the airspace protection policies and standards of this ALUCP?

YES—If the requirements contained in the FAA determination are met and an aviation easement is granted to the Airport operator.

OVERFLIGHT

Based on Exhibit 5-1, is the project located within the overflight area boundary?

- YES: The project must comply with the overflight policies of this ALUCP. Proceed to next step.
- NO: The project is not subject to the overflight policies of this ALUCP.

YES—The project is located inside the overflight area boundary.

⁶ California Public Utilities Code §§21657, 21659(b).

Is the project a residential development?

- YES: Proceed to the next step.
- NO: The project is not subject to the overflight policies of this ALUCP.

YES—The project is a residential development.

For residential development, do the noise or airspace policies and standards require the granting of an avigation easement to the Airport operator?

- YES: The project is consistent with the overflight policies of this ALUCP.
- NO: Recording of an overflight agreement (or equivalent) is required for consistency with the overflight policies of this ALUCP.

YES—The project is a residential development and avigation easements must be granted to comply with the noise and airspace policies of this ALUCP.

Is the project consistent with the overflight policies of this ALUCP?

YES— Recordation of an overflight agreement would typically be required, but since avigation easements are also required for this project, the easements satisfy the overflight agreement recordation requirement. No separate overflight agreement needs to be recorded.

Is the project consistent with all policies and standards of this ALUCP?

YES, after assessing each compatibility factor separately, the project is determined to be consistent with all four compatibility factor policies and standards of this ALUCP, provided that the following conditions are met:

- *The building must be capable of attenuating exterior noise to 45 dB CNEL.*
- *An avigation easement must be granted to the Airport operator to comply with the noise policies of this ALUCP.*
- *FAA marking and lighting requirements must be met.*
- *An avigation easement must be granted to the Airport operator to comply with the airspace policies of this ALUCP.*

Example #3: New Nonresidential Development

Project Description: Office and restaurant building in Little Italy, located on a 0.25 acre site

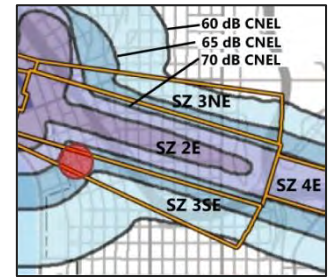

For Illustrative Purposes Only

AIRPORT INFLUENCE AREA

Based on Exhibit 1-1, is the project located inside the Airport Influence Area (AIA)?

- YES: Proceed to the next step.
- NO: The project is not subject to this ALUCP.

YES—The project is located within the AIA.

NOISE

Based on Exhibit 2-1, is the project located inside a noise contour?

- YES: Identify which noise range.
- NO: Proceed and assess consistency with the safety policies and standards of this ALUCP.

YES—The project is located inside the 65-70 dB CNEL noise range.

Based on Table 2-1 “Noise Compatibility Criteria,” a proposed land use may be:

- Compatible: the land use is permitted.
- Conditionally compatible: the land use is permitted subject to conditions. Refer to the “Exterior Noise Exposure” columns of **Table 2-1** and applicable footnotes.
- Incompatible: the land use is not permitted under any circumstances.

*Based on **Table 2-1**, the proposed land uses (office and restaurant) are compatible within the 65-70 dB CNEL noise range.*

Is the project consistent with the noise policies and standards of this ALUCP?

YES—The project is compatible with the noise policies and standards of this ALUCP.

SAFETY

Based on Exhibit 3-1, is the project located inside a safety zone?

- YES: Identify which safety zone and which Community Planning Area (CPA)/neighborhood.
- NO: Proceed and assess consistency with the airspace policies and standards of this ALUCP.

YES—The project is located inside Safety Zone 3SE in Little Italy.

Based on Table 3-1 “Safety Compatibility Criteria,” a proposed land use may be:

- Compatible: the land use is permitted.
- Conditionally compatible: the land use is permitted subject to conditions. Refer to the “Conditions” column of **Table 3-1** to identify the applicable conditions.
- Incompatible: the land use is not permitted under any circumstances.

*Based on **Table 3-1**, the proposed land uses (office and restaurant) are conditionally compatible. Under the land use categories “Office” and “Service-High Intensity”, development is allowed up to the intensity limit of 732 people per acre (in Safety Zone 3SE in Little Italy).*

What is the proposed intensity of the project?

*Based on **Table 3-1**, the occupancy factors for the “Office” and “Service High-Intensity” land uses are 215 and 60 sf/person, respectively.*

Office:

6,700 sf ÷ 215 sf/person = 31.2 office occupants

Restaurant:

1,300 sf ÷ 60 sf/person = 21.7 restaurant occupants

Total Occupants:

31.2 office occupants + 21.7 restaurant occupants = 52.9 total occupants

Intensity of the project:

52.9 total occupants ÷ 0.25 acres = 212 people/acre

Is the project consistent with the safety policies and standards of this ALUCP?

YES—The intensity of the project (212 people per acre) is less than the intensity limit of 732 people per acre allowed in Safety Zone 3SE in Little Italy.

AIRSPACE PROTECTION

Based on Exhibit 4-1, is the project located within the airspace protection boundary?

- YES: The project must comply with the airspace protection policies of this ALUCP.
- NO: Proceed and assess consistency with the overflight policies of this ALUCP. (The project may still be subject to FAA review based on the [Notice Criteria Tool](#) results and State airspace regulations.⁷)

YES—The project is located within the airspace protection boundary.

Must the project sponsor notify the Federal Aviation Administration (FAA) of the project?

Using the FAA's online [Notice Criteria Tool](#), a project sponsor must enter project data (latitude/longitude, site elevation and structure/object height) in order to determine if FAA review is required.⁸

- YES: Notice is required. The project sponsor must file Form 7460-1 with the FAA. Proceed to the next step.
- NO: Notice is not required. Evaluate for hazards to air navigation.

⁷ California Public Utilities Code §§21657, 21659(b); Title 14, Code of Federal Regulations, Part 77, *Safe, Efficient Use, and Preservation of the Navigable Airspace*, Subpart B, *Notice Requirements*, §77.9.

⁸ Federal Aviation Administration, Department of Obstruction Evaluation/Airport Airspace Analysis (OE/AAA), *Notice Criteria Tool*, <https://oeaaa.faa.gov/oeaaa/external/gisTools/gisAction.jsp?action=showNoNoticeRequiredToolForm>.

YES—After entering the project information in the Notice Criteria Tool, it is determined that the project requires notice to the FAA.

If notice is required, which determination has the FAA issued based on their review of Form 7460-1?

- A Determination of No Hazard (DNH) with a Does Not Exceed (DNE) status. The project does not exceed any obstruction standards and is consistent with the airspace policies of this ALUCP. Proceed to next step.
- A Determination of No Hazard (DNH) with Marking and Lighting Requirements. The project exceeds an obstruction standard but is consistent with the airspace policies of this ALUCP if the FAA's stated conditions are met and if an aviation easement is granted to the Airport operator. Proceed to next step.
- A Notice of Presumed Hazard (NPH): With such an FAA determination, the project is inconsistent with the airspace policies of this ALUCP and is not allowed. The sponsor may request FAA to undertake further aeronautical study of the proposed project.
- A Determination of Hazard (DOH): With such an FAA determination, the project is inconsistent with the airspace policies of this ALUCP and is not allowed unless the FAA determination is overruled by the local agency and a permit is issued by the state Department of Transportation.⁹

The FAA has issued a Determination of No Hazard (DNH) with a Does Not Exceed (DNE) status. The project does not exceed any obstruction standards.

Can the project potentially cause hazards to air navigation per Policy A.7 of this ALUCP (visual or instrument interference, wildlife attractants)?

- YES: The project sponsor must consult with the FAA, the ALUC and the Airport operator to resolve potential hazards to air navigation (see Policy A.7).
- NO: Proceed and assess consistency with the overflight policies of this ALUCP.

NO— The project does not include features potentially hazardous to air navigation.

⁹ California Public Utilities Code §§21657, 21659(b).

Is the project consistent with the airspace protection policies and standards of this ALUCP?

YES—The project is consistent with the airspace policies and standards of this ALUCP.

OVERFLIGHT

Based on Exhibit 5-1, is the project located within the overflight area boundary?

- YES: The project must comply with the overflight policies of this ALUCP. Proceed to the next step.
- NO: The project is not subject to the overflight policies of this ALUCP.

YES—The project is located inside the overflight area boundary.

Is the project a residential development?

- YES: Proceed to the next step.
- NO: The project is not subject to the overflight policies of this ALUCP.

NO—The project does not include residential development, and is therefore not subject to the overflight policies of this ALUCP.

For residential development, do the noise or airspace policies and standards require the granting of an aviation easement to the Airport operator?

- YES: The project is consistent with the overflight policies of this ALUCP.
- NO: Recording of an overflight agreement (or equivalent) is required for consistency with the overflight policies of this ALUCP.

Not applicable—The project does not include residential development.

Is the project consistent with the overflight policies of this ALUCP?

YES— The project does not include residential development and is therefore not subject to the overflight policies of this ALUCP.

Is the project consistent with all policies and standards of this ALUCP?

YES, after assessing each compatibility factor separately, the project is determined to be consistent with all four compatibility factor policies and standards of this ALUCP.

Example #4: Nonresidential Development in Existing Building

Project Description: Retail convenience market located in Uptown, with 2,000 square feet of floor area in an existing shopping center. The market would occupy space previously used for a tax preparation office.

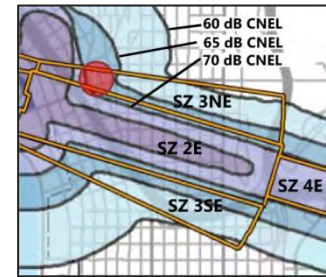

For Illustrative Purposes Only

AIRPORT INFLUENCE AREA

Based on Exhibit 1-1, is the project located inside the Airport Influence Area (AIA)?

- YES: Proceed to the next step.
- NO: The project is not subject to this ALUCP.

YES—The project is located within the AIA.

NOISE

Based on Exhibit 2-1, is the project located inside a noise contour?

- YES: Identify which noise range.
- NO: Proceed and assess consistency with the safety policies and standards of this ALUCP.

YES—The project is located inside the 60-65 dB CNEL noise range.

Based on Table 2-1 “Noise Compatibility Criteria,” a proposed land use may be:

- Compatible: the land use is permitted.
- Conditionally compatible: the land use is permitted subject to conditions. Refer to the “Exterior Noise Exposure” columns of **Table 2-1** and applicable footnotes.
- Incompatible: the land use is not permitted under any circumstances.

*Based on **Table 2-1**, the proposed land use (Retail-Medium Intensity) is compatible within the 60-65 dB CNEL noise range.*

Is the project consistent with the noise policies and standards of this ALUCP?

YES—The project is compatible with the noise policies and standards of this ALUCP.

SAFETY

Based on Exhibit 3-1, is the project located inside a safety zone?

- YES: Identify which safety zone and which Community Planning Area (CPA)/neighborhood.
- NO: Proceed and assess consistency with the airspace policies of this ALUCP.

YES—The project is located inside Safety Zone 3NE and within Uptown.

Based on Table 3-1 “Safety Compatibility Criteria,” a proposed land use may be:

- Compatible: the land use is permitted.
- Conditionally compatible: the land use is permitted subject to conditions. Refer to the “Conditions” column of **Table 3-1** to identify the applicable conditions.
- Incompatible: the land use is not permitted under any circumstances.

*Based on **Table 3-1**, the proposed land use is conditionally compatible. According to Policy S.12, new conditionally compatible uses are allowed in existing buildings without being subject to the intensity limits applying to new construction.*

Is the project consistent with the safety policies and standards of this ALUCP?

YES—As a conditionally compatible use proposed in an existing building, the proposed use is allowable in Safety Zone 3NE and is consistent with the ALUCP

AIRSPACE PROTECTION

Based on Exhibit 4-1, is the project located within the airspace protection boundary?

- YES: The project must comply with the airspace protection policies of this ALUCP.
- NO: Proceed and assess consistency with the overflight policies of this ALUCP. (The project may still be subject to FAA review based on the [Notice Criteria Tool](#) results and State airspace regulations.¹⁰)

YES—The project is located within the airspace protection boundary.

Must the project sponsor notify the Federal Aviation Administration (FAA) of the project?

Using the FAA's online [Notice Criteria Tool](#), a project sponsor must enter project data (latitude/longitude, site elevation and structure/object height) in order to determine if FAA review is required.¹¹

- YES: Notice is required. The project sponsor must file Form 7460-1 with the FAA. Proceed to the next step.
- NO: Notice is not required. Evaluate for hazards to air navigation.

NO—Notice is not required. Only interior modifications are being made to the building. Exterior changes involve only new windows, doors, and signs, which are not subject to FAA review.

If notice is required, which determination has the FAA issued based on their review of Form 7460-1?

- A Determination of No Hazard (DNH) with a Does Not Exceed (DNE) status. The project does not exceed any obstruction standards and is consistent with the airspace policies of this ALUCP. Proceed to next step.
- A Determination of No Hazard (DNH) with Marking and Lighting Requirements. The project exceeds an obstruction standard but is consistent with the airspace policies of this ALUCP if the FAA's stated conditions are met and if an aviation easement is granted to the Airport operator. Proceed to next step.

¹⁰ California Public Utilities Code §§21657, 21659(b); Title 14, Code of Federal Regulations, Part 77, *Safe, Efficient Use, and Preservation of the Navigable Airspace*, Subpart B, *Notice Requirements*, §77.9.

¹¹ Federal Aviation Administration, Department of Obstruction Evaluation/Airport Airspace Analysis (OE/AAA), *Notice Criteria Tool*, <https://oeaaa.faa.gov/oeaaa/external/gisTools/gisAction.jsp?action=showNoNoticeRequiredToolForm>.

- A Notice of Presumed Hazard (NPH): With such an FAA determination, the project is inconsistent with the airspace policies of this ALUCP and is not allowed. The sponsor may request FAA to undertake further aeronautical study of the proposed project.
- A Determination of Hazard (DOH): With such an FAA determination, the project is inconsistent with the airspace policies of this ALUCP and is not allowed unless the FAA determination is overruled by the local agency and a permit is issued by the state Department of Transportation.¹²

Not applicable because FAA review is not required.

Can the project potentially cause hazards to air navigation per Policy A.7 of this ALUCP (visual or instrument interference, wildlife attractants)?

- YES: The project sponsor must consult with the FAA, the ALUC and the Airport operator to resolve potential hazards to air navigation (see Policy A.7).
- NO: Proceed and assess consistency with the overflight policies of this ALUCP.

NO— The project does not include features potentially hazardous to air navigation.

Is the project consistent with the airspace protection policies and standards of this ALUCP?

YES—The project is consistent with the airspace protection policies and standards of this ALUCP.

OVERFLIGHT

Based on Exhibit 5-1, is the project located within the overflight area boundary?

- YES: The project must comply with the overflight policies of this ALUCP. Proceed to the next step.
- NO: The project is not subject to the overflight policies of this ALUCP.

YES—The project is located inside the overflight area boundary.

¹² California Public Utilities Code §§21657, 21659(b).

Is the project a residential development?

- YES: Proceed to the next step.
- NO: The project is not subject to the overflight policies of this ALUCP.

NO—The project does not include residential development, and is therefore not subject to the overflight policies of this ALUCP.

For residential development, do the noise or airspace policies and standards require the granting of an aviation easement to the Airport operator?

- YES: The project is consistent with the overflight policies of this ALUCP.
- NO: Recording of an overflight agreement (or equivalent) is required for consistency with the overflight policies of this ALUCP.

Not applicable—The project does not include residential development.

Is the project consistent with the overflight policies of this ALUCP?

YES— The project does not include residential development and is therefore not subject to the overflight policies of this ALUCP.

Is the project consistent with all policies and standards of this ALUCP?

YES, after assessing each compatibility factor separately, the project is determined to be consistent with all four compatibility factor policies and standards of this ALUCP.

Example #5: New Mixed-Use Development

Project Description: Office/retail/residential building located in Uptown

- 3,200 sf office
- 2,000 sf retail
- 5 dwelling units
- 10,000 sf (0.23 ac.) site area

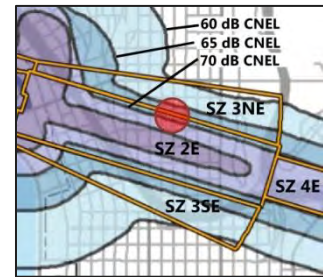

For Illustrative Purposes Only

AIRPORT INFLUENCE AREA

Based on Exhibit 1-1, is the project located inside the Airport Influence Area (AIA)?

- YES: Proceed to the next step.
- NO: The project is not subject to this ALUCP.

YES—The project is located within the AIA.

NOISE

Based on Exhibit 2-1, is the project located inside a noise contour?

- YES: Identify which noise range.
- NO: Proceed and assess consistency with the safety policies and standards of this ALUCP.

YES—The project is located inside the 65-70 dB CNEL noise range.

Based on Table 2-1 “Noise Compatibility Criteria,” a proposed land use may be:

- Compatible: the land use is permitted.
- Conditionally compatible: the land use is permitted subject to conditions. Refer to the “Exterior Noise Exposure” columns of **Table 2-1** and applicable footnotes.
- Incompatible: the land use is not permitted under any circumstances.

Based on **Table 2-1**, within the 65-70 dB CNEL noise range, the proposed land uses are as follows:

- Office: Compatible
- Retail-Medium Intensity: Compatible
- Residential-Multi Family: Conditionally Compatible, with the following conditions:
 - Building must be capable of attenuating exterior noise in the residential dwelling to 45 dB CNEL.
 - An aviation easement must be granted to the Airport operator.

Is the project consistent with the noise policies and standards of this ALUCP?

YES—If all conditions listed above for the residential development component of the project are met.

SAFETY

Based on Exhibit 3-1, is the project located inside a safety zone?

- YES: Identify which safety zone and which Community Planning Area (CPA)/neighborhood.
- NO: Proceed and assess consistency with the airspace policies of this ALUCP.

YES—The project is located inside Safety Zone 2E within Uptown.

Based on Table 3-1 “Safety Compatibility Criteria,” a proposed land use may be:

- Compatible: the land use is permitted.
- Conditionally compatible: the land use is permitted subject to conditions. Refer to the “Conditions” column of **Table 3-1** to identify the applicable conditions.
- Incompatible: the land use is not permitted under any circumstances.

Based on **Table 3-1**, within Safety Zone 2E in Uptown, the proposed land uses are conditionally compatible, as follows:

- Office: Development in the Uptown portion of SZ 2E normally is allowed up to the intensity limit of 272 people per acre. Because this is a mixed-use project, however, the maximum allowable intensity must be adjusted to account for the equivalent intensity of the residential portion of the project.
- Retail-Medium Intensity: Development is allowed up to the adjusted intensity limit described above for the office portion of the project.
- Residential-Multi Family: Residential use is allowed in areas designated for residential use in the applicable Community Plan, up to the density limit of 40 dwelling units per acre in SZ 2E (per Table 3-1).

What are the proposed density and intensity of the project?

Residential Development Component:

Residential Density and Intensity of the project:

$5 \text{ dwelling units} \div 0.23 \text{ acres} = 22 \text{ dwelling units/acre}$

Convert the residential density to intensity by multiplying the dwelling units per acre by the persons per household (PPH) for SZ 2E per **Table 3-1**.

$22 \text{ dwelling units} \times 1.51 \text{ PPH} = 33.2 \text{ people per acre}$, which is rounded to 33 people per acre.

Nonresidential Development Component:

Nonresidential Intensity of the project:

Based on **Table 3-1**, the occupancy factors for "Office" and "Retail-Medium Intensity" land use categories are 215 and 170 sf/person, respectively.

Office: $3,200 \text{ sf} \div 215 \text{ sf/person} = 14.9 \text{ occupants}$

Retail: $2,000 \text{ sf} \div 170 \text{ sf/person} = 11.8 \text{ occupants}$

Total occupants: $14.9 + 11.8 = 26.7 \text{ occupants}$

$26.7 \text{ occupants} \div 0.22 \text{ acres} = 121 \text{ people per acre}$

The nonresidential intensity of the project is 121 people per acre.

Sum total of the project's residential and nonresidential intensities:

The sum total of the project's residential and nonresidential intensities cannot exceed the allowed intensity limit identified in **Table 3-1** (272 people per acre). The sum total of the project's residential and nonresidential intensities is $33 + 121 = 154 \text{ people per acre}$.

Calculation of Adjusted Maximum Allowable Intensity:

As an optional interim step, an adjusted maximum allowable intensity could be calculated in order to identify the intensity (people per acre) remaining available for the nonresidential development component after the residential density has been converted into intensity.

The adjusted maximum intensity is equal to the maximum intensity noted in **Table 3-1** (272 people per acre) less the equivalent intensity of the residential dwelling units in the mixed-use project.

Maximum intensity allowed per **Table 3-1** = 272

Equivalent residential intensity = 33

Adjusted maximum allowable intensity = $272 - 33 = 249$

Therefore, the project sponsor could plan for the intensity of the nonresidential development component to reach a maximum of 249 people per acre while ensuring that the project remains consistent with the safety policies and standards of this ALUCP.

Is the project consistent with the safety policies and standards of this ALUCP?

YES—The density of the project is less than the density limit of 40 dwelling units per acre (per Table 3-1) and the sum total of the project's residential and nonresidential intensities is 154 people per acre, which is less than the allowable maximum of 272 people per acre.

AIRSPACE PROTECTION**Based on Exhibit 4-1, is the project located within the airspace protection boundary?**

- YES: The project must comply with the airspace protection policies of this ALUCP.
- NO: Proceed and assess consistency with the overflight policies of this ALUCP. (The project may still be subject to FAA review based on the [Notice Criteria Tool](#) results and State airspace regulations.¹³)

YES—The project is located within the airspace protection boundary.

Must the project sponsor notify the Federal Aviation Administration (FAA) of the project?

¹³ California Public Utilities Code §§21657, 21659(b); Title 14, Code of Federal Regulations, Part 77, *Safe, Efficient Use, and Preservation of the Navigable Airspace*, Subpart B, *Notice Requirements*, §77.9.

Using the FAA's online [Notice Criteria Tool](#), a project sponsor must enter project data (latitude/longitude, site elevation and structure/object height) in order to determine if FAA review is required.¹⁴

- YES: Notice is required. The project sponsor must file Form 7460-1 with the FAA. Proceed to the next step.
- NO: Notice is not required. Evaluate for hazards to air navigation.

YES—After entering the project information in the Notice Criteria Tool, it is determined that the project requires notice to the FAA.

If notice is required, which determination has the FAA issued based on their review of Form 7460-1?

- A Determination of No Hazard (DNH) with a Does Not Exceed (DNE) status. The project does not exceed any obstruction standards and is consistent with the airspace policies of this ALUCP. Proceed to the next step.
- A Determination of No Hazard (DNH) with Marking and Lighting Requirements. The project exceeds an obstruction standard but is consistent with the airspace policies of this ALUCP if the FAA's stated conditions are met and if an aviation easement is granted to the Airport operator. Proceed to the next step.
- A Notice of Presumed Hazard (NPH): With such an FAA determination, the project is inconsistent with the airspace policies of this ALUCP and is not allowed. The sponsor may request FAA to undertake further aeronautical study of the proposed project.
- A Determination of Hazard (DOH): With such an FAA determination, the project is inconsistent with the airspace policies of this ALUCP and is not allowed unless the FAA determination is overruled by the local agency and a permit is issued by the state Department of Transportation.¹⁵

The FAA has issued a Determination of No Hazard (DNH) with a Does Not Exceed (DNE) status. The project does not exceed any obstruction standards.

Can the project potentially cause hazards to air navigation per Policy A.7 of this ALUCP (visual or instrument interference, wildlife attractants)?

¹⁴ Federal Aviation Administration, Department of Obstruction Evaluation/Airport Airspace Analysis (OE/AAA), *Notice Criteria Tool*, <https://oeaaa.faa.gov/oeaaa/external/gisTools/gisAction.jsp?action=showNoNoticeRequiredToolForm>.

¹⁵ California Public Utilities Code §§21657, 21659(b).

- YES: The project sponsor must consult with the FAA, the ALUC and the Airport operator to resolve potential hazards to air navigation (see Policy A.7).
- NO: Proceed and assess consistency with the overflight policies of this ALUCP.

NO—The project does not include features potentially hazardous to air navigation.

Is the project consistent with the airspace protection policies and standards of this ALUCP?

YES—The project is consistent with the airspace policies and standards of this ALUCP.

OVERFLIGHT

Based on Exhibit 5-1, is the project located within the overflight area boundary?

- YES: The project must comply with the overflight policies of this ALUCP. Proceed to the next step.
- NO: The project is not subject to the overflight policies of this ALUCP.

YES—The project is located inside the overflight area boundary.

Is the project a residential development?

- YES: Proceed to the next step.
- NO: The project is not subject to the overflight policies of this ALUCP.

YES—The project includes residential development.

For residential development, do the noise or airspace policies and standards require the granting of an aviation easement to the Airport operator?

- YES: The project is consistent with the overflight policies of this ALUCP.
- NO: Recording of an overflight agreement (or equivalent) is required for consistency with the overflight policies of this ALUCP.

YES—The project includes residential development and an aviation easement must be granted to comply with the noise policies of this ALUCP.

Is the project consistent with the overflight policies of this ALUCP?

YES— Recordation of an overflight agreement would typically be required, but since an aviation easement is also required for this project, the easement satisfies the overflight agreement recordation requirement. No separate overflight agreement needs to be recorded.

Is the project consistent with all policies and standards of this ALUCP?

YES, after assessing each compatibility factor separately, the project is determined to be consistent with all four compatibility factor policies and standards of this ALUCP, provided that the following conditions are met:

- *The building must be capable of attenuating exterior noise to 45 dB CNEL.*
- *An aviation easement must be granted to the Airport operator to comply with the noise policies of this ALUCP.*





AIRPORT LAND USE COMMISSION
San Diego County Regional Airport Authority

San Diego International Airport

AIRPORT LAND USE
COMPATIBILITY PLAN

FEBRUARY 2014



APPENDICES



APPENDIX A

Land Use Classification Definitions

This appendix provides definitions of land uses listed in the noise and safety compatibility standards tables (**Tables 2-1** and **3-1**). These definitions were adapted from various sources including San Diego Association of Governments (SANDAG), the American Planning Association (APA), and the City of San Diego Municipal Code.

Other sources of guidance on land use classification include:

- American Planning Association, *Land-Based Classification Standards*, <http://www.planning.org/lbcs>.
- U.S. Department of Labor, Bureau of Labor Statistics, North American Industry Classification System (NAICS) <http://www.bls.gov/bls/naics.htm>.
- S. Mark White, *Classifying and Defining Uses and Building Forms: Land-Use Coding for Zoning Regulations*, *Zoning Practice*, No. 9, American Planning Association, September 2005.
- U.S. Urban Renewal Administration, Bureau of Public Roads. *Standard Land Use Coding Manual*, U.S. Government Printing Office, 1965.

RESIDENTIAL

Single-Family Residential

Includes single-family detached and attached housing units, such as townhomes, on individual lots. Newer developments may include clubhouses, recreation areas, pools, tennis, etc. located within and associated with the residential development, if a separate parcel/lot designation does not exist.

Multi-Family Residential

Multi-family attached units such as apartment homes, condominium and townhome developments.

Single Room Occupancy (SRO) Facility

An establishment that provides small fully furnished rooms, with utilities included, for rent on daily, weekly and monthly terms.

Group Quarters

Facilities where people live together and share a common kitchen on a more than temporary basis such as college dorms, group homes, half-way houses, monasteries and prisons. This does not include nursing homes or congregate care facilities. If this use would occur within a single- or multi-family residence, it must be evaluated as a single- or multi-family residential use.

COMMERCIAL, OFFICE, SERVICE, TRANSIENT LODGING

Hotel, Motel, Resort

Establishments that provide accommodations, meals and other services for travelers and tourists. They may also include conference rooms and similar facilities. Resorts usually include recreation areas in addition to hotel accommodations.

Office—Medical, Financial, Professional Services, Civic

Buildings that provide banking, business, civic and professional services. Examples include:

- Medical Offices: Buildings that provide uses related to the diagnosis and treatment of human illness and physical malfunction that can be performed in an office setting, including doctor's and dentist's offices. This includes out-patient clinics.
- Financial Institutions: Buildings that provide uses related to the exchange, lending, borrowing and safe-keeping of money.
- Professional Services: Buildings that provide uses related to the practice of a vocation requiring specialized training or education, including insurance, architecture, engineering, law offices, accounting, etc.
- Civic: Buildings that provide uses related to the delivery of government and public services, including city halls, post offices, court houses, chambers of commerce, charitable organizations, etc.

Retail

Establishments for the retail sale of goods that require moderate-sized to compact areas for the display and storage of products relative to the number of shoppers at the establishment. Examples include:

- Convenience Markets: A store or food mart (except those with fuel pumps) that primarily retails a limited line of goods that generally includes milk, bread, soda and snacks. In high traffic or tourism corridors, they also sell gifts, crafts, maps and other goods normally associated with travel and tourism.
- Drugstores: Pharmacies and drug stores that primarily retail prescription or nonprescription drugs and medicines. They may also sell convenience items and sundries.
- Pet Stores: This category includes establishments selling household pets and pet supplies. These establishments may provide animal services, such as grooming and training.
- Specialty Retail Sales: Establishments for the sale of clothing, shoes, toys, jewelry, gifts, etc.

Service—Low-Intensity (e.g., Auto Service Station, Car Wash)

Establishments providing services to the public that require large work/equipment storage areas relative to the number of customers. Examples include gas stations, auto repair and car wash. The typical functions of these establishments include the sales of gasoline, auto parts, auto repairs, tires and other auto-related merchandise. It also includes an area or structure equipped with facilities for washing automobiles, service garages and other structures that have bays for automobile service. These are specialized structures for auto repair and service. Also includes car rental services.

Service—Medium-Intensity (e.g., Check-cashing, Veterinary Clinics, Kennels, Personal Services)

Establishments providing services to the public that require relatively large work and equipment storage areas relative to the number of customers at the establishment. Examples include:

- Check-cashing: Facility dedicated to cashing checks for a fee as a principal business activity.
- Veterinary Clinics: Establishments with licensed practitioners of veterinary medicine, dentistry or surgery for animals; also included are establishments that provide testing services for licensed veterinary practitioners.
- Mortuary Services: Uses that provide services related to the death of a human, but that do not include on-site funeral chapels and assembly rooms.

- Kennels: Establishments for the breeding or boarding of dogs or cats.
- Personal Services: Hair salons, barber shops, spas, etc.

Service—High Intensity (e.g., Eating, Drinking Establishment, Funeral Chapel, Mortuary)

Establishments providing services to the public that require relatively small work and equipment storage areas relative to the number of customers at the establishment. Examples include:

- Eating, Drinking Establishments: Uses that prepare or serve food or beverages for consumption on the premises or for direct sale to the public for consumption off the premises.
- Funeral and Mortuary Services: Uses that provide services related to the death of a human and that have on-site funeral chapels and assembly rooms.

Sport/Fitness Facility

Areas for indoor sports and fitness activities, including court sports (basketball, tennis, volleyball and racquetball) and other activities for adults over 18 years of age (e.g. gymnastics, wrestling, swimming, exercise, yoga, aerobics, and dance instruction).

Theater—Movie/Live Performance/Dinner

- Movie Theaters: Specialized theaters for showing movies or motion pictures. This category also includes cineplexes-- structures with multiple movie theaters, each theater capable of providing performances independent of the others in the complex.
- Theaters for Live Performance: Concert halls and theaters intended for stage productions.
- Dinner theaters: Establishments in which meals are served during or after live performance plays.

EDUCATIONAL, INSTITUTIONAL, PUBLIC SERVICES

Assembly – Adults (Religious, Fraternal, Other)

An establishment for a mass assembly of people for social, cultural, or religious purposes. Examples include:

- Religious Facility: These establishments operate religious organizations, such as churches, temples, monasteries, synagogues, etc.
- Fraternal Lodge: These are establishments that promote the interests of their members or particular social or charitable causes.

- Other Meeting Places: These include labor halls and other places of assembly for professional or political organizations and associations.

Assembly – Children (Instructional Studios, Cultural Heritage Schools, Religious, Other)

An establishment for the assembly of children (age 0-18 years, regardless of the amount of time spent on the premises), for educational, social, cultural, or recreational purposes. These establishments do not include nurseries, pre-k schools, child day care centers or K-12 [charter schools](#). Examples include:

- Instructional Studios: These are establishments that provide classes of any type, including recreational, artistic, dance, etc.
- Cultural Heritage Schools: These are establishments that provide specialized instruction, tutoring, classes, etc. for a particular culture or religion.
- Other Meeting Places: These include places of assembly for children for religious or other organizational purposes.

Cemetery

Land that is specifically designated as a burial ground where the remains of deceased people are buried or are otherwise interred.

Child Day Care Center/Pre-K

Facility, other than a family day care home, in which less than 24-hours per day of nonmedical care and supervision are provided to children in a group setting. Includes employer-sponsored centers. This category also includes nursery and pre-kindergarten schools.

Convention Center

Convention structures have both an exhibition hall and a number of meeting rooms. Many also have kitchen and banquet facilities and an auditorium for special events. Trade shows, public shows, conventions, food functions, receptions, dances, banquets, assemblies and other activities are typically hosted in these structures.

Fire and Police Stations

- Fire Station: Fire and rescue establishments engage in firefighting and other related fire protection activities. These establishments may also provide fire protection along with ambulance or rescue services.
- Police Station: Police establishments provide criminal and civil law enforcement, police, traffic safety and other activities related to the enforcement of the law and preservation of order. Combined police and fire departments are included.

Jail, Prison

These government establishments manage and operate correctional institutions. Their facilities are generally designed for the confinement, correction and rehabilitation of offenders sentenced by a court.

Library, Museum, Gallery

- **Library:** An establishment providing library or archive services engaged in maintaining collections of documents (e.g., books, journals, newspapers and music) and facilitating the use of such documents (recorded information regardless of its physical form and characteristics) as are required to meet the informational, research, educational or recreational needs of their users. These establishments may also acquire, research, store, preserve and generally make accessible to the public historical documents, photographs, maps, audio material, audiovisual material and other archival material of historical interest. All or portions of these collections may be accessible electronically.
- **Museum:** These establishments preserve and exhibit objects of artistic, historical, cultural or educational value.
- **Gallery:** A use established for the purpose of public exhibitions of works of art.

Medical Care – Congregate Care Facility, Nursing and Convalescent Home

An establishment for the professional treatment of an illness or injury. Examples include:

- **Congregate Care Facility:** Establishments providing meals and other services in low-income and federally subsidized housing. Many establishments now provide such services to other non-subsidized housing facilities. Services include housekeeping, laundry, transportation, recreational programs and other convenience services.
- **Nursing Facility/Convalescent Home:** Establishments providing inpatient nursing and rehabilitative services and accommodating patients for extended care. These establishments have licensed health care staff serving patients and other support staff for continuous personal care services. Convalescent homes/hospitals, inpatient care hospices, nursing homes and rest homes with nursing care are a few examples of services these establishments provide.

If these uses would occur within a single- or multi-family residence, they must be evaluated as a single- or multi-family residential use.

Medical Care – Hospital

Hospitals provide medical, diagnostic and treatment services. These establishments often offer physician, nursing and specialized accommodation services for inpatient care.

Medical Care – Out-Patient Surgery Centers

Health care facilities where surgical procedures not requiring an overnight hospital stay are performed.

School for Adults – College, University, Vocational/Trade School

These establishments furnish academic or technical courses and grant degrees, certificates or diplomas at the associates, baccalaureate or graduate levels. It also includes trade or vocational schools.

School – Kindergarten through Grade 12

These establishments include charter, elementary, junior high, middle and senior high schools. Elementary schools usually include the first four to the first eight grades and often a kindergarten. A middle school usually includes grades five to eight or six to eight, and a senior high school includes grades nine to twelve or ten to twelve. These establishments do not include nursery or pre-k schools or child day care centers.

INDUSTRIAL

Junkyard, Dump, Recycling Center, Construction Yard

- Junkyard: A yard used to store junk that may be sold.
- Dump: An accumulation of refuse and discarded materials; or a quantity of reserve materials accumulated at one place, not including sanitary landfills.
- Recycling Centers: Facility for the collection and processing of recyclable materials.
- Construction Yards: Places for the permanent or temporary storage of construction equipment and supplies, including vehicles.

Manufacturing/Processing – General

Uses that process, fabricate, assemble treat or package finished parts or products without the use of explosive or petroleum materials.

Manufacturing/Processing of Biomedical Agents, Biosafety Levels 3 and 4 Only

Any facility for biomedical processing or research where dangerous or exotic agents requiring a Biosafety Level 3 or 4 environment are present.¹

¹ Biosafety Level 3 facilities handle agents that cause serious or potentially lethal disease through inhalation. Biosafety Level 4 facilities handle agents that cause life-threatening disease and for which there are no vaccines or treatments. U.S. Department of Health and Human Services, Centers for Disease Control and Prevention, and National Institutes of Health, *Biosafety in Microbiological and Biomedical Laboratories*, December 2009.

Manufacturing/Processing of Hazardous Materials

Facilities where hazardous materials are manufactured or processed. Hazardous materials are defined by the U.S. Environmental Protection Agency (EPA) as “substances that are considered severely harmful to human health and the environment.”² In this ALUCP, facilities involving hazardous materials include:

- Facilities with aboveground storage tanks containing any of the following materials:
 - Flammable or combustible liquids, including fuels or other substances containing at least 5 percent petroleum, with individual tanks having a capacity greater than 6,000 gallons or total tank capacities greater than 12,000 gallons.³
 - Liquefied petroleum, hydrogen and natural gases and cryogenic liquids with an individual tank capacity equivalent to 2,000 gallons of water or total tank capacities greater than 30,000 gallons.⁴
 - Compressed gases in excess of 50,000 cubic feet on the premises.⁵
- Facilities involving the manufacturing or processing of toxic substances exceeding the threshold planning quantities for hazardous and extremely hazardous substances specified by the EPA⁶
- Facilities involving the manufacturing or processing of explosive materials, including fireworks, in quantities exceeding 50 pounds⁷
- Medical and biological research facilities manufacturing or processing toxic or infectious agents that are classified as Biosafety Level 2 facilities⁸

Mining, Extractive Industry

Industries engaged with the discovery or extraction of natural resources.

² U.S. Environmental Protection Agency, Comprehensive Environmental Response, Compensation, and Liability Act (CERCLA), <http://www.epa.gov/osweroe1/content/hazsubs/cercsubs.htm>, accessed January 12, 2012.

³ Based on building separation criteria from the National Fire Protection Association, NFPA 1, *Fire Code*, 2012 Edition, Chapter 42, Table 42.3.3.2.4.

⁴ Based on building separation criteria from the National Fire Protection Association, NFPA 1, *Fire Code*, 2012 Edition, Chapter 69, Table 69.3.3.1.

⁵ Based on building separation criteria from the National Fire Protection Association, NFPA 1, *Fire Code*, 2012 Edition, Chapter 63, Tables 63.3.6.2, 63.3.7.2.

⁶ Title 40, Code of Federal Regulations, Part 355, *Emergency Planning and Preparation*, Appendices A and B.

⁷ California Code of Regulations, Title 8, Subchapter 7 *General Industry Safety Orders*, Group 18 *Explosives and Pyrotechnics*, Article 114 *Storage of Explosives*.

⁸ Biosafety Level 2 facilities handle agents that pose moderate hazards to personnel and the environment. U.S. Department of Health and Human Services, Centers for Disease Control and Prevention, and National Institutes of Health, *Biosafety in Microbiological and Biomedical Laboratories*, December 2009. (Biosafety Level 1 does not involve hazardous materials.)

Research and Development – Scientific, Technical

Uses engaged in scientific and technical research and testing leading to the development of new products and processes.

Sanitary Landfill

Landfills for the disposal of nonhazardous solid waste. These may include on-site offices and equipment storage supporting the local waste collection process. These establishments also manage recycling and resource recovery facilities that operate in conjunction with landfills.

Self-storage Facility

Public self-storage buildings, including recreational vehicle (RV) storage.

Warehousing/Storage – General

Uses engaged in long-term and short-term storage of goods in bulk, but not including self-storage facilities.

Warehousing/Storage of Biomedical Agents, Biosafety Levels 3 and 4 Only

Any facility storing dangerous or exotic agents requiring a biosafety level 3 or 4 environment.⁹

Warehousing/Storage of Hazardous Materials

Facility for the storage of hazardous materials. Hazardous materials are defined by the EPA as “substances that are considered severely harmful to human health and the environment.”¹⁰ In this ALUCP, facilities involving hazardous materials include:

- Facilities with aboveground storage tanks containing any of the following materials:
 - Flammable or combustible liquids, including fuels or other substances containing at least 5 percent petroleum, with individual tanks having a capacity greater than 6,000 gallons or total tank capacities greater than 12,000 gallons.¹¹
 - Liquefied petroleum, hydrogen and natural gases and cryogenic liquids with an individual tank capacity equivalent to 2,000 gallons of water or total tank capacities greater than 30,000 gallons.¹²

⁹ Biosafety Level 3 facilities handle agents that cause serious or potentially lethal disease through inhalation. Biosafety Level 4 facilities handle agents that cause life-threatening disease and for which there are no vaccines or treatments. U.S. Department of Health and Human Services, Centers for Disease Control and Prevention, and National Institutes of Health, *Biosafety in Microbiological and Biomedical Laboratories*, December 2009.

¹⁰ U.S. Environmental Protection Agency, Comprehensive Environmental Response, Compensation, and Liability Act (CERCLA), <http://www.epa.gov/osweroe1/content/hazsubs/cercsubs.htm>, accessed January 12, 2012.

¹¹ Based on building separation criteria from the National Fire Protection Association, NFPA 1, *Fire Code*, 2012 Edition, Chapter 42, Table 42.3.3.2.4.

¹² Based on building separation criteria from the National Fire Protection Association, NFPA 1, *Fire Code*, 2012 Edition, Chapter 69, Table 69.3.3.1.

- Compressed gases in excess of 50,000 cubic feet on the premises.¹³
- Facilities involving the warehousing or storage of toxic substances exceeding the threshold planning quantities for hazardous and extremely hazardous substances specified by the EPA¹⁴
- Facilities involving the warehousing or storage of explosive materials, including fireworks, in quantities exceeding 50 pounds¹⁵
- Medical and biological research facilities storing toxic or infectious agents that are classified as Biosafety Level 2 facilities¹⁶

TRANSPORTATION, COMMUNICATION, UTILITIES

Auto Parking

Parking lots including surface lots, parking structures and park and ride lots not associated with another land use.

Electrical Power Generation Plant

Establishment generating electrical power, including associated control facilities, distribution centers, and other facilities.

Electrical Substation

Switching centers, transformer locations, and other power-related facilities that serve as storage or transit points in the distribution system.

Emergency Communications Facilities

Buildings housing emergency communications transmission equipment and related offices, including 911 emergency centers, disaster coordination facilities and essential communication facilities for disaster recovery and response.

Marine Cargo Terminal

Establishments providing for temporary storage, loading and unloading of cargo shipped via water transportation. Examples include the National City and 10th Avenue Marine Terminals.

¹³ Based on building separation criteria from the National Fire Protection Association, NFPA 1, *Fire Code*, 2012 Edition, Chapter 63, Tables 63.3.6.2, 63.3.7.2.

¹⁴ Title 40, Code of Federal Regulations, Part 355, *Emergency Planning and Preparation*, Appendices A and B.

¹⁵ California Code of Regulations, Title 8, Subchapter 7 *General Industry Safety Orders*, Group 18 *Explosives and Pyrotechnics*, Article 114 *Storage of Explosives*.

¹⁶ Biosafety Level 2 facilities handle agents that pose moderate hazards to personnel and the environment. U.S. Department of Health and Human Services, Centers for Disease Control and Prevention, and National Institutes of Health, *Biosafety in Microbiological and Biomedical Laboratories*, December 2009. (Biosafety Level 1 does not involve hazardous materials.)

Marine Passenger Terminal

Establishments providing water transportation, including scenic and sightseeing, for passengers. Examples include the Cruise Ship Terminal/B Street Pier and the Embarcadero/North Harbor Drive.

Transit Center, Bus/Rail Station

- Transit Center/Rail Station: These include major transit centers, rail stations, Coaster stations, major trolley stations and seaport terminals. Parking areas associated with these uses are included. Transit centers within shopping centers are included within the retail-high intensity category.
- Bus Depot: A building for bus passengers or freight, including ticketing, passenger boarding and freight loading facilities.

Transportation, Communication, Utilities – General

Transportation, communication and utilities uses not specified in other categories.

Truck Terminal

Establishments that provide general freight trucking. They handle a wide variety of commodities, generally palletized and transported in a container or van trailer. Included are establishments operating as truckload (TL) or less than truckload (LTL) carriers.

Water, Wastewater Treatment Plant

- Water Treatment Plants: Establishments operating water treatment plants, filtration plants, pumping stations and similar facilities for drinking water or irrigation and industrial supply.
- Wastewater Treatment Plants: Establishments operating sewer systems or sewage treatment facilities. This category does not include septic pumping and other miscellaneous waste management services.

RECREATION, PARK, OPEN SPACE

Arena, Stadium

Indoor and outdoor facilities for spectator sports and entertainment performances. Structurally, the main distinction between a stadium and an arena is its size. Stadiums are larger than arenas and generally seat over 10,000 spectators whereas arenas generally seat over 5,000 spectators. The layout of seating and sight lines in stadiums follow a fixed sport (e.g., baseball or football), whereas arenas are designed around the flat, central space whose size is about the size of a basketball court. Arenas also host circuses, ice shows, indoor soccer, hockey games, horse shows and music concerts.

Golf Course

Public and private courses consisting of large landscaped areas for playing golf.

Golf Course Clubhouse

Clubhouses, including eating, drinking, retail sales, locker rooms and meeting areas associated with a golf course.

Marina

Marinas provide docking and storage facilities for pleasure craft owners. They may retail fuel and marine supplies, and may repair, maintain or rent pleasure boats in addition to operating facilities. Examples include Oceanside Harbor, Quivira Basin, Shelter Island, Harbor Island, Embarcadero and the Chula Vista marinas.

Park, Open Space, Recreation

Lands, whether publicly or privately owned, dedicated or used for outdoor recreation, habitat preservation, environmental mitigation or similar activities. Examples include:

- **Park:** Land devoted for the public's enjoyment and its recreational activities, ranging from passive to active uses.
- **Open Space:** This includes uses that may occur on land that have been identified for public recreational uses or to be left in a generally natural state. Open space areas include beaches, canyons, hillsides, etc. Open space also consists of wildlife and nature preserves, lands set aside for open space and parks with limited development and access. Examples are Torrey Pines State Reserve, Penasquitos Canyon Reserve, San Elijo Ecological Preserve and Nature Conservancy properties.
- **Outdoor Recreation:** Land set aside for public, outdoor recreational use and enjoyment. Examples are Robb Field, Morley Field, Diamond Street Recreation Center and Presidio Park. Smaller neighborhood parks with a high level of use are also included.

AGRICULTURE

Agriculture

Establishments in this class grow fruit, nuts, root and tuber crops or edible plants and seeds, including community gardens. This category also includes livestock breeding and feeding.

Aquaculture

Uses that grow plants and animals in a water medium, either indoors or outdoors.



APPENDIX B

Implementation Tools and Documents

This appendix provides information helpful to the implementation of this ALUCP.

- Applications for ALUCP Consistency Determinations – Submittal Requirements
- Avigation Easement
- Airport Overflight Agreement
- Implementation Guide
- Review Procedures
- [Solar Glare Hazard Analysis Tool](#)

Applications for ALUCP Consistency Determinations—Submittal Requirements

A proposed land use plan, regulation or project submitted to the Airport Land Use Commission (ALUC) for review, in accordance with **Section 1.7** in **Chapter 1** to determine consistency with this ALUCP, shall include the following information.

Land Use Plans and Regulations

The following information must be submitted for all consistency determination applications for the ALUC's review of land use plans and regulations such as general, specific, community or other land use plan adoptions or amendments; land use code adoptions or amendments or rezones.

- (a) Map(s) indicating County Assessor's parcel(s) affected by the plan and/or regulation (unless it is applicable to the local agency's entire jurisdiction)
- (b) Contact information for local agency project manager (name, agency/department name, address, phone, fax, email)
- (c) Text of the ordinance, code, or plan to be adopted, describing permitted and prohibited uses by land use designation or zone and any related development standards regarding structure height, residential density, floor area ratio; if the policy amends existing text, a complete version in strikeout/underline format
- (d) Date plan/regulation was deemed complete per the California Government Code by the local agency

Land Use Projects

The following information must be submitted for all consistency determination applications for the ALUC's review of land use projects.

- (a) Property location by street address (or intersection) and County Assessor's Parcel Number(s)
- (b) Contact information for local agency project manager (name, agency/department name, address, phone, fax, email)
- (c) Description of land use project to include:
 - Proposed use(s)
 - Building area(s) and height(s) above grade
 - Maximum ground elevation above mean sea level
 - Lot coverage
 - Area of parcel(s)
 - Floor area ratio
 - For residential uses – number of dwelling units
 - For nonresidential uses – number of people occupying proposed use
- (d) Either a grant deed or title report, in the name of the current property owner
- (e) If FAA notification is required for proposed structures – Part 77 determination
- (f) Site plan, floor plans, and dimensioned elevations
- (g) Date project was deemed complete per the California Government Code by the local agency

Avigation Easement

Recording requested by:)
)
)
)
)
 SAN DIEGO COUNTY REGIONAL)
 AIRPORT AUTHORITY)
)
)
 and when recorded mail to:)
)
)
)
 Office of Airport Authority Clerk)
 San Diego County)
 Regional Airport Authority)
 PO Box 82776)
 San Diego, CA 92138-2776)
) Space above this line for Recorder's use

ASSESSOR PARCEL # _____

GRANT OF AVIGATION EASEMENT

RECITALS:

1. _____
 (provide complete legal name of all owners of record of subject property)

 (state identity of property owner – e.g., single man/woman, husband and wife, a corporation)

“Grantor(s)”, is (are) the owner(s), as _____
 (designate how title to property is held – e.g., joint tenants, community property)

of the fee simple estate in and to that certain real property situated in the County of San Diego,
 State of California, commonly described as

 (provide street address and zip code of subject property)

and more particularly described as follows: (the “Subject Property”);

 (provide complete legal description and assessor parcel number of subject property)

2. It is the desire of Grantor(s), for itself, its heirs, administrators, executors, successors, assigns,
 tenants, guests, and other persons in or using the Subject Property with the implied or express consent of
 Grantor(s), to grant to the San Diego County Regional Airport Authority, a local governmental entity of

regional government organized under the laws of the State of California and possessing jurisdiction extending throughout the County of San Diego, (the "Authority"), an air and aviation easement, also known as a perpetual air, flight or noise easement, on, upon, over, across, above the Subject Property, and to all of the airspace (as hereinafter defined) above the Subject Property, whereby Grantor(s) relinquishes certain rights relative to the Subject Property, as described in this Grant of Aviation Easement ("Avigation Easement");

3. The purpose of this Avigation Easement, and its acceptance by the Authority, includes granting the Authority, its successors and assigns, and aviation easement permitting the unencumbered and unrestricted flight of aircraft to or from San Diego International Airport ("SDIA"), owned and operated by the Authority, without liability to the Authority, to the aircraft operator, or to any other person lawfully operating aircraft to or from SDIA in the navigable airspace of the United States (as defined at 45 U.S.C. §40102(a)(32), and as that section of the United States Code (and the referenced regulations) existed on the effective date of this Avigation Easement), and in accordance with relevant regulations of the United States of America and the State of California, pursuant to the authority granted to the Authority by the people and the State of California;

4. Pursuant to the Airport Land Use Compatibility Plan ("ALUCP") for SDIA, as a condition of, and prior to, approval of a permit for the development or improvement of the Subject Property, the execution of this Avigation Easement shall be required in favor of the Authority under which SDIA is the dominant tenement when the Subject Property meets any of the following:

- Is located within the 65 decibel (dB) Community Noise Equivalent Level (CNEL) noise contours or greater and has been designated by the ALUCP to require an aviation easement
- Is located on a site where the ground level penetrates a FAR Part 77 airspace surface
- Includes structures or vegetation exceeding obstruction standards of FAR Part 77

5. The determination of whether the Subject Property falls within the 65 dB CNEL contour or greater shall be based upon the 2030 CNEL contours for SDIA.

6. The Avigation Easement shall be recorded in the chain of title in the County Recorder's Office prior to issuance of a permit for development or improvement of the Subject Property;

7. This Avigation Easement is intended to benefit the Grantor(s), the Subject Property, the Authority, and all users of SDIA, and shall be binding on Grantor, its heirs, administrators, executors, successors, assigns, tenants, guests, and other persons in or using the Subject property with the implied or express consent of the Grantor(s)

NOW, THEREFORE, for valuable consideration, receipt of which is hereby acknowledged:

WARRANTIES AND COVENANTS

Grantor(s) warrants and covenants to the Authority that as of the date hereof:

1. Grantor(s) holds the entire fee simple interest in the Subject Property;
2. Grantor(s) shall not convey (his/her/their/its) interest in the subject Property, or execute, deliver, comply, or permit recordation of any interest in the Subject Property, or any lien or encumbrance against the Subject Property (or any interest therein), until the earlier of the following events: (i) this Avigation Easement has been properly executed by Grantor(s), accepted by the Airport Authority, and recorded by the San Diego County Recorder; or (ii) thirty (30) days have elapsed after Grantor(s) has delivered this Avigation Easement to the Authority, properly and fully executed and notarized.

3. If the person(s) executing this Avigation Easement is other than the Grantor(s), the person(s) executing this Avigation Easement, or his or her attorney, has represented to the Authority in documentation separate from this grant, that the person(s) is duly and lawfully authorized by Grantor(s) to execute this Avigation Easement on behalf of Grantor(s).

GRANT OF AVIGATION EASEMENT

4. In consideration and incorporation into this Avigation Easement of the Recitals, Warranties and Covenants set forth above, Grantor(s), individually and for its heirs, administrators, executors, tenants, guests, agents successors, assigns, and other persons in or using the Subject Property with the implied or express consent of Grantor(s), hereby grants, conveys and assigns to the Authority, its successors, and assigns, a perpetual non-exclusive avigation easement for the purposes of aircraft operations, aircraft sound and noise, aircraft avigation and flight, hazard and airspace in, to, over and through all airspace above the Subject Property, as well as the imposition in, on, over and upon the Subject Property of noise, vibration, fumes, fuel particles, dust, discomfort or other environmental effects incident to such and all resulting annoyance, inconvenience, or other interference with the use and enjoyment of the Subject Property and any consequent reduction in market value, all due to the operation of aircraft to and/or from SDIA, including landing, taking off from, taxiing, maintenance, or other aircraft related facility operations at or on SDIA. For purposes of this Avigation Easement, the term "aircraft" shall mean any contrivance now known or hereafter invented, used or designed for navigation or flight in the air.

5. This Avigation Easement is for the use of such airspace by any aircraft, present or future, in whatever form or type, during operations at, on, to, or from SDIA, including any future change to or increase in SDIA's boundaries and/or in the volume or pattern of aircraft traffic or aircraft noise, by all existing or future types of aircraft, up to and including the SDIA Year 2014 noise contours plus 1.5 dB CNEL, including the imposition on the surface of the Subject Property and on any and all structures on the Subject Property of such noise, vibration, fumes, fuel particles, dust, discomfort or other environmental effects incident to such aircraft operations and any and all resulting annoyance, nuisance, inconvenience, taking of or damage to the Subject Property, or any portion of the Subject Property, or other interference with the use and enjoyment of the Subject Property and any consequent reduction in market value. This Avigation Easement shall continue notwithstanding any future changes or increases in the type, volume, frequency, duration, or location of operations to, from or at SDIA.

6. It is expressly intended by the Grantor(s) and the Authority that this Avigation shall not supersede or impair any existing prescriptive, avigation, or other easements, rights or interest of the Authority or its predecessor in interest, in or applicable to the Subject Property, all of which easements, rights, interests, and any remedies related thereto are expressly reserved by the Authority.

7. In furtherance of this Avigation Easement, and rights herein granted, Grantor(s), and the heirs, agents, successors, and assigns of Grantor(s) hereby covenant at all times hereafter, that it/they will not take any action, cause or allow any electronic or other transmissions or emissions, or construct or grow any obstruction on the Subject Property which would conflict or interfere with or infringe on the Authority's rights herein granted.

8. Subject to the provisions set forth above in Paragraph 5, the rights, easements, benefits, restrictions, covenants and agreements granted herein, including this Avigation Easement, shall continue notwithstanding any increase or other change in the boundaries, volume of operations, noise, or pattern of air traffic at SDIA. This Avigation Easement may not be modified, amended, terminated, or abandoned except by execution and delivery of an instrument executed and acknowledged by the Authority, or its agents, successors, and assigns, and Grantor(s) agrees(s) that, in the absence of such an instrument, no conduct by the Authority, or its agents, successors and assigns, or increase, diminution, or change in use of this Avigation Easement, shall constitute an overburdening of this Avigation Easement or a termination or abandonment of this Avigation Easement.

9. This Avigation Easement also includes all things that may be alleged to be incident to or resulting from the use and enjoyment of this Avigation Easement, including, but not limited to, the Authority's continuing right to prevent, prohibit, clear, and keep clear from the airspace above the Subject Property any buildings, portions of buildings, structures or improvements of any kind, and of trees, vegetation, or other objects that may cause interference with aircraft navigation and/or operations at SDIA, including the right to remove or demolish those portions of such.

10. The parties to this Avigation Easement acknowledge and agree that the easement, and all the rights, easements, benefits, restrictions, covenants and agreements set forth herein shall run with the land of the Grantor(s) and the Authority, and any grantee, heir, agent, successor or assign of the Grantor(s) who acquires any estate or interest in or right to use the Subject Property shall be bound by this Avigation Easement for the benefit of SDIA and the Authority, and its agents, successors and assigns, including without limitation, the tenants and licensees of the Authority, and all users of SDIA. This Avigation Easement and all rights pertaining hereto is hereby vested in the Authority, its successors and assigns, forever and without limit in time, and shall be binding upon the successors and assigns of Grantor(s).

11. This Avigation Easement constitutes an enforceable restriction pursuant to the provisions of California law, including but not limited to Section 21652 of the California Public Utilities Code, and shall bind Grantor(s), and the heirs, agents, successors and assigns of Grantor(s), and each and all of them, and shall be appurtenant to, and for the benefit of the real property commonly known as SDIA, which is more particularly described in Exhibit "A", attached hereto.

12. Grantor(s), and the grantees, heirs, agents, successors, and assigns of Grantor(s) hereby fully waive and forever release, and covenant not to assert or bring any right or cause of action, which it or they might now have, or which it or they may have in the future, against the Authority, its agents, successors and assigns caused by or relating to the use of this Avigation Easement or the exercise or rights under this Avigation Easement.

13. In the event that any one or more covenant, condition, right or other provision contained in this Avigation Easement is held to be invalid, void, or illegal by any court of competent jurisdiction, the same shall be deemed severable from the remainder of this Avigation Easement and shall in no way affect, impair, or invalidate any other covenant, condition, right or other provision contained in this Avigation Easement.

Date: _____ 20 _____

GRANTOR(S):

(signature)

(signature)

(print name)

(Grantor Acknowledgement)

State of California
County of San Diego

On _____, 20_____, before me, _____, Notary

Public, personally appeared:

(print name)

who, proved to me on the basis of satisfactory evidence to be the person(s) whose name(s) is/are subscribed to the within instrument and acknowledged to me that he/she/they executed the same in his/her/their authorized capacity(ies), and that by his/her/their signature(s) on the instrument the person(s), or the entity upon behalf of which the person(s) acted, executed the instrument.

I certify under PENALTY OF PERJURY under the laws of the State of California that the foregoing paragraph is true and correct.

WITNESS my hand and official seal.

Signature _____

CERTIFICATE OF ACCEPTANCE

In accordance with Section 27281 of the California Government Code, this is to certify that the interest in real property conveyed by this Grant of Avigation Easement, dated

_____, 20____, from:

(print name)

to the SAN DIEGO COUNTY REGIONAL AIRPORT AUTHORITY, a local governmental entity of regional government, is hereby accepted by the undersigned officer on behalf of the Board of the San Diego County Regional Airport Authority pursuant to authority conferred by Resolution No. 03-011 of said Authority Board adopted March 6, 2003, and the Grantee consents to recordation hereof by its duly authorized officer.

DATED: _____

SAN DIEGO COUNTY REGIONAL
AIRPORT AUTHORITY

By _____
Thella F. Bowens, President/CEO

SAN DIEGO COUNTY REGIONAL AIRPORT AUTHORITY
SAN DIEGO INTERNATIONAL AIRPORT
LEGAL DESCRIPTION

That land described in Parcels "1", "2", and "3" as follows:

Parcel "1":

Those portions of those lands conveyed to the San Diego Unified Port District by that certain Act of Legislature of the State of California pursuant to Chapter 67, Statutes of 1962, First Extraordinary Session, as amended, and delineated on that certain Miscellaneous Map No. 564, filed in the Office of the San Diego County Recorder May 28, 1976 as File No. 76-164686 in the City of San Diego, County of San Diego, State of California, more particularly described as follows:

That land described in "Abstract of Lease San Diego Port District to San Diego County Regional Airport Authority of Property Located at 3225-3707 North Harbor Drive San Diego California," per Document filed in the Office of the San Diego County Recorder January 6, 2003 as File No. 2003-0011593 of Official Records;

TOGETHER WITH:

Parcel "2":

Those portions of those lands conveyed to the San Diego Unified Port District by that certain Act of Legislature of the State of California pursuant to Chapter 67, Statutes of 1962, First Extraordinary Session, as amended, and delineated on that certain Miscellaneous Map No. 564, filed in the Office of the San Diego County Recorder May 28, 1976 as File No. 76-164686 in the City of San Diego, County of San Diego, State of California, more particularly described as follows:

That land described in "Abstract of Lease San Diego Port District to San Diego County Regional Airport Authority of Property Located on the Westerly Side of Pacific Highway Between the Prolongation of Washington Street and the Prolongation of Quince Street San Diego, California," per Document filed in the Office of the San Diego County Recorder January 6, 2003 as File No. 2003-0011736 of Official Records;

TOGETHER WITH:

Parcel "3":

That portion of that 231.21 acre tract of land in Warranty Deed from San Diego Securities Company dated June 4, 1917 filed in the Office of the San Diego County Recorder June 9, 1917 in Book 740 at Page 61 of Deeds, and that portion of that 180.34 acre tract of land acquired by Deed from the City of San Diego dated December 1, 1916 filed in the Office of the San Diego County Recorder September 5, 1917 in Book 739 at page 307 of Deeds in the City of San Diego, County of San Diego, State of California, more particularly described as follows:

That land described in "Lease with United States of America Commander, Naval Facilities Engineering Command Document No. 6060," per Document filed in the Office of the San Diego County Recorder July 18, 2002 as File No. 2002-0605027 of Official Records.

Prepared By:
Nolte Associates, Inc.

Paul G. Robotta 4/9/03
Paul G. Robotta, L.S. 5334 Date

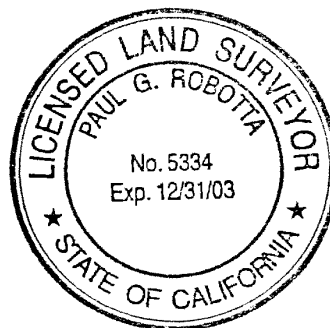

CERTIFICATION OF TRUST

Airport Overflight Agreement

Recorded for the benefit of
San Diego County Regional
Airport Authority as operator of
San Diego International Airport

Return to:

(property owner)

(SPACE ABOVE FOR RECORDER'S USE)

AIRPORT OVERFLIGHT AGREEMENT

This Airport Overflight Agreement concerns the real property situated in _____ *(insert City or unincorporated Community of _____)*, County of San Diego, State of California, described as *(insert or attach legal description)*:

_____.

This Airport Overflight Agreement provides disclosure of the condition of the above described property in recognition of, and in compliance with _____ *(insert local zoning ordinance section or other implementation document reference)*, and related state and local regulations and consistent with the San Diego County Airport Land Use Commission's policies for overflight agreements provided in the Airport Land Use Compatibility Plan for San Diego International Airport.

This property is located in the Overflight Area for the Airport Land Use Compatibility Plan for San Diego International Airport. For that reason, the property may be subject to some of the annoyances or inconveniences associated with proximity to an airport and aircraft operations (for example, noise, vibration, overflights or odors). Individual sensitivities to those annoyances can vary from person to person. You should consider what airport annoyances, if any, affect the Property before you complete your purchase and whether they are acceptable to you.

The undersigned owner(s) of the property subject to this agreement hereby agree, for themselves and their successors, to the conditions associated with this Airport Overflight Agreement. This Airport Overflight Agreement shall run with the Property and shall be binding upon all parties having or acquiring any right, title or interest in the Property.

OWNER(S)

Name

Date

Name

Date

(Attach California All Purpose Acknowledgement)

Implementation Guide

This guide is provided to help affected local agencies when modifying their general plans and other local regulations to be consistent with this ALUCP and to facilitate ALUC review of those local agency plans and regulations.

General Plan

A general plan, and any specific, community, or other land use plan may be more restrictive than this ALUCP. However, these plans may not be more permissive than this ALUCP. General plan amendments will be required if there are any conflicts with the ALUCP (unless those conflicts represent existing conditions).

Land Use Element — General plan land use designations may not exceed ALUCP safety compatibility standards. Designations reflecting existing conditions already in excess of ALUCP safety standards do not render a general plan inconsistent with this ALUCP. However, new development of vacant property, redevelopment or a change of use within an existing structure must comply with ALUCP safety standards. Additionally, prohibited land uses are not allowed within the safety zones.

Noise Element — Maximum noise exposure limits for land uses established in a general plan may not be more permissive than the limits established by this ALUCP. However, a general plan may establish more restrictive limits with respect to aviation-related noise than for noise from other sources, in consideration that aviation-related noise is often judged to be more objectionable than other types of noise. Prohibited land uses within the noise contours established by this ALUCP are not allowed.

Zoning Ordinance or Other Regulatory Documents

If a local agency chooses to implement this ALUCP through its zoning ordinance or other regulatory documents, the following items should be addressed. Modification of a general plan to achieve consistency with this ALUCP is typically not necessary if this option is selected. Modifications would typically be required to eliminate any conflicting language and to make reference to the separate regulatory document.

Intensity Limitations on Nonresidential Uses — While most zoning ordinances are not based on people per acre intensities for nonresidential land uses, such policies can be established by other performance-oriented criteria that correspond to this ALUCP. These include limits on building area, floor area ratios, habitable floors, or other design parameters equivalent to the usage intensity criteria.

Prohibition of Specified Uses — Prohibited land uses are not allowed within the safety zones or noise contours.

Height Limitations and Other Hazards to Flight — To protect airspace, limitations must be set on the height of new structures and other objects equivalent to the maximum heights

established by this ALUCP as derived from Part 77 of Federal Aviation Regulations and the Threshold Siting Surfaces. Restrictions must also be established on other land use characteristics that can cause hazards to flight such as visual or electronic interference with navigation and uses that attract birds.

Sound Attenuation Requirements — This ALUCP requires sound attenuation of structures for certain new uses within high noise-impact areas to reduce aircraft-related noise to an acceptable level. These criteria apply to new residences, schools, and other buildings housing noise-sensitive uses. Local regulations must include equivalent criteria.

Avigation Easements and Overflight Agreements — As a condition of approval for new development within certain noise contours or involving airspace penetrations, this ALUCP requires dedication of an avigation easement to the airport operator. New residential development requires recordation of an overflight agreement regarding airport-related impacts as a condition of approval. Local regulations must address these requirements for new development.

Nonconforming Uses and Reconstruction — Local agency regulations regarding nonconforming uses and reconstruction must be equivalent to or more restrictive than those in this ALUCP. Local agency definitions of these terms will differ from those in this ALUCP, therefore separate provisions must be made to address these policies.

Review Procedures

In addition to incorporation of ALUC compatibility criteria, local agency implementing documents must specify the manner in which land use plans, regulations and projects will be reviewed for consistency with the compatibility standards.

Actions Always Requiring ALUC Review — All local agency legislative actions require ALUC review regardless of whether or not the agency has an ALUCP implementation plan that has been approved by the ALUC and adopted by the local agency's governing body, or if the local agency has overruled this ALUCP. These legislative actions include the adoption of or amendments to a general plan or any specific, community, or other land use plans. Also included are amendments to a zoning ordinance (such as rezones) or building code which would impact matters regulated by this ALUCP.

Process for Compatibility Reviews by Local Agencies — Local agencies must establish project processing procedures that will be used to ensure that ALUCP compatibility policies and standards are addressed during project reviews, whether discretionary or ministerial. This can be accomplished by a standard review procedure checklist that includes reference to ALUCP compatibility standards and use of a GIS-based program to identify all parcels within the airport influence area.

Variances and Deviations — Local agency procedures for granting variances and deviations to a zoning ordinance must include provisions to ensure that they do not result in a conflict

with ALUCP compatibility standards. Any variance or deviation that involves issues of noise, safety, airspace protection, or overflight compatibility, as addressed in the ALUCP, must always be referred to the ALUC for review.

Condition Satisfaction and Enforcement — Policies must be established to ensure compliance with ALUCP compatibility standards during both the permitting process and the lifetime of the development. Enforcement procedures are especially necessary with regard to adhering to limitations on safety zone densities and intensities.

Solar Glare Hazard Analysis Tool

The increasing interest in renewable sources of energy has produced dramatic technological advances in the 21st Century. Solar technologies have been employed in a variety of settings in California and across the country. The FAA has taken an interest in these developments as they may interfere with the safe operation of aircraft in the immediate environs of airports. Under certain circumstances, glint and glare from mirrors in solar arrays and from photovoltaic cells can interfere with the vision of pilots and airport traffic controllers.

In coordination with the U.S. Department of Energy, the FAA has made available to the public a Solar Glare Hazard Analysis Tool for evaluating the potential for solar installations to cause problematic glint and glare along the approach paths to airport runways. The tool is available at this website: <https://share.sandia.gov/phlux>. Users must register to gain access to the tool, but registration is free of charge.

For more information about FAA policies related to the installation of solar facilities on and near airports, refer to the FAA Airports' website site at <http://www.faa.gov/airports/environmental/>.



APPENDIX C

References and Guidance

This appendix provides a list of references and guidance sources helpful to the implementation and administration of this ALUCP.

California Building Code, Title 24, Part 2, Chapter 12, Section 1207.11.3, *Airport Noise Sources*

California Business and Professions Code, Division 4, Part 2, Chapter 1, *Subdivided Lands*, Article 2, *Investigation, Regulation and Report*

California Civil Code, Division 2, Part 4, *Acquisition of Property*

California Code of Civil Procedure, Part 2, Title 10, Chapter 2, *Actions for Nuisance, Waste, and Willful Trespass, in Certain Cases, on Real Property*, §731a

California Code of Regulations, Title 8, Subchapter 7, *General Industry Safety Orders*, Group 18 *Explosives and Pyrotechnics*, Article 114, *Storage of Explosives*

California Code of Regulations, Title 21, Division 2.5, Chapter 6, *Noise Standards*, Section 5037(f)

California Department of Transportation, Division of Aeronautics, *California Airport Land Use Planning Handbook*, October 2011

California Government Code, Title 7, *Planning and Land Use*, Division 1, *Planning and Zoning*

California Public Utilities Code, Division 9, Part 1, Chapter 4, *Airports and Air Navigation Facilities*

City of San Diego, *General Plan, Economic Prosperity Element*, March 10, 2008

Federal Aviation Administration, Advisory Circular 70/7460-1K, *Obstruction Marking and Lighting*

Federal Aviation Administration, Advisory Circular 150/5200-33B, *Hazardous Wildlife Attractants on or Near Airports*

Federal Aviation Administration, Advisory Circular 150/5200-34, *Construction or Establishment of Landfills near Public Airports*

Federal Aviation Administration, Advisory Circular 150/5300-13A, *Airport Design*

Federal Aviation Administration, Advisory Circular 150/5300-33, *Hazardous Wildlife Attractants on or near Airports*

Federal Aviation Administration, Order JO 7400.2J, *Procedures for Handling Airspace Matters*, Paragraph 7-1-3

National Fire Protection Association, NFPA 1, *Fire Code*, 2012 Edition

Partnership for AiR Transportation Noise and Emissions Reduction (PARTNER), REPORT NO. PARTNER COE-2008-001, *Land Use Management and Airport Controls*, December 2007

Title 14, Code of Federal Regulations, Part 77, *Safe, Efficient Use, and Preservation of the Navigable Airspace*, Subpart B, *Notice Requirements*

Title 14, Code of Federal Regulations, Part 77, *Safe Efficient Use and Preservation of the Navigable Airspace*, Subpart C, *Standards for Determining Obstructions to Air Navigation or Navigational Aids or Facilities*

Title 14, Code of Federal Regulations, Part 77, *Safe Efficient Use and Preservation of the Navigable Airspace*, Subpart D, *Aeronautical Studies and Determinations*

Title 40, Code of Federal Regulations, Part 355, *Emergency Planning and Notification*, Appendices A and B

U.S. Department of Health and Human Services, *Biosafety in Microbiological and Biomedical Laboratories*, December 2009

U.S. Environmental Protection Agency, *Comprehensive Environmental Response, Compensation, and Liability Act (CERCLA)*



APPENDIX D

Definitions and Acronyms

This appendix provides a list of definitions and acronyms used in this ALUCP.

Definitions

14 CFR Part 77	The part of Title 14 of the Code of Federal Regulations that deals with the safe and efficient use of the navigable airspace. Part 77 sets forth requirements for notice to the FAA of certain proposed construction or alteration, establishes standards for identifying obstructions to navigable airspace, and provides for aeronautical studies of obstructions to determine their effect on the safe and efficient use of airspace.
Air Carriers	Commercial aircraft operators carrying passengers or cargo for hire and including certificated air carriers, air taxis (including commuters), supplemental air carriers and air travel clubs.
Aircraft Accident	An occurrence incident to flight in which, as a result of the operation of an aircraft, a person receives a fatal or serious injury or an aircraft receives substantial damage. Except as provided below, substantial damage means damage or structural failure that adversely affects the structural strength, performance, or flight characteristics of the aircraft and that would normally require major repair or replacement of the affected component. Engine failure, damage limited to an engine, bent fairings or cowling, dented skin, small puncture holes in the skin or fabric, ground damage to rotor or propeller blades, damage to landing gear, wheels, tires, flaps, engine accessories, brakes, or wingtips are not considered substantial damage.

Aircraft Operation	The airborne movement of aircraft at an airport or about an en route fix or at other point where counts can be made. At an airport, an operation is counted for each landing and each departure, such that a touch-and-go flight is counted as two operations.
Airport Elevation	The highest point of an airport's useable runways, measured in feet above mean sea level.
Airport Influence Area (AIA)	The area in which current and projected future airport-related noise, safety, airspace protection or overflight factors may significantly affect future land uses, necessitate restrictions on land use or warrant the disclosure of potential airport impacts to buyers of residential property.
Airport Layout Plan (ALP)	As used in this ALUCP, the term ALP refers to the official plan drawing approved by the FAA that depicts all existing and planned Airport facilities, runway and taxiway safety areas and the property boundary. It also includes data tables describing various components of the Airport.
Airport Master Plan	A comprehensive plan for development on Airport property. It includes airport activity forecasts, demand capacity analysis, an analysis of facility requirements, an evaluation of development alternatives and a final plan for development of airside and landside facilities. It also includes existing and future airport layout plan drawings and supporting plan drawings.
Airspace Protection Area	The area beneath the airspace protection surfaces for the Airport.
Airspace Protection Surfaces	Imaginary surfaces in the airspace surrounding airports, as defined for an individual airport in accordance with criteria set forth in 14 CFR Part 77, Subpart C, and FAA Order 8260.3B, U.S. Standard for Terminal Instrument Procedures (TERPS). These surfaces establish the maximum height that objects on the ground can reach without creating obstructions or hazards to the use of the airspace by aircraft approaching, departing or maneuvering in the vicinity of an airport.
Ambient Noise Level	The level of noise that is all encompassing within a given environment for which a single source cannot be determined. It is usually a composite of sounds from many and varied sources close to and far from the receiver.

Avigation Easement	An avigation easement is a particular form of easement that may convey, for example, the right of passage over the property and the right to cause associated impacts including noise.
Ceiling	Height above the earth's surface to the lowest layer of clouds or obscuring phenomena.
Community Noise Equivalent Level (CNEL)	CNEL is used to describe the total noise level in a community over a given 24-hour period. It is a 24-hour, time-weighted, cumulative noise metric. Acoustical scientists developed CNEL to aid in predicting the effects of noise on communities. CNEL describes the total noise in a 24-hour period, with the addition of 4.8 dB to evening noise events (between 7:00 p.m. and 10:00 p.m.) and 10 dB to nighttime noise (between 10:00 p.m. and 7:00 a.m.). The evening and nighttime weights are added because noise in those periods is more disturbing to people than daytime noise. In aircraft noise studies, CNEL is calculated for an average day during a given study year. CNEL levels are typically mapped as noise contours at intervals of 5 dB. Also, see "decibel."
Community Planning Area (CPA)	Community Planning Areas are neighborhoods in San Diego for which the City prepares community land use plans. Over 40 CPAs are in San Diego. The combination of all community plans constitutes the Land Use Element of the City's General Plan. The community plans must work as part of the General Plan and must not contain policies or recommendations that are contradictory to any element of the General Plan or to other community plans. Since the 1960s, when the first community plans in the City were undertaken, Community Planning Groups have participated with City officials in the development of those plans.
Decibel (dB)	A unit of measure describing the pressure level of a sound, equal to the logarithm of the ratio of the sound pressure to the pressure of a reference level equivalent to a sound barely audible to an unimpaired human ear. Because the human ear is more sensitive to sound at specific frequencies (or pitches), special weighting scales have been developed so that sound measurements can be adjusted to accurately describe sounds that people hear.

	<p>The A-weighting scale is most common. The A-weighted decibel is often indicated by "dBA." Where the context clearly indicates that the A-weighting scale is being used, as in this ALUCP, the "A" is usually dropped and the term "dB" is used. Also, see "Community Noise Equivalent Level (CNEL)."</p>
Deed Notices	<p>Deed notices are official statements recorded with a property deed. They note the presence of aircraft overflights above the property and describe the potential effects of the overflights.</p>
Displaced Threshold	<p>A landing threshold that is located at a point on the runway other than the designated beginning of the runway. Also, see "Threshold."</p>
Easement	<p>An easement is a legal document that gives one entity the right to use a part of the real estate owned by another entity, but only as specified in the easement document.</p>
Findings	<p>Legally relevant conclusions that describe a government agency's analysis of facts, regulations and policies, and that bridge the analytical gap between raw data and ultimate decision.</p>
Floor Area Ratio (FAR)	<p>For this ALUCP, this term means the gross building square footage (excluding parking garages) divided by the entire site's square footage (site area).</p>
General Aviation (GA)	<p>That portion of civil aviation that encompasses all facets of aviation except air carriers.</p>
Global Positioning System (GPS)	<p>A navigational system that utilizes a network of satellites to determine a positional fix on or above the earth. Developed and operated by the U.S. Department of Defense, GPS has been made available to the civilian sector for surface, marine and aerial navigational use. For aviation purposes, the current form of GPS guidance provides en route aerial navigation and selected types of nonprecision instrument approaches.</p>
Gross Acreage	<p>The total area of a development project, before lots are platted and public rights-of-way, parks and other public properties are dedicated. Also, see "Net Acreage."</p>
Handbook	<p>The California Airport Land Use Planning Handbook, published by the Caltrans Division of Aeronautics (October 2011).</p>

Hazard	An object exceeding an obstruction standard, or creating other adverse aeronautical effects, that the FAA has determined would have a "substantial adverse effect" to a "significant volume of aeronautical operations." ¹
Hazardous Materials	Substances that are considered severely harmful to human health and the environment. ² Examples include highly flammable, explosive, corrosive, and toxic materials.
Hill Effect	In this ALUCP, this term applies to a localized effect experienced on the hillside above Interstate 5, directly north of the east end of Runway 9-27. This hillside has a direct line-of-sight to the east end of Runway 27 and is exposed to noise from the breakaway thrust of departing aircraft without benefiting from ground absorption or shielding of noise by intervening structures. Extensive noise monitoring has found that the aircraft noise levels in this area are higher than predicted by the Integrated Noise Model. Noise monitoring has also confirmed that this effect ceases once the top of the plateau is crossed to the east.
Instrument Approach Procedure	A series of predetermined maneuvers by reference to flight instruments from the beginning of the initial approach to a point from which a landing can be completed and thereafter, if a landing is not completed, to a position at which holding or en route obstacle clearance criteria apply. Also, see "Nonprecision Approach Procedure" and "Precision Approach Procedure."
Instrument Flight Rules (IFR)	Rules governing the procedures for conducting instrument flight.
Instrument Landing System (ILS)	A precision instrument approach system that normally consists of the following electronic components and visual aids: (1) Localizer; (2) Glide Slope; (3) Outer Marker; (4) Middle Marker; (5) Approach Lights.
Integrated Noise Model (INM)	The INM is federally-sanctioned and was the industry-preferred modeling software for airport noise studies at the time this ALUCP was prepared.

¹ Federal Aviation Administration, Order JO 7400.2H, Procedures for Handling Airspace Matters, March 10, 2011 Sections 6-3-3 and 6-3-4.

² U.S. Environmental Protection Agency, *Comprehensive Environmental Response, Compensation, and Liability Act* (CERCLA), <http://www.epa.gov/osweroe1/content/hazsubs/cercsubs.htm> (accessed January 12, 2012).

Land Use Plans and Regulations

Any general plan, community plan, specific plan, precise plan, zoning ordinance, rezone, building regulation or any amendments to these policy and regulatory documents. Land use plans and regulations also include any school district, community college district or special district master plans or amendments to master plans.

Land Use Project

A land use project is a proposed development that requires a ministerial or discretionary permit or approval from a local agency or that is sponsored by a local agency and involves any of the following: construction of a new building; enlargement of the floor area of an existing building; the subdivision of land; a change of use within an existing structure (land uses are classified in Chapters 2 and 3 of this ALUCP); or an increase in the height of a structure or object. When a land use project includes a land use plan amendment or rezone, it is reviewed as a land use plan and regulation.

Landing Distance Available (LDA)

The runway length declared available and suitable for a landing aircraft.

Local Agency

In this ALUCP, the term "local agency" means the County of San Diego and any municipality with land use regulatory and permitting authority (including the San Diego Unified Port District). It also includes school districts, community college districts and special districts with the authority to build and operate public buildings and facilities.

Localizer (LOC)

The component of an ILS that provides course guidance to the runway.

Mean Sea Level (MSL)

An elevation datum using mean sea level as its reference elevation.

Navigational Aid (NAVAID)

Any visual or electronic device airborne or on the surface that provides point-to-point guidance information or position data to aircraft in flight.

Net Acreage

Net acreage refers to the building lot area available for development. Net acreage does not include land dedicated for public purposes, such as streets or parks. See "Gross Acreage."

Noise	Noise is unwanted sound. Sound is created by variations in air pressure and is measured in terms of pressure level. The decibel (dB) scale has been developed to describe sound pressure level. Also, see "decibel" and "Community Noise Equivalent Level (CNEL)."
Noise Contours	Continuous lines of equal noise level usually drawn around a noise source, such as an airport or highway. The lines are typically drawn in 5-decibel increments so that they resemble elevation contours in topographic maps.
Noise-Sensitive Land Uses	Land uses for which the associated primary activities, whether indoor or outdoor, are susceptible to disruption by loud noise events, such as sleeping rooms, activities where a quiet indoor environment is needed, such as classrooms, office areas, meeting rooms, performance halls or contemplative areas.
Nonconforming Use	As used in this ALUCP, a nonconforming use is an existing land use that is inconsistent with the noise or safety policies and standards for one of the following reasons: (1) the use is incompatible or (2) the use does not comply with the policies and standards that would make it acceptable as a conditional use
Nonprecision Approach Procedure	An instrument approach procedure providing only lateral guidance. Also, see "Instrument Approach Procedure."
Object Free Area (OFA)	A two-dimensional, rectangular-shaped area centered on the runway or taxiway centerline, with specific length and width which depend on the airplane design groups intended to operate on the airfield. According to FAA design standards, the OFA is to be clear of objects that could cause damage to an aircraft overrunning or veering off the runway. Only objects directly related to air navigation or aircraft maneuvering purposes are allowed within these areas.
Obstacle	An object that would penetrate an obstacle clearance surface or exceed other specific clearance requirements for a specific flight procedure, as defined by FAA instrument flight procedure design criteria. An obstacle is known as a "controlling obstacle" when a flight procedure is designed around that obstacle as the limiting factor.

Obstacle Free Zone (OFZ)	A three-dimensional, rectangular-shaped zone centered on the runway or taxiway centerline, with specific length, width and elevation based on the type of runway/taxiway. The OFZ clearing standards preclude object penetrations unless they are frangible, visual NAVAIDS.
Obstruction	An object that, upon evaluation, is determined by the FAA to require proper marking, lighting and identification in aeronautical publications so that it may be easily recognized by pilots of aircraft navigating through the airspace. FAA obstruction standards are defined in Title 14, Code of Federal Regulations (CFR) Part 77 (Part 77), Subpart C.
Occupancy Factor	An estimate of the amount of floor area attributable to an occupant of a nonresidential land use. It is used to estimate the total number of people occupying a nonresidential use during periods of typical activity. It does not indicate maximum structural capacity, maximum peak occupancy, or maximum occupancy allowed under any health or safety codes.
Overflight	Any distinctly visible or audible passage of an aircraft over an area.
Overlay Zone	A special purpose zoning district. The regulations within an overlay zone supplement the requirements of the underlying standard zoning districts (typically residential, commercial, or industrial). Overlay zones are used to achieve a special purpose, such as flood hazard protection or the preservation of a historic district, without directly changing the underlying land use in the affected area.
Precision Approach Procedure	An instrument approach procedure providing both lateral and vertical guidance. Also, see "Instrument Approach Procedure."
Project Sponsor	In this ALUCP, the term "project sponsor" refers to any person or entity having a legal interest in a property, including a local agency, landowner, nonresidential tenant who submits an application to a local agency for review of a proposed project on such property.
Real Estate Disclosure	This term refers to state law that requires sellers of residential property within an airport influence area (AIA) to notify buyers of potentially adverse effects from airport activity.

Runway Protection Zone (RPZ)	Two-dimensional, trapezoid-shaped areas defined off the ends of runways. The FAA advises airports to acquire RPZs and, if possible, clear all objects from the RPZs. If that is not practicable, land use controls should be adopted to prohibit housing, places of public assembly and fuel facilities.
Runway Safety Area (RSA)	A two-dimensional, rectangular-shaped area centered on the runway centerline, with specific length and width which depend on the airplane design groups and approach categories of aircraft intended to operate on the airfield. FAA design standards (Paragraph 307 of Advisory Circular 150/5300-13A "Airport Design") require RSAs to be cleared and graded with no potentially hazardous ruts, humps, depressions, or other surface variations. No objects higher than three inches above grade are permitted in the RSAs, unless they are deemed acceptable because of their function and constructed on frangible mounted structures.
Safety Zone	For the purpose of airport land use planning, an area near an airport in which land use restrictions are established to protect the safety of the public from potential aircraft accidents.
Standard Instrument Departure (SID)	A published procedure which describes specific maneuvers that aircraft departing an airport under IFR are to follow.
Takeoff Distance Available (TODA)	The TORA plus the length of any remaining runway or clearway beyond the far end of the TORA.
Takeoff Run Available (TORA)	The runway length declared available and suitable for the ground run of an airplane taking off.
TERPS (U.S. Standard for Terminal Instrument Procedures)	The U.S. Standard for Terminal Instrument Procedures (FAA Order 8260.3B) includes criteria for the protection of airspace needed for the safe execution of instrument approach and departure procedures. TERPS airspace surfaces are designed to provide minimum required obstacle clearance for aircraft operating in the airspace. Unlike Part 77 obstruction surfaces, which can be penetrated without necessarily creating a hazard to air navigation, any object of growth or construction penetrating a TERPS surface would become a hazard and an obstacle to flight.
Threshold	The beginning of that portion of the runway usable for landing. Also, see "Displaced Threshold."

Threshold Siting Surface (TSS)	The TSS is a three-dimensional surface sloping down to the ground along the approach to a runway. It is used to define the runway landing threshold. The threshold is located such that no existing obstacles penetrate the TSS. At existing airports, any objects that are allowed to penetrate the existing TSSs would cause the runway thresholds to be displaced, reducing available landing distances.
Touch-and-Go	An operation by an aircraft that lands and departs on a runway without stopping or exiting the runway.
Traffic Pattern	The traffic flow that is prescribed for aircraft landing at, taxiing on or taking off from an airport. The components of a typical traffic pattern are upwind leg, crosswind leg, downwind leg, base leg and final approach.
Visual Flight Rules (VFR)	Rules that govern the procedures for conducting flight under visual conditions.
Zoning	A police power measure, usually enacted by units of local government, in which the community is divided into districts or zones within which permitted and special uses are established, as are regulations governing lot size, building bulk, placement and other development standards. Requirements vary from district to district, but they must be uniform within districts. A zoning ordinance includes a map and the text of the regulations.

Acronyms

AC	Advisory Circular
AGL	Above Ground Level
AIA	Airport Influence Area
ALP	Airport Layout Plan
ALUC	Airport Land Use Commission
ALUCP	Airport Land Use Compatibility Plan
ANOMS	Airport Noise and Operations Monitoring System
ASDA	Accelerate-Stop Distance Available
CAGR	Compound Annual Growth Rate
Caltrans	California Department of Transportation
CBC	California Building Code
CEQA	California Environmental Quality Act
CFR	Code of Federal Regulations
CNEL	Community Noise Equivalent Level
CPA	Community Plan Area
dB	Decibel
dBA	Decibel, A-weighted
DNH	Determination of No Hazard
DOH	Determination of Hazard
FAA	Federal Aviation Administration
FAR	Floor Area Ratio
GA	General Aviation
GPS	Global Positioning System
IFR	Instrument Flight Rules
ILS	Instrument Landing System
INM	Integrated Noise Model
LDA	Landing Distance Available
LOC	Localizer

MSL	Mean Sea Level
NAVAID	Navigational Aid
NPH	Notice of Presumed Hazard
OFA	Object Free Area
OFZ	Obstacle Free Zone
RNAV	Area Navigation
ROC	Required Obstacle Clearance
RON	Remain-overnight
RPZ	Runway Protection Zone
RSA	Runway Safety Area
SANDAG	San Diego Association of Governments
SanGIS	San Diego Geographic Information Source
SCR	Substantial Conformance Review
SDCRAA	San Diego County Regional Airport Authority
SDIA	San Diego International Airport
SID	Standard Instrument Departure
TERPS	U.S. Standard for Terminal Instrument Procedures
TODA	Take Off Distance Available
TORA	Takeoff Run Available
TSS	Threshold Siting Surface
VFR	Visual Flight Rules
VOR	Very High Frequency Omni-Directional Range



APPENDIX E

Technical Analysis

E1: San Diego International Airport

San Diego International Airport (SDIA or the Airport) is the primary air carrier airport in the San Diego region. The Airport is situated on 661 acres (some of which are State tidelands) and is surrounded by varying existing urban land uses. SDIA is operated by the San Diego County Regional Airport Authority (SDCRAA or the Airport Authority).

E1.1 Airport Layout Plan

The current Airport Layout Plan (ALP), conditionally approved by the Federal Aviation Administration (FAA) in October 2012, is presented in **Exhibit E1-1**. The ALP depicts all existing and planned Airport facilities, runway and taxiway safety areas, and the property boundary. It also includes data tables describing various components of the Airport.

Runway 9-27 is 9,401 feet in length and 200 feet in width. Displaced thresholds are required on each end of Runway 9-27, as depicted in **Exhibit E1-2**, to ensure obstacle clearance by aircraft on approach to landing. This is needed because of the rising terrain to the east and to the west of the Airport. The Runway 9 threshold is displaced by 700 feet and Runway 27 threshold is displaced by 1,810 feet.

After the release of the July 2013 Draft ALUCP, on November 7, 2013, the FAA issued a Finding of No Significant Impact (FONSI) for the Runway 9 Displaced Threshold Environmental Assessment related to the relocation of the Runway 9 displaced threshold 300 feet to the east. The ultimate displaced threshold is depicted on Exhibit E1-1, the FAA approved ALP.

E1.2 Airport Operations

This section discusses instrument flight procedures, runway use, existing operations, and aircraft activity forecasts for SDIA. The activity forecast includes projections for enplaned passengers as well as aircraft activity. The use of the runway system and the airspace in the immediate Airport vicinity is a key consideration in airport land use compatibility planning. Air traffic control procedures directly influence the patterns of airport noise exposure, airspace protection areas, aircraft overflights, and the location and configuration of safety zones. The instrument procedures at SDIA are directly relevant to the airspace protection factor of the ALUCP as airspace surfaces are defined according to FAA criteria to meet obstacle clearance requirements.

E1.2.1 Instrument Approach Procedures

Instrument approaches provide electronic and visual guidance to the runway. They also provide guidance for missed approaches when pilots are unable to see the runway at the minimum decision altitude. The following published instrument approach procedures are available at SDIA.

Runway 9:

- Instrument Landing System (ILS)
- Area Navigation/RNAV (GPS)

Runway 27:

- Localizer (LOC)
- Area Navigation/RNAV (GPS)

Exhibits E1-3 and **E1-4** depict the instrument approach procedures, including the missed approaches, for Runway 9-27.

E1.2.2 Departure Procedures

The FAA publishes Standard Instrument Departure procedures (SIDs), which describe specific maneuvers that departing aircraft follow. SIDs simplify pilot-controller communication by eliminating the need for controllers to relate a detailed series of instructions verbally to pilots.

Currently, there are four SIDs for SDIA, depicted on **Exhibits E1.3** (for Runway 9) and **E1.4** (for Runway 27):

- BORDER FIVE DEPARTURE – for departures to the east and northeast from Runways 9 and 27
- LNSAY TWO DEPARTURE – for northbound departures from Runways 9 and 27
- PEBLE THREE DEPARTURE – for northbound departures from Runway 27
- POGGI TWO (RNAV) DEPARTURE – for east and northeast bound departures from Runway 27

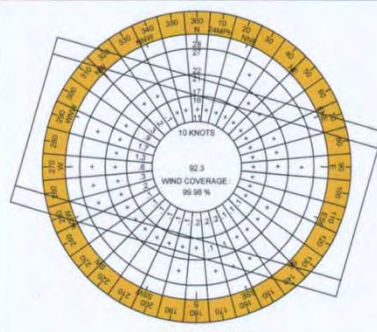

WIND ROSE
ALL WEATHER

CROSSWIND COMPONENT	RUNWAY HEADING
16 KNOTS	99.88%
20 KNOTS	99.98%

Source: National Climatic Data Center NOAA
National Weather Service
San Diego International Airport
San Diego, California - October 6, 2006

Period: 1996-2008

% of VFR Weather = 93%
% of IFR Weather = 6%



VICINITY MAP

LIST OF ABBREVIATIONS	
Abbreviation	Description
APL	Aircraft Parking Limit Line
ASOS	Automated Surface Observation System
BL	Building Restriction Line
CL	Centerline
DME	Distance Measuring Equipment
EMAS	Engineered Material Arresting System
GS	Glide Slope
GPS	Global Positioning System
IS	Instrument Landing System
LOC	Localizer
MALS	Medium Intensity Approach Lighting System
MALS	Medium Intensity Approach Lighting System with Runway Alignment Indicator Lights
MM	Middle Marker
NDB	Non-Directional Marker
NP	Non-Precision Instrument
OFA	Object Free Area
OFZ	Obstacle Free Zone
OM	Outer Marker
PACS	Primary Airport Control Station
PAPI	Precision Approach Path Indicator
PI	Precision Instrument
REL	Runway End Identifying Light
RPZ	Runway Protection Zone
RSA	Runway Safety Area
RVR	Runway Visual Range
SACS	Secondary Airport Control Station
TDZ	Touchdown Zone
TWR	TeleTYPE Ryan
TW	Taxiway
TWR	To be Removed
TDZL	Touch Down Zone Lights
S-100	Single Wheel Main Gear 100,000 Pounds Gross Aircraft Weight
D-150	Dual Wheel Main Gear 150,000 Pounds Gross Aircraft Weight
D-250	Dual Tandem Wheel Main Gear 250,000 Pounds Gross Aircraft Weight
DDT-720	Double Dual Tandem Wheel Main Gear 720,000 Pounds Gross Aircraft Weight

LEGEND	
BOUNDARY FENCE CHAIN LINK WOODEN	
PROPERTY LINE	
STORM INLET	
WATER HYDRANT (UG = UNDERGROUND)	
RUNWAY LIGHT	
ELEVATED RUNWAY GUARD LIGHT	
RUNWAY THRESHOLD LIGHT	
THRESHOLD BAR	
TERMINAL BUILDING	
FIELD STRUCTURE	
APRON AREA	
PAVED RUNWAY OVAL	
CALIFORNIA LEAST TERN NESTING PROTECTION AREA	
MALS AND MALS	
REL	
RUNWAY DISTANCE REMAINING SIGN	
OBJECT FREE AREA	
OBSTACLE FREE ZONE	
RUNWAY SAFETY AREA	
BUILDING RESTRICTION LINE	
CONTOUR ELEVATION	
WINDSOCK	
LIGHTED WINDSOCK	
AIRPORT REFERENCE POINT	
AIRPORT SURFACE DETECTION SYSTEM (ASDE-X)	
AIRPORT SURFACE DETECTION EQUIPMENT (ASDE-X)	
FUTURE DEVELOPMENT	
SURVEY MONUMENTS	
SDUPD-060	

AIRPORT FACILITIES INDEX	
Building Number	Building Elevation
Terminal One	2
Terminal Two (Pedestrian Bridges to be Demolished)	2
Commuter Terminal	3
Air Cargo Building	4
Air Cargo Building	5
Air Cargo Building	6
Fuel Dispensing Facility Administration Building	7
Fuel Dispensing Facility	8
Fixed Base Operator (To be Demolished)	9
Fixed Base Operator (To be Demolished)	10
Airline Support	11
Airline Support	12
S.D.C.R.A.A. General Services	13
S.D.C.R.A.A. Shipping and Receiving	14
S.D.C.R.A.A. Maintenance Shops	15
HVAC Plant	16
Parking Operations Building	17
U.S.O.	18
Airport Traffic Control Building and Tower	19
ARFF Station	20
San Diego County Regional Airport Authority	21
Electric Vault & Emergency Generator	22
Airport Rotating Beacon	23
Fuel Storage Tanks	24
FAA Communications	25
Airport Facilities Building	26
Electrical Utility Area	27
Waste Disposal Building	28

AIRPORT DATA	
AIRPORT CATEGORY	PRIMARY LARGE HUB
AIRPLANE DESIGN GROUP	GROUP V
AIRPORT REFERENCE POINT	D
AIRPORT REFERENCE POINT (ARP) RUNWAY CATEGORY	D
AIRPORT REFERENCE POINT (ARP) COORDINATES	R 80 + 08.20 S 00.00
MEAN MAXIMUM TEMPERATURE OF HOTTEST MONTH (AUGUST)	78° F
AIRPORT AND TERMINAL NAVIGATIONAL AIDS	ILS, ROTATING BEACON
GPS APPROACH	YES
MISC. FACILITIES:	
TAXIWAY LIGHTING, CENTERLINE MARKING, GUIDANCE SIGN SYSTEM.	
REMARK:	ALL TAXIWAYS SERVING RUNWAY 9/27 ARE LIGHTED EXCEPT WHERE OTHERWISE NOTED.

PROPOSED Airport Facilities Index	
Designation	
WEST SIDE	
Terminal 2 West Expansion	A
Aircraft Parking Apron and RON Apron	B
Apron and Aircraft Taxiway	C
Second Level Road/Curb and Vehicle Circulation	D
Parking Structure and Vehicle Circulation	E
1000' Displaced Threshold	F
Utility Plant Expansion	G
NORTH SIDE	
Central Receiving and Distribution Center (CRDC)	H
Cargo Facility	J
General Aviation Facilities - (GA)	K
Consolidated Rental Car Facility (CONRAC)	L
SAN Park Pacific Highway	M
North Taxiway 'E'	N
Vehicle Service Road Relocation (North of 9-27)	P

RUNWAY DATA		
	RUNWAY 9	RUNWAY 27
EFFECTIVE RUNWAY GRADIENT	0.05%	0.02%
PERCENT CROSSWIND COVERAGE-15 MPH	98.2%	96.7%
INSTRUMENT RUNWAY	ILS - CAT 1	LOCALIZER
RUNWAY LIGHTING*	HRLL, CL & TDZ	HRLL, CL & TDZ
PRECISION INSTRUMENT RUNWAY	LOC, OM, MALS	NON-PRECISION INSTRUMENT RUNWAY
NAVIGATION AIDS	MALS, DME, GPS	MALS, TR, DME
RUNWAY MAX ELEVATION (ABOVE NAVD 88)	16.87'	16.87'
LENGTH OF EXISTING RUNWAY	8,425'	8,425'
WIDTH OF EXISTING RUNWAY	200'	200'
RUNWAY SURFACE MATERIAL	Asphalt	Asphalt
PAVEMENT CLASSIFICATION NUMBER (PCN)	78 / F / B / W / T	78 / F / B / W / T
VISUAL AIDS, EXISTING AND PLANNED	MALS, TDZL	MALS, TDZL, PAPI
RSA DIMENSIONS	500' x 1,000'	500' x 1,000'
FAI PART 77	PI	PI

APPROACH SURFACES:
RWY 9: 34:1 FOR 10,000' FLARING UNIFORMLY FROM 1,000' WIDE STARTING AT 200' WEST OF DISPLACED THRESHOLD TO 4,000' WIDE AT END.
RWY 27: 30:1 FOR 10,000' FLARING UNIFORMLY FROM 1,000' WIDE STARTING AT 200' EAST OF DISPLACED THRESHOLD TO 3,000' WIDE AT END.

NOTES:
1. LATITUDE/LONGITUDE IDENTIFICATIONS ARE IN NAD 83.
2. RUNWAY CENTERLINE LIGHTS AT 50 FT. INTERVAL FROM 5' FROM THE R/W TO 10' FROM THE R/W.
3. TOUCHDOWN ZONE LIGHTS AT 100 FT. INTERVAL FROM 2' FROM THE R/W TO 5' FROM THE R/W.
4. NEAREST SECTION CORNERS ARE LOCATED OFF DRAWING.
5. THE ELEVATIONS SHOWN ON THIS DRAWING ARE BASED ON NORTH AMERICAN VERTICAL DATUM - 1988.
6. BECAUSE OF EXISTING PHYSICAL AND MAN-MADE CONSTRAINTS, EXTENSION OF THE RSA, OFZ AND OFPA TO THE EAST OF THE RUNWAY END IS IMPRACTICAL, AND IS THEREFORE NON-STANDARD.
7. RUNWAY LENGTH DETERMINED BY NATIONAL GEODETIC SURVEY ON 10/6/04.
8. ALL TAXIWAYS ARE 75' WIDE UNLESS NOTED OTHERWISE.
9. NO ON AIRPORT THRESHOLD STRIP PENETRATIONS.

FOR ADDITIONAL RUNWAY AND TAXIWAY DATA TABLE - SEE SHEET 2				
DECLARED DISTANCE				
RUNWAY 9 DISPLACED THRESHOLD 700' (EXISTING)	TORA	TODA	ASDA	LDA
RUNWAY 9	9,401'	9,401'	8,280'	7,591'
RUNWAY 27	9,401'	9,401'	9,401'	7,591'
FUTURE DECLARED DISTANCE 1000'				
RUNWAY 9 DISPLACED THRESHOLD 1000' (FUTURE)	TORA	TODA	ASDA	LDA
RUNWAY 9	9,401'	9,401'	8,280'	7,280'
RUNWAY 27	9,401'	9,401'	9,401'	7,591'

DEVIATIONS FROM FAA DESIGN STANDARDS			
DESIGN STANDARD	REQUIRED	EXISTING	ACTION
A RUNWAY - TAXIWAY SEPARATION	400'	362'	TO REMAIN - RELOCATE TO STANDARD AFTER TDY IS TOTALLY VACATED.
B TAXIWAY CENTERLINE TO FIXED OR MOVABLE OBJECT SEPARATION (FENCE)	190'	140'	TO REMAIN - RELOCATE TO STANDARD AFTER TDY IS TOTALLY VACATED.

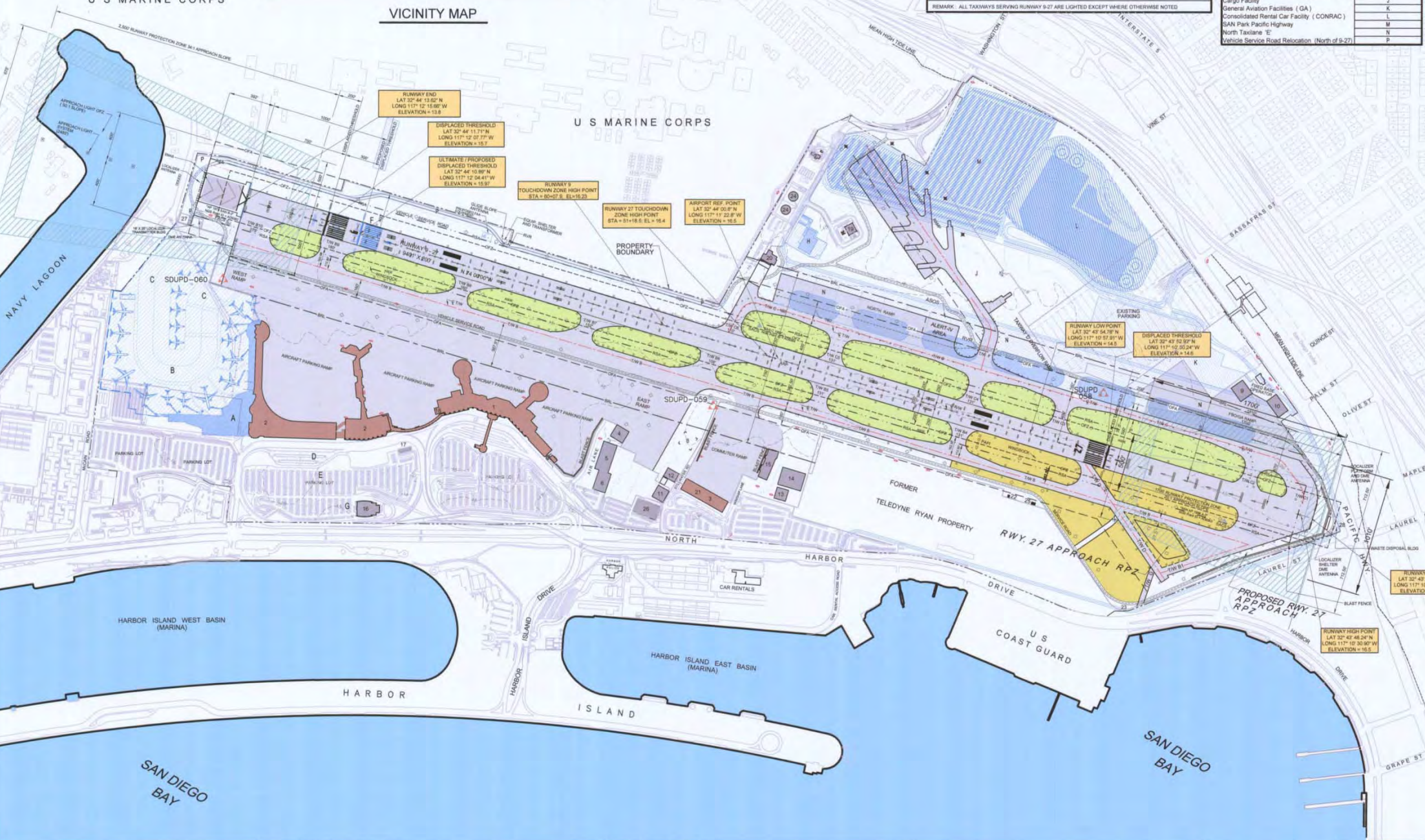
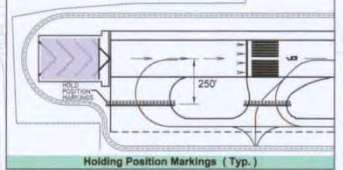

FAA APPROVAL BLOCK
Approved conditionally OCT 2 2 2012
Subject to comments contained in our letter dated: OCT 2 2 2012
FEDERAL AVIATION ADMINISTRATION
Western-Pacific Region
By: *[Signature]*
Manager - LAX/ADG

THE CONTENTS OF THIS PLAN DO NOT NECESSARILY REFLECT THE OFFICIAL VIEWS OR POLICY OF THE F.A.A. ACCEPTANCE OF THIS DOCUMENT BY THE F.A.A. DOES NOT IN ANY WAY CONSTITUTE A COMMITMENT ON THE PART OF THE UNITED STATES TO PARTICIPATE IN ANY DEVELOPMENT DEPICTED HEREIN NOR DOES IT INDICATE THAT THE PROPOSED DEVELOPMENT IS ENVIRONMENTALLY ACCEPTABLE IN ACCORDANCE WITH APPROPRIATE PUBLIC LAWS.

F.A.A. APPROVED A.L.P.	INCLUDES NORTH SIDE DEVELOPMENT ADDITIONS	10/5/12
F.A.A. CONDITIONALLY APPROVED A.L.P.	INCLUDES THE INSTITUTION OF "DECLARED DISTANCES"	7/10/09
F.A.A. REVALIDATED A.L.P.	TAXIWAY 'C' DEVELOPMENT GRANT - FISCAL YEAR 2008	9/04/08
F.A.A. REVALIDATED A.L.P.	REVALIDATION DUE TO CHANGES IN THE CURRENT INSTITUTION OF THE REGIONAL AIRPORT AUTHORITY WITH MINOR DRAWING MODIFICATIONS	8/05/03
F.A.A. APPROVED A.L.P.	MASTER PLAN UPDATE PREFERRED ALTERNATIVE MODIFICATIONS	11/29/01

SAN DIEGO INTERNATIONAL AIRPORT
SAN DIEGO COUNTY REGIONAL AIRPORT AUTHORITY

SAN DIEGO INTERNATIONAL AIRPORT
AIRPORT LAYOUT PLAN
SAN DIEGO, CALIFORNIA

724

Exhibit E1-1
Airport Layout Plan
FEBRUARY 2014



LEGEND

- Major Roads
- Highways
- - - Municipal Boundaries
- ▭ Airport Property Boundary
- ▭ Displaced Threshold
- - - Runway Protection Zones

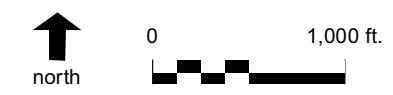

Sources: San Diego Geographic Information Source (SanGIS), 2008 (municipal boundaries); Ricondo & Associates, Inc., January 2012, based on San Diego County Regional Airport Authority, Airport Layout Plan, July 10, 2009 (runway protection zones and displaced thresholds).

Prepared by: Ricondo & Associates, Inc., December 2013.

Exhibit E1-2
Runway Protection Zones
and Displaced Thresholds

Portions of this DERIVED PRODUCT contain geographic information copyrighted by SanGIS. All Rights Reserved.

Source: Esri, DigitalGlobe, GeoEye, i-cubed, USDA, USGS, AEX, Getmapping, Aerogrid, IGN, IGP, swisstopo, and the GIS User Community

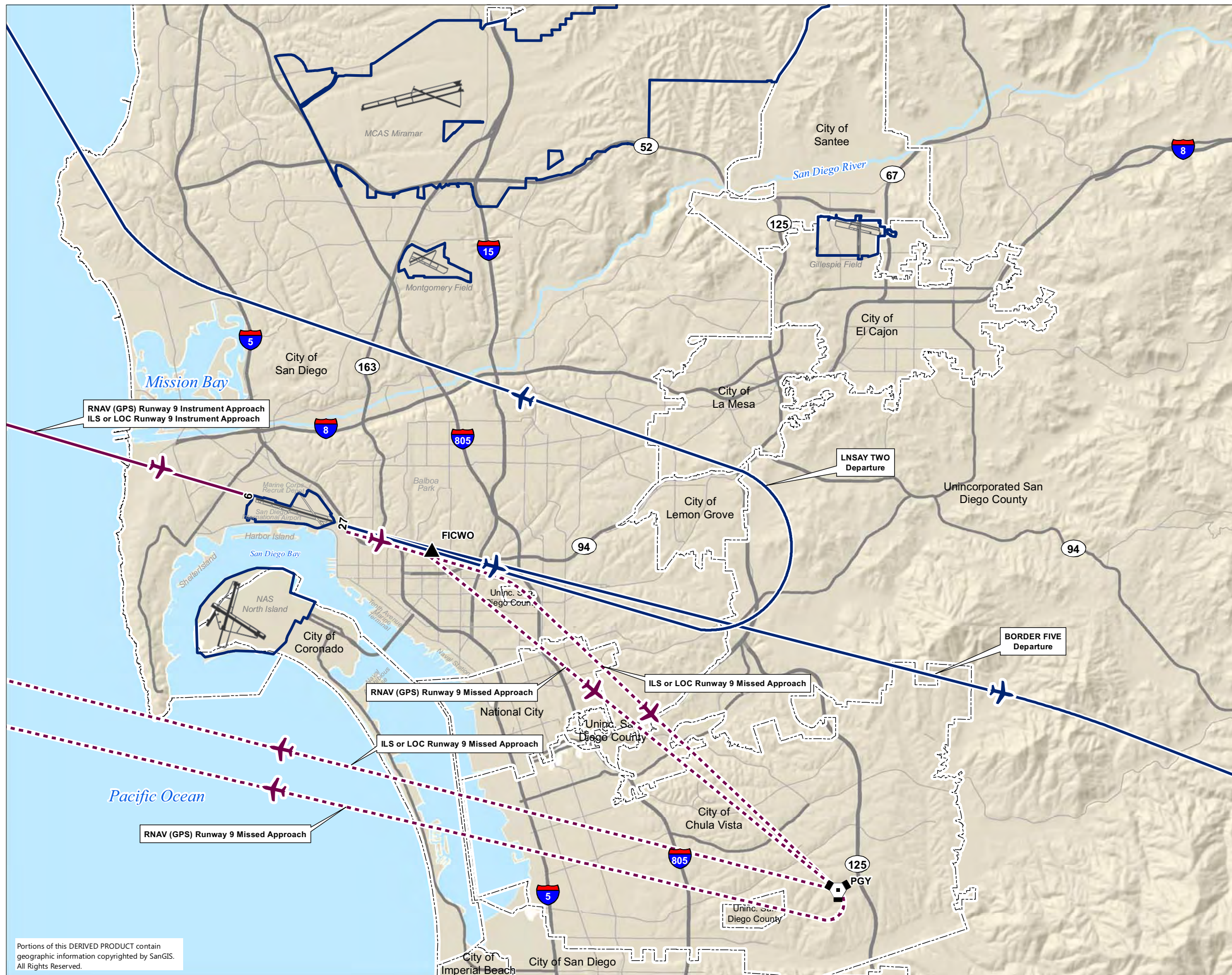

LEGEND

- Major Roads
- Highways
- - - Municipal Boundaries
- ▭ Airport Property Boundary
- ✈ Instrument approach procedure - Runway 9¹
- ✈ Missed approach procedure - Runway 9¹
- ✈ Standard instrument departure procedure - Runway 9¹
- ▲ Airspace fix²
- ⬢ VORTAC³



- Notes:
1. The routes shown depict approximate routes as published on National Aeronautical Charting Office charts. Actual aircraft flight tracks over the ground will vary based on air traffic control procedures, aircraft types, and weather conditions.
 2. Airspace fixes may include intersections of VOR radials and/or RNAV/GPS waypoints.
 3. VORTAC = Combined very high frequency omni-directional radio range (VOR) and Tactical Air Navigation System (TACAN) facility; RNAV = Area navigation; GPS = Global Positioning System.

Sources: Federal Aviation Administration, National Aeronautical Charting Office (published departure and arrival routes and procedures effective January 14, 2010; airspace fix and VORTAC); San Diego Geographic Information Source (SanGIS), 2008 (municipal boundaries, roads and highways)

Prepared by: Ricondo & Associates, Inc., March 2012.

Exhibit E1-3
Instrument Procedures
Runway 9

Portions of this DERIVED PRODUCT contain geographic information copyrighted by SanGIS. All Rights Reserved.

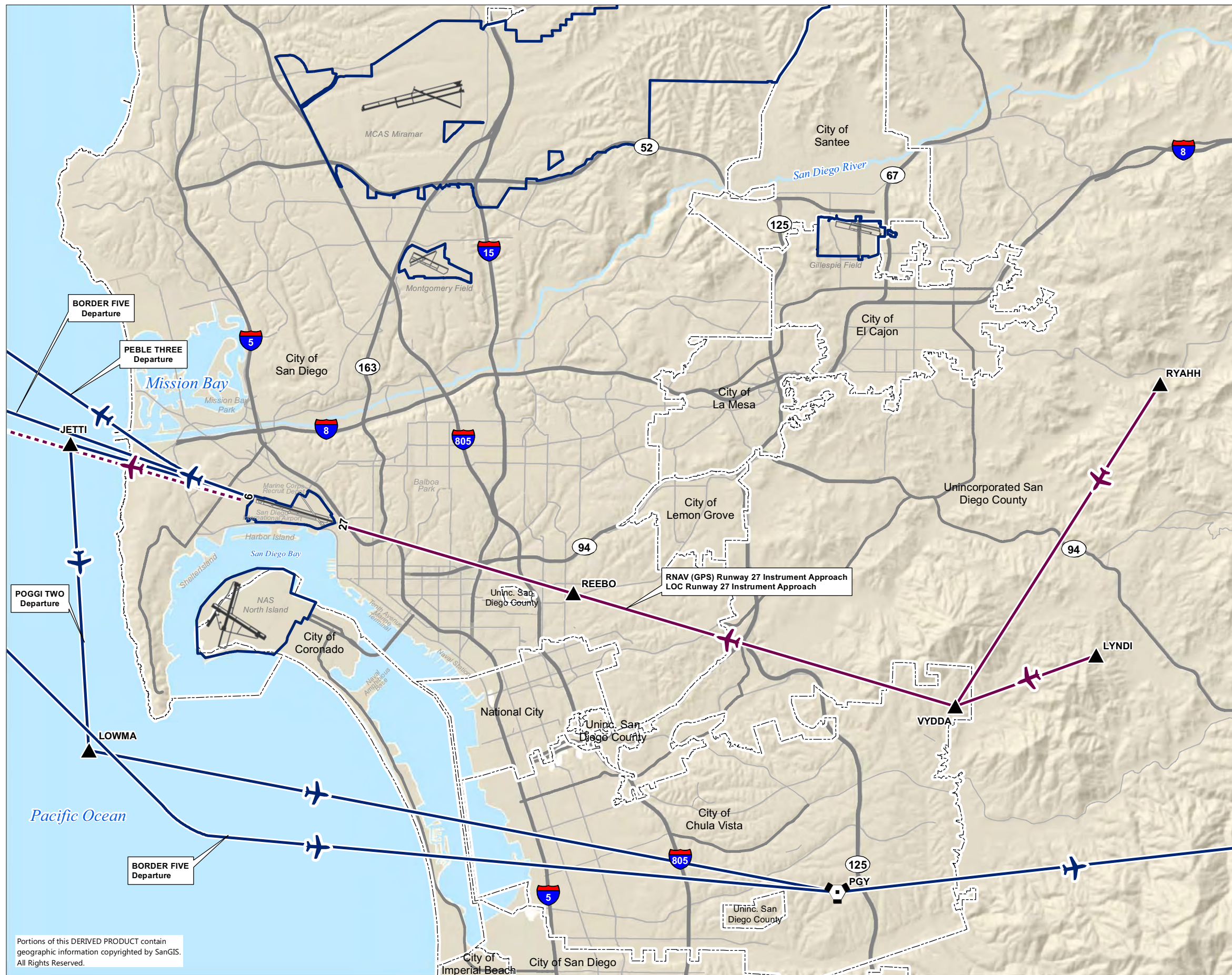

LEGEND

- Major Roads
- Highways
- - - Municipal Boundaries
- ▭ Airport Property Boundary
- ✈ Instrument approach procedure - Runway 27¹
- ✈ Missed approach procedure - Runway 27¹
- ✈ Standard instrument departure procedure - Runway 27¹
- ▲ Airspace fix²
- ⬢ VORTAC³

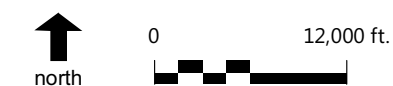

- Notes:
1. The routes shown depict approximate routes as published on National Aeronautical Charting Office charts. Actual aircraft flight tracks over the ground will vary based on air traffic control procedures, aircraft types, and weather conditions.
 2. Airspace fixes may include intersections of VOR radials and/or RNAV/GPS waypoints.
 3. VORTAC = Combined very high frequency omni-directional radio range (VOR) and Tactical Air Navigation System (TACAN) facility; RNAV = Area navigation; GPS = Global Positioning System.

Sources: Federal Aviation Administration, National Aeronautical Charting Office (published departure and arrival routes and procedures effective January 14, 2010; airspace fix and VORTAC); San Diego Geographic Information Source (SanGIS), 2008 (municipal boundaries, roads and highways)

Prepared by: Ricondo & Associates, Inc., March 2012.

Exhibit E1-4
Instrument Procedures
Runway 27

Portions of this DERIVED PRODUCT contain geographic information copyrighted by SanGIS. All Rights Reserved.

E1.2.3 Runway Use

Operations at SDIA use the runway in three different operating configurations, depending on winds, weather and visibility conditions.

- Arrivals and departures on Runway 27 (west flow)—approximately 96.5% of annual operations
- Arrivals and departures on Runway 9 (east flow) and arrivals on Runway 9, departures on Runway 27 (contra-flow)—approximately 3.5% of annual operations

West flow is the preferred operating configuration at SDIA because of prevailing winds, the relatively steep climb requirements for departures to the east, and the airfield layout. A west-flow operation optimizes the terminal and the taxiway system.

E1.2.4 Airport Activity Forecast

The most recent aviation demand forecasts for SDIA were prepared for 2030 as part of the Destination Lindbergh Study to reflect current industry trends and conditions at SDIA. Two forecasts were prepared as part of the study, which are unconstrained and constrained forecasts. The unconstrained forecast was developed to represent market-driven demand for air service, which projected the level of activity the Airport could expect if it had no constraints. Because the unconstrained forecasts are purely market-driven, facility limitations and community and environmental constraints are not considered. SDIA, however, is subject to numerous constraints and may not be able to provide the necessary facilities to accommodate the unconstrained forecast activity levels. The constrained forecast was developed to project the level of activity the Airport could accommodate without any substantial expansion to runways and airport infrastructure. The constrained forecast is considered the more realistic of the two forecasts and is the forecast scenario used for all analyses in the ALUCP.

Table E1-1 presents historical and constrained demand forecast data through 2030.

Table E1-1 SDIA Constrained Aviation Demand Forecast Summary

Year	Enplaned Passengers	Operations	Cargo & US Mail (tons)
Historical Data			
1980	2,561,678	146,691	27,590
1985	3,968,903	162,412	31,857
1990	5,609,104	212,553	68,127
1995	6,686,144	245,280	97,667
2000	7,915,899	207,644	153,370
2005	8,692,694	225,423	187,705
2010	8,456,176	190,137	127,261
Forecast Data			
2015	10,163,700	230,100	172,400
2020	11,351,200	250,700	188,200
2030	14,208,500	286,100	225,600
CAGR 2010-2030	2.6%	2.1%	2.9%

Notes: Enplaned passengers are those boarding aircraft at SDIA.

CAGR = Compound Annual Growth Rate

Sources: San Diego County Regional Airport Authority, Air Traffic Reports for various years,

http://www.san.org/sdia/at_the_airport/education/airport_statistics.aspx (accessed in February 2011); Jacobs Consultancy Team, Destination Lindbergh Technical Report, San Diego International Airport, p. 3-21, March 2009.

Prepared by: Ricondo & Associates, Inc., May 2012.



APPENDIX E

Technical Analysis

E2: Noise Compatibility Factor Technical Analysis

E2.1 Defining Noise

Noise is unwanted sound. Sound is created by variations in air pressure and is measured in terms of pressure level. The decibel (dB) scale has been developed to describe sound pressure level. Because the human ear is more sensitive to sound at specific frequencies (or pitches), special weighting scales have been developed so that sound measurements can be adjusted to accurately describe sounds that people hear. The A-weighting scale is most common. The A-weighted decibel is often indicated by "dBA." Where the context clearly indicates that the A-weighting scale is being used, as in this ALUCP, the "A" is usually dropped and the term "dB" is used.

For airport noise studies, California law requires that noise be described using the Community Noise Equivalent Level (CNEL) metric.¹ CNEL is used to describe the total noise level in a community over a 24-hour period. Scientists and engineers refer to CNEL as a "24-hour, time-weighted, cumulative noise metric." Acoustical scientists developed CNEL to aid in predicting the effects of noise on communities. CNEL describes the total noise in a 24-hour period, with the addition of 4.8 dB to evening noise events (between 7:00 p.m. and 10:00 p.m.) and 10 dB to nighttime noise (between 10:00 p.m. and 7:00 a.m.).

¹ Title 21, California Code of Regulations, Subchapter 6, *Noise Standards*, Section 5012.

The evening and nighttime weights are added because noise in those periods is more disturbing to people than daytime noise. In aircraft noise studies, CNEL is calculated for an average day during a given study year. CNEL levels are mapped as noise contours at intervals of 5 dB.

E2.2 Federal, State and Local Regulations and Guidance Related to Aircraft Noise

Since the 1960s aircraft noise has been the subject of numerous federal, state and local laws and policies aimed at reducing its impact on communities located in the vicinity of airports. These laws and policies have resulted in a wide range of programs operating at all levels of government. These programs can be classified into four broad categories:

- Programs to reduce the noise produced by aircraft
- Noise abatement programs to shift aircraft noise to areas where it will be less disturbing
- Noise mitigation programs to reduce the adverse effects of aircraft noise on noise-sensitive land uses
- Land use compatibility planning to promote the development of compatible land uses and to avoid the development of noise-sensitive land uses in high-noise areas

E2.2.1 Summary of Federal Regulations

Congress has enacted legislation over the past 40 years requiring the reduction of noise in new aircraft designs and requiring the retirement of the loudest aircraft from the civilian aircraft fleet.

Congress has also enacted legislation providing assistance to airport operators desiring to develop and implement noise compatibility plans and programs. The Federal Aviation Administration (FAA) promulgated the regulations governing this voluntary program in Title 14, Code of Federal Regulations (14 CFR) Part 150, Airport Noise Compatibility Planning. After completing a Part 150 Noise Compatibility Program (NCP), airport operators are eligible for funding assistance to implement FAA-approved measures in the NCP. SDIA recently updated its Part 150 NCP, receiving FAA approval of the updated program in 2011.²

E2.2.2 California Airport Noise Regulations

The State of California has enacted legislation to encourage the reduction of airport noise impacts and to mitigate the impact of noise on residents. Noise is generally considered the most extensive impact associated with airports because its effects are often experienced well beyond the airport boundary. Indeed, one of the specific purposes cited by the California

² The Part 150 NCP for SDIA includes policies related to the abatement of aircraft noise and the sound attenuation of existing housing within the 65 dB CNEL noise contour.

legislature in creating the airport land use compatibility planning process was to “minimize the public's exposure to excessive noise ... within areas around public airports...”³

California Code of Regulations, Title 21, Subchapter 6, describes airport noise standards developed by the California Department of Transportation (Caltrans), as directed by the state legislature in Section 21669 of the State Aeronautics Act. The regulations establish 65 dB CNEL as the “level of noise acceptable to a reasonable person residing in the vicinity of an airport.”⁴

Land uses described as incompatible with noise above 65 dB CNEL are:

- Residences (all types)
- Schools (public and private)
- Hospitals and convalescence homes
- Places of worship

According to the law, these uses are made compatible with noise above 65 dB CNEL if an aviation easement for noise is granted to the airport operator or if the buildings are sound attenuated to an indoor level of 45 dB CNEL or less in all habitable rooms.⁵

The statute explains that a “noise impact area” exists around an airport if any incompatible uses are within the 65 dB CNEL contour. Airports with noise impact areas are to establish noise monitoring programs and establish measures to reduce and ultimately eliminate the noise impact area or seek a variance.

E2.2.3 California Building Code

Title 24 of the California Code of Regulations, known as the California Building Code (CBC), sets 45 dB CNEL as the acceptable interior noise exposure for residential structures (other than detached single-family residences) and other noise sensitive land uses. In areas where airport noise exposure levels exceed 60 dB CNEL, interior spaces require sound attenuation or an acoustical analysis to demonstrate that airport noise would be attenuated to meet the 45 dB standard. The noise level is to be derived from the established ALUCP or, if an ALUCP does not exist, from the noise element of the applicable city or county general plan.⁶

E2.2.4 California Airport Land Use Planning Handbook

The *California Airport Land Use Planning Handbook* (the Handbook) prepared by Caltrans includes an extensive discussion of aircraft noise and the factors that Airport Land Use Commissions (ALUCs) should consider in establishing noise compatibility standards and criteria.

³ California Public Utilities Code §21670(a)(2).

⁴ Title 21, California Code of Regulations, Subchapter 6, *Noise Standards*, Section 5006.

⁵ Title 21, California Code of Regulations, Subchapter 6, *Noise Standards*, Section 5014.

⁶ California Building Code, Title 24, Part 2, Chapter 12, Section 1207.11.3, *Airport Noise Sources*.

Those factors are:

- Background noise levels in the community – aircraft noise at any given level can be more disturbing in communities with low ambient noise levels than in louder urban settings
- Previous community experience with the noise source and community attitudes toward aircraft noise – the introduction of new noise sources can be particularly disturbing to many residents

The Handbook suggests that the 60 dB CNEL is an acceptable compatibility threshold at most airports. It is particularly appropriate in mild climates where windows are often open.⁷

E2.3 Technical Analysis

For the purposes of land use planning, the noise technical analysis included the development of 2030 forecast noise contours. The noise contours were developed using the FAA-approved Integrated Noise Model (INM), Version 7.0a, the standard tool for airport noise analysis. The INM input file developed for the recent 14 CFR Part 150 Noise Compatibility Study was used as the starting point for the 2030 forecast noise exposure analysis.⁸ The INM input file was edited to include the 2030 forecast operations and aircraft fleet mix, by time-of-day.

The original file included the following variables:

- Airport altitude and mean annual temperature
- Runway layout (runway end location, runway end elevation, length, displaced threshold dimensions)
- Aircraft flight track definitions
- Aircraft approach and departure climb profiles
- Runway use and flight track utilization by aircraft type

In addition to these operational variables, the INM uses a digital terrain file representing the topography of the land in the area around the airport. This allows the calculated noise levels to accurately reflect the distance of aircraft from the varying ground surface elevations in the area.

⁷ California Department of Transportation, Division of Aeronautics, *California Airport Land Use Planning Handbook*, October 2011, p. 4-7.

⁸ Harris Miller Miller and Hanson, Inc., *San Diego International Airport Part 150 Update, Noise Exposure Maps*, August 2009.

Table E2-1 summarizes the 2030 constrained activity forecast prepared for the Destination Lindbergh study, the most recent official activity forecasts for the Airport.⁹

Table E2-1 SDIA Constrained Operations Forecast Summary

Category	Air Carrier	Commuter	Air Cargo	Civil	Military	Total
2030 Forecast Operations	237,900	16,500	7,800	23,700	200	286,100

Notes:

Air Carrier: Commercial passenger operations by aircraft seating more than 60 passengers

Commuter: Commercial passenger operations by aircraft seating 60 or fewer passengers

Air Cargo: Operations by all-cargo aircraft

Civil: Operations classified as air taxi (on-demand operators certified under 14 CFR Part 135) and not included in either the commuter or air cargo categories; general aviation operations

Military: Operations by military aircraft

Source: Jacobs Consultancy Team, Destination Lindbergh Technical Report, San Diego International Airport, March 2009, p. 3-21.

Prepared by: Ricondo & Associates, Inc., May 2012.

Table E2-2 presents a detailed account of the 2030 forecast of arrivals and departures by aircraft type and time-of-day. **Table E2-3** presents the detailed forecast by aircraft type and runway used.

The INM noise modeling process produced a digital output file of noise levels throughout the area of analysis. Before plotting the noise compatibility boundary map, the output file was adjusted to reflect an unusual condition on the hillside east of Interstate 5 (I-5) between Laurel and Washington Streets, north of the east end of the runway. This hillside has a direct line of sight to the east end of Runway 27 and is exposed to noise from the breakaway thrust of departing aircraft without benefiting from ground absorption or shielding of noise by intervening structures. This localized phenomenon has been called a "hill effect."

⁹ Jacobs Consultancy Team, Destination Lindbergh Technical Report, San Diego International Airport, March 2009, p. 3-21.

Table E2-2 Annual Operations by Aircraft Type and Time-of-Day, SDIA: 2030 Constrained Forecast

Aircraft Type	Aircraft Model	Number of Arrivals			Number of Departures		
		Day	Evening	Night	Day	Evening	Night
Jet	Airbus A300-622R	525	11	422	288	430	239
	Airbus A310-304	223	2	267	16	269	208
	Airbus A319-131	304	65	2	303	3	63
	Airbus A320	13,418	5,149	2,134	14,533	2,295	3,874
	Airbus A321-232	2,357	1,617	517	3,110	757	624
	Airbus A330-301	8	944	36	980	6	2
	Boeing 737-300	16,035	4,132	1,316	16,255	4,235	994
	Boeing 737-400	13	13	7	22	4	6
	Boeing 737-700	24,394	6,733	3,040	26,600	5,342	2,224
	Boeing 737-800	18,087	5,760	4,117	22,070	1,629	4,264
	Boeing 757-200	561	5	9	552	18	5
	Boeing 767-200	340	279	310	518	313	98
	Boeing 767-300	2,853	1,298	699	3,645	298	906
	Boeing 777-300	76	5	70	64	72	14
	Cessna Citation 2	960	95	52	947	109	51
	Cessna Citation 3	403	48	14	408	37	21
	Cessna Citation 550B	33	0	0	19	3	11
	Cessna Citation X	636	72	33	654	51	36
	Challenger 600/601	976	63	40	964	69	45
	Embraer 145 ER	2,700	543	251	2,764	384	345
	Dassault Falcon 20	27	0	0	24	2	1
	Dassault Falcon 50	79	12	7	91	6	1
	Dassault Falcon 900	98	14	2	106	5	4
	Gulfstream GII	20	11	2	30	3	0
	Gulfstream GIIIB	96	12	8	103	10	4
	Gulfstream GIV	367	43	20	374	33	23
	Gulfstream GV	3,026	342	678	3,148	668	230
	Israel IAI-1125 Astra	574	77	27	596	48	34
	Lear 25	43	3	0	45	1	0
	Lear 36	1,005	91	67	1,022	97	45
	Mitsubishi Diamond	2,777	285	137	2,835	241	122
	Other Jet	27	12	9	32	6	9
	Twin Turboprop		3,938	744	343	3,777	980
Twin Piston		223	17	9	204	27	17
Single Engine Piston		2,483	157	66	2,269	194	244
Total Operations		99,686	28,654	14,711	109,369	18,645	15,035
Percentages		34.8%	10.0%	5.1%	38.2%	6.5%	5.3%

Note: Totals may not sum as indicated due to rounding.

Sources: Ricondo and Associates, Inc., Brown-Buntin Associates, August 2009 (operations by aircraft type and runway developed based on constrained activity forecasts prepared for Destination Lindbergh (Landrum & Brown, Jacobs Consultancy Team, Destination Lindbergh, Aviation Activity Forecast, February 2009) and INM modeling parameters from Part 150 Study Update (HMMH, San Diego International Airport Part 150 Update, Noise Exposure Maps, August 2009).

Prepared by: Ricondo & Associates, Inc., May 2012.

Table E2-3 Annual Operations by Aircraft Type and Runway Used, SDIA: 2030 Constrained Forecast

Aircraft Type	Aircraft Model	Number of Arrivals		Number of Departures		Totals
		Runway 9	Runway 27	Runway 9	Runway 27	
Jet	Airbus A300-622R	41	916	5	953	1,915
	Airbus A310-304	211	282	7	485	985
	Airbus A319-131	6	364	2	368	740
	Airbus A320-200	277	20,423	150	20,550	41,400
	Airbus A321-232	75	4,416	47	4,445	8,983
	Airbus A330-301	14	974	17	971	1,976
	Boeing 737-300	317	21,167	199	21,284	42,967
	Boeing 737-400	0	32	0	32	64
	Boeing 737-700	634	33,532	360	33,806	68,332
	Boeing 737-800	352	27,612	205	27,758	55,927
	Boeing 757-200	14	560	6	569	1,149
	Boeing 767-200	27	902	9	920	1,858
	Boeing 767-300	83	4,767	44	4,806	9,700
	Boeing 777-300	10	140	3	148	301
	Cessna Citation 2	16	1,091	12	1,095	2,214
	Cessna Citation 3	5	460	5	460	930
	Cessna Citation 550 B	0	33	1	32	66
	Cessna Citation X	9	732	3	738	1,482
	Challenger 600/601	10	1067	8	1069	2,154
	Embraer 145 ER	44	3,449	30	3,463	6,986
	Dassault Falcon 20	0	27	1	25	53
	Dassault Falcon 50	1	97	1	97	196
	Dassault Falcon 900	0	115	1	114	230
	Gulfstream GII	1	33	0	33	67
	Gulfstream GIIB	3	113	0	116	232
	Gulfstream GIV	9	422	5	426	862
	Gulfstream GV	71	3,975	45	4,002	8,093
	Israel IAI-1125 Astra	16	661	7	670	1,354
	Lear 25	0	46	0	46	92
	Lear 35	25	1,138	14	1,150	2,327
	Mitsubishi Diamond	46	3,153	29	3,169	6,397
	Other Jet	1	47	2	45	95
Twin Turboprop		69	4,959	37	4,991	10,056
Twin Piston		15	234	12	238	499
Single-Engine Piston		238	2,469	182	2,424	5,413
Totals		2,640	140,410	1,449	141,600	286,100
Percentages		0.9%	49.1%	0.5%	49.5%	100%

Note: Totals may not sum as indicated due to rounding.

Sources: Ricondo and Associates, Inc., Brown-Buntin Associates, August 2009 (operations by aircraft type and runway developed based on constrained activity forecasts prepared for Destination Lindbergh (Landrum & Brown, Jacobs Consultancy Team, Destination Lindbergh, Aviation Activity Forecast, February 2009) and INM modeling parameters from Part 150 Study Update (HMMH, San Diego International Airport Part 150 Update, Noise Exposure Maps, August 2009).

Prepared by: Ricondo & Associates, Inc., May 2012.

The overall contour pattern, with long and very narrow contours on the east and much broader and somewhat shorter contours on the west, reflects the predominant west flow runway use pattern at the Airport. Caltrans Division of Aeronautics has approved the incorporation of the “hill effect” into the INM model to create the 2030 noise contour map, as shown in **Exhibit E2-1** (see **Appendix F** of this ALUCP).

Exhibits E2-2 and **E2-3** depict the 2030 forecast noise contours with existing land use and the City of San Diego’s General Plan land use designations. The exhibits also identify community planning areas and neighborhood boundaries. The exhibits indicate that a considerable amount of existing residential land use, including single-family and multi-family housing, is exposed to aircraft noise above 65 dB CNEL. Several schools and other noise-sensitive institutions are also currently exposed to aircraft noise. Very little undeveloped land remains in the noise contours. The General Plan land use designations are similar to the existing land use pattern, reflecting the City’s objective to preserve the existing development patterns in those areas.

E2.4 Noise Compatibility Policy Considerations

The basic objective of the noise compatibility policies and standards of the updated ALUCP is to ensure that new development within the noise compatibility boundary (the 2030 noise contours) is compatible with the level of noise to which it is exposed.

The noise policies and standards in this ALUCP are part of a comprehensive set of federal, state, and San Diego County Regional Airport Authority (SDCRAA) policies, programs, and regulations intended to reduce the impact of airport noise. While this ALUCP addresses these impacts through land use planning, other programs involve:

- Retirement of the loudest aircraft from the civilian aircraft fleet
- Aircraft and engine design
- Aircraft operating procedures
- Noise abatement and mitigation programs

In setting noise compatibility policies and standards within the noise compatibility boundary (the 2030 noise contours), several existing conditions must be recognized.

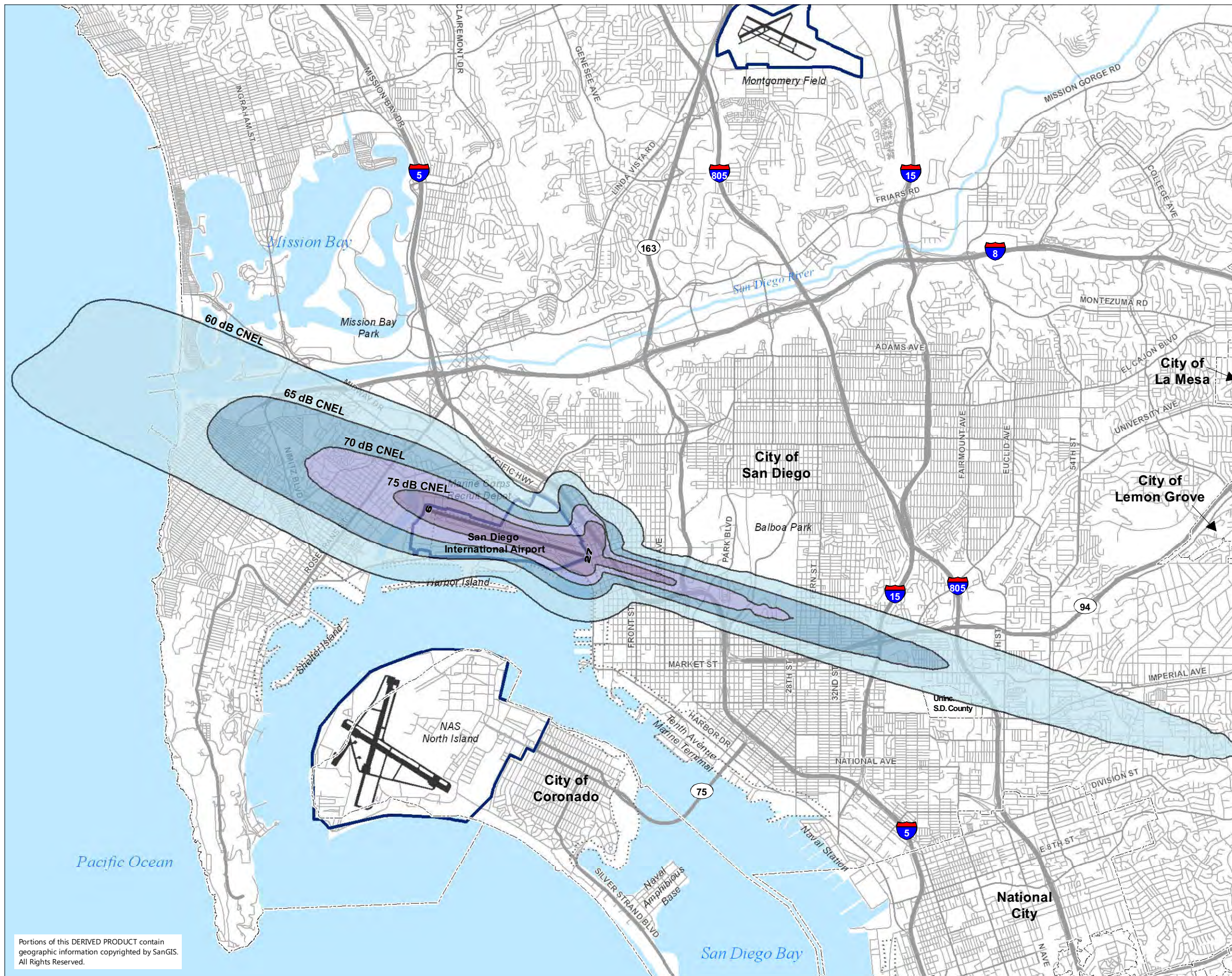

LEGEND

- Major Roads
- Highways
- - - Municipal Boundaries
- ▭ Airport Property Boundary
- ▭ San Diego Unified Port District
- ▭ Planning Jurisdiction Boundary

Proposed Forecast Noise Exposure Ranges:

- ▭ 60 - 65 dB CNEL
- ▭ 65 - 70 dB CNEL
- ▭ 70 - 75 dB CNEL
- ▭ 75 + dB CNEL



Notes: 1. CNEL = Community Noise Equivalent Level
 2. Based on 2030 Forecast Noise Exposure.

Sources: San Diego Geographic Information Source (SanGIS), 2008 and 2011 (municipal boundaries, roads and highways); Harris Miller Miller & Hanson Inc., 2010 (forecast noise exposure ranges).

Prepared by: Ricondo & Associates, Inc., July 2012.

**Exhibit E2-1
 Proposed Noise Contour Map**

Portions of this DERIVED PRODUCT contain geographic information copyrighted by SanGIS. All Rights Reserved.

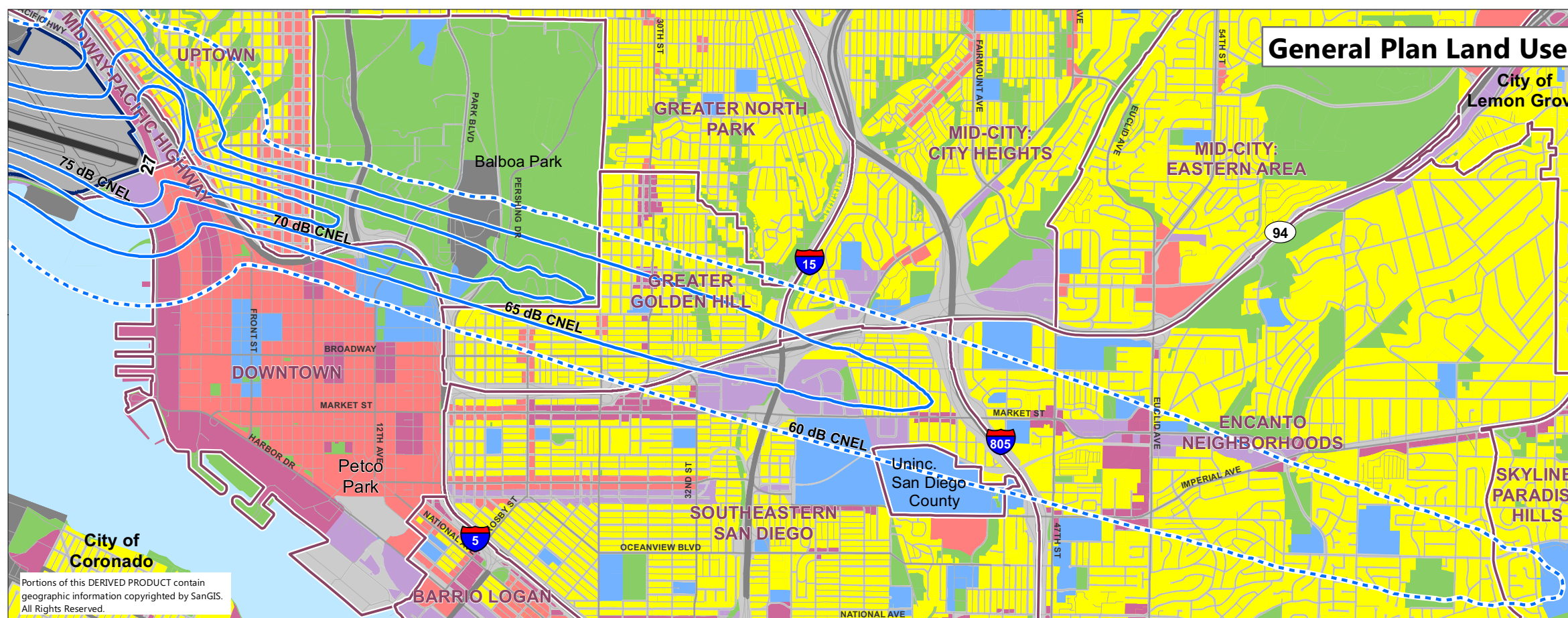
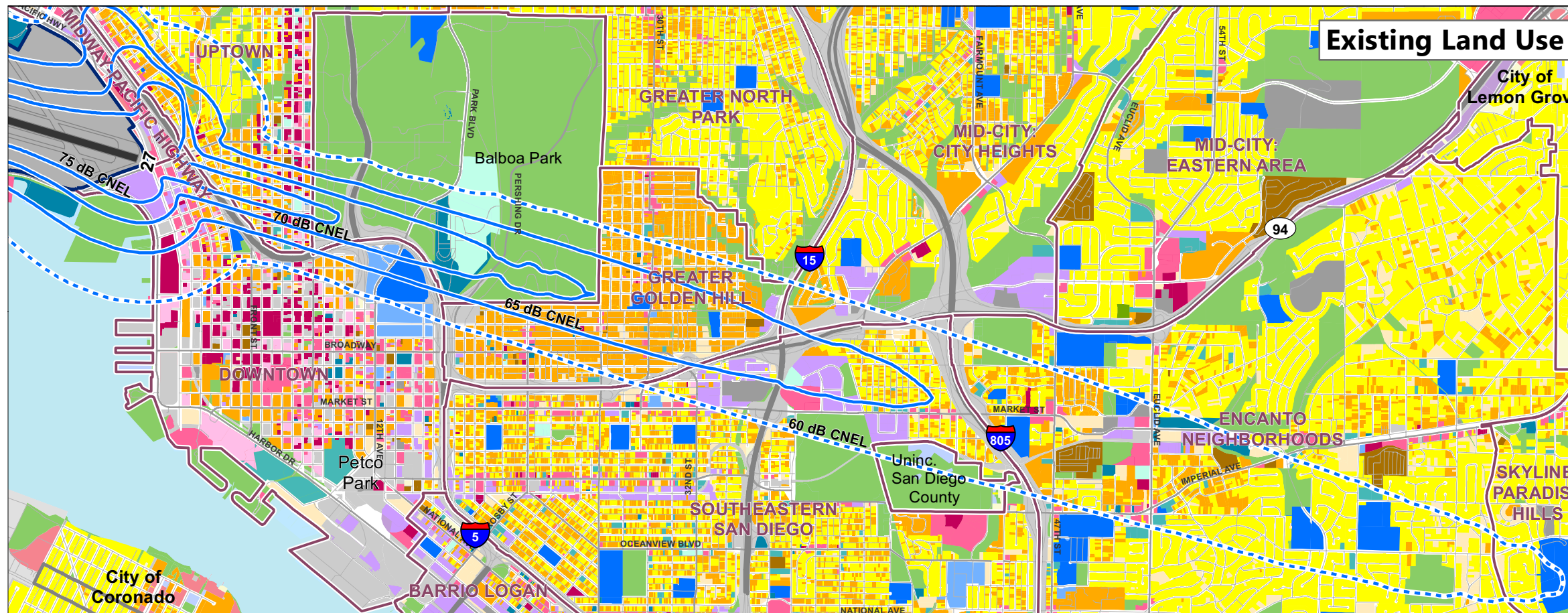

LEGEND

- Major Roads
- Highways
- ▭ Airport Property Boundary
- ▭ Community Planning Areas
- ▭ Forecast Noise Contours
- ▭ 60 dB CNEL Noise Contour

Existing Land Use

- ▭ Residential - Single Family
- ▭ Residential - Multi-Family
- ▭ Group Quarters
- ▭ Commercial - Guest
- ▭ Lodging
- ▭ Commercial
- ▭ Office
- ▭ Industrial
- ▭ Hospital and Healthcare Facilities
- ▭ Institutional - Assembly
- ▭ Institutional - Other
- ▭ School (K-12), Children's Day Care Center
- ▭ University/College/Trade School
- ▭ Open Space, Parks, Recreation
- ▭ Agriculture
- ▭ Transportation
- ▭ Utilities
- ▭ Other - Under Construction
- ▭ Vacant
- ▭ Water

General Plan Land Use

- ▭ Residential
- ▭ Commercial
- ▭ Industrial
- ▭ Mixed Use
- ▭ Institutional - Services
- ▭ Institutional - Utilities
- ▭ Institutional - Military Use
- ▭ School
- ▭ Open Space
- ▭ Transportation
- ▭ Water
- ▭ Planned Development



Sources: San Diego Geographic Information Source (SanGIS), 2008 and 2011 (municipal boundaries, roads and highways); Harris Miller Miller & Hanson Inc., 2010 (forecast noise exposure ranges); City of San Diego, August 2011 (neighborhood boundaries); Ricondo & Associates, Inc., January 2011, based on GIS datasets received from the City of San Diego, SanGIS and San Diego Association of Governments (SANDAG) GIS datasets were updated based on field surveys conducted in July and November 2011).

Prepared by: Ricondo & Associates, Inc., March 2012.

**Exhibit E2-2
2030 Noise Exposure,
Existing and General Plan Land Uses
Eastside**

Portions of this DERIVED PRODUCT contain geographic information copyrighted by SanGIS. All Rights Reserved.

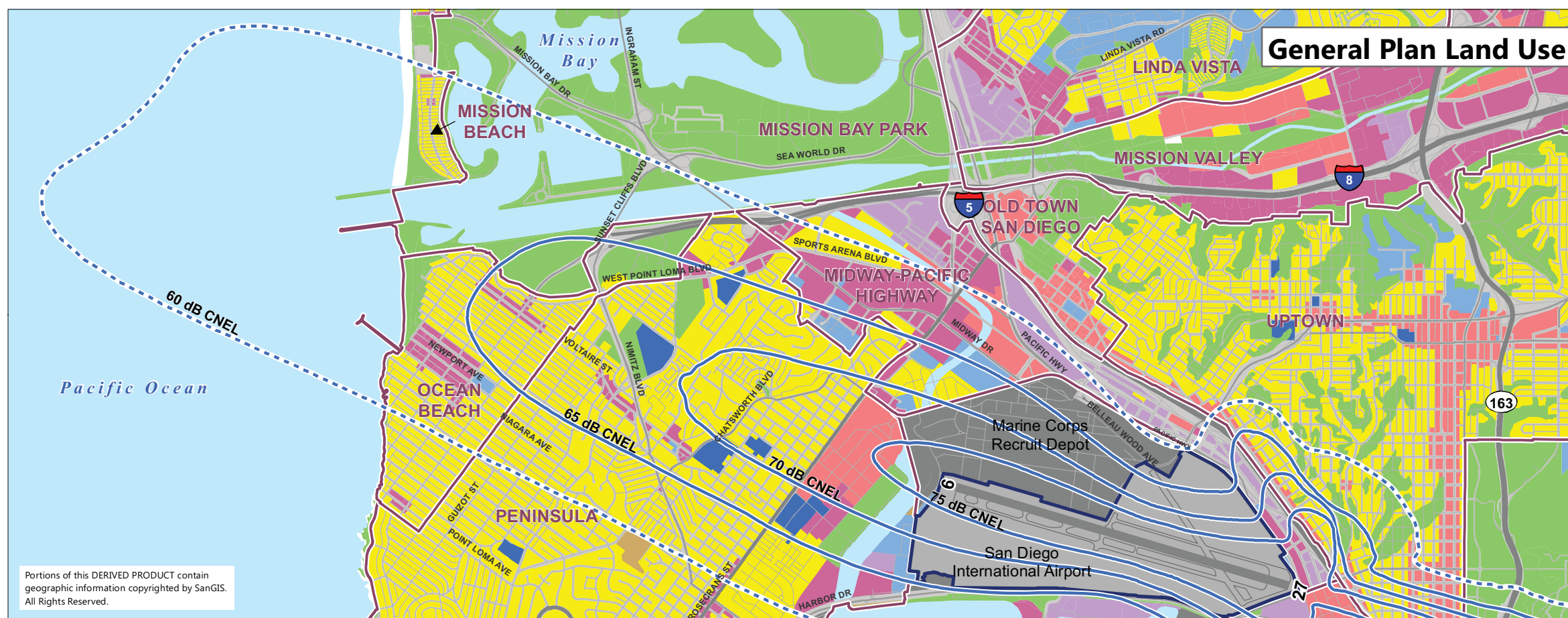
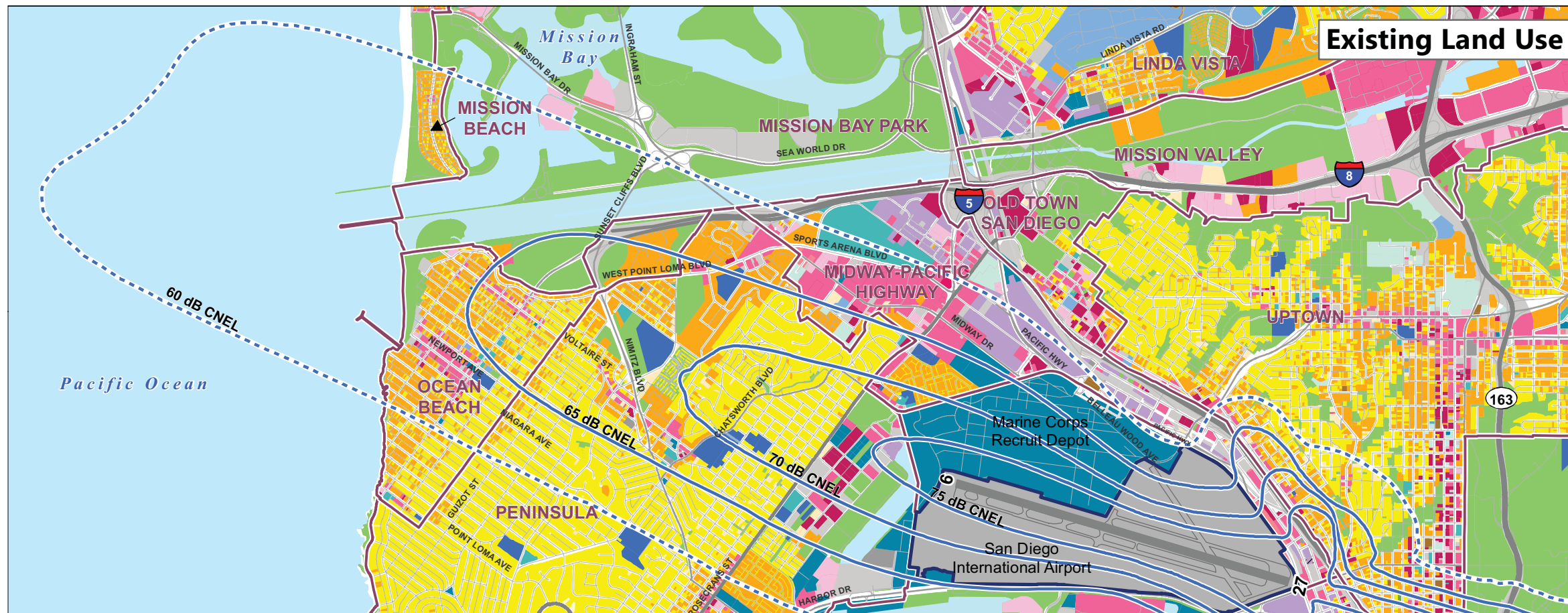

LEGEND

- Major Roads
- Highways
- ▭ Airport Property Boundary
- ▭ Community Planning Areas
- ▭ Forecast Noise Contours
- ▭ 60 dB CNEL Noise Contour

Existing Land Use

- ▭ Residential - Single Family
- ▭ Residential - Multi-Family
- ▭ Group Quarters
- ▭ Commercial - Guest Lodging
- ▭ Commercial
- ▭ Office
- ▭ Industrial
- ▭ Hospital and Healthcare Facilities
- ▭ Institutional - Assembly
- ▭ Institutional - Other
- ▭ School (K-12), Children's Day Care Center
- ▭ University/College/Trade School

General Plan Land Use

- ▭ Residential
- ▭ Commercial
- ▭ Industrial
- ▭ Mixed Use
- ▭ Institutional - Services
- ▭ Institutional - Utilities
- ▭ Institutional - Military Use
- ▭ School
- ▭ Open Space
- ▭ Transportation
- ▭ Water
- ▭ Planned Development

- ▭ Open Space, Parks, Recreation
- ▭ Agriculture
- ▭ Transportation
- ▭ Utilities
- ▭ Other - Under Construction
- ▭ Vacant
- ▭ Water



Sources: San Diego Geographic Information Source (SanGIS), 2008 and 2011 (municipal boundaries, roads and highways); Harris Miller Miller & Hanson Inc., 2010 (forecast noise exposure ranges); City of San Diego, August 2011 (neighborhood boundaries); Ricondo & Associates, Inc., January 2011, based on GIS datasets received from the City of San Diego, SanGIS and San Diego Association of Governments (SANDAG) (GIS datasets were updated based on field surveys conducted in July and November 2011).

Prepared by: Ricondo & Associates, Inc., March 2012.

**Exhibit E2-3
2030 Noise Exposure,
Existing and General Plan Land Uses
Westside**

Portions of this DERIVED PRODUCT contain geographic information copyrighted by SanGIS. All Rights Reserved.

The noise compatibility policies and standards of this ALUCP should be consistent with the following conditions, established programs and policies.

- The area within the forecasted 2030 noise contours is nearly fully developed.
- The noise-impacted area includes noise-sensitive land uses.
- Most of the noise-impacted residential neighborhoods are well established and neighborhood preservation is valued by residents.
- In the past, the City established redevelopment areas in parts of the noise-impacted area to stimulate redevelopment, including mixed-use development with housing. The City's current General Plan, and the policies contained in the Economic Prosperity Element, designate employment land in key areas in parts of the noise-impacted area in order to retain an adequate supply of land appropriate for future economic development. Employment land includes land utilized by industrial, commercial, service, and commercial retail users.¹⁰
- SDCRAA has made significant investments in the noise-impacted area through its Quieter Home Program, which is specifically intended to improve neighborhood livability and, ultimately, to meet the goal of the state Noise Law – to achieve land use compatibility within the 65 dB CNEL contour.

In recognition of the objectives of this ALUCP, noise policies and the existing conditions in the SDIA area, four principles were identified as the basis for updated noise compatibility policies and standards:

1. The standards should set reasonable limits on the amount of new noise-sensitive development that can occur in the noise-impacted area.
2. The standards should be based on guidance established in state law or provided by other authoritative sources, including the Handbook and 14 CFR Part 150.
3. The standards should avoid being so restrictive as to create disincentives to community investment that might lead to future blight.
4. The standards should ensure that any new noise-sensitive development includes sound attenuation to reduce interior noise levels to acceptable levels and that aviation easements are granted to the airport operator in accordance with the state Noise Law (Title 21).

The noise compatibility policies and standards in **Chapter 3** of this ALUCP were developed in recognition of these principles. They ensure that any new development within the noise compatibility boundary would be compatible with the noise levels to which they are exposed. The 60 dB CNEL contour is the threshold of noise compatibility. New residential uses exposed to noise above 60 dB CNEL would require sound attenuation to ensure interior noise levels

¹⁰ City of San Diego, *General Plan, Economic Prosperity Element*, March 10, 2008.

consistent with the CBC requirements (45 dB CNEL). At levels above 65 dB CNEL, new residences and other noise-sensitive development would require sound attenuation to ensure compliance and consistency with the State Noise Law. Within the 70 dB CNEL noise contour, sound attenuation measures would be required for various nonresidential uses to achieve interior noise levels (50 dB CNEL) consistent with guidance provided in 14 CFR Part 150 (Appendix A, Table 1).



APPENDIX E

Technical Analysis

E3: Safety Compatibility Factor Technical Analysis

E3.1 Defining Safety Compatibility

Safety compatibility refers to land use policies intended to reduce the consequences of aircraft accidents within areas where the potential risk of accidents is a concern. The safety compatibility factor is based on delineated safety zones, per the California Department of Transportation (Caltrans) guidance, which are identified using aeronautical considerations such as runway configuration, approach and departure procedures, and other factors that determine where aircraft fly and where potential accidents could occur.

E3.2 Federal Guidance

The federal government does not have direct jurisdiction over local land use planning or approval of land use plans, regulations and projects. There are, however, federal standards that require land use restrictions related to safety on airport property near the runway for airports receiving federal funding.¹

These standards have been developed to minimize hazards associated with the most common kinds of aircraft accidents and incidents—those involving overruns and excursions from runways and taxiways.

Federal Aviation Administration (FAA) Advisory Circular 150/5300-13A "Airport Design" contains object clearing criteria intended to ensure safe and efficient airport operations. These criteria call for zones and areas "are clear of objects or restricted to objects with a certain function, composition, and/or height."²

¹ Federal Aviation Administration, Advisory Circular 150/5300-13A, *Airport Design*, Paragraph 310.

² Federal Aviation Administration, Advisory Circular 150/5300-13A, *Airport Design*, Paragraph 306.

Accordingly, certain objects, land use types or characteristics should be either permissible or avoided within zones and areas associated with an airport runway or taxiway system. These zones and areas are described below.

- Runway Protection Zones (RPZs) are two-dimensional trapezoid-shaped areas defined off the ends of runways. The FAA advises airports to acquire RPZs and, if possible, clear all objects from the RPZs. If that is not practicable, land use controls should be adopted to prohibit housing, places of public assembly, and fuel facilities.
- Obstacle Free Zones (OFZs) are three dimensional rectangular-shaped zones centered on the runway or taxiway centerlines, with specific lengths, widths and surface elevations based on the type of runway/taxiway. The OFZs clearing standards preclude object penetrations unless they are frangible visual navigational aids (NAVAIDS).
- Runway Safety Areas (RSAs) are two-dimensional rectangular-shaped areas centered on the runway centerlines, with specific lengths and widths which depend on the airplane design groups and approach categories of aircraft intended to operate on the airfield. RSAs shall be cleared and graded with no potentially hazardous ruts, humps, depressions, or other surface variations. The design standards listed in Paragraph 307 of Advisory Circular 150/5300-13A "Airport Design" contain strict standards for grade, compaction, drainage, and object frangibility. No objects higher than three inches above grade are permitted in the RSAs, unless they are deemed acceptable because of their function and constructed on frangible mounted structures.
- Object Free Areas (OFAs) are two-dimensional rectangular-shaped areas centered on the runway or taxiway centerlines, with specific lengths and widths which depend on the airplane design groups intended to operate on the airfield. The OFA provides additional areas around the RSA that is clear of objects that could cause damage to an aircraft overrunning or veering off the runway. Therefore, objects located within the OFAs must not protrude the RSA surface elevations. Only objects directly related to air navigation or aircraft maneuvering purposes are allowed within these areas.

At San Diego International Airport (SDIA), most of the area within the RPZs, OFZs, RSAs, and OFAs are within airport property. Exceptions include small areas located within a thousand feet of the west end of Runway 9-27 under the RSA and OFA, and small areas under the RPZ off the east end of Runway 9-27. These areas are depicted on **Exhibit E3-1**.

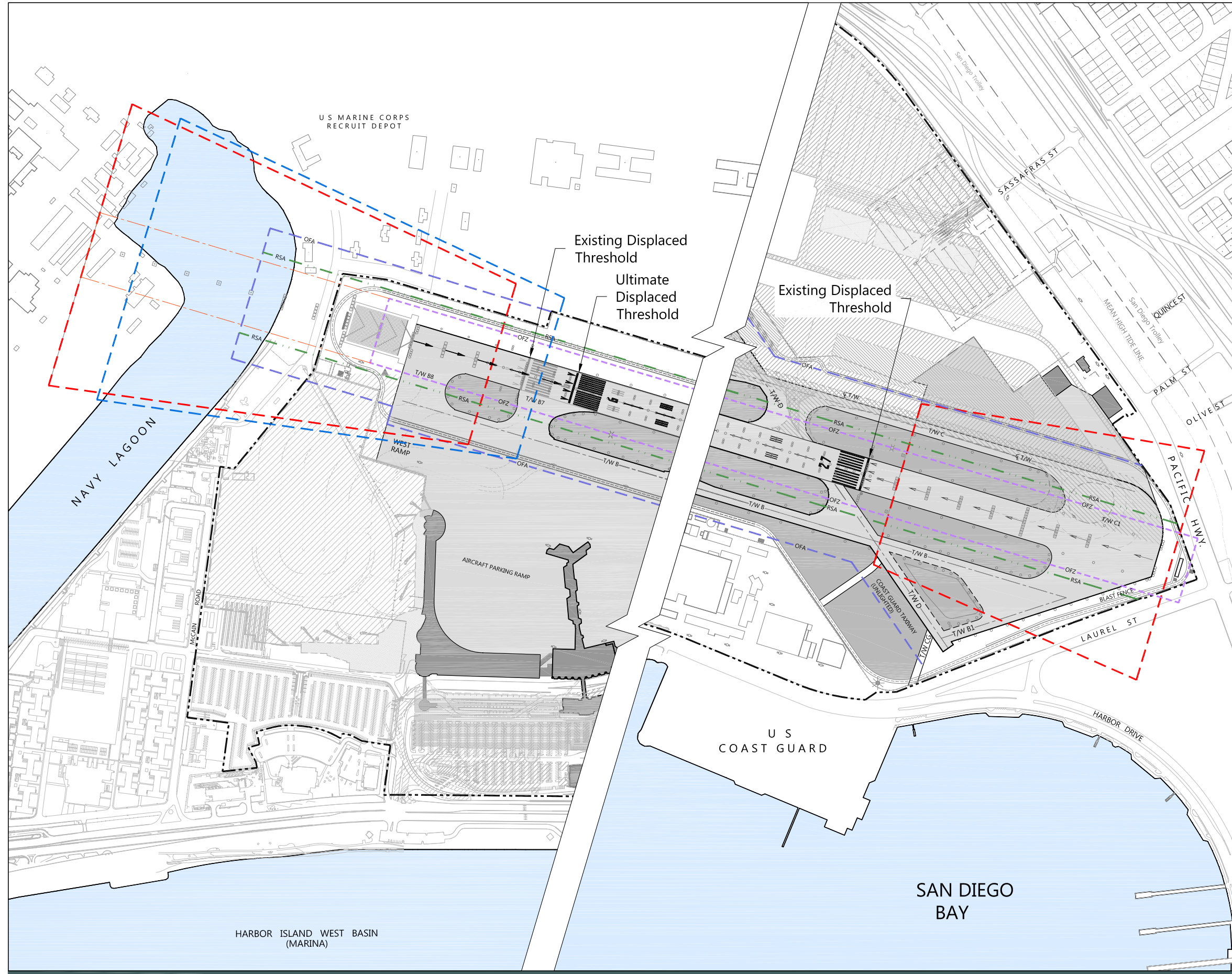

- LEGEND**
- Object Free Area (OFA)
 - - - Runway Obstacle Free Zone (OFZ)
 - Runway Safety Area (RSA)
 - - - Existing Runway Protection Zone (RPZ)
 - - - Future Runway Protection Zone (RPZ)
 - - - Existing Airport Property Line

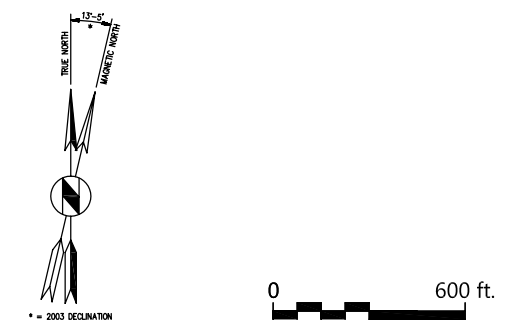

Note: Airport Elevation is 16.8 feet above mean sea level (MSL).

Source: Ricondo & Associates, Inc., September 2011, based on San Diego County Regional Airport Authority, Airport Layout Plan July 10, 2009 (runway object free area, runway obstacle free zone, runway safety area, runway protection zone, and existing airport property line).
 Prepared by: Ricondo & Associates, Inc., December 2013.

Exhibit E3-1

SDIA Runway and Taxiway Design

E3.3 State Regulations and Guidance

E3.3.1 State Education Code

The California Education Code, Section 17215, restricts school districts and charter schools from purchasing or leasing school sites within two nautical miles of an existing or planned runway. School boards considering such sites must notify the State Department of Education, which informs Caltrans.

Caltrans has 30 days to investigate the site and issue a report with a recommendation on the acquisition proposal. If Caltrans does not support the site acquisition, the school board or charter school may not acquire the site for school development. If Caltrans supports the acquisition, the school board or charter school may acquire the site, after holding a public hearing.

E3.3.2 State of California Guidance

Caltrans has prepared *the California Airport Land Use Planning Handbook* (the Handbook) as required by state law.³ The law requires that Airport Land Use Commissions (ALUCs) be guided by the Handbook in developing airport land use compatibility plans and policies. See **Chapter 1** of this ALUCP for additional background information.

The Handbook discusses the importance of the concept of risk in defining airport safety compatibility zones and land use policies. Risk is the product of two factors – (1) the probability of an aircraft accident at any location and (2) the consequences if an accident should one occur. The components of risk vary based on the operations at any given airport. Accidents tend to be much more common among light general aviation aircraft than commercial air carrier aircraft, for example. The consequences of light aircraft accidents, however, are much less severe for light aircraft than for commercial aircraft. Indeed, the consequences of air carrier accidents can be quite severe given the size of the aircraft, the large quantities of fuel they can carry, and their relatively high speeds.

The Handbook provides specific guidance for defining airport safety compatibility zones and policies.⁴ It also presents the geometry of safety zones for large air carrier airports. The geometric configuration of the Caltrans safety compatibility zones is based on near-airport aircraft accident location patterns and aeronautical data including aircraft flight patterns and runway length. Each safety zone has a unique character based on the general probability of aircraft accidents in the zone. The safety zones are configured assuming straight-in and straight-out arrivals and departures, with approach visibility minimums of less than three quarters of a mile.

³ California Public Utilities Code §21674.7.

⁴ California Department of Transportation, Division of Aeronautics, *California Airport Land Use Planning Handbook*, October 2011, pp. 3-16 – 3-26, 4-15 – 4-34.

Five safety compatibility zones depicted in **Exhibit E3-2** apply to large air carrier airports like SDIA.⁵

- Safety Zone 1: Includes the Runway Protection Zone (RPZ) and Object Free Area (OFA) defined by the FAA⁶
- Safety Zone 2: Inner Approach/Departure Zone
- Safety Zone 3: Inner Turning Zone
- Safety Zone 4: Outer Approach/Departure Zone
- Safety Zone 5: Sideline Zone

At general aviation airports, the Handbook advises the designation of a sixth safety zone, a Traffic Pattern Zone. This is an area subject to frequent low altitude overflights by aircraft in the local traffic pattern. Much of this activity is associated with touch-and-go takeoffs and landings, a common flight training exercise for general aviation activity. At major air carrier airports, including SDIA, little to no local traffic pattern activity occurs because of the heavy use of the airport by large, high performance jet aircraft. Thus, the Handbook recognizes that traffic pattern zones are frequently unnecessary at commercial airports.

Table E3-1 describes the nature of aircraft activity within each of the safety zones.

Table E3-1 Nature of Aircraft Activity within Each Safety Zone

Safety Zones	Aircraft Activity
Safety Zone 1: Runway Protection Zone	Aircraft on final approach or departure
Safety Zone 2: Inner Approach/Departure Zone	Aircraft at low altitudes on final approach and straight-out departures
Safety Zone 3: Inner Turning Zone	Aircraft initiating turn to en-route direction on departure
Safety Zone 4: Outer Approach/Departure Zone	Aircraft on instrument approaches and straight-out departures
Safety Zone 5: Sideline Zone	Not normally overflowed; primary risk is with aircraft losing directional control on takeoff due to excessive crosswind gusts or loss of one engine

Source: Ricondo & Associates, Inc., August 2011 based on *California Airport Land Use Planning Handbook* Figures 4B through 4F (descriptions of aircraft activity).

Prepared by: Ricondo & Associates, Inc., May 2012.

⁵ California Department of Transportation, Division of Aeronautics, *California Airport Land Use Planning Handbook*, October 2011, pp. 3-19 – 3-26, 4-19 – 4-24.

⁶ Federal Aviation Administration, Advisory Circular 150/5300-13A, *Airport Design*, Paragraph 310.

Legend

- 1. Runway Protection Zone
- 2. Inner Approach/Departure Zone
- 3. Inner Turning Zone
- 4. Outer Approach/Departure Zone
- 5. Sideline Zone

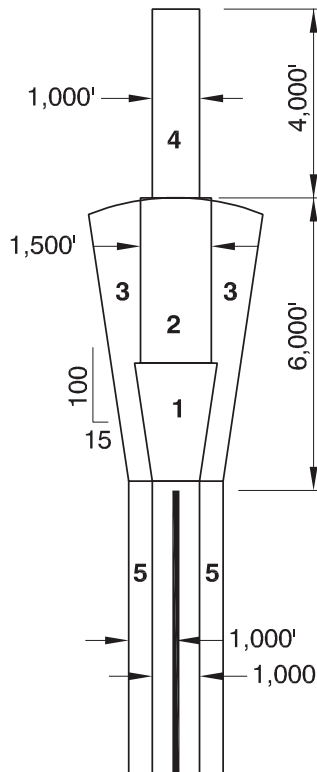

Large Air Carrier Runway

Assumptions:

- Minimal light-aircraft general aviation activity
- Predominately straight-in and straight-out flight routes
- Approach visibility minimums < 3/4 mile
- Zone 1 = 1,000' x 1,750' x 2,500'

Notes:

- 1. RPZ (Zone 1) size in the large air carrier runway example is as indicated by FAA criteria for the approach type assumed. Adjustment may be necessary if the approach type differs.
- 2. See Figure 3A for factors to consider regarding other possible adjustments to these zones to reflect characteristics of a specific airport runway.
- 3. See Figures 4B through 4G for guidance on compatibility criteria applicable with each zone.

These examples are intended to provide general guidance for the establishment of airport safety compatibility zones. They do not represent California Department of Transportation standards or policy.

Source: State of California, Department of Transportation, Division of Aeronautics, *California Airport Land Use Planning Handbook*, Figure 3B, p. 3-19, October 2011.

Prepared by: Ricondo & Associates, Inc., March 2012.



Exhibit E3-2

**Safety Compatibility Zone Example
Large Air Carrier Runway**

The Handbook includes a technical appendix with an analysis of the location of aircraft accidents in the immediate vicinity of airports.⁷ The analysis indicates that aircraft accidents occur most frequently in the immediate runway environment. The pattern becomes less dense as distance from the runway and the extended runway centerline increases.

Land use policies and standards within the safety zones should be intended to reduce the adverse consequences of accidents. In addressing the adverse consequences of accidents, land use restrictions focus on uses that are intrinsically hazardous (such as above-ground fuel storage and hazardous materials processing), uses that are vital to community health and safety (such as power plants and water and sanitary sewage treatment plants), and uses occupied by populations considered to be especially vulnerable. Vulnerable populations include those requiring assistance or supervision to evacuate in case of emergency, including children, hospitalized patients, and institutionalized persons.

In addition, safety compatibility criteria address the density or intensity of occupancy of land uses. The idea is that in areas of accident risk, uses attracting fewer people should be encouraged and those attracting dense concentrations of people avoided.

The 2011 Handbook provides a four-way classification of land uses for each safety zone, as follows:

- Normally Allowed: use is acceptable
- Limited: use is acceptable only if density/intensity restrictions are met
- Avoided: use generally should not be permitted unless no feasible alternative is available
- Prohibited: use should not be permitted under any circumstances⁸

For uses that should be “limited” within a safety zone, the Handbook provides suggested limits on the number of people occupying land uses in the zone.

- For residential uses, these limits are expressed in terms of dwelling unit density – the number of dwellings per acre
- For nonresidential uses, the limits are expressed in terms of “intensity” – the average number of people occupying the land use per acre

The suggested land use restrictions are more restrictive in the safety zones subject to greater probabilities of accident. Recognizing that uniform criteria applying equally within areas of widely varying development patterns would be of little practical value, the Handbook provides a range of criteria for consideration in areas with different levels of urban development.

⁷ In the updated 2011 Handbook, more recent data for general aviation accidents have been added to the accident location database developed by Caltrans. See California Department of Transportation, Division of Aeronautics, *California Airport Land Use Planning Handbook*, Appendix E “Aircraft Accident Characteristics”, October 2011.

⁸ California Department of Transportation, Division of Aeronautics, *California Airport Land Use Planning Handbook*, October 2011, p 4-18.

The Handbook provides suggested housing density and nonresidential intensity levels for three generalized settings:

- Rural: areas where the predominant land uses are natural or agricultural; buildings are widely scattered
- Suburban: areas characterized by low-rise (1-2 story) development and surface parking lots
- Urban: areas characterized by mid-rise (up to 5 stories) development; generally surface vehicle parking, but potentially some parking structures
- Dense urban: city core areas characterized by extensive mid-and high-rise buildings, often with 100 percent lot coverage and limited surface parking⁹

The SDIA area is a heavily developed urban setting. Therefore, attention should be focused on the urban and dense urban settings.

The Caltrans suggested safety compatibility criteria for the five safety zones applicable to air carrier airports are listed in **Table E3-2**. Criteria for Urban and Dense Urban areas, which would apply in the area surrounding SDIA, are presented. Note that the Handbook recommends maximum intensities by safety zone based on the number of people per gross acre.¹⁰ Gross acreage describes the total area of a development project, before lots are platted and public rights-of-way, parks, and other public properties are dedicated. Because all property within the SDIA safety zones has been subdivided, most future development will occur on platted lots and would be more easily evaluated in terms of people per net acre. (Net acreage includes only the land actually available for development.) Thus, **Table E3-2** also expresses the Caltrans intensity and density guidance in terms of people and dwelling units per net acre.) The Handbook intensity limits were increased by 20 percent to convert them from intensity/density per gross acre to intensity/density per net acre.

⁹ California Department of Transportation, Division of Aeronautics, *California Airport Land Use Planning Handbook*, October 2011, p. 4-18.

¹⁰ California Department of Transportation, Division of Aeronautics, *California Airport Land Use Planning Handbook*, October 2011, pp. 4-20 – 4-24, 4-27.

Table E3-2 Safety Compatibility Criteria Guidelines per Caltrans Handbook

Maximum Residential Densities (Dwelling Units per Gross Acre)

	Safety Zone 1 Runway Protection Zone	Safety Zone 2 Inner Approach/Departure Zone	Safety Zone 3 Inner Turning Zone	Safety Zone 4 Outer Approach/Departure Zone	Safety Zone 5 Sideline Zone
Urban	0	0	Allow infill at up to average of surrounding residential area	Allow infill at up to average of surrounding residential area	Allow infill at up to average of surrounding residential area
Dense Urban	0	0	Allow infill at up to average of surrounding residential area	Allow infill at up to average of surrounding residential area	Allow infill at up to average of surrounding residential area

Maximum Nonresidential Intensities (People per Gross Acre)

	Safety Zone 1 Runway Protection Zone	Safety Zone 2 Inner Approach/Departure Zone	Safety Zone 3 Inner Turning Zone	Safety Zone 4 Outer Approach/Departure Zone	Safety Zone 5 Sideline Zone
Urban	0 *	60-80	100-150	150-200	100-150
Dense Urban	0 *	Allow infill at up to average intensity of comparable surrounding uses	Allow infill at up to average intensity of comparable surrounding uses	Allow infill at up to average intensity of comparable surrounding uses	Allow infill at up to average intensity of comparable surrounding uses

* Exceptions can be permitted for agricultural activities, roads, and automobile parking provided that FAA criteria are satisfied.

Source: Ricondo & Associates, Inc., March 2012, adapted from *California Airport Land Use Planning Handbook* Figures 4B through 4F, p. 4-20 through 4-24 (urban and dense urban maximum residential densities and nonresidential intensities).

Prepared by: Ricondo & Associates, Inc., May 2012.

E3.4 Technical Analysis

E3.4.1 Applicability of Caltrans Safety Zones at SDIA

Abbreviated terminology is used in this section to identify the safety zones. Safety Zone 1 on the west side of the Airport, for example, is referred to as SZ 1W. The northern part of Safety Zone 3 on the east side of the Airport is referred to as SZ 3NE. This labeling is reflected in the subsequent exhibits in this appendix.

Exhibit E3-3 depicts the standard Caltrans safety zones for air carrier runways as applied to SDIA. SZ 1E and SZ 1W have a somewhat different appearance than in the standard Caltrans example. Both RPZs at SDIA are set with respect to the displaced thresholds at each runway end. In addition, the Runway 27 RPZ (on the east side of the runway) is smaller than the RPZ in the Caltrans example because it is based on a nonprecision runway approach. (Refer to **Exhibit E3-1** for a detailed depiction of the RPZs at SDIA.) In addition, the outer boundary of SZ 1E is adjusted to reflect the portion of the OFZ that extends beyond the RPZ. The other safety zones are all tied to the actual runway ends, consistent with Handbook guidance. SZ 2E is larger than SZ 2W. This is because the displaced threshold on that side of the runway is much greater than on the west side, resulting in the greater displacement of the RPZ on the east than the west side. On each side of the Airport, SZ 2 actually extends the same distance from each runway end—6,200 feet.

E3.4.2 Safety Zone Adjustments to Reflect SDIA Operations

The Handbook suggests that the standard safety zones may be adjusted to “reflect characteristics of a specific airport runway.”¹¹ In assessing the specific characteristics of the use of the runway at SDIA, flight track data were collected and mapped on **Exhibit E3-3** with the Caltrans safety zones. Each flight track depicts the path of a single aircraft operation—either an approach or a departure. The data represent all operations recorded by the Airport’s Aircraft Noise and Operations Monitoring System (ANOMS) during a 12-month period ending May 31, 2011. During that period, 185,090 operations (takeoffs and landings) were recorded by the system. The top panel of the exhibit depicts arrival and departure tracks for jets and multi-engine propeller aircraft in a west flow operating configuration—with arrivals from the east to Runway 27 and departures to the west over the ocean on Runway 27. This configuration is used approximately 97 percent of the time. The bottom panel depicts flight tracks for an east flow configuration, with arrivals from the west to Runway 9 and departures to the east over the city on Runway 9. This configuration is used approximately 3 percent of the time.

¹¹ California Department of Transportation, Division of Aeronautics, *California Airport Land Use Planning Handbook*, October 2011, Table 3A “Safety Adjustment Factors”, p. 3-22.

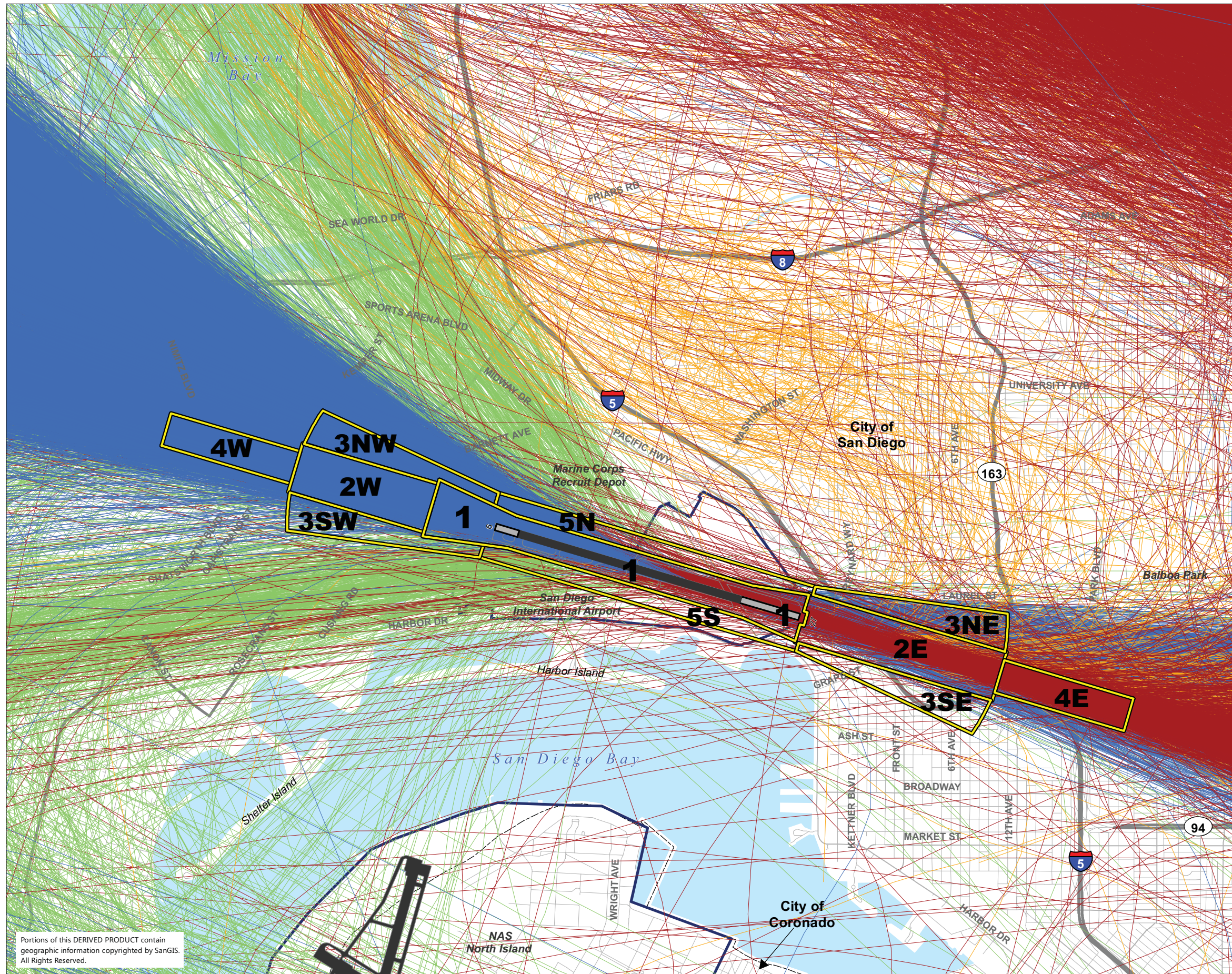

LEGEND

- Major Roads
- Highways
- - - Municipal Boundaries
- ▬ Displaced Thresholds
- ▬ Airport Property Boundary
- ▬ Standard Caltrans Safety Zone Boundaries
- Jet Arrivals
- Jet Departures
- Multi-Engine Propeller Arrivals
- Multi-Engine Propeller Departures

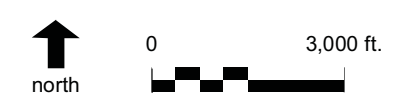

Sources: San Diego Geographic Information Source (SanGIS), 2008 and 2011 (municipal boundaries, roads and highways); Ricondo & Associates, Inc., January 2012, based on GIS datasets received from the City of San Diego, SanGIS and San Diego Association of Governments (SANDAG) (GIS datasets were updated based on surveys conducted in July and November 2011; safety compatibility zones).

Prepared by: Ricondo & Associates, Inc., March 2012.

Exhibit E3-3
Caltrans Safety Zones Applied to SDIA and Radar Flight Tracks

Portions of this DERIVED PRODUCT contain geographic information copyrighted by SanGIS. All Rights Reserved.

Exhibit E3-3 also depicts the generalized instrument arrival and departure courses with green and red arrows. The green arrows represent generalized instrument approach courses aligned with Runway 9-27. Note how, within two to three miles from both runway ends, the great majority of arrival flight tracks are clustered along a pathway aligned with the runway centerline, forming a distinct arrival corridor. Red arrows represent standard instrument departure courses. As depicted on **Exhibit E3-3**, these arrows represent the generalized pathways that aircraft follow when climbing towards the published Standard Instrument Departure (SID) checkpoints, following the 275 degree and 290 degree headings. As depicted, the vast majority of jet departure flight tracks are heavily concentrated in limited areas on each side of the Airport. On the west side, jet departures are concentrated between the 275 degree and 290 degree headings. The slower propeller aircraft departures, as depicted in green, are often assigned other routes and headings by air traffic control to safely separate them from the faster jets. Departures toward the 250 degree (toward the southwest) and 310 degree (toward the northwest) headings often assigned by air traffic control are clearly depicted by the green multi-engine propeller departure flight tracks.¹²

Based on guidance contained in Table 3A of the Handbook "*Safety Zone Adjustment Factors - Airport Operational Variables*", safety zone boundaries may be adjusted to "take into account various operational characteristics of a particular airport runway."¹³

Except for a few areas discussed in this section, and as depicted on **Exhibit E3-3**, the Caltrans safety zones provide adequate coverage for the areas subject to frequent close-in arrival and departure activity. Specifically, the standard configurations of SZ 3NW and SZ 4W, as depicted on **Exhibit E3-3**, do not cover the dense concentration of departures following the 290 degree heading.

Exhibit E3-4 depicts the standard Caltrans safety zones with two different representations of the flight track data on the west side of the Airport. The top panel depicts the actual radar departure tracks, while the bottom panel portrays the safety zones on a map of flight track densities.¹⁴ The demarcation of the two flight corridors associated with the 275 degree and 290 degree headings is quite apparent in the flight track density map.

As depicted in **Exhibit E3-5**, adjustments in SZ 3W North and SZ 4W are made to provide coverage beneath the 290 degree corridor as well as the 275 degree corridor. SZ 3W North is extended or "fanned" further to the north. Its northern corner is set at the same distance from the nominal centerline of the 290 degree corridor as it would be from the extended runway centerline using the standard Caltrans configuration for SZ3 (1,879 feet). SZ 4W is fanned to the north, with the northern boundary set the same distance from the centerline of the 290 degree corridor as it would be from the extended runway centerline using the standard Caltrans configuration for SZ4 (500 feet).

¹² Currently, propeller aircraft account for approximately 12 percent of all operations. That share is forecasted to decline to 4 percent by 2030.

¹³ California Department of Transportation, Division of Aeronautics, *California Airport Land Use Planning Handbook*, October 2011, Table 3A "*Safety Adjustment Factors*", p. 3-22.

¹⁴ The flight track density exhibits indicate the number of average daily overflights in any given area. The area is defined by a grid of cells 33 meters square (.27 acres).

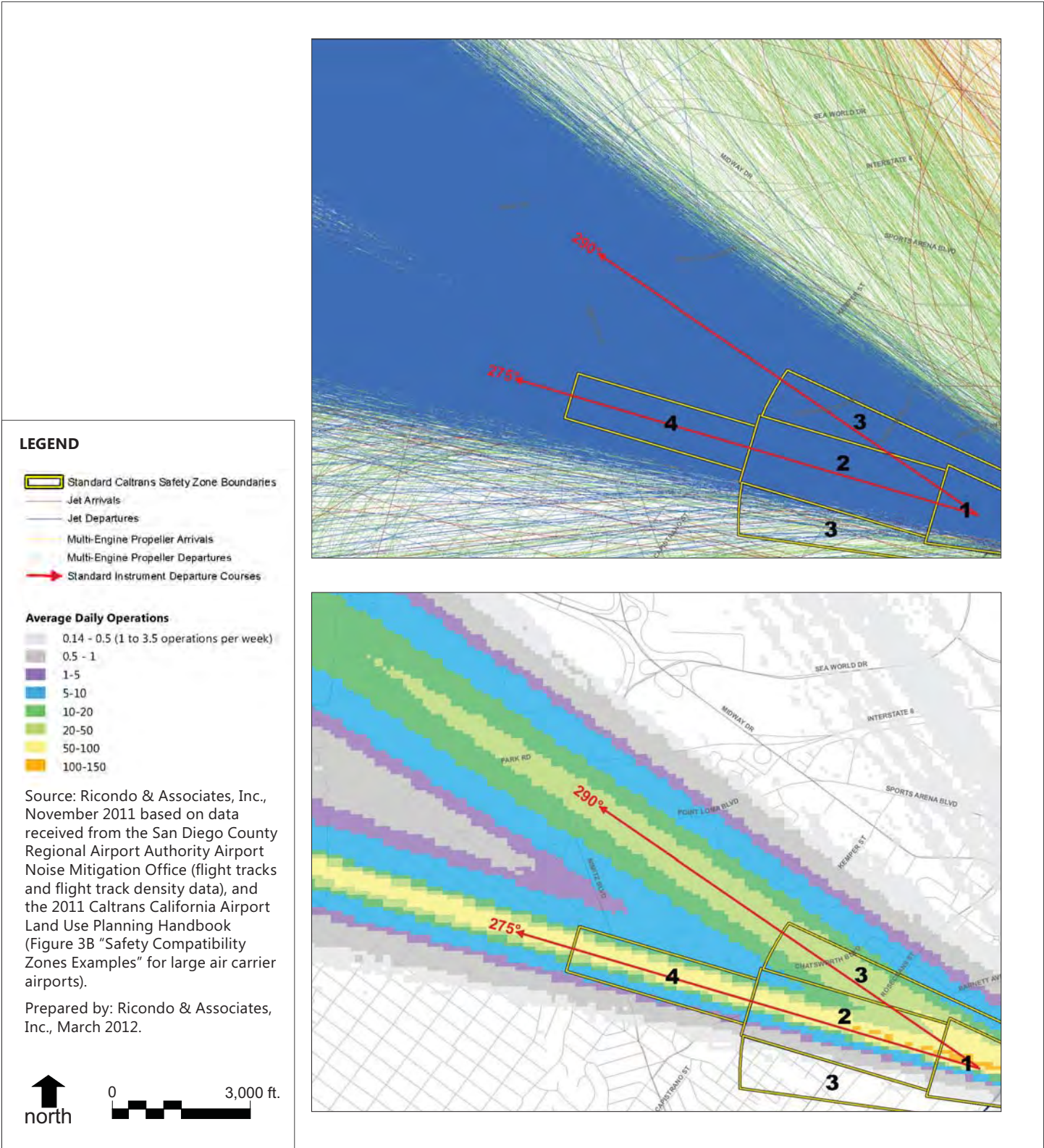
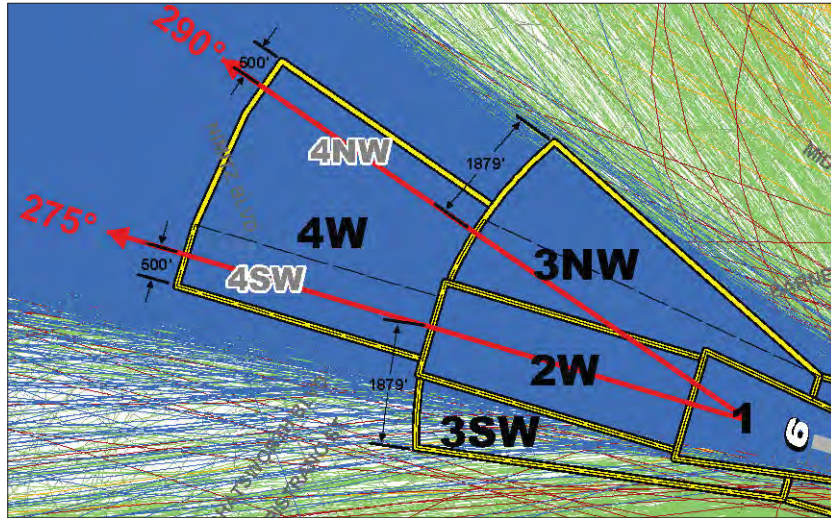

Exhibit E3-4

Area Along 290° Heading Corridor
Not Covered by Standard Safety Zones





LEGEND

- Proposed Safety Zones
- Standard Caltrans Safety Zone Boundaries
- Jet Arrivals
- Jet Departures
- Multi-Engine Propeller Arrivals
- Multi-Engine Propeller Departures
- Instrument Approach Courses
- Standard Instrument Departure Courses

Notes:

Flight tracks represent all aircraft operations on Runway 9-27 from June 1, 2010 through May 31, 2011, during which a total of 185,090 operations were recorded.

Source: Ricondo & Associates, Inc., November 2011 based on data received from the San Diego County Regional Airport Authority Airport Noise Mitigation Office (flight track data), and the 2011 Caltrans California Airport Land Use Planning Handbook (Figure 3B "Safety Compatibility Zones Examples" for large air carrier airports).

Prepared by: Ricondo & Associates, Inc., March 2012.



Exhibit E3-5

Adjustments to Safety Zones 3 and 4 – Westside

Based on the adjustments described above, **Exhibit E3-6** depicts the proposed safety zones at SDIA. **Exhibit E3-7** depicts the safety zone dimensions in comparison with the standard Caltrans safety zones.

E3.4.3 Adjustments to Safety Zone 1 Post Release of July 2013 Draft ALUCP

As discussed in Appendix E.1, after the release of the July 2013 Draft ALUCP, on November 7, 2013, the FAA issued a Finding of No Significant Impact (FONSI) for the Runway 9 Displaced Threshold Environmental Assessment related to the relocation of the Runway 9 displaced threshold 300 feet to the east.

As depicted on Exhibit E3-1, and because of the additional 300-foot displacement of the Runway 9 threshold compared to existing conditions, the Runway 9 RPZ (i.e., SZ 1) shifted 300 feet to the east compared with its location depicted on the October 2012 ALP. Accordingly, Exhibits E3-6 and E3-7, and a new Exhibit E3-10, were updated to reflect the shifted location of SZ 1.

E3.5 Safety Compatibility Policy Considerations

Nearly all land in the SDIA vicinity, including the land within the safety zones, has been fully developed for many years. In fact, the greatest influence on the future development pattern is the nature and character of existing development. A combination of real estate market forces, the interests of current property owners and residents, and local agency policies and regulations will also influence the preservation or redevelopment of areas surrounding the Airport.

This section presents proposed safety compatibility goals and objectives for this ALUCP. Existing land use in the proposed safety zones is also described in this section, followed by a discussion of the land use designations from the applicable Community Plans.

E3.5.1 Proposed Safety Compatibility Goal and Objectives

The following goal and objectives are the foundation of the safety compatibility policies and standards at SDIA.

Goal: Minimize the consequences of aircraft accidents and emergency landings to people and property on the ground.

Objectives:

- Avoid increasing the degree of incompatible development within the proposed safety zones for SDIA.
- As redevelopment occurs within the proposed safety zones, avoid increasing residential densities and non-residential development intensities above the current levels.
- Avoid the future development of new land uses which the Handbook advises to be

prohibited within the safety zones.

- Ensure that new highly risk-sensitive land uses and those serving and housing vulnerable occupants are avoided in the proposed safety zones.
- Ensure that safety compatibility policies and standards are sensitive to the long-term sustainability and viability of the existing neighborhoods and business districts within the proposed safety zones, to the extent consistent with the preceding objectives.

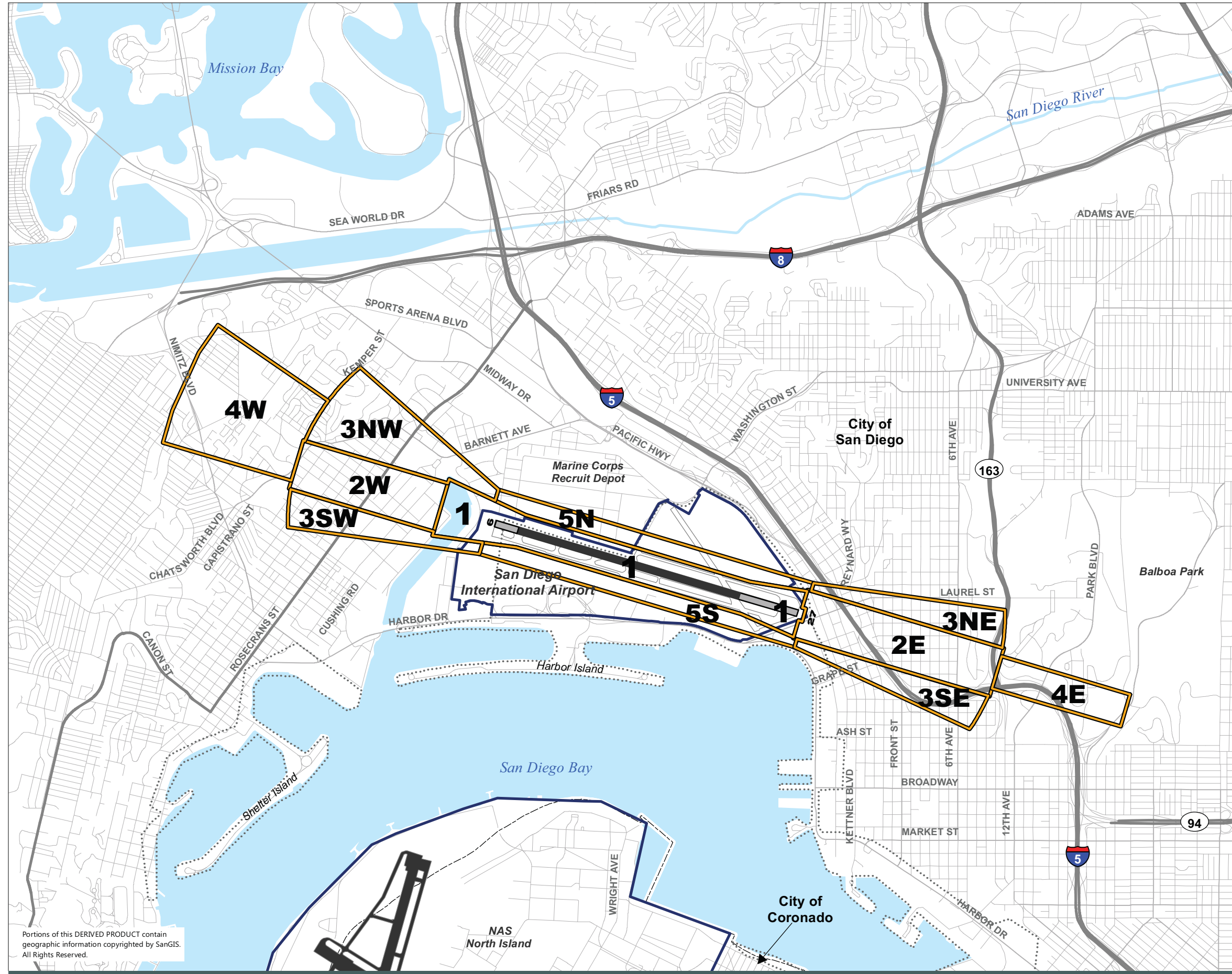

LEGEND

- Major Roads
- Highways
- Municipal Boundaries
- Displaced Thresholds
- Airport Property Boundary
- Proposed Safety Compatibility Zone
- San Diego Unified Port District Planning Jurisdiction Boundary

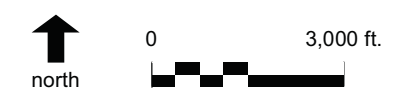

Note: The outer boundary of the Safety Zone 1 East (Runway 27 Ruway Protection Zone (RPZ)) is adjusted to reflect the portion of the Runway Obstacle Free Zone (OFZ) that extends beyond the RPZ.

Sources: San Diego Geographic Information Source (SanGIS), 2008 and 2011 (municipal boundaries, roads and highways); Ricondo & Associates, Inc., January 2012, based on GIS datasets received from the City of San Diego, SanGIS and San Diego Association of Governments (SANDAG) (GIS datasets were updated based on surveys conducted in July and November 2011; safety compatibility zones).

Prepared by: Ricondo & Associates, Inc., December 2013.

Exhibit E3-6 Proposed Safety Compatibility Zones

Portions of this DERIVED PRODUCT contain geographic information copyrighted by SanGIS. All Rights Reserved.

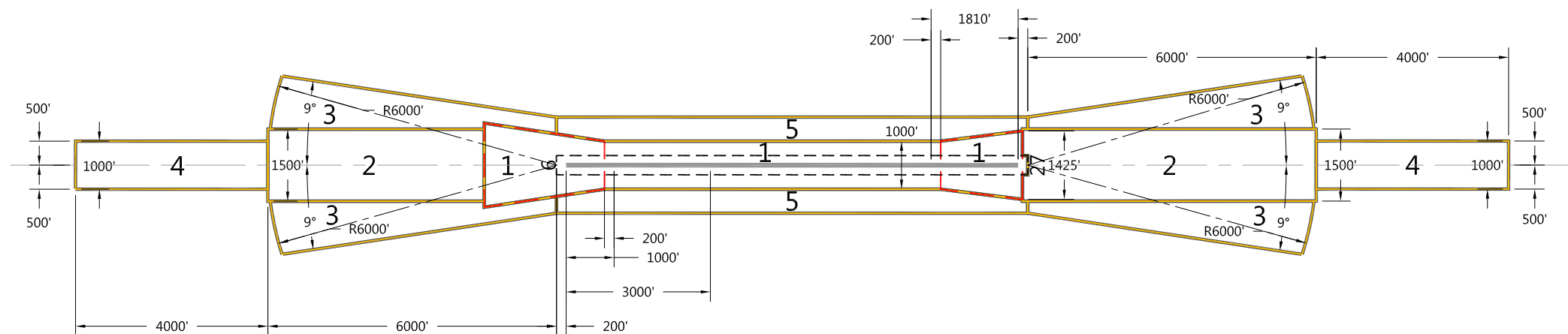

LEGEND

- Runway 9-27
- - - Extended Imaginary Runway Centerline
- Safety Zone
- Runway Protection Zone (RPZ)
- - - Runway Obstacle Free Zone (OFZ)



0 3,000 ft.

Caltrans Safety Zones Applied to SDIA

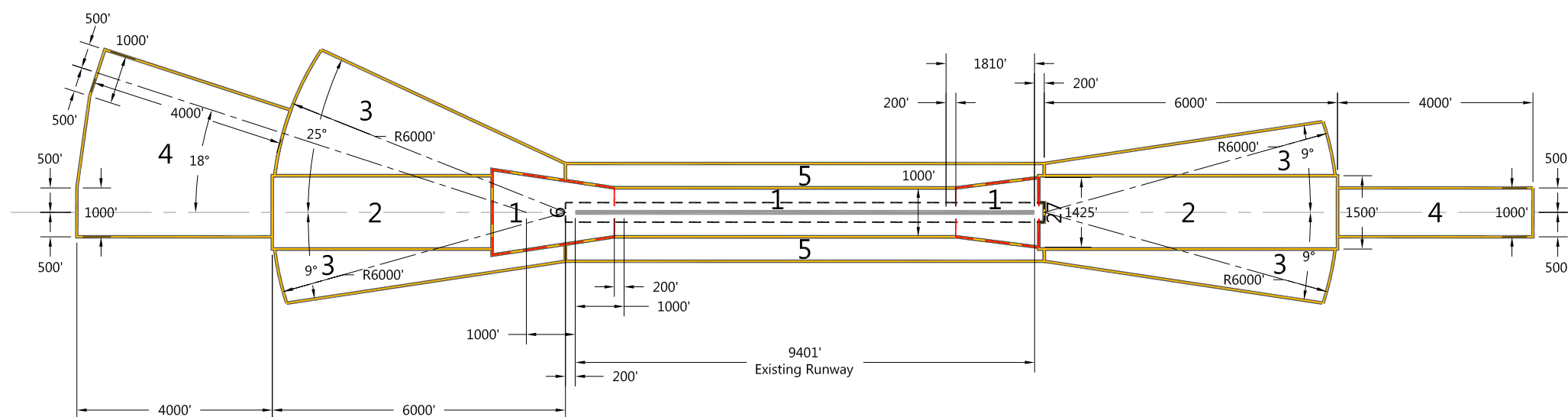

0 3,000 ft.

Proposed Safety Zones

Note:

1. The outer boundary of Safety Zone 1 East (Runway 27 RPZ) is adjusted to reflect the portion of the OFZ that extends beyond the RPZ.

Sources: Ricondo & Associates, Inc. November 2011, based on San Diego County Regional Airport Authority, Airport Layout Plan, July 10, 2009 (runway protection zones and runway obstacle free zone); and proposed safety zone layout and dimensions. Prepared by: Ricondo & Associates, Inc., December 2013.

**Exhibit E3-7
Comparison of Caltrans
Safety Zones and Proposed Safety
Zones Layout and Dimensions**

E3.5.2 Existing Land Use and General Plan Land Use Designations

Exhibit E3-8 depicts existing land use within the proposed safety zones (top panel) and General Plan land use designations (bottom panel) on the east side of the Airport. The proposed safety zones located east of SDIA encompass parts of Balboa Park and the Midway-Pacific Highway, Uptown, and Centre City Community Planning Areas (CPA). Parts of the Little Italy, Cortez, and East Village neighborhoods in Centre City are also within the area. The development pattern in these areas is greatly diversified and mixed. Land uses include multi-family residential, industrial, hospital and healthcare facilities, commercial, transportation, schools and institutional uses. To the east of 6th Avenue, Balboa Park occupies large parts of SZ 2E, SZ 3NE and SZ 4E. North and east of Interstate 5, the majority of the land uses are multi-family residential, commercial and office. The area located south and west of Interstate 5 includes mainly industrial, commercial and office land uses, with some multi-family residential. Four schools are located within the proposed safety zones, namely Washington Elementary School (SZ 3SE), California Western School of Law (SZ 3SE), Balboa City School (SZ 2E) and San Diego Senior High School (SZ 4E).

The General Plan land use designations, depicted on the bottom panel of **Exhibit E3-8**, indicate the land uses that are acceptable for new development or redevelopment. Those uses are generally similar to the existing land uses presented in the top panel of the exhibit. The General Plan land use designations include mixed-use, medium- and high-intensity residential, industrial, commercial, institutional services and open space uses. East of 6th Avenue, open space and institutional services uses encompass the vast majority of the area located within the proposed SZ 2E, SZ 3NE and SZ 4E. North and east of Interstate 5, mixed-use and medium-intensity residential uses encompass the majority of the area within SZ 2E and SZ 3NE, with a few areas dedicated to industrial and commercial uses.

The top panel of **Exhibit E3-9** depicts existing land use on the west side of the airport. Parts of the Midway-Pacific Highway and Peninsula CPAs are within the proposed safety zones west of the Airport. Low-density residential (single-family) is the predominant land use; with a few pockets of commercial land uses, some scattered higher density residential areas, and a few schools and places of worship. A large mixed-use development occupies the area formerly known as the Naval Training Center (NTC). The northeast half of NTC is within the proposed safety zones. Land uses in this area include office, commercial, institutional, industrial, park and recreation. West of Rosecrans Street and within proposed SZ 2W and SZ 3NW and SZ 3 SW, the great majority of land uses are single-family residential. Within proposed SZ 4W, three major land uses are present: single-family and multi-family residential, as well as open space, park and recreation. Proposed SZ 4W encompasses some commercial development along Voltaire Street. Five schools are located within the proposed safety zones, namely Point Loma High School (SZ 2W, 3SW and 4W), Loma Portal Elementary School (SZ 2W), Loma Portal Charter School (SZ 3NW) St. Charles Borromeo Academy (SZ 3NW), and Correia Middle School (SZ 4W).

The bottom panel of **Exhibit E3-9** depicts the General Plan land use designations on the west side of the Airport. In the Point Loma area, low- and medium-density residential uses are the predominant existing community plan land use designations located within the proposed SZ 2W, SZ 3NW, SZ 3SW and SZ 4W. The NTC area is designated for mixed-use. A few areas are shown as dedicated to open space and commercial development within SZ 3NW, SZ 3SW and SZ 4W.

As discussed in Section E3.4.3, **Exhibit E3-10** depicts the proposed safety compatibility zones reflecting the revised location of SZ 1 based on the ultimate Runway 9 displaced threshold and associated RPZ.

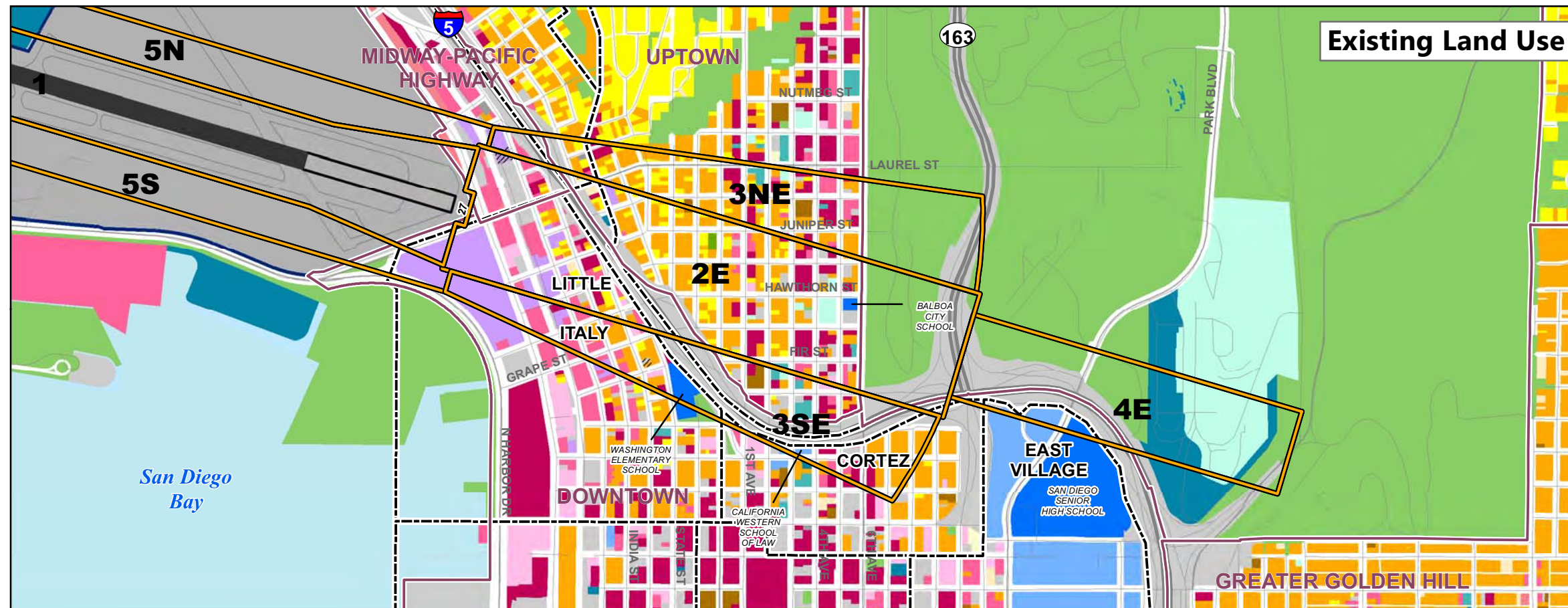

LEGEND

- Major Roads
 - Highways
 - ▭ Airport Property Boundary
 - ▭ Community Planning Areas
 - ▭ Proposed Safety Compatibility Zone
 - ▭ Neighborhood Boundaries
- | Existing Land Use | General Plan Land Use |
|---|------------------------------|
| Residential - Single Family | Residential |
| Residential - Multi-Family | Commercial |
| Group Quarters | Industrial |
| Commercial - Guest | Mixed Use |
| Lodging | Institutional - Services |
| Commercial | Institutional - Utilities |
| Office | Institutional - Military Use |
| Industrial | School |
| Hospital and Healthcare Facilities | Open Space |
| Institutional - Assembly | Transportation |
| Institutional - Other | Water |
| School (K-12), Children's Day Care Center | Planned Development |
| University/College/Trade School | |
| Open Space, Parks, Recreation | |
| Agriculture | |
| Transportation | |
| Utilities | |
| Other - Under Construction | |
| Vacant | |
| Water | |

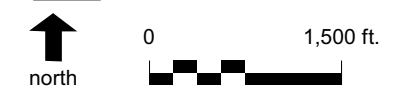

Sources: San Diego Geographic Information Source (SanGIS) updated in 2011 (roads and highways); City of San Diego, August 2011 (neighborhood boundaries); Ricondo & Associates, Inc., February 2011, based on information received from the City of San Diego Development Services Planning Division (general plan land use designation GIS data for Peninsula, Midway-Pacific Highway, Old Town San Diego, Uptown, Centre City and Greater Golden Hill community planning areas).

Prepared by: Ricondo & Associates, Inc., March 2012.

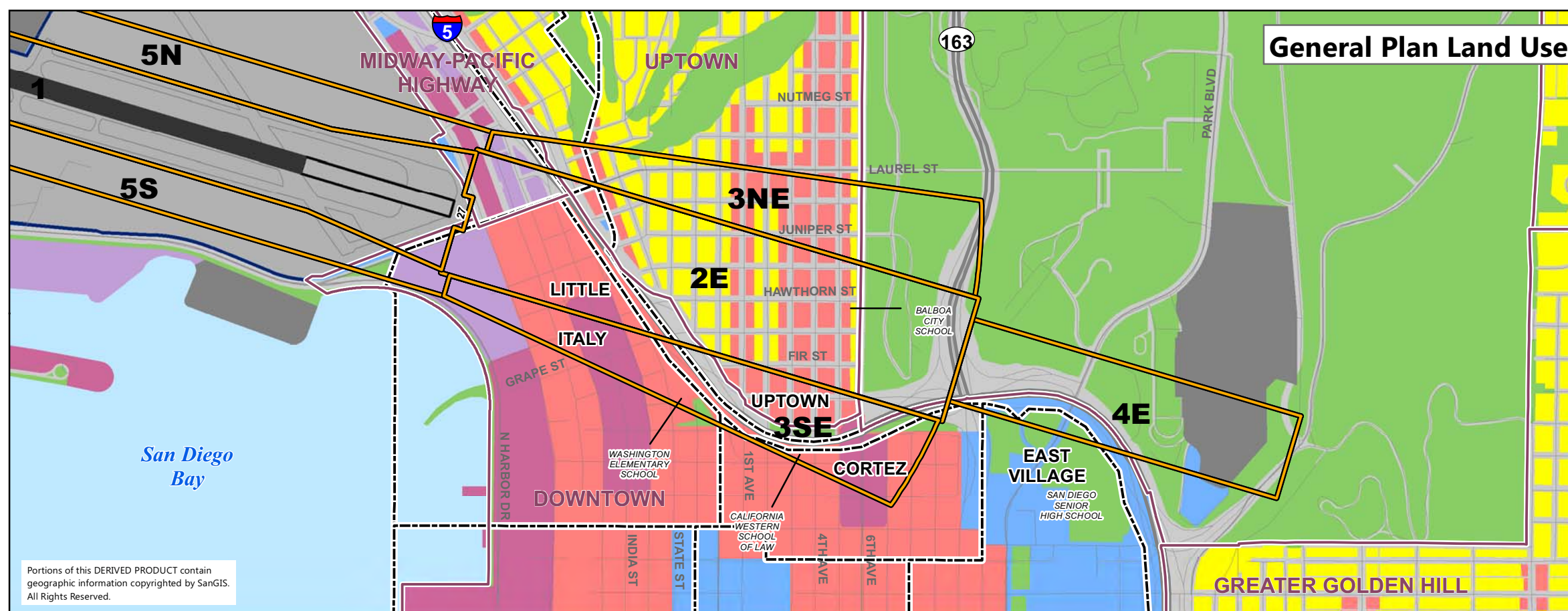

Portions of this DERIVED PRODUCT contain geographic information copyrighted by SanGIS. All Rights Reserved.

**Exhibit E3-8
Proposed Safety Compatibility Zones,
Existing and General/Community
Plan Land Uses – Eastside**

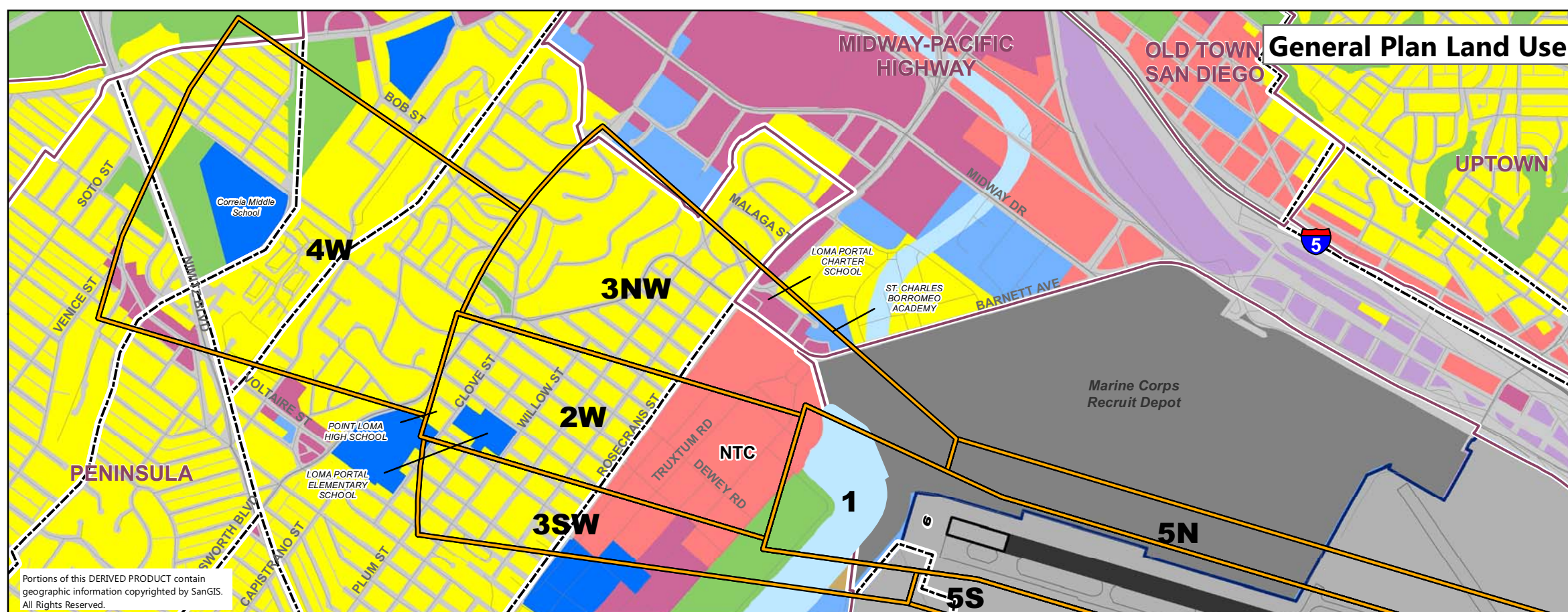
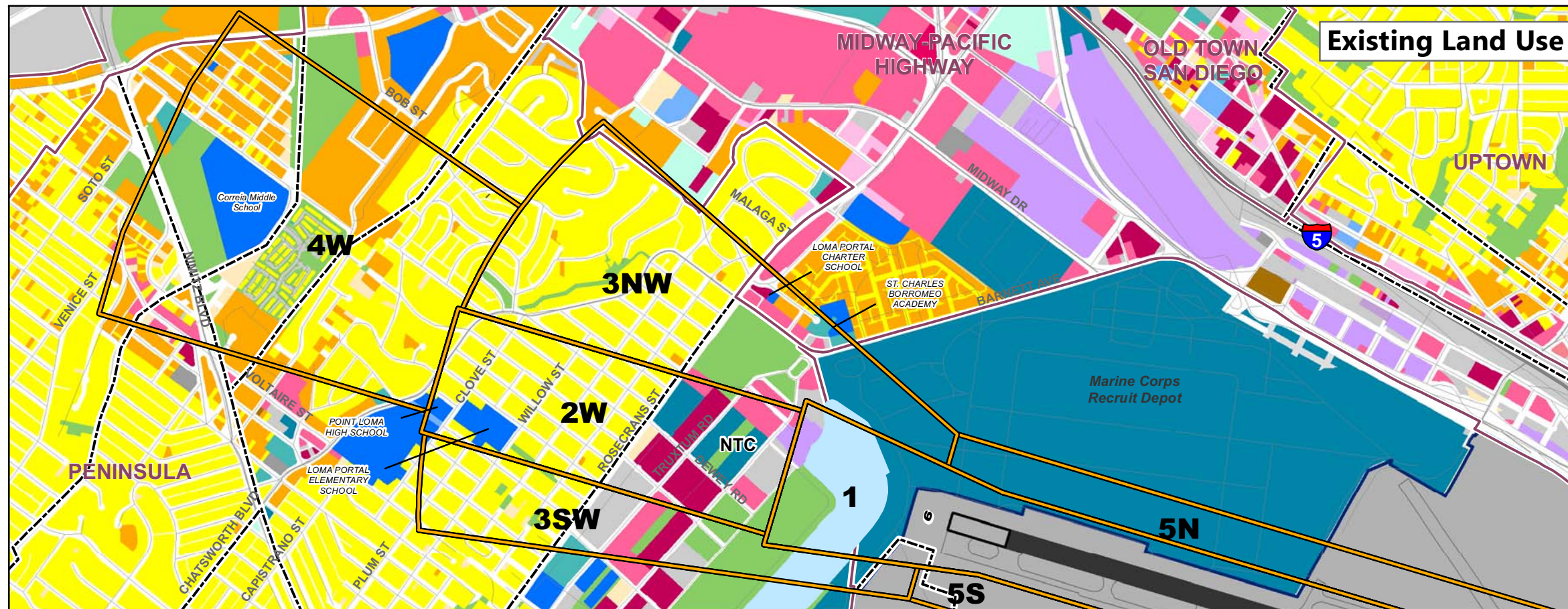

LEGEND

- Major Roads
 - Highways
 - ▭ Airport Property Boundary
 - ▭ Community Planning Areas
 - ▭ Proposed Safety Compatibility Zone
 - ▭ Neighborhood Boundaries
- | Existing Land Use | General Plan Land Use |
|---|------------------------------|
| Residential - Single Family | Residential |
| Residential - Multi-Family | Commercial |
| Group Quarters | Industrial |
| Commercial - Guest | Mixed Use |
| Lodging | Institutional - Services |
| Commercial | Institutional - Utilities |
| Office | Institutional - Military Use |
| Industrial | School |
| Hospital and Healthcare Facilities | Open Space |
| Institutional - Assembly | Transportation |
| Institutional - Other | Water |
| School (K-12), Children's Day Care Center | Planned Development |
| University/College/Trade School | |
| Open Space, Parks, Recreation | |
| Agriculture | |
| Transportation | |
| Utilities | |
| Other - Under Construction | |
| Vacant | |
| Water | |



Sources: San Diego Geographic Information Source (SanGIS) updated in 2011 (roads and highways); City of San Diego, August 2011 (neighborhood boundaries); Ricondo & Associates, Inc., February 2011, based on information received from the City of San Diego Development Services Planning Division (general plan land use designation GIS data for Peninsula, Midway-Pacific Highway, Old Town San Diego, Uptown, Centre City and Greater Golden Hill community planning areas).

Prepared by: Ricondo & Associates, Inc., March 2012.

Exhibit E3-9
Proposed Safety Compatibility Zones,
Existing and General/Community
Plan Land Uses – Westside

Portions of this DERIVED PRODUCT contain geographic information copyrighted by SanGIS. All Rights Reserved.

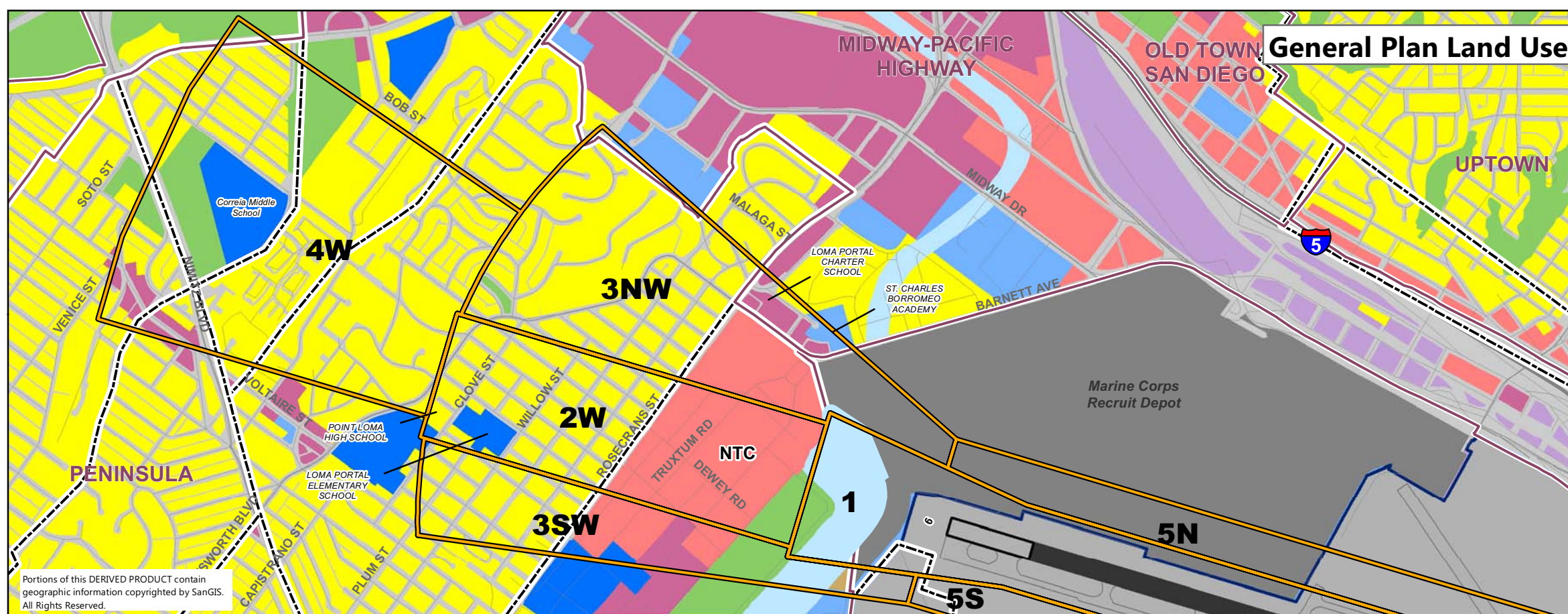
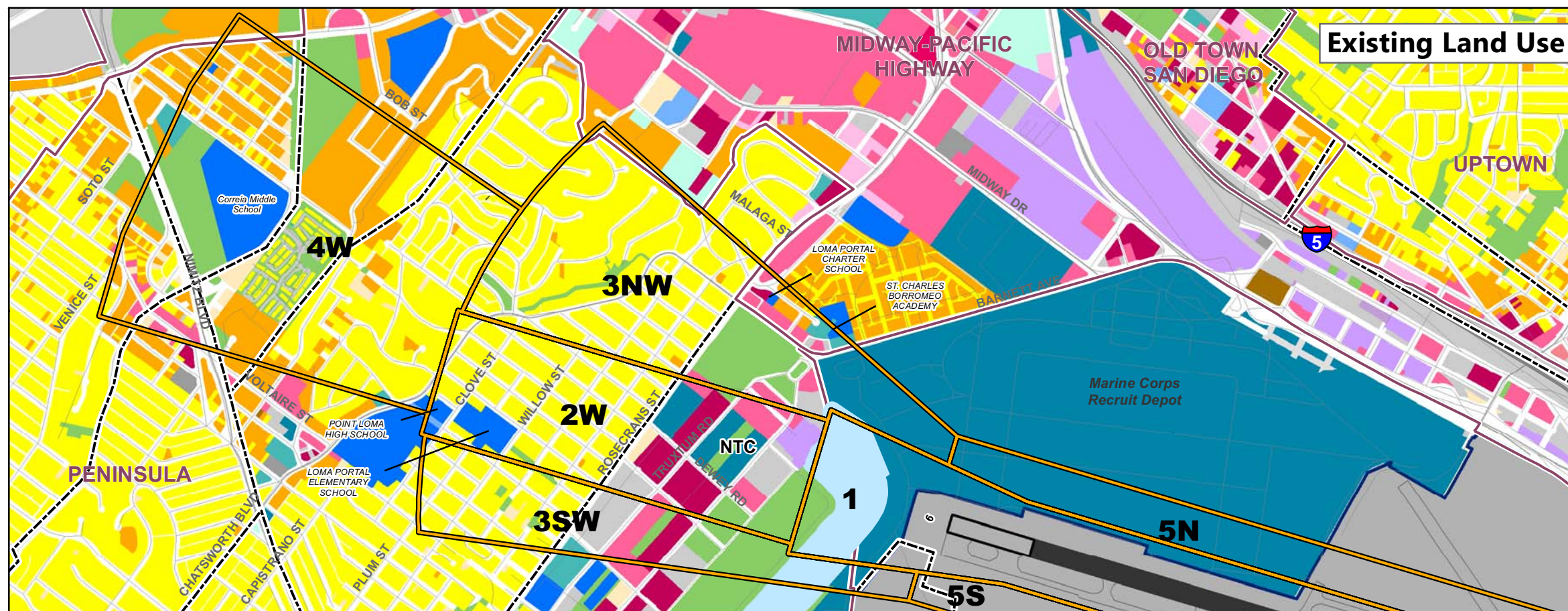

LEGEND

- Major Roads
 - Highways
 - ▭ Airport Property Boundary
 - ▭ Community Planning Areas
 - ▭ Proposed Safety Compatibility Zone
 - ▭ Neighborhood Boundaries
- | | |
|---|------------------------------|
| Existing Land Use | General Plan Land Use |
| Residential - Single Family | Residential |
| Residential - Multi-Family | Commercial |
| Group Quarters | Industrial |
| Commercial - Guest | Mixed Use |
| Lodging | Institutional - Services |
| Commercial | Institutional - Utilities |
| Office | Institutional - Military Use |
| Industrial | School |
| Hospital and Healthcare Facilities | Open Space |
| Institutional - Assembly | Transportation |
| Institutional - Other | Water |
| School (K-12), Children's Day Care Center | Planned Development |
| University/College/Trade School | |
| Open Space, Parks, Recreation | |
| Agriculture | |
| Transportation | |
| Utilities | |
| Other - Under Construction | |
| Vacant | |
| Water | |



Sources: San Diego Geographic Information Source (SanGIS) updated in 2011 (roads and highways); City of San Diego, August 2011 (neighborhood boundaries); Ricondo & Associates, Inc., February 2011, based on information received from the City of San Diego Development Services Planning Division (general plan land use designation GIS data for Peninsula, Midway-Pacific Highway, Old Town San Diego, Uptown, Centre City and Greater Golden Hill community planning areas).

Prepared by: Ricondo & Associates, Inc., December 2013.

Exhibit E3-10
Updated Safety Compatibility Zones,
Existing and General/Community
Plan Land Uses – Westside

Portions of this DERIVED PRODUCT contain geographic information copyrighted by SanGIS. All Rights Reserved.



E3.5.3 Scope of Safety Policies and Standards

Based on the guidance provided in the 2011 Handbook, land use policies and standards related to safety should recognize the potential severity of consequences of aircraft accidents while recognizing the potential probability of accidents in areas near the airport. The Handbook advises a policy framework that would prohibit highly sensitive land uses in the safety zones and limit the density of housing and the intensity of occupancy in nonresidential land uses. In applying this guidance, the land use restrictions would be stricter in the safety zones with higher accident risks.¹⁵

The Handbook also acknowledges that safety compatibility policies and standards in urbanized areas must recognize the existing development pattern in the airport vicinity. In urbanized areas, ALUCP policies must acknowledge that some redevelopment is likely in the future. At the same time, the ALUCP should incorporate realistic limits on the density and intensity of redevelopment to ensure that the existing land use incompatibilities are not increased.

In this ALUCP, the Handbook guidance has been applied by assigning land uses into three compatibility categories:

- *Compatible* land uses are consistent with the ALUCP
- *Conditionally compatible* land uses are consistent only if applicable conditions are met
- *Incompatible* land uses are inconsistent with the ALUCP

E3.5.3.1 Compatible Uses

Compatible land uses are consistent with the safety policies and standards of this ALUCP.

E3.5.3.2 Conditionally Compatible Uses

Conditionally compatible uses are those that can be made compatible within the safety zones if they are developed in compliance with certain conditions. The conditions of broadest applicability are limits on residential density and on the occupancy level of nonresidential uses, expressed as “intensity” (the number of people per acre).

In urban and dense urban areas, the Handbook advises that new dwellings should be allowed in SZ3, 4 and 5 only up to the average density of the surrounding residential area. The Handbook also advises that no new residential development be allowed within SZ2. In the area surrounding SDIA, large proportions of SZ2 on both sides of the Airport are developed with existing residential use. An outright prohibition of new residential development in these areas could set the stage for disinvestment in these neighborhoods and the onset of blight. For that reason, the approach recommended in the Handbook for SZ3, 4, and 5 was also applied to SZ2 in the area surrounding SDIA.

¹⁵ California Department of Transportation, Division of Aeronautics, *California Airport Land Use Planning Handbook*, October 2011, pp. 4-17 – 4-34.

For nonresidential land uses, the Handbook offers different guidance for “urban” areas compared to “dense urban” areas. In urban areas, the Handbook advises maximum nonresidential intensities ranging from 60 to 200 people per acre, depending on the safety zone. (Refer to **Table E3-2** for details.) In dense urban areas, the Handbook advises that new nonresidential development should not exceed the average intensity of comparable surrounding uses.

Standards for Conditionally Compatible Residential Uses

In the safety zones where residential uses are conditionally compatible, the maximum allowable residential densities are set in conformance with the guidance in the Caltrans Handbook – allow new residential development “up to the average of the surrounding residential area.” Because the Handbook guidance is general, it is necessary to develop a specific methodology for applying the guidance. For purposes of this ALUCP, the “surrounding residential area” is considered as each part of a CPA or officially designated neighborhood within a CPA within each safety zone. Within each of these areas, a detailed land use inventory was undertaken. The actual densities of all residential lots were calculated and summary statistics for each area were produced.

In setting the maximum allowable residential density in each CPA/safety zone (with the exception of SZ 3SE), the “average” density is taken as 110 percent of the calculated average density in the CPA/safety zone. This was done in recognition of the substantial variation in the actual densities in each CPA/safety zone. It also recognized the infill policy of the previous ALUCP, where new development was allowed at up to 110 percent of the average intensity of uses within a radius of 0.25 miles of the subject site.

Extensive analysis was prepared to assess the unique characteristics of SZ 3SE. This safety zone covers a densely developed area encompassing sections of three distinct neighborhoods. Due to published flight procedures at SDIA, low overflight activity in this area makes SZ 3SE unique when compared to other safety zones. Based on extensive coordination with the Steering Committee, the City of San Diego and Civic San Diego (formerly known as Centre City Development Corporation (CCDC)), the maximum allowable residential density in SZ 3SE is set at two times the calculated average of existing density in each CPA/neighborhood in the safety zone.

While the maximum allowable residential densities vary by CPA and safety zone due to the existing character of each area, the overall density of future development in the affected areas will be generally consistent with the current densities.

Standards for Conditionally Compatible Nonresidential Uses

In the safety zones where nonresidential uses are conditionally compatible, the maximum allowable intensities are set in conformance with the Handbook guidance for urban and dense

urban areas.¹⁶ The actual intensities for all lots in each part of the CPA/neighborhood within each safety zone were calculated based on the detailed land use inventory developed for the area. Summary statistics were produced for each CPA (or neighborhood) by safety zone.

For all safety zones, except SZ 3SE, the maximum allowable intensities are based on the higher of:

- the maximum intensity levels for urban areas suggested in the 2011 *Handbook*, or
- 110 percent of the calculated average nonresidential intensities in the portions of each CPA within each safety zone.¹⁷

For the same reasons mentioned above, maximum allowable intensity in SZ 3SE is set at two times the calculated average of existing intensity in each CPA/neighborhood in the safety zone.

As with the residential densities, the maximum allowable intensities vary by CPA and safety zone due to the existing character of each area, therefore the allowable intensities of future development in the affected areas will be generally consistent with the current intensities.

Table 3-1 in **Chapter 3** of this ALUCP provides maximum allowable intensities for each nonresidential land use that is conditionally compatible in the safety zones. The occupancy factors, which are used to calculate the intensity of proposed conditionally compatible uses, were derived from the adopted Urban ALUCPs and the California Building Code (CBC). When CBC factors were used, they were adjusted in accordance with guidance from the Caltrans Handbook, Appendix G. The Handbook advises that CBC factors, which are indicators of maximum building occupancy, should be reduced by 50 percent when used to estimate intensity for ALUCPs. The maximum intensity levels in ALUCPs are intended to reflect typical occupancy levels rather than theoretical maximum levels.

Mixed residential-nonresidential development projects are common in San Diego, especially in and near downtown. In accounting for these kinds of development project, the safety standards require that the total intensity of the mixed use project must not exceed the maximum allowable intensity provided for in **Table 3-1** in **Chapter 3**. This policy requires the calculation of the “intensity” of the residential component of these mixed-use projects. This requires the conversion of the housing density to an estimated number of housing occupants – the residential intensity. This is accomplished by multiplying the number of housing units by

¹⁶ In dense urban areas, the Handbook guidance advises setting intensity limits based on the average intensity of comparable surrounding uses. In applying this guidance, “comparable surrounding uses” were considered to be all conditionally allowable nonresidential uses within the portion of the CPA (or neighborhood) within each safety zone. “Average” intensity was taken as 110 percent of the calculated mean intensity of the conditionally allowable existing nonresidential uses. This recognized the wide variation in the actual intensities in each CPA/safety zone. It also recognized the infill policy of the previous ALUCP, where new development was allowed at up to 110 percent of the average intensity of uses within a radius of 0.25 miles of the subject site.

¹⁷ Average nonresidential intensities were calculated for all existing nonresidential land uses that would be conditionally allowed in any of the Safety Zones. Uses classified as “incompatible” were not considered. The occupancy factors presented in Table 3-1 in Chapter 3 were applied to each existing land use to calculate intensity.

an average population per household factor. **Table E3-3** presents the average population per household factors for each safety zone.

Table E3-3 Household Population in Proposed Safety Zones

	Eastside Safety Zone				Westside Safety Zones				Total
	2E	3NE	3SE	4E	2W	3NW	3SW	4W	
Household Population	2,346	1,656	1,934	0	798	961	402	5185	13,282
Total Housing Units	1,558	1,116	1,228	0	340	424	180	2,421	7,267
Average Persons per Household	1.51	1.48	1.57	1.52 ^{1/}	2.35	2.27	2.23	2.14	1.83

NOTE: 1/ The custom report did not report any household population or housing units within Safety Zone 4E. An average persons per household factor for the eastside safety zones was calculated (1.52) and applied to Safety Zone 4E.

Source: SANDAG, October 2012 (custom report prepared for San Diego County Regional Airport Authority).
Prepared by: Ricondo & Associates, Inc., June 2013.

E3.5.3.3 Incompatible Uses

As summarized in **Table E3-2**, the Handbook advises the prohibition of certain land uses in the safety zones. In Safety Zone 1, any structures are to be considered incompatible and should be prohibited. In the other safety zones, only selected land uses are to be considered incompatible.

In this ALUCP, several land uses of special concern are considered incompatible uses in the safety zones. These include uses serving vulnerable populations, uses involving hazardous materials, and critical public utilities.

Uses Serving Vulnerable Occupants

In this ALUCP, "vulnerable occupants" are people with reduced effective mobility. They are subject to relatively greater risks of harm in the event of an aircraft accident than fully ambulatory people. People with reduced effective mobility include the disabled, bedridden and people needing supervision to respond to emergencies and safely evacuate buildings (including, for example, children, the elderly and prisoners). Examples of uses in this category are:

- Children's schools (grades Pre-K-12)
- Assembly - Children
- Day care centers

- Hospitals and convalescent and nursing homes
- Jails and prisons, including other public inmate facilities

Uses Involving Hazardous Materials

Facilities involving the manufacture, processing, or storage of large quantities of highly flammable, explosive, corrosive, or toxic materials can pose serious risk to the public in case of aircraft accidents. Examples are:

- Facilities such as oil refineries and chemical plants that process and store bulk quantities (tank capacities greater than 10,000 gallons) of highly hazardous materials
- Facilities where hazardous materials are stored primarily for use at an otherwise compatible land use (such as warehouses for compressed gases)
- Explosives and fireworks manufacturing and storage
- Medical and biological research facilities handling substantial quantities of highly toxic or infectious agents

Critical Community Infrastructure

This category includes facilities that, if severely damaged in an aircraft accident, cause significant problems for public health, safety, or welfare beyond the immediate vicinity of the facility. Examples are:

- Water and wastewater treatment plants
- Electrical power generation plants
- Electrical power substations
- Emergency communications facilities
- Public emergency services, including fire and police stations





AIRPORT LAND USE COMMISSION
San Diego County Regional Airport Authority

San Diego International Airport

AIRPORT LAND USE
COMPATIBILITY PLAN

FEBRUARY 2014



APPENDICES



APPENDIX E

Technical Analysis

E4: Airspace Protection Factor Technical Analysis

E4.1 Defining Airspace Protection

In the context of airport land use compatibility, airspace protection refers to the need to protect safe and efficient air navigation around San Diego International Airport (SDIA or the Airport). This is accomplished by limiting the heights of new structures and objects to ensure that they do not become hazards to air navigation.

Four key terms, each with a specific technical meaning, are used in this Appendix.

- Object—An element of natural growth, terrain or man-made structure.
- Obstacle—An object that would penetrate an obstacle clearance surface, or exceed other specific clearance requirements, for a specific flight procedure, as defined by Federal Aviation Administration (FAA) instrument flight procedure design criteria. An obstacle is known as a “controlling obstacle” when a flight procedure is designed around that obstacle as the limiting factor.
- Obstruction—An object that, upon evaluation, is determined by the FAA to require proper marking, lighting, and identification in aeronautical publications so that it may be easily recognized by pilots of aircraft navigating through the airspace. FAA obstruction standards are defined in Title 14, Code of Federal Regulations (CFR) Part 77 (Part 77) Subpart C.

- Hazard—An object exceeding an obstruction standard, or creating other adverse aeronautical effects, that the FAA has determined would have a “substantial adverse effect” to a “significant volume of aeronautical operations”.

E4.2 Federal Regulations and Guidance

The airspace protection policies and standards of this Airport Land Use Compatibility Plan (ALUCP) reflect federal regulations and guidelines. The FAA has standards for assessing airspace obstructions and potential hazards to flight. The federal airspace regulatory framework is provided in Part 77 which describes:

- (a) When notice of construction or alteration must be provided to the FAA (Part 77, Subpart B)
- (b) Standards to determine obstructions to navigable airspace (Part 77, Subpart C)
- (c) FAA’s process to determine the effect of proposed construction or alteration on navigable airspace (Part 77, Subpart D)

In administering Part 77, the prime objectives of the FAA are to promote air safety and the efficient use of navigable airspace. However, the FAA has no authority to restrict or limit proposed construction.

E4.2.1 Federal Reporting Requirements

Part 77, Subpart B, §77.9, requires project sponsors to notify the FAA of any proposal to build or alter a structure or object that is:

- Taller than 200 feet above ground level (AGL)
- Taller than the height of an imaginary surface extending outward and upward from the runway at a slope of 100 to 1 within 20,000 feet of any runway at an airport with at least one runway longer than 3,200 feet (such as the runway at SDIA)

Sponsors may also be required to notify the FAA of other proposed projects because of potential effects on navigational aids or for other reasons specified by the FAA.

If a project sponsor is required to notify the FAA regarding any proposal to build or alter a structure or object per Part 77, Subpart B, §77.9, the sponsor must submit to the FAA a completed FAA Form 7460-1 “Notice of Proposed Construction or Alteration”. The FAA has developed an [on-line tool](#) to assist project sponsors in determining if they are required to notify the FAA. This is a requirement of federal law that applies whether or not state or local laws acknowledge it.¹

Exhibit E4-1 depicts the Part 77, Subpart B, height notification area at SDIA.

¹ Federal Aviation Administration, Department of Obstruction Evaluation/Airport Airspace Analysis (OE/AAA), *Notice Criteria Tool*, <https://oeaaa.faa.gov/oeaaa/external/gisTools/gisAction.jsp?action=showNoNoticeRequiredToolForm>.

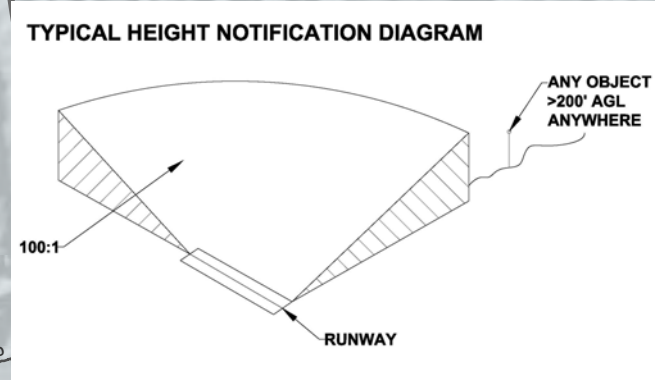
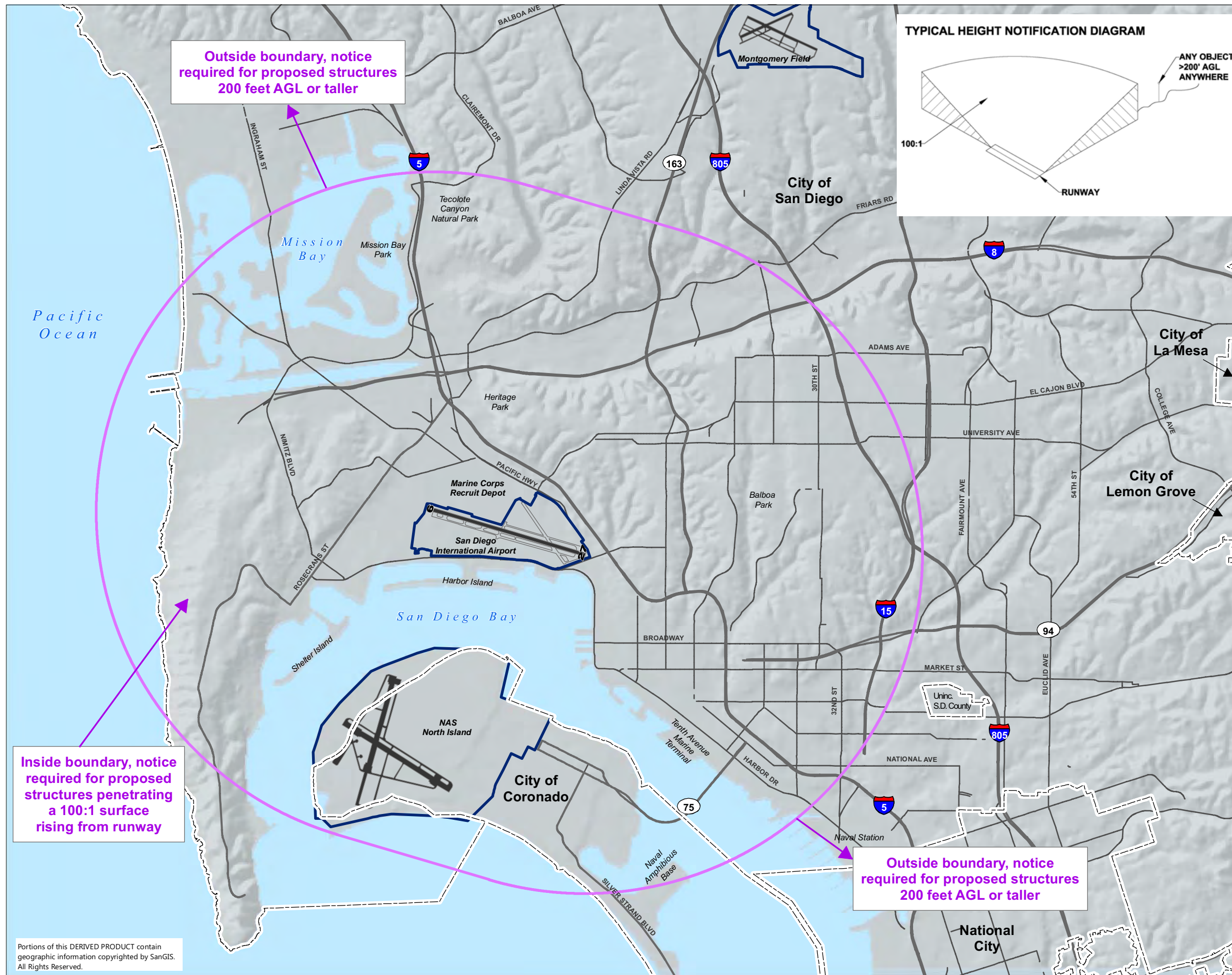

- LEGEND**
- Major Roads
 - Highways
 - - - Municipal Boundaries
 - ▭ Airport Property Boundary
 - Outer Boundary of 100:1 Zone



- Notes:**
1. The Subpart B airspace surface rises from the runway at a slope of 100:1 for a distance of 20,000 feet. The elevation of the east end of the runway is 16.1 feet MSL and the west end is 13.8 feet MSL. Thus, the east edge of the 20,000-foot surface has an elevation of 216.1 feet MSL and the west edge 213.8 feet MSL.
 2. Federal law requires project applicants proposing to build structures exceeding the indicated elevations to file Form 7460-1 with the FAA. FAA then conducts an aeronautical study to determine whether the proposed structure would be an obstruction or a hazard to air navigation.
 3. MSL = Mean Sea Level
 4. Airport elevation is 16.8 feet MSL.
 5. AGL = Above Ground Level

Sources: San Diego Geographic Information Source (SanGIS), 2008 and 2011 (municipal boundaries, roads and highways); Ricondo & Associates, Inc., July 2011 based on FAA Federal Aviation Regulations, Part 77, Objects Affecting Navigable Airspace (Part 77 Subpart B outer boundary).

Prepared by: Ricondo & Associates, Inc., March 2012.

Exhibit E4-1

Part 77 Subpart B

Notification Requirements

Portions of this DERIVED PRODUCT contain geographic information copyrighted by SanGIS. All Rights Reserved.

E4.2.2 Part 77 Obstruction Standards

An obstruction to air navigation is an object that exceeds any of the following federal obstruction standards:

- A height of 499 feet AGL (§77.17(a)(1))
- A height 200 feet AGL or 200 feet above the airport elevation, whichever is higher, within three nautical miles of the airport (§77.17(a)(2))
- A height that encroaches into the required obstacle clearance areas separating designated flight altitudes from obstacles (§77.17(a)(3))
- A height that increases a minimum obstacle clearance under en-route criteria (§77.17(a)(4))
- The surface of a take-off and landing area of an airport or any imaginary surface defined around the airport in accordance with Part 77, Subpart C (§77.17(a)(5))

The airport obstruction standards can be mapped as imaginary airspace surfaces. **Exhibit E4-2** depicts the imaginary surfaces defined according to Part 77 §77.17(a)(5) at SDIA. These are commonly known as Part 77 surfaces. At SDIA, high terrain west, east, and northeast of the Airport penetrates the Part 77 surfaces. By definition, the terrain penetrations are obstructions. Air traffic operational procedures at the Airport have been developed in recognition of these obstructions to assure safe air navigation in the Airport vicinity.

E4.2.3 TERPS Surfaces

The Part 77 obstruction standards refer to obstacle clearance areas and minimum obstruction clearance criteria defined in FAA Order 8260.3B, *U.S. Standard for Terminal Instrument Procedures* (TERPS). TERPS includes criteria for the protection of airspace needed for the safe execution of instrument approach and departure procedures.

Instrument approaches are vital for commercial service airports. Passenger and cargo carriers must be able to depend on access to airports even in adverse weather conditions. The loss of access to a major airport for even limited times of the year can be extremely costly to the carriers, their customers, and the local economy. Protection of this airspace is essential to ensure that the procedures can continue to be used in the future, which, in turn, helps to ensure the continued viability of SDIA.

Unlike Part 77 obstruction surfaces, which can be penetrated without necessarily creating a hazard to air navigation, TERPS surfaces are specifically defined to create a buffer between aircraft and permanent objects on the ground. This buffer is referred to as Required Obstacle Clearance (ROC). The mapped TERPS surfaces represent obstacle clearance surfaces, which incorporate the ROC for each instrument procedure. Objects penetrating TERPS surfaces would create new obstacles requiring adjustment of the flight procedures and reestablishment of the appropriate ROC.

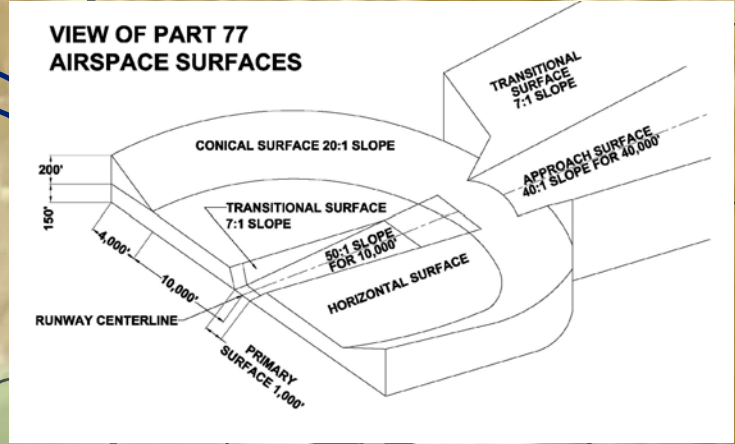
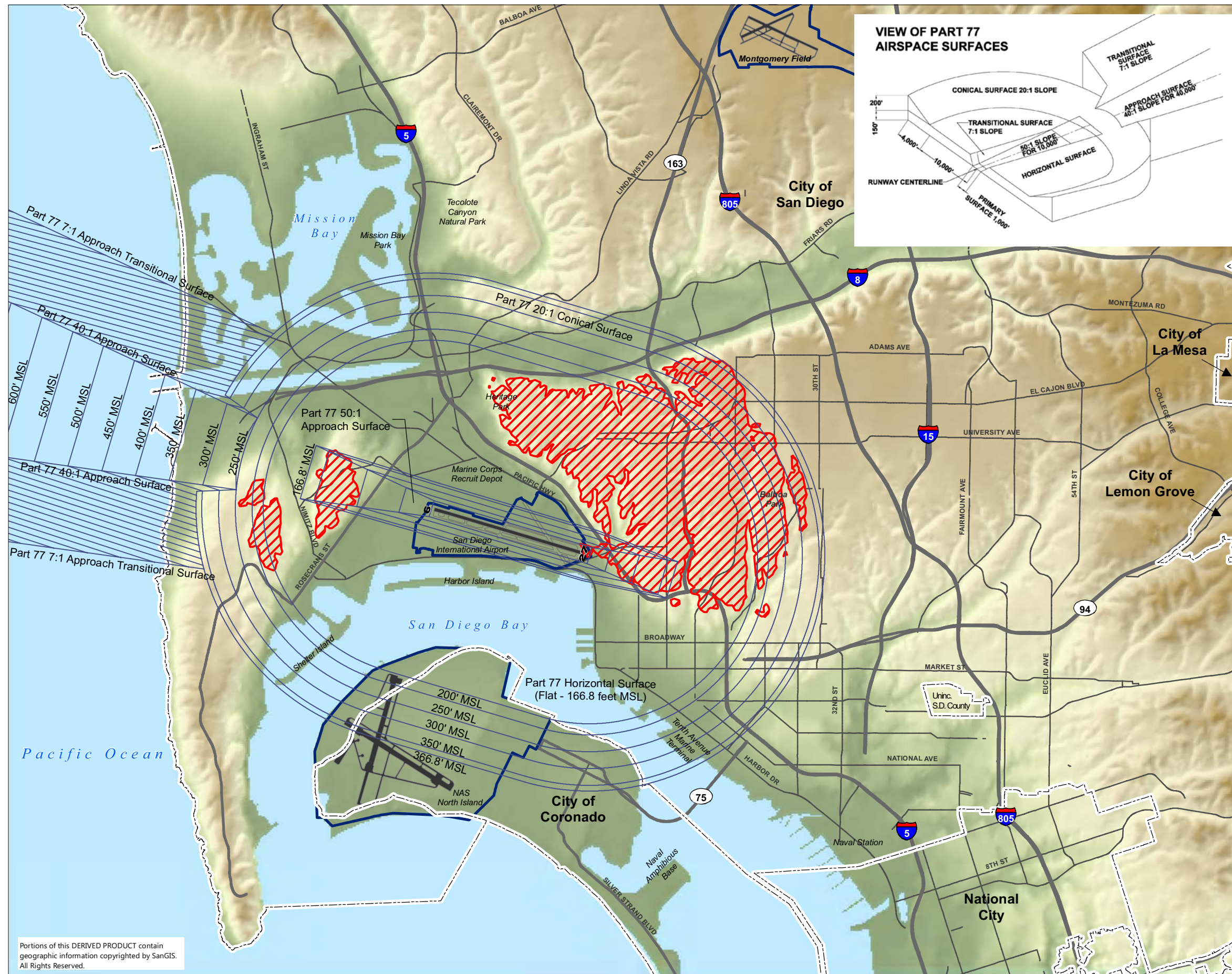

- LEGEND**
- Major Roads
 - Highways
 - Municipal Boundaries
 - Airport Property Boundary
 - Terrain Penetrations of FAR Part 77 Airspace Surfaces
 - Part 77 Airspace Surfaces (elevation in feet MSL)
- Terrain Elevations (in feet MSL)**
- High : 847
 - Low : 1



Notes: 1. MSL = Mean Sea Level
 2. Airport elevation is 166.8 feet MSL

Sources: San Diego Geographic Information Source (SanGIS), 2008 and 2011 (municipal boundaries, roads and highways); Ricondo & Associates, Inc., July 2011 based on FAA Federal Aviation Regulations, Part 77, Objects Affecting Navigable Airspace and San Diego Association of Governments (SANDAG) 30 meter raster elevation data in Digital Elevation Model, November 2010 (Part 77 airspace surfaces and terrain penetrations).

Prepared by: Ricondo & Associates, Inc., March 2012.

Portions of this DERIVED PRODUCT contain geographic information copyrighted by SanGIS. All Rights Reserved.

Exhibit E4-3 depicts the TERPS approach surfaces at SDIA.

As discussed in Section E1.1 of Appendix E1, after the release of the July 2013 Draft ALUCP, on November 7, 2013, the FAA issued a Finding of No Significant Impact (FONSI) for the Runway 9 Displaced Threshold Environmental Assessment related to the relocation of the Runway 9 displaced threshold 300 feet to the east. Exhibit E4-3 was updated to reflect the ultimate Runway 9 displaced threshold, and associated TERPS surfaces.

Runway 27 has nonprecision localizer and lateral navigation (LNAV) approaches. Runway 9 also has nonprecision localizer and LNAV approaches in addition to a precision instrument landing system (ILS). The TERPS surfaces for the nonprecision approaches are all flat surfaces at altitudes ranging from 290 feet to 510 feet above mean sea level (MSL). The TERPS surface associated with the Runway 9 ILS slopes downward toward the runway end at a rate of one foot per ~~31.68~~32.9 feet horizontal.

E4.2.4 FAA Review Process and Determinations

After receiving a completed Form 7460-1, the FAA studies the effect of the proposed construction on the navigable airspace, as described in Part 77, Subpart D. The FAA's Obstruction Evaluation/Airport Airspace Analysis (OE/AAA) process is described in detail in FAA Order JO 7400.2J, *Procedures for Handling Airspace Matters*. **Exhibit E4-4** depicts a flow chart illustrating the steps in the FAA's OE/AAA review process.

After completing its initial OE/AAA report, the FAA issues either a Determination of No Hazard (DNH) to air navigation or, if any obstruction standards are exceeded, a Notice of Presumed Hazard (NPH).²

FAA Determination of No Hazard (DNH)

The FAA issues a DNH when the aeronautical study concludes that the proposed project would be neither hazardous nor cause a substantial adverse impact to air navigation. If the proposed object would not exceed any obstruction standard, the DNH includes a Does Not Exceed (DNE) status determination, with no expiration date and no marking and lighting requirements. If the project has a height of greater than 200 feet AGL, the DNH includes marking and lighting recommendations.

A DNH also may be issued even if the proposed object would exceed an obstruction standard as long as it would not have a substantial adverse impact on air navigation. In such cases, the DNH is issued only after a preliminary NPH and a subsequent, more detailed FAA study or the project sponsor's agreement to resolve the concerns raised in the NPH. In those cases, the DNH may include obstruction marking and lighting recommendations.

² Federal Aviation Administration, Order JO 7400.2J, *Procedures for Handling Airspace Matters*, Paragraph 7-1-3.

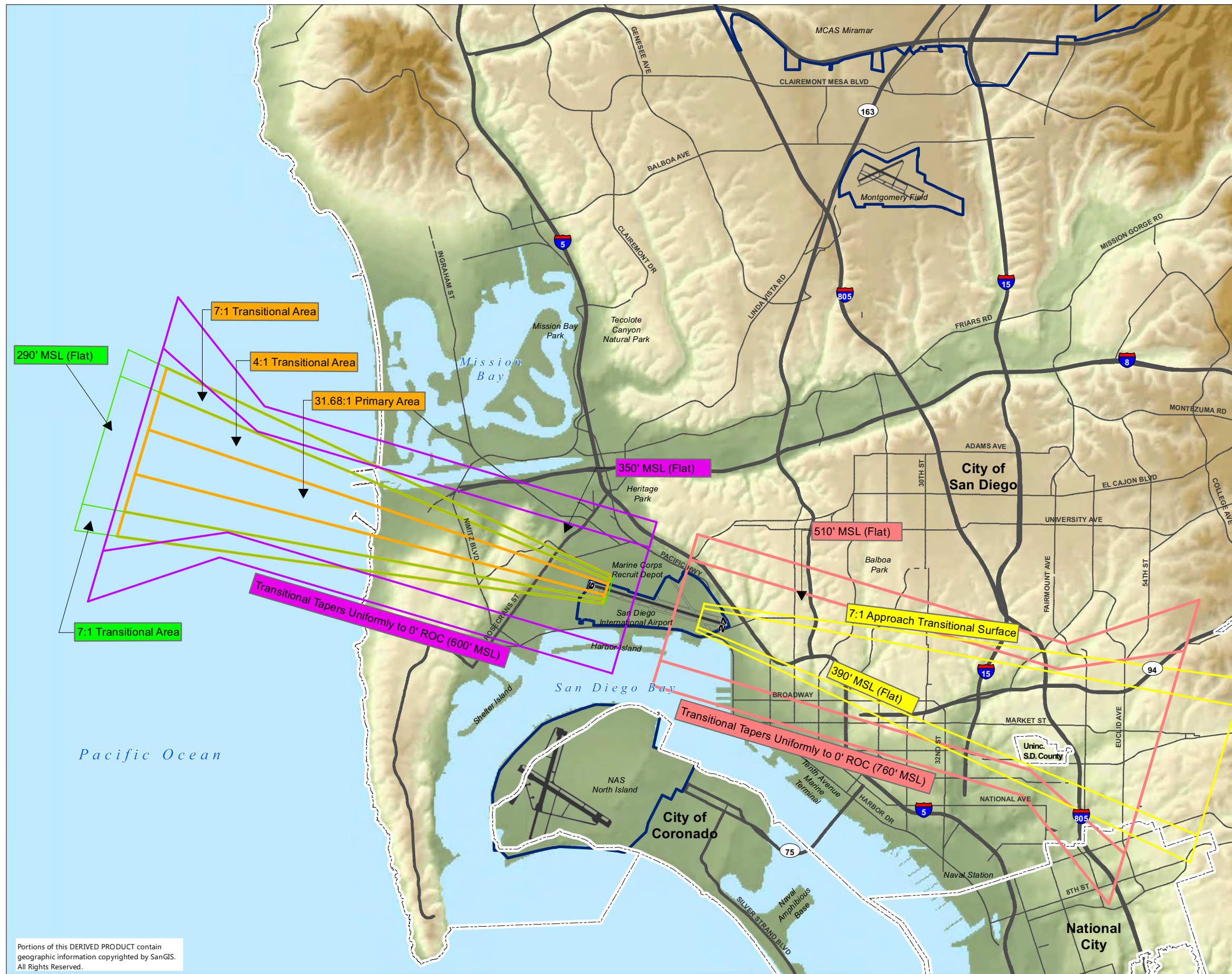

LEGEND

- Major Roads
- Highways
- - - Municipal Boundaries
- ▭ Airport Property Boundary

TERPS Approach Surfaces

- ▬ RWY 27 LOC Approach
- ▬ RWY 27 LNAV Approach
- ▬ RWY 9 LOC Approach
- ▬ RWY 9 LNAV Approach
- ▬ RWY 9 ILS Approach

Terrain Elevations (in feet MSL)

- High : 1260
- Low : 1



- Notes: 1. High Terrain Zones (TERPS) = Terrain within 100 feet of airspace surface
 2. ROC = Required Obstacle Clearance
 3. MSL = Mean Sea Level
 4. Airport elevation is 16.8 feet MSL

Sources: San Diego Geographic Information Source (SanGIS), 2008 and 2011 (municipal boundaries, roads and highways); Ricondo & Associates, Inc., July 2011 based on Federal Aviation Administration (FAA), Order 8260.3B, United States Standards for Terminal Instrument Procedures (dated June 5, 2009) and San Diego Association of Governments (SANDAG) 30 meter raster elevation data in Digital Elevation Model, November 2010 (TERPS approach surfaces).

Prepared by: Ricondo & Associates, Inc., December 2013.

Portions of this DERIVED PRODUCT contain geographic information copyrighted by SanGIS. All Rights Reserved.

**Exhibit E4-3
TERPS Approach Surfaces**

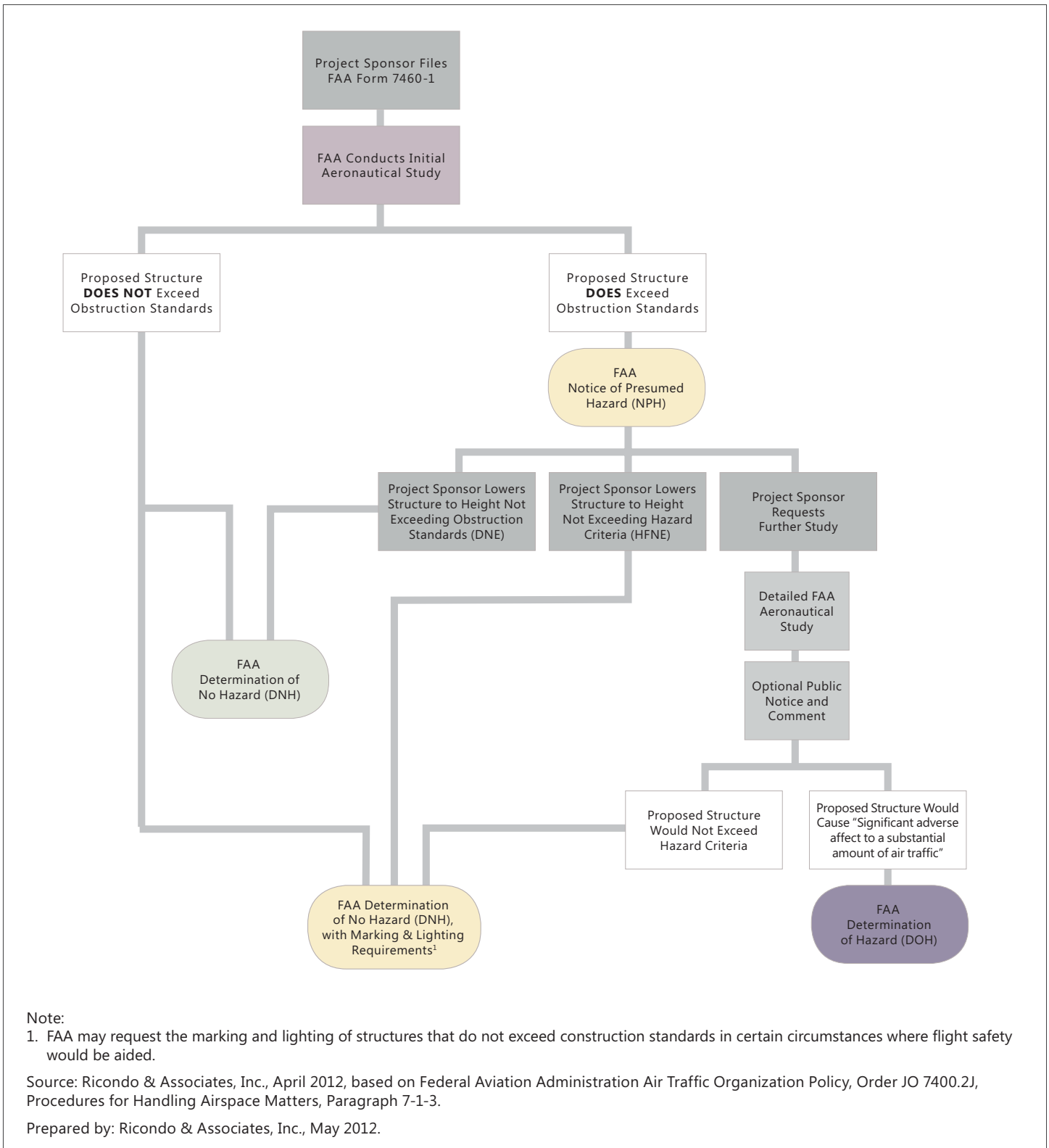

Exhibit E4-4

Process for FAA Review of Proposed Construction or Alteration

FAA Notice of Presumed Hazard (NPH)

The FAA issues an NPH when the aeronautical study concludes that a proposed project exceeds obstruction standards. The NPH either recommends lowering the proposed object to the height not exceeding obstruction standards (DNE height) or cite a maximum “height for not exceeding” (HFNE) with respect to hazard criteria. The HFNE height may be noted if the proposal is near existing objects or other proposed objects that the FAA has already studied and for which it has already calculated hazard limitations.

After receiving an NPH, the project sponsor has the following options:

1. Lower the proposed height of the object so that it would not exceed obstruction standards (the DNE elevation). This routinely results in the FAA issuing a DNH
2. Lower the height of the object to the HFNE height, if one was indicated on the NPH. This routinely results in the FAA issuing of a DNH, with marking and lighting requirements
3. Request the FAA to perform further aeronautical study at the originally requested height
4. Request the FAA to perform further aeronautical study for an object at a height lower than the original proposal but not as low as the alternative height noted on the NPH letter

Upon receiving a request for further aeronautical study, the FAA initiates a complex study analyzing flight procedures, navigational aids (NAVAIDS), radar, and other factors in the airspace in the vicinity of the proposed object. The objective of this detailed aeronautical study is to determine whether the proposed object would have a significant adverse effect on a substantial amount of air traffic, and thereby constitute a hazard to air navigation. The most frequently applied criteria for hazard status determinations are TERPS criteria, but other criteria, such as visual flight rules (VFR) clearances, NAVAID considerations and air traffic procedures can be cited. Per Part 77, Subpart D, these factors can include:

1. The impact on arrival, departure and en route procedures for aircraft operating under VFR
2. The impact on arrival, departure and en route procedures for aircraft operating under instrument flight rules (IFR)
3. The impact on existing and planned public-use airports
4. Airport capacity of existing public-use airports and public-use airport development plans received before the issuance of the final determination
5. Minimum obstacle clearance altitudes, minimum IFR altitudes, approved or planned instrument approach procedures and departure procedures

6. The potential effect on air traffic control (ATC) radar, direction finders, ATC tower line-of-sight visibility and physical or electromagnetic interference (EMI) effects on air navigation and communication facilities
7. The aeronautical effects resulting from the cumulative impact of a proposed construction or alteration of an object when combined with the effects of other existing or proposed objects³

During the detailed aeronautical study, the FAA may circulate the proposal under the Public Notice process. A Public Notice describes the proposal and the amount by which it exceeds obstruction standards and other effects of the proposal. The Public Notice is posted on the publicly available portion of the FAA's OE/AAA [website](#), and can also be sent directly to interested stakeholders.⁴

Interested stakeholders may submit comments on the proposal. Public Notice is the formal, and sometimes the only opportunity for third-party stakeholders (those other than the FAA and the project sponsor) to provide input in the OE/AAA process. The FAA must consider any comment of a significant aeronautical nature.

The FAA concludes the detailed aeronautical study process with a determination as to whether the proposed construction would constitute a hazard to air navigation. The FAA issues a Determination of Hazard to Air Navigation (DOH) where the detailed aeronautical study concludes that the proposed construction or alteration would exceed an obstruction standard and have a substantial aeronautical impact, and where negotiations with the project sponsor have failed to result in acceptance of a height not exceeding obstruction standards or hazard standards.

The FAA has no direct jurisdictional authority through which it can require the project sponsor to alter the proposed object to eliminate the hazard. That power rests with state and local land use regulatory agencies. Although the FAA has no direct land use regulatory authority, it can exert leverage on jurisdictions with land use regulatory authority that are also airport operators. The failure of an airport operator with land use regulatory authority to enforce an FAA DOH could be interpreted as a violation of Grant Assurances 20 and 21, which bind the airport operator to protect the approaches to the airport and to promote airport land use compatibility.⁵ These grant assurances are binding on the San Diego County Regional Airport Authority (SDCRAA) because it has accepted federal airport grant money in the past.

³ Title 14, Code of Federal Regulations, Part 77, *Safe, Efficient Use, and Preservation of Navigable Airspace*, Subpart D, *Aeronautical Studies and Determinations*, §77.29.

⁴ Federal Aviation Administration, Department of Obstruction Evaluation/Airport Airspace Analysis (OE/AAA), <https://oeaaa.faa.gov/oeaaa/external/searchAction.jsp?action=showSearchProposedCasesForm>.

⁵ Federal Aviation Administration, Department of Obstruction Evaluation/Airport Airspace Analysis (OE/AAA), *Grant Assurances*, http://www.faa.gov/airports/aip/grant_assurances/.

E4.2.5 Runway Threshold Siting Standards (TSS)

FAA Advisory Circular (AC) 150/5300-13A, *Airport Design*, provides planning standards and criteria for siting the ends of runways to ensure the safe clearance of obstacles by aircraft approaching and departing from the runway.⁶ The criteria vary depending on the visibility minimums and level of precision of the approach. In planning new runways, the runway thresholds are established to ensure that the threshold siting surface (TSS) is free of any penetrations by obstacles.

Exhibit E4-5 depicts the TSS for each runway end at SDIA based on the current displaced runway thresholds and the applicable FAA criteria, as well as the height of each TSS above the underlying terrain, as follows:

- Runway 9: The TSS for Runway 9 (on the west side of the Airport) has a slope of 34 to 1, based on the precision ILS approach to the runway. It begins at a point 200 feet west of the 700-foot displaced threshold. The Runway 9 TSS is at least 25 feet above the underlying terrain except for a small part of the Marine Corps Recruit Depot where the TSS is 10 to 20 feet above the ground.
- Runway 27: The TSS for Runway 27 (on the east side) has a slope of 20 to 1, beginning at a point 200 feet east of the 1,810-foot displaced threshold. The slope is steeper than for Runway 9 because of the current lack of, and the future infeasibility of, a precision approach to Runway 27. The Runway 27 TSS is approximately 30 feet or more above the ground off Airport property.

The TSS can differ from the TERPS obstacle clearance surface for any given runway approach, as the operational glideslope is sometimes greater than the nominal glideslope assumed under the TSS planning criteria (a standard 3 degrees).⁷ When this situation occurs, as it does at SDIA, use of the TSS as an airspace protection surface for airport compatibility planning can be a conservative way to protect for the possibility of long-range improvements in the runway approaches, while providing an extra buffer between aircraft on approach and the nearest underlying buildings.

As discussed in Section E1.1 of Appendix E1, after the release of the July 2013 Draft ALUCP, on November 7, 2013, the FAA issued a Finding of No Significant Impact (FONSI) for the Runway 9 Displaced Threshold Environmental Assessment related to the relocation of the Runway 9 displaced threshold 300 feet to the east. Exhibit E4-5 was updated to reflect the ultimate Runway 9 displaced threshold, and associated TSS for Runway 9.

⁶ Federal Aviation Administration, Advisory Circular 150/5300-13A, *Airport Design*, Paragraph 303.

⁷ Although the slopes of the TSS surfaces are different for each runway end at SDIA, both are designed to accommodate a 3-degree glideslope. The shallower slope for the Runway 9 approach reflects the stricter obstacle clearance standards applying to a precision approach.

E4.3 State Regulations and Guidance

The State Aeronautics Act recognizes the Part 77 obstruction and hazard standards and provides the basis for local agencies and the California Department of Transportation (Caltrans) to enforce their protection. State law prohibits the construction or alteration of structures or objects that exceed Part 77 obstruction standards unless a permit is issued by Caltrans. The permit may be waived for a structure or object less than 500 feet above the ground if the FAA determines it would not be a hazard to air navigation.⁸ To date, Caltrans has never issued a permit under these circumstances.

⁸ California Public Utilities Code §§21657, 21659(b).

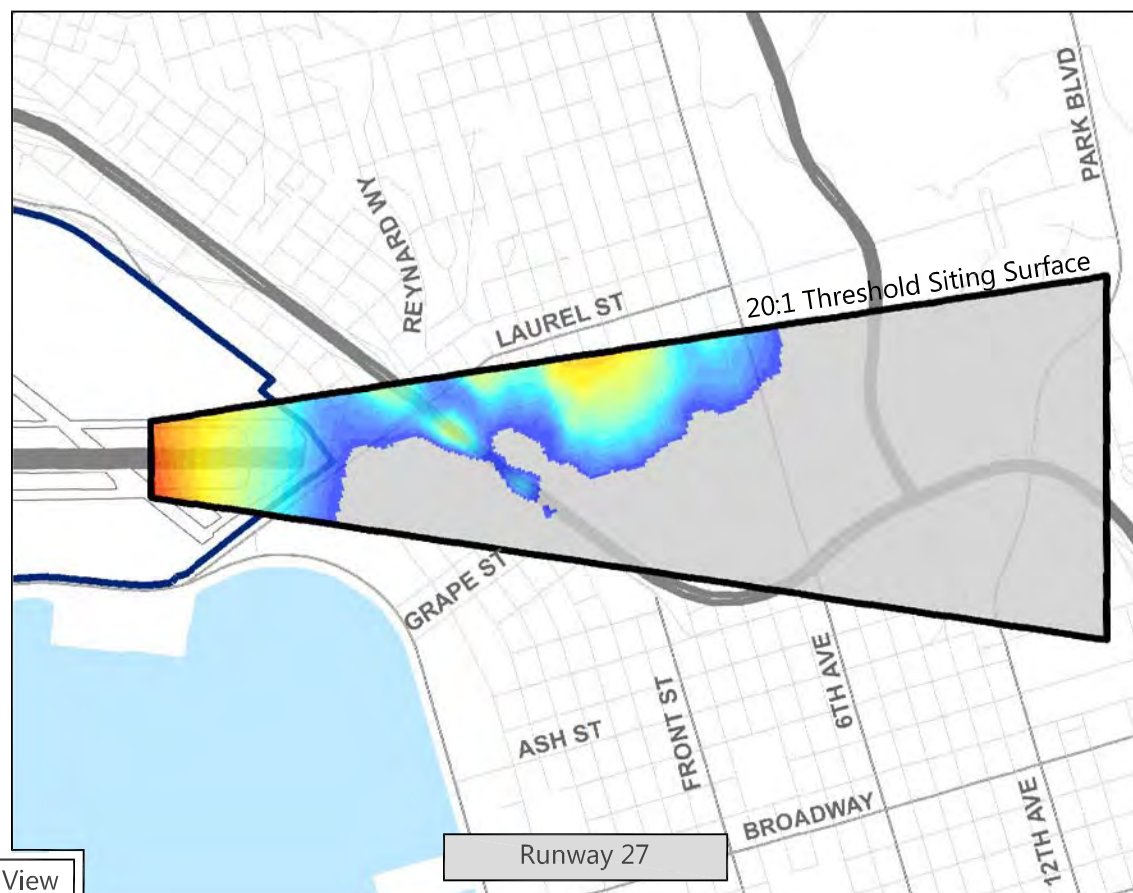
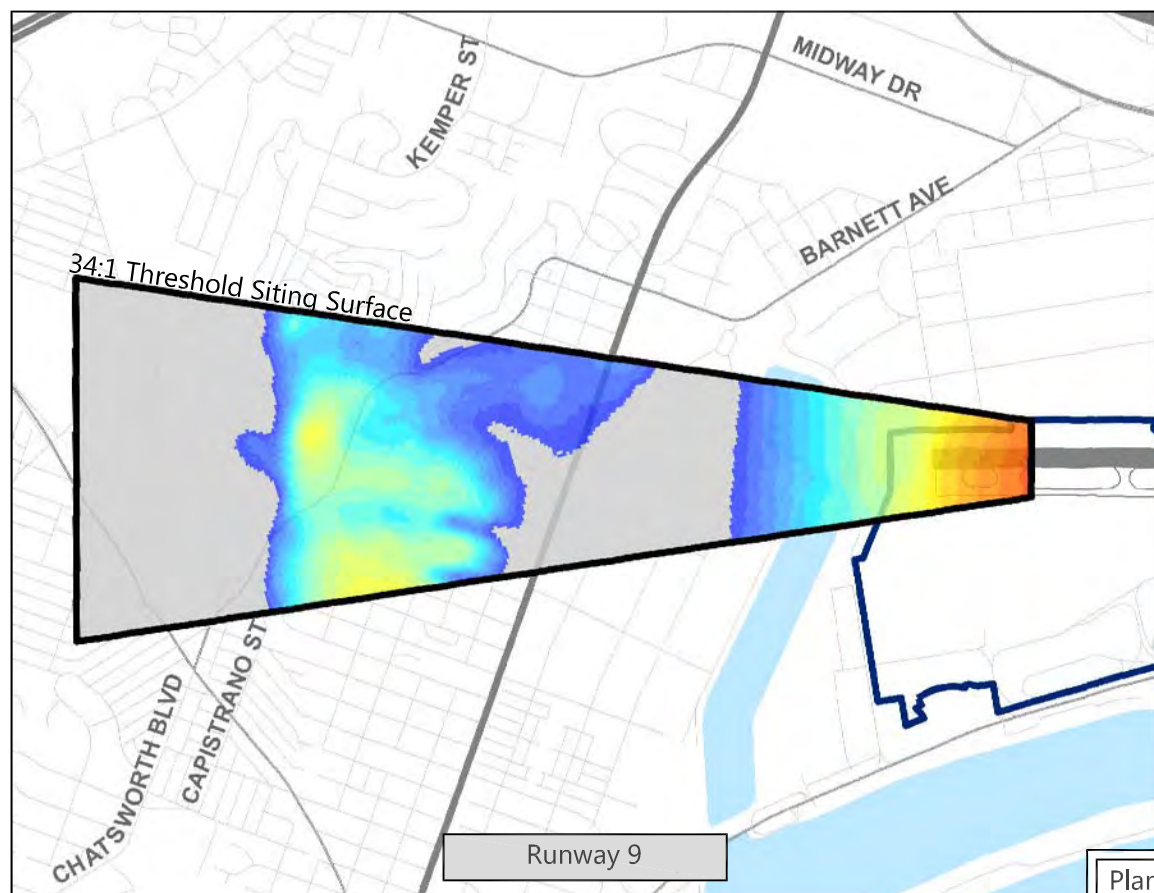

LEGEND

- Major Roads
- Highways
- Airport Property Boundary
- Threshold Siting Surface

Heights of Airspace Surface Above Ground Level (AGL)

- 0-10
- 10-15
- 15-20
- 20-25
- 25-30
- 30-35
- 35-40
- 40-45
- 45-50
- 50-55
- 55-60
- 60-65
- 65-70
- 70-75
- 75-80
- 80-85
- 85-90
- 90-95
- 95-100
- 100+



Notes:

1. Ground profile depicts terrain along extended runway centerline.
2. Threshold Siting Surfaces (TSSs) are surfaces that rise away from each runway end. A project located in close proximity to the end of the runway would have a smaller height buffer available compared to a project located further away from the runway. The available height buffer would be further reduced if the project is located in an area of high terrain. To help assess how much buffer or height would be available between the ground surface and the TSS surfaces above, calculations were made to subtract the ground elevation from the TSS surface elevation.

Sources: San Diego Graphic Information Source (SanGIS), 2008 and 2011 (municipal boundaries, roads, and highways); Ricondo & Associates, Inc. April 2012, based on San Diego Association of Governments (SANDAG) 30 meter raster elevation data in Digital Elevation Model, November 2010; Federal Aviation Administration Advisory Circular 150/5300-13A *Airport Design* (Threshold Siting Surface).

Prepared by: Ricondo & Associates, Inc., December 2013.

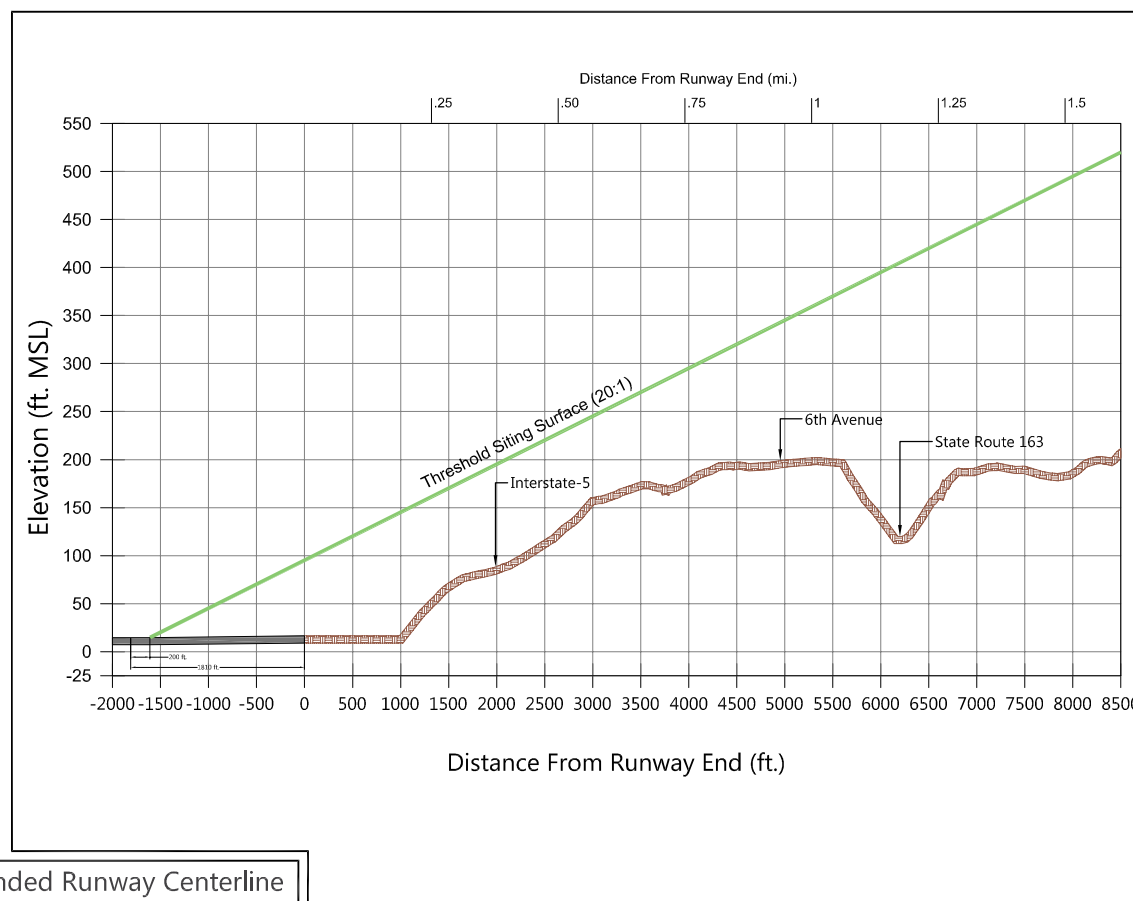
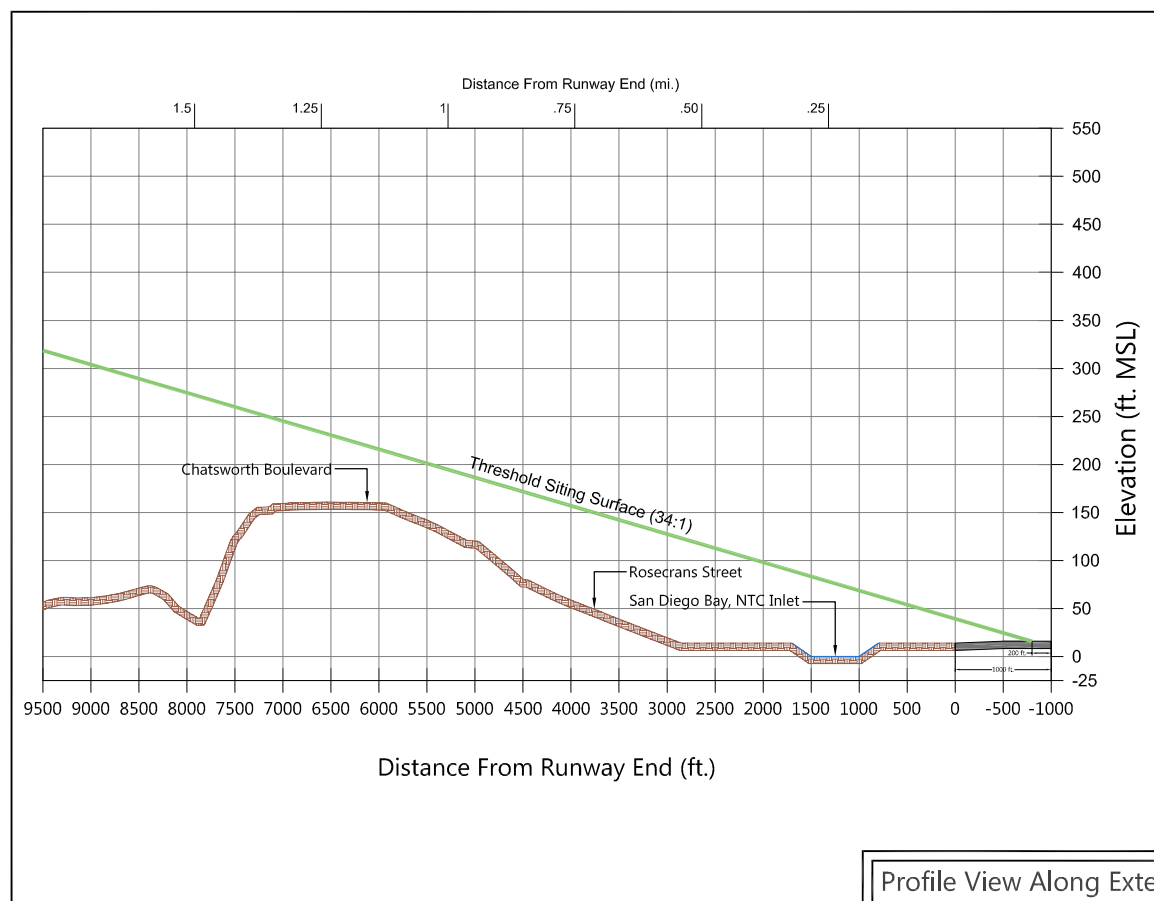

Profile View Along Extended Runway Centerline

Exhibit E4-5

Threshold Siting Surfaces

The 2011 edition of the *California Airport Land Use Compatibility Planning Handbook* (the Handbook) defers largely to FAA guidance concerning airspace protection. The Handbook advises the following:

- The compatibility strategy should be to limit the height of structures and objects so as not to cause hazards to flight
- The airspace protection boundary should correspond to the Part 77 imaginary surfaces, with consideration given to TERPS surfaces at airports where those surfaces are lower than the Part 77 surfaces
- Airport Land Use Commissions (ALUCs) should consider the potential for certain land uses to include features that may create hazards to flight, such as bird attractants, interference with visibility (distracting lights, smoke, or glare) and electromagnetic interference with aircraft and air traffic control communications and navigation instruments

E4.4 Technical Analysis

The following sections present the various SDIA airspace surface profiles and the proposed airspace protection boundary.

E4.4.1 SDIA Airspace Surface Profiles

The vertical relationships of the SDIA airspace surfaces to the terrain and to each other are depicted in **Exhibits E4-6** and **E4-7**. Each exhibit shows a cross-section along the extended runway centerline.

Exhibit E4-6 depicts the approach to Runway 9 from the west and the following surfaces:

- The Part 77, Subpart B, notification surface is the lowest surface, rising at a slope of 100 to 1 from the runway. The Part 77 surface rises from a point 200 feet west of the runway end at a slope of 50 to 1, leveling off approximately 7,800 feet west of the runway end. The high terrain in Point Loma penetrates the Part 77 surface.
- The TSS rises at a slope of 34 to 1 from a point 500 feet east of the runway end and 200 feet west of the 700-foot displaced threshold.
- The TERPS ILS Obstacle Clearance Surface (OCS) is just slightly higher than the TSS, rising at a slope of 31.68 to 1 from the same point as the TSS. (This reflects the difference of the 3.22-degree ILS glideslope from the TSS planning criterion of 3 degrees.) Because the LNAV and Localizer approaches are both nonprecision approaches (lacking vertical descent guidance) both the TERPS OCS surfaces for those procedures are horizontal.
- The actual glide path of aircraft on approach to land on Runway 9. The angle descends at a slope of 3.22 degrees to a point on the runway approximately 2,000 feet east of the runway end.

Per the discussion provided in Sections E4.2.3 and E4.2.5 above, Exhibit E4-6 was updated to reflect the Runway 9 TERPS and TSS surfaces associated with the ultimate Runway 9 displaced threshold.

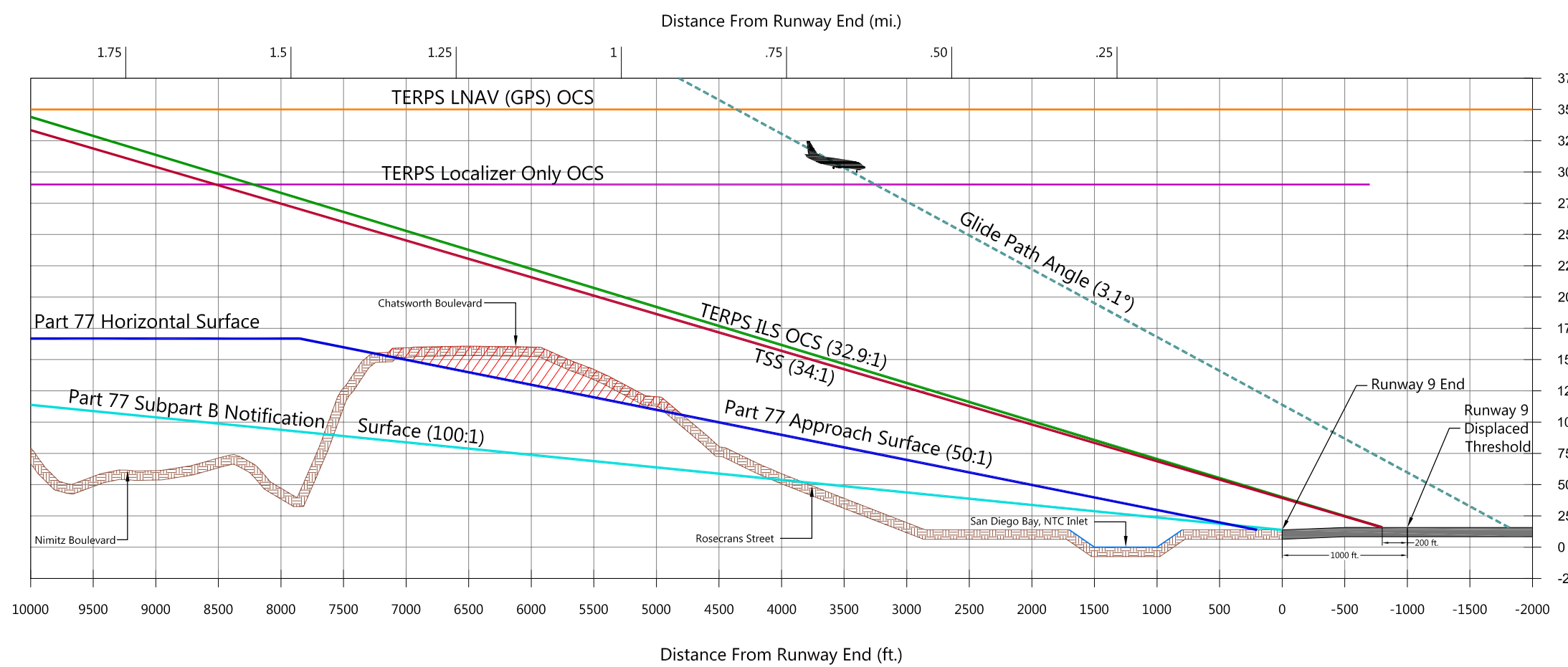

- LEGEND**
- Part 77 Approach and Horizontal Surfaces
 - TERPS Instrument Landing System (ILS) OCS
 - TERPS Localizer Only (LOC) Surface
 - TERPS Lateral Navigation (LNAV) Surface
 - Part 77 100:1 Subpart B Notification Surface
 - Threshold Siting Surface (TSS)
 - - - Glide Path Angle
 - ▨ Ground Profile Along Extended Runway Centerline
 - ▧ Part 77 Terrain Penetration



- Notes:**
1. Vertical scale exaggerated 10 times.
 2. Profile depicted along extended runway centerline.
 3. LNAV and LOC Surfaces contain a (34:1) visual portion of the final approach segment which is treated as an obstacle identification surface.
 4. OCS: Obstacle Clearance Surface
 5. TERPS: Terminal Instrument Procedures

Sources: Ricondo & Associates, Inc., July 2011, based on Federal Aviation Administration (FAA), Order 8260.3B, United States Standards for Terminal Instrument Procedures, June 5, 2009; FAA Federal Aviation Regulations, Part 77, Safe, Efficient Use, and Preservation of Navigable Airspace, June 2011; San Diego Association of Governments (SANDAG) 30 meter raster elevation data in Digital Elevation Model, November 2010 (Part 77 surfaces and terrain penetrations; TERPS surfaces; threshold siting surface; airport approach overlay zone; and glide path angle).

Prepared by: Ricondo & Associates, Inc., December 2013.

Exhibit E4-6
Runway 9 Airspace
Surfaces Profile

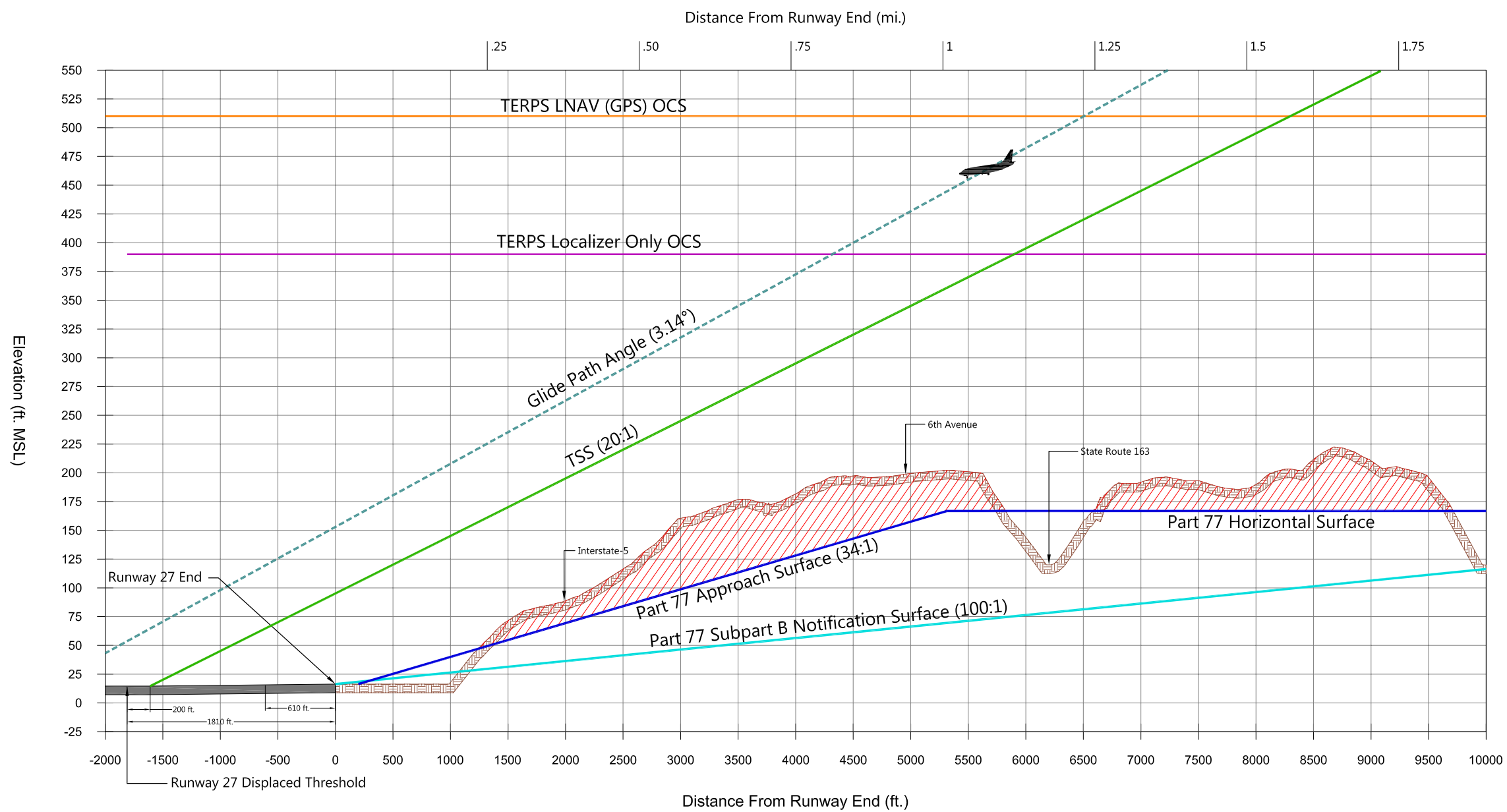

- LEGEND**
- Part 77 Approach and Horizontal Surfaces
 - Threshold Siting Surface (TSS)
 - TERPS Localizer Only (LOC) Surface
 - TERPS Lateral Navigation (LNAV) Surface
 - Part 77 100:1 Subpart B Notification Surface
 - - - Glide Path Angle
 - Ground Profile Along Extended Runway Centerline
 - Part 77 Terrain Penetration



- Notes:**
1. Vertical scale exaggerated 10 times.
 2. Profile depicted along extended runway centerline.
 3. LNAV and LOC Surfaces contain a (34:1) visual portion of the final approach segment which is treated as an obstacle identification surface.
 4. OCS: Obstacle Clearance Surface
 5. TERPS: Terminal Instrument Procedures

Sources: Ricondo & Associates, Inc., July 2011, based on Federal Aviation Administration (FAA), Order 8260.3B, United States Standards for Terminal Instrument Procedures, June 5, 2009; FAA Federal Aviation Regulations, Part 77, Safe, Efficient Use, and Preservation of Navigable Airspace, June 2011; San Diego Association of Governments (SANDAG) 30 meter raster elevation data in Digital Elevation Model, November 2010 (Part 77 surfaces and terrain penetrations; TERPS surfaces; threshold siting surface; airport approach overlay zone; and glide path angle).

Prepared by: Ricondo & Associates, Inc., March 2012.

Exhibit E4-7
Runway 27 Airspace
Surfaces Profile

Exhibit E4-7 depicts the approach to Runway 27 from the east and the following surfaces:

- The Part 77, Subpart B, notification surface is below the surface of the ground through nearly all of the area. The Part 77 surface is also beneath the ground in most of the area.
- The two TERPS obstacle clearance surfaces are horizontal, since they are associated with nonprecision approaches. The TERPS localizer approach is the lower of the two, based on the lower visibility minimums for that approach.
- The TSS rises at a slope of 20 to 1 from a point 200 feet east of the displaced threshold (1,610 feet west of the runway end).
- The actual glide path followed by aircraft descends at 3.14 degrees to a point on the runway approximately 3,500 feet west of the runway end.

E4.4.2 Proposed Airspace Boundary

Exhibit E4-8 depicts all airspace protection surfaces discussed in the previous sections. Per the discussion provided in Sections E4.2.3 and E4.2.5 above, Exhibit E4-8 was updated to reflect the Runway 9 TERPS and TSS surfaces associated with the ultimate Runway 9 displaced threshold. **Exhibit E4-9** presents the proposed airspace protection boundary. It represents the outer boundary of the combined Part 77 Subpart B notification boundary, the Part 77 imaginary airspace surfaces, and the TERPS approach surfaces. The exhibit also depicts the TSS boundaries off each runway end, within which specific height limitations would apply.

E4.5 Airspace Protection Policy Considerations

The objective of the airspace protection policies and standards is to ensure new development around SDIA does not interfere with safe and efficient air navigation. This can be accomplished by ensuring local agency adherence to federal airspace protection guidance and regulations. Other policies and standards are needed to ensure that certain land use characteristics do not create non-structural hazards to aircraft in flight near the Airport.

The Handbook advises ALUCs to establish airspace protection policies that would limit building heights to ensure that new structures or objects do not become hazards to air navigation. An effective way to accomplish this is to ensure that the FAA hazard and obstruction determinations are enforced as ALUCP policy. This approach, which has been taken in this ALUCP, has the following advantages:

- It ensures that structures or objects tall enough to potentially become obstructions or hazards are studied by FAA experts before being permitted by local agencies
- It ensures that recommendations of the FAA regarding marking and lighting are recognized by local agencies issuing the development permits
- It provides builders and developers with maximum flexibility, consistent with airspace

protection imperatives⁹

- It ensures that hazards to air navigation are not constructed
- It ensures the Airport operator is informed

⁹ An alternative policy used by many local governments is simply to adopt maximum height limits based on the Part 77 Subpart C imaginary surfaces, with the intent of providing a buffer to ensure that obstructions, in addition to hazards, are avoided. This approach is not practical at SDIA because of the hilly terrain that penetrates the Part 77 imaginary surfaces.



LEGEND

- Major Roads
- Highways
- - - Municipal Boundaries
- ▭ Airport Property Boundary
- ▭ Proposed Airspace Protection Boundary³
- ▭ Threshold Siting Surface
- ▭ Outer Boundary of Part 77 Airspace Surfaces

Outer Boundaries of TERPS Surfaces

- ▭ Runway 27 LOC Approach
- ▭ Runway 27 LNAV Approach
- ▭ Runway 9 LOC Approach
- ▭ Runway 9 LNAV Approach
- ▭ Runway 9 ILS Approach

Terrain Elevations (in feet MSL)

- ▭ High : 847
- ▭ Low : 1



- Notes:
1. MSL = Mean Sea Level
 2. Airport elevation is 16.8 feet MSL.
 3. The Airspace Protection Boundary is defined as the combined Part 77 Subpart B, Subpart C and TERPS approach surface boundaries.

Sources: San Diego Geographic Information Source (SanGIS), 2008 and 2011 (municipal boundaries, roads and highways); San Diego Association of Governments (SANDAG), 2010 (terrain data); Ricondo & Associates, Inc., July 2011 based on Exhibits A-14 through A-16 (proposed airspace protection boundary; threshold siting surface; outer boundaries of Part 77 and TERPS surfaces).

Prepared by: Ricondo & Associates, Inc., December 2013.

Portions of this DERIVED PRODUCT contain geographic information copyrighted by SanGIS. All Rights Reserved.

Exhibit E4-8
Proposed Airspace Protection
Boundary Details

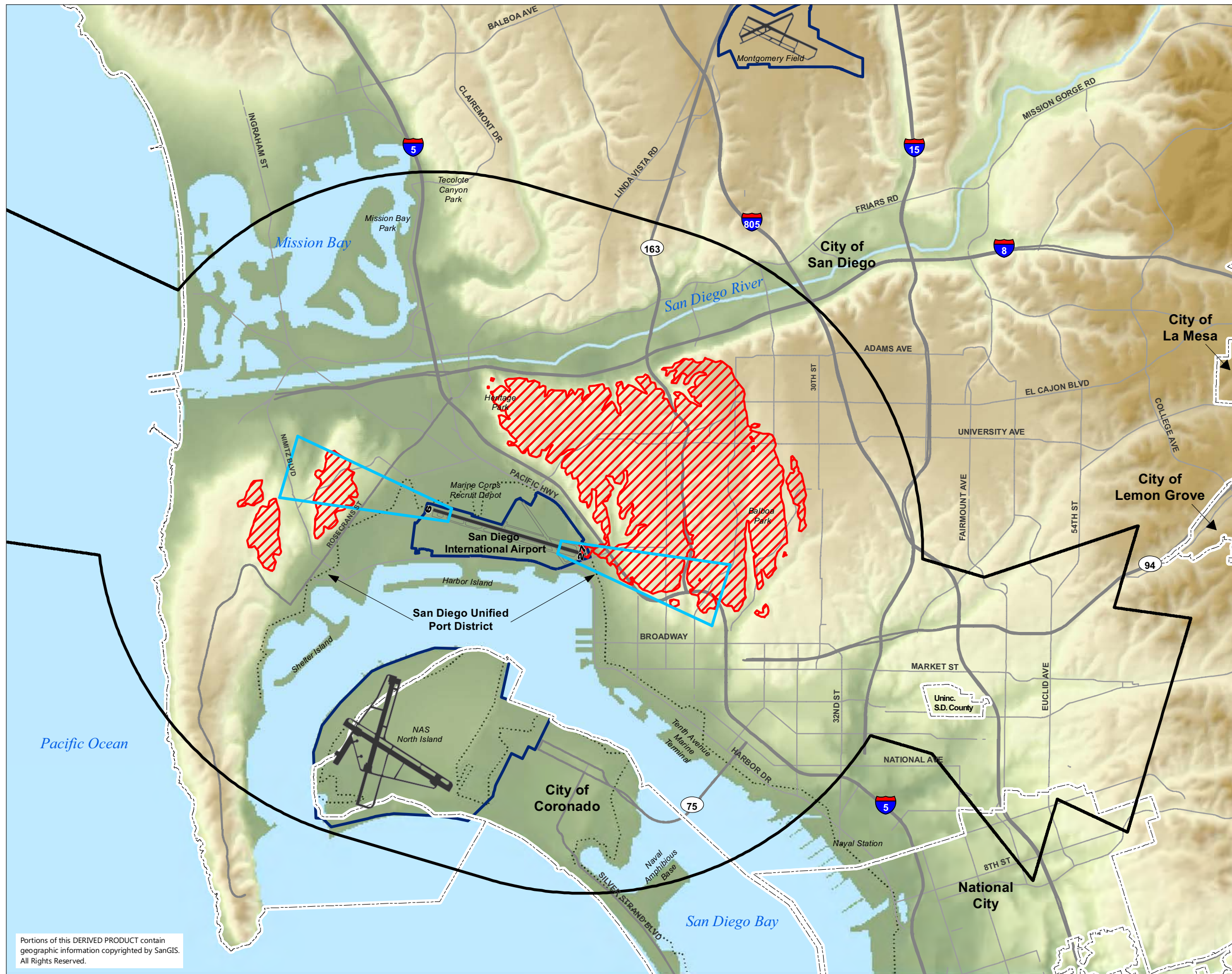

LEGEND

- Major Roads
- Highways
- - - Municipal Boundaries
- ▭ Proposed Airport Property Boundary
- ▭ Airspace Protection Boundary¹
- ▭ Threshold Siting Surface
- ▨ Terrain Penetrations of FAR Part 77 Surfaces

Terrain Elevations (in feet MSL)

- High : 847
- Low : 1



Notes: 1. The Airspace Protection Boundary is defined as the outer boundary of the combined Part 77 Subpart B, Subpart C and TERPS approach surface boundaries.

Sources: San Diego Geographic Information Source (SanGIS), 2008 and 2011 (municipal boundaries, roads and highways); Ricondo & Associates, Inc., July 2011 (airspace protection boundary and threshold siting surface; terrain penetrations based on San Diego Association of Governments (SANDAG) 30 meter raster elevation data in Digital Elevation Model).

Prepared by: Ricondo & Associates, Inc., December 2013.

Portions of this DERIVED PRODUCT contain geographic information copyrighted by SanGIS. All Rights Reserved.

Exhibit E4-9 Proposed Airspace Protection Boundary

The airspace protection policy for SDIA also provides an extra margin of protection for the approaches to each runway end. Maximum height limits are established beneath the TSS for each runway to ensure that no obstructions that could become future obstacles are erected in those areas. The protection of those approach surfaces is important to protect for the possibility of long-term improvements in the approaches to each runway, such as the reduction of visibility minimums and the lowering of glideslope angles. At the same time, the use of the TSS as a regulatory height limit provides an extra margin of protection for underlying development by providing an additional vertical buffer from arriving aircraft.

In accordance with Handbook guidance, ALUCP policies also address land use characteristics with the potential to interfere with the safety of flight in the airspace around SDIA.¹⁰ These characteristics include:

- Glare of such severity as to interfere with pilot vision
- Lights that may be mistaken for airport identification and navigational lighting
- Dust, smoke and vapor that may obstruct pilot vision
- Thermal plumes with the potential to interfere with aircraft control
- Electromagnetic interference with communications and navigational signals
- Wildlife (especially bird) attractants

To the extent possible, performance standards and design criteria have been developed to provide the ALUC and local agencies with guidance in determining when these characteristics may become problematic for aircraft in flight. The experience of the California Energy Commission in power plant licensing cases is helpful in setting standards for glare and thermal plumes. The FAA has developed helpful guidance relating to the avoidance of hazardous wildlife attractants near airports.¹¹ Where uncertainties remain regarding what constitutes a potential flight hazard, this ALUCP recommends local agency consultation with FAA officials and SDCRAA/Airport operator.

¹⁰ California Department of Transportation, Division of Aeronautics, *California Airport Land Use Planning Handbook*, October 2011, pp. 3-35, 4-35 - 4-40.

¹¹ Federal Aviation Administration, Advisory Circulars 150/5200-34, *Construction or Establishment of Landfills near Public Airports* and 150/5300-33, *Hazardous Wildlife Attractants on or near Airports*.



APPENDIX E

Technical Analysis

E5: Overflight Compatibility Factor Technical Analysis

E5.1 Defining Overflight

In the context of airport land use compatibility, overflights are any distinctly visible or audible passage of aircraft through an area. Under this definition, the aircraft does not need to be directly above the receiver to be considered an overflight nor does the receiver need to be within the Community Noise Equivalent Level (CNEL) contour which represents the noise impact zone.¹

E5.2 State Regulations and Guidance

The State of California has no specific laws or regulations restricting or regulating aircraft overflights. The state does have a real estate disclosure law, however, which is intended to inform prospective buyers of new and existing residential property of the presence of nearby airports and the potential for airport-related impacts. Within the airport influence area (AIA) established in the applicable ALUCP, the state real estate disclosure law applies to the:

- Sale or lease of subdivided lands and condominium conversions
- Sale of residential properties with one to four dwellings units
- Sale of condominium and other common interest residential properties²

¹ The current Airport Land Use Compatibility Plan for SDIA defines the outer noise impact zone as the 60 dB CNEL contour. Refer to the *1992 San Diego International Airport Land Use Compatibility Plan* as amended 1994 and 2004.

² California Business and Professions Code §11010; California Civil Code §§1102, 1102.6, 1103.4, 1353; California Code of Civil Procedure §731a.

The law requires that sellers of residential property and their agents disclose if the property is situated within an AIA. This measure is intended to provide the purchaser with notice that the property is in the vicinity of an airport and may be subject to airport related effects, including overflights.

See:

- California Business and Professions Code Section 11010
- California Civil Code Section 1102.6
- California Civil Code Section 1102.17 and Code of Civil Procedure Section 731a
- California Civil Code Sections 1103.4
- California Civil Code Section 1353

Under state law, real estate disclosure statements must use the following language.³

NOTICE OF AIRPORT IN VICINITY

This property is presently located in the vicinity of an airport, within what is known as an airport influence area. For that reason, the property may be subject to some of the annoyances or inconveniences associated with proximity to airport operations (for example: noise, vibration, or odors). Individual sensitivities to those annoyances can vary from person to person. You may wish to consider what airport annoyances, if any, are associated with the property before you complete your purchase and determine whether they are acceptable to you.

E5.2.1 Handbook Guidance—Overflight Area Boundary

The *California Airport Land Use Planning Handbook* (the Handbook), prepared by the California Department of Transportation (Caltrans) Division of Aeronautics, advises airport land use commissions (ALUCs) to identify where overflight concerns are likely to occur. It notes that “many people are sensitive to the frequent presence of aircraft overhead even at low noise levels. These reactions can mostly be expressed in the form of annoyance.”⁴ The Handbook advises ALUCs to promote land use compatibility in those areas, if possible, and buyer awareness measures to inform potential real estate buyers of the presence of aircraft overflights.⁵ The Handbook provides guidance for defining overflight areas. “Overflight boundaries often are established by an amalgamation of various data inputs, including noise contours, flight tracks, and even noise complaint patterns.”⁶ The Handbook suggests that

³ California Civil Code §1353

⁴ California Department of Transportation, Division of Aeronautics, *California Airport Land Use Planning Handbook*, October 2011, p. 3-8.

⁵ California Department of Transportation, Division of Aeronautics, *California Airport Land Use Planning Handbook*, October 2011, p. 3-9 – 3-10.

⁶ California Department of Transportation, Division of Aeronautics, *California Airport Land Use Planning Handbook*, October 2011, p. 3-10.

other indicators of frequent aircraft overflights are traffic pattern routes, traffic pattern entry corridors, and instrument approach and departure routes.⁷

E5.2.2 Handbook Guidance—Overflight Area Policies

The Handbook explains that the most effective mechanism for addressing overflight annoyance is “to avoid establishment of noise-sensitive land uses in the portions of airport environs that are exposed to significant levels of aircraft noise”.⁸ The Handbook discusses three suggested overflight compatibility strategies:

- Promotion of the least noise-sensitive kinds of development
- Acoustical treatment of the most highly noise-sensitive land uses
- Buyer awareness measures

Given the large area over which overflight concerns often exist, only the last of these measures is practical in the vicinity of most airports. Regulation of noise-sensitive land uses and requirements for acoustical treatment are most commonly applied within CNEL noise contours representing areas of significant noise exposure and are difficult to justify within a larger overflight area subject to lower noise levels.

The Handbook suggests that techniques to promote awareness of the potential for frequent aircraft overflight can be effective in preventing highly sensitive individuals from purchasing or renting property in overflight areas.⁹ ALUCs have no authority over real estate transactions and cannot require “real estate disclosure” as that term is typically defined and understood. The role of the ALUC in real estate disclosure is limited to its authority to establish the AIA, within which the disclosure provisions of state law apply. The Handbook recommends that the ALUC alert real estate agents active in the affected area of the extent of the AIA.¹⁰ The Handbook also suggests that ALUCs consider the use of recorded deed notices to promote disclosure of airport-related overflight impacts.

E5.2.3 Real Estate Disclosure vs. Overflight Notification

In this Airport Land Use Compatibility Plan (ALUCP), the term “real estate disclosure” refers to state law that requires sellers of new and existing residential properties, within an AIA, to notify buyers of potentially adverse effects from airport activity.¹¹

“Overflight notification” refers to the policies in this ALUCP that apply only to **new** residential development. Notification must occur within a defined overflight area boundary. Overflight notification policies are based on the Handbook guidance.

⁷ California Department of Transportation, Division of Aeronautics, *California Airport Land Use Planning Handbook*, October 2011, p. 3-111.

⁸ California Department of Transportation, Division of Aeronautics, *California Airport Land Use Planning Handbook*, October 2011, p.H-15.

⁹ California Department of Transportation, Division of Aeronautics, *California Airport Land Use Planning Handbook*, October 2011, p.4-13.

¹⁰ California Department of Transportation, Division of Aeronautics, *California Airport Land Use Planning Handbook*, October 2011, p. 4-14.

¹¹ California Department of Transportation, Division of Aeronautics, *California Airport Land Use Planning Handbook*, October 2011, p. 4-14.

E5.2.4 Recorded Deed Notices

Deed notices (referred to as overflight notifications in the Urban ALUCPs) are official statements recorded with a property deed. They note the presence of aircraft overflights above the property and describe the potential effects of the overflights. Since deed notices are part of the official property record, they would appear in a title report prepared for buyers at the time of closing on a property sale. Deed notices can be required by a local government at the time of development permit approval. Deed notices can be written to note the presence of the property in an area subject to frequent aircraft overflights.

Deed notices have limited effectiveness as disclosure tools. Deed notices are likely to be brought to a buyer's attention only after the buyer has committed to buy the property, at which time the buyer can withdraw from the purchase only at substantial cost and inconvenience. An additional drawback is that recorders in some counties may not record them because they do not affect the title to the property. According to the Handbook, the state Department of Real Estate has advised that this obstacle can be overcome if the county board of supervisors adopts an ordinance requiring the recordation of deed notices.¹²

E5.3 Technical Analysis

The overflight boundary for the San Diego International Airport (SDIA or the Airport) defines the area containing low altitude aircraft activity. The boundary combines the following:

- Areas exposed to frequent overflights
- Areas where noise complaints have been filed over the past several years
- Areas beneath Title 14, Code of Federal Regulations (CFR) Part 77 (Part 77) and U.S. Standard for Terminal Instrument Procedures (TERPS) airspace approach surfaces

Each of these considerations is an indicator either of areas subject to low altitude overflight or areas where people have registered concerns about noise or overflights. The areas of frequent overflight and low altitude airspace protection are expected to remain essentially the same over the 20-year ALUCP planning period. Aircraft flight patterns, including instrument approach and departure routes, will remain substantially the same because of the constraints imposed by the terrain and airspace and flight procedure design criteria. Based on the 20-year aviation activity forecast, presented in detail in **Appendix E1**, the types of aircraft operating at SDIA are projected to remain similar to those operating today.

Low altitude flight tracks, noise complaint locations and airspace protection areas are discussed in the following sections. **Exhibit E5-1** depicts the overflight indicators, i.e., density plots of overflights at altitudes lower than 3,000 feet mean sea level (MSL), noise complaint locations and the outer boundaries of Part 77 and TERPS surfaces at SDIA [\(see section E5.3.2](#)

¹² California Department of Transportation, Division of Aeronautics, *California Airport Land Use Planning Handbook*, October 2011, p. 4-14.

[for details on the noise complaints](#)). **Exhibit E5-2** depicts the individual radar flight tracks for multi-engine propeller departures along with the three overflight indicators.

E5.3.1 Low Altitude Flight Tracks

Areas subject to frequent low-altitude overflights can be accurately mapped using data from the SDIA Airport Noise and Operations Monitoring System (ANOMS). Topography has an important influence on the selection of a flight track altitude threshold. Terrain elevations around SDIA range from sea level to 2,500 feet MSL at San Miguel Mountain, approximately 14 miles east of SDIA near the extended centerline of Runway 27. Most of the inhabited areas in San Diego are at elevations of approximately 1,000 feet MSL or less.

To aid in the definition of an overflight area boundary, different forms of flight track analysis were undertaken. The first considered the location of individual aircraft overflights; the second considered the density of flight tracks in the study area over an extended period of time.

Flight tracks related to jet and multi-engine propeller approaches and departures were analyzed over a one-year period from June 1, 2010 to May 31, 2011. In one year, the combination of individual jet and propeller flight tracks essentially covered the entire SDIA ALUCP study area. Thus, it was necessary to look more closely at the most typical characteristics of aircraft flight patterns at SDIA. This was accomplished through a flight track density analysis. The number of overflights above a network of grid cells throughout the study area was calculated. The resulting flight track density was mapped, indicating areas overflowed an average of less than one time per day to over 200 per day. The flight track density pattern for overflights at altitudes of 3,000 feet MSL or less is depicted in **Exhibit E5-2**.

Because SDIA operates predominantly in a west flow configuration, with arrivals from the east and departures to the west on Runway 27, the overwhelming share of approaches are from the east and departures are to the west. Three other key points are:

1. Overflights by both jets and propeller aircraft are heavily concentrated over specific areas, reflecting the pattern of instrument departure and approach procedures.
2. Many propeller aircraft make departure turns sooner and make wider turns than jets. Similarly, many propeller aircraft make shorter arrivals than jet aircraft. This is consistent with established air traffic control procedures. During busy departure periods, propeller aircraft are directed to make wide turns to separate them from faster jets that are awaiting takeoff behind them.
3. At any given time, flights can occur virtually anywhere in the study area.

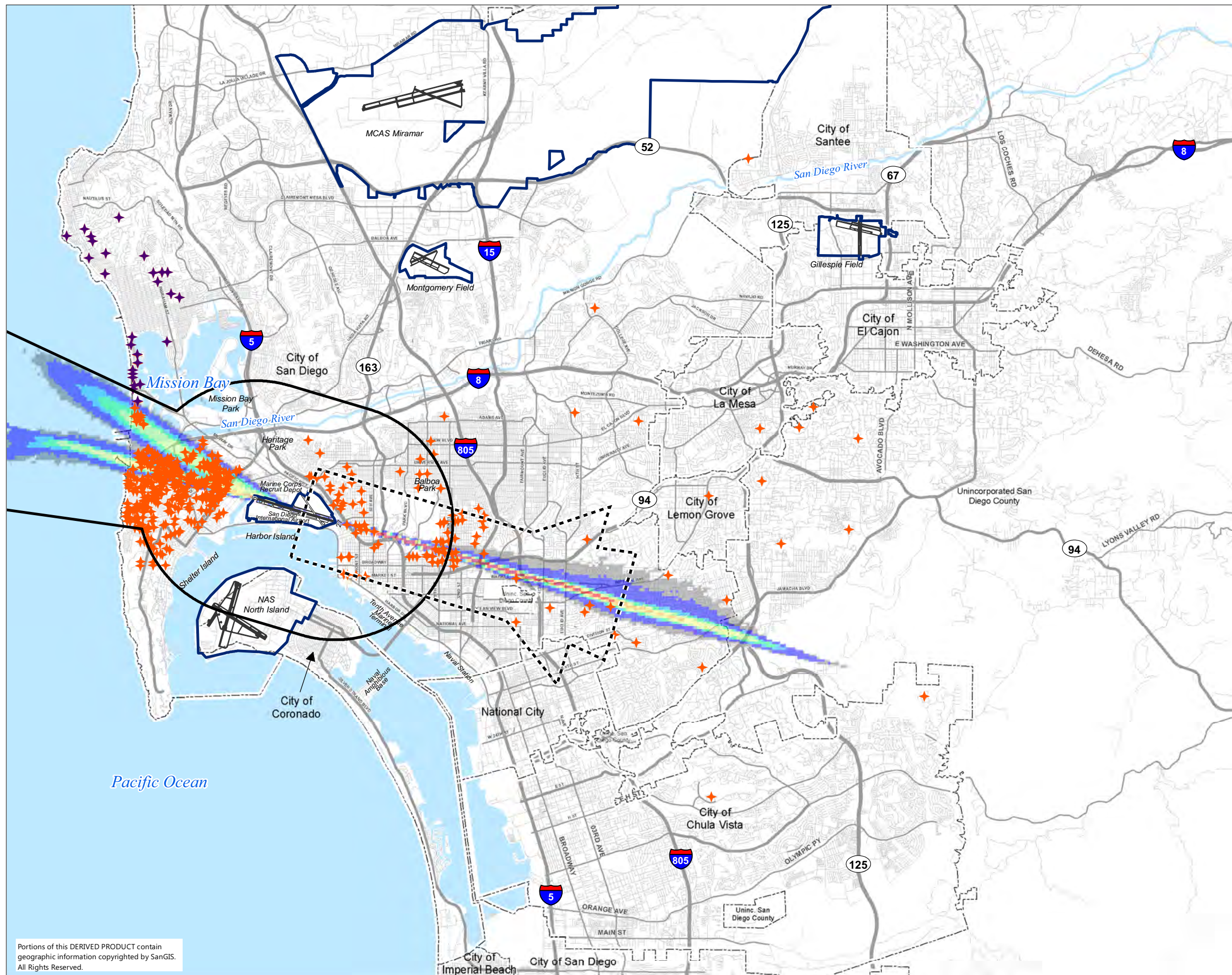

LEGEND

- Major Roads
- Highways
- - - Municipal Boundaries
- ▭ Airport Property Boundary
- · - · - Outer Boundary of Runway 27 TERPS Approach Surfaces
- ▭ Outer Boundary of Part 77 Surfaces
- ★ Location of Noise Complaints (2004-2009)²

Average Daily Operations Below 3,000 Feet MSL

■ <1	■ 50-100
■ 1-5	■ 100-150
■ 5-10	■ 150-200
■ 10-20	■ >200
■ 20-50	



Note: 1. MSL = Mean Sea level.
 2. The locations of noise complaints shown with a purple symbol depict locations in La Jolla, Pacific Beach and the northern part of Mission Beach.

Sources: San Diego Geographic Information Source (SanGIS), 2008 and 2011 (municipal boundaries, roads and highways); San Diego County Regional Airport Authority, Airport Noise Mitigation Department, August 2011 (average daily operations below 3,000 feet MSL and location of noise complaints); Ricondo & Associates, Inc., March 2011, based on FAA Federal Aviation Regulations, Part 77, Objects Affecting Navigable Airspace (Part 77 Subpart B outer boundary), and Federal Aviation Administration Order 8260.3B, United States Standards for Terminal Instrument Procedures, (Runway 27 TERPS approach surfaces outer boundary).

Prepared by: Ricondo & Associates, Inc., December 2013.

**Exhibit E5-1
 Overflight Indicators**

Portions of this DERIVED PRODUCT contain geographic information copyrighted by SanGIS. All Rights Reserved.

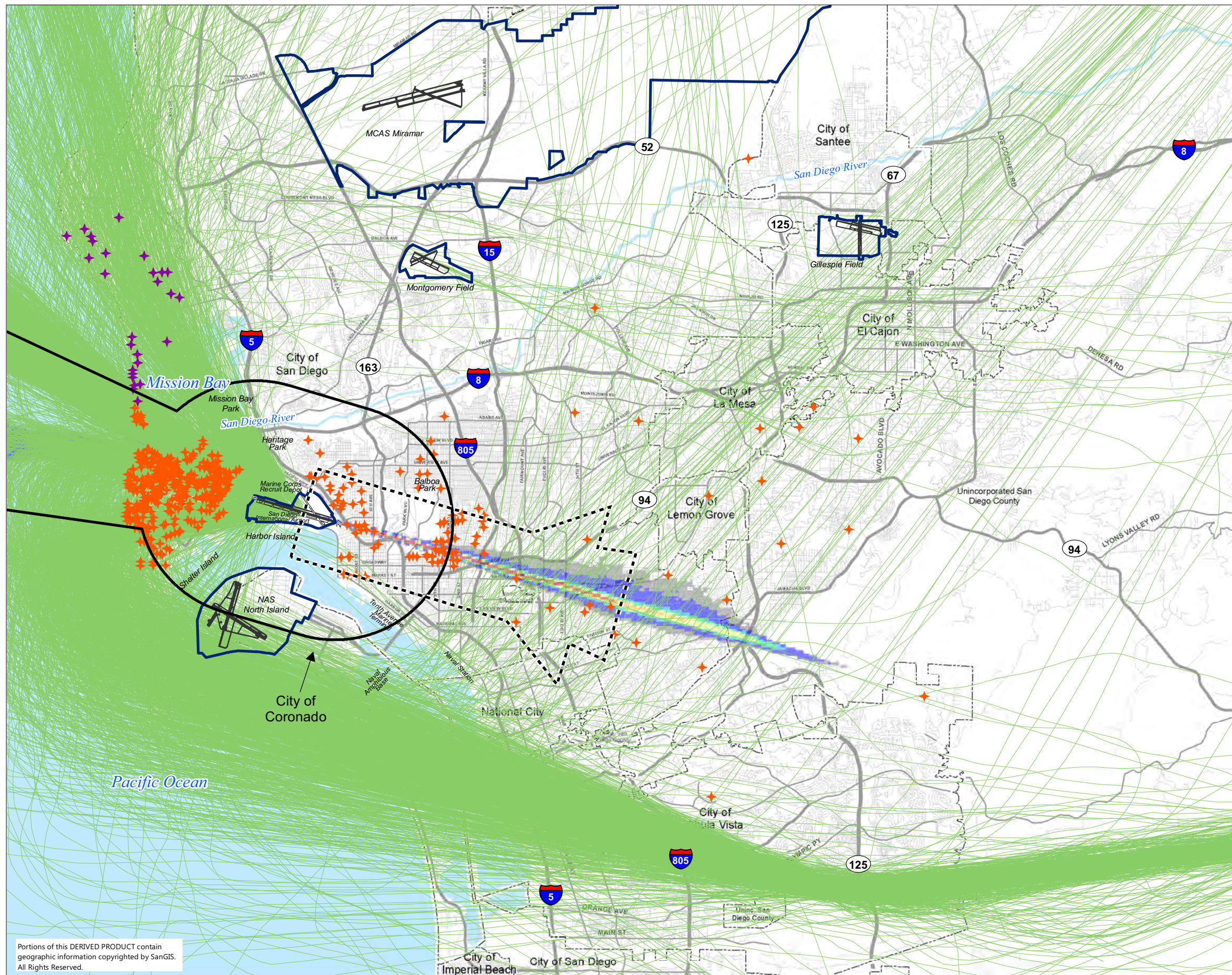

LEGEND

- Major Roads
- Highways
- - - Municipal Boundaries
- ▭ Airport Property Boundary
- - - Outer Boundary of Runway 27 TERPS Approach Surfaces
- ▭ Outer Boundary of Part 77 Surfaces
- ★ Location of Noise Complaints (2004-2009)³
- Multi-Engine Propeller Departures

Average Daily Operations Below 3,000 Feet MSL

Grey	<1	Yellow	50-100
Blue	1-5	Orange	100-150
Light Blue	5-10	Red	150-200
Green	10-20	Dark Red	>200
Light Green	20-50		

↑ north
 0 12,000 ft.

Notes:

1. MSL = Mean Sea level.
2. Flight tracks represent aircraft operations on Runway 27 from June 1, 2010 through May 31, 2011, during which a total of 185,090 operations were recorded.
3. The locations of noise complaints shown with a purple symbol depict locations in La Jolla, Pacific Beach and the northern part of Mission Beach.

Sources: San Diego Geographic Information Source (SanGIS), 2008 and 2011 (municipal boundaries, roads and highways); San Diego County Regional Airport Authority, Airport Noise Mitigation Department, July 2011 (flight tracks from Airport Noise and Operations Monitoring System, average daily operations below 3,000 feet MSL and location of noise complaints); Ricondo & Associates, Inc., March 2011, based on FAA Federal Aviation Regulations, Part 77, Objects Affecting Navigable Airspace, Part 77 Objects Affecting Navigable Airspace (Part 77 Subpart B outer boundary); Federal Aviation Administration Order 8260.3B, United States Standards for Terminal Instrument Procedures (Runway 27 TERPS approach surfaces outer boundary)

Prepared by: Ricondo & Associates, Inc., December 2013.

Exhibit E5-2
Overflight Indicators
and Radar Flight Tracks

Portions of this DERIVED PRODUCT contain geographic information copyrighted by SanGIS. All Rights Reserved.

E5.3.2 Noise Complaint Locations

While complaints are not a precise indicator of serious overflight problems that can be objectively measured and evaluated, the overall geographic pattern of noise complaints can be helpful in defining the boundaries of an area where overflight notification is warranted. In urbanized areas, it is common for complaints to be filed by people residing in areas outside the CNEL contours that define the area of significant noise impact (usually the 60 or 65 dB CNEL contour).¹³

Noise complaint locations for the six-year period from 2004 through 2009 were mapped for this analysis, as indicated in **Exhibits E5-1** and **E5-2**. All mapped locations are associated with complaints about noise or overflights from aircraft operating at SDIA. The densest pattern of complaints is west of the Airport in the Point Loma area, the area over which most departures occur. Complaints also extend north of Point Loma and up ~~toward La Jolla~~ into south Mission Beach. The individual radar flight tracks for propeller aircraft departures indicate a number of aircraft departing on Runway 27, turning right and flying over this area. These flights may be the cause of at least some of the noise complaints in this area. East of the Airport, the complaint pattern is widely scattered, although there is a clustering of complaints near the extended runway centerline.

Following circulation of the proposed ALUCP in July 2013, the proposed overflight area was modified to exclude the communities of La Jolla, Pacific Beach and the northern part of Mission Beach. The change in the delineation of the overflight area was based on a review of the recent noise complaint records (2010-2012) undertaken after receiving comments on the Draft EIR. Based on that review, the SDIA Noise Office found that most of the noise complaints recorded in the La Jolla, Pacific Beach and the north part of Mission Beach areas were filed several years ago. Few complaints have been registered recently, with only one north of Mission Beach since April 2012.

E5.3.3 Airspace Protection Areas

Part 77 airspace boundaries are helpful in defining an overflight zone.¹⁴ These surfaces are defined to protect the airspace within which low altitude overflights can be expected. TERPS approach surfaces also define areas of low altitude airspace. Refer to **Appendix E4** of this ALUCP for a detailed analysis of Part 77 and TERPS approach surfaces. Overflights occur almost everywhere within these airspace boundaries. Because these airspace boundaries are defined close to the Airport, overflights within the area are almost always at low altitudes. Based on conventional operating procedures and typical performance characteristics, aircraft making approach or departure turns within this area tend to be at altitudes between approximately 500 feet and 1,200 feet above the ground.

¹³ Partnership for Air Transportation Noise and Emissions Reduction (PARTNER), REPORT NO. PARTNER COE-2008-001, *Land Use Management and Airport Controls*, December 2007.

¹⁴ California Department of Transportation, Division of Aeronautics, *California Airport Land Use Planning Handbook*, October 2011, p. L-10.

E5.3.4 Proposed Overflight Boundary

Exhibit E5-3 depicts the proposed overflight area boundary for SDIA. The proposed overflight area boundary has been delineated to encompass the following areas:

- Areas exposed to frequent overflights at altitudes less than 3,000 feet above MSL
- Areas where noise complaints have been filed over the past several years
- Areas beneath Part 77 airspace and TERPS approach surfaces

E5.4 Overflight Policy Considerations

The main objective of overflight policies is to notify people about the presence of aircraft overflights near airports in order for them to make informed decisions regarding purchase or lease of real estate property in the affected areas. Therefore, public awareness is the policy alternative of choice for addressing public annoyance specifically due to overflight.

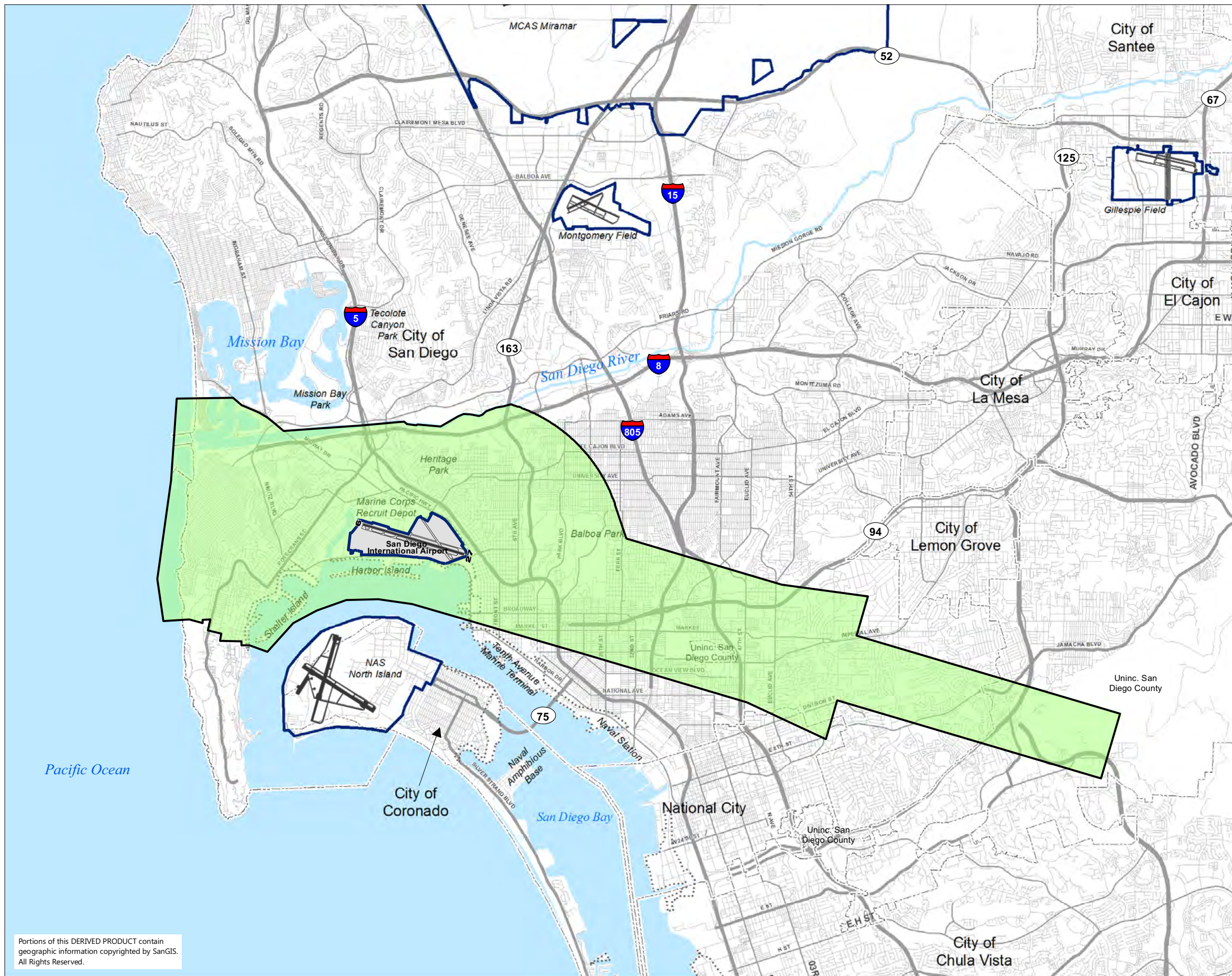

LEGEND

- Major Roads
- Highways
- - - Municipal Boundaries
- ▭ Airport Property Boundary
- ⋯ San Diego Unified Port District Planning Jurisdiction Boundary
- ▭ Proposed Overflight Area Boundary



Sources: San Diego Geographic Information Source (SanGIS), 2008 and 2011 (municipal boundaries, roads and highways); Ricondo & Associates, Inc., January 2012 (overflight area boundary).

Prepared by: Ricondo & Associates, Inc., October 2013.

Exhibit E5-3
Proposed Overflight Area Boundary

Portions of this DERIVED PRODUCT contain geographic information copyrighted by SanGIS. All Rights Reserved.



APPENDIX F

*Correspondence with the
Division of Aeronautics*

DEPARTMENT OF TRANSPORTATION

DIVISION OF AERONAUTICS – M.S.#40

1120 N STREET

P. O. BOX 942874

SACRAMENTO, CA 94274-0001

PHONE (916) 654-4959

FAX (916) 653-9531

TTY 711

*Flex your power!
Be energy efficient!*

March 18, 2011

Mr. Keith Wilschetz
Director of Planning
San Diego County Regional Airport Authority
P.O. Box 82776
San Diego, California 92138-2776

Dear Mr. Wilschetz:

The California Public Utilities Code (PUC) Section 21675 (a) requires that airport land use compatibility plans (ALUCP) be based on adopted airport master plans. When no airport master plan exists, or is not current, the ALUCP should be based on a current airport layout plan (ALP). It is not necessary that a formal ALP be drawn, and a more simplified diagram of the airport may be used for planning purposes. The only components essential to show are ones which may have off-airport compatibility implications—specifically: runways, runway protection zones, and airport property lines.

The Division of Aeronautics (Division) received and reviewed your March 1, 2011 letter and enclosures. This letter from your office is a re-submittal with some changes to the noise contours. These changes were made to account for some inaccuracies being caused by a hill. The Division has reviewed and supports the ALP to be used for the purpose of updating an ALUCP for the San Diego International Airport.

Our recommendation remains in effect until such time as any of the following occur: 1) a new airport master plan is adopted; or 2) there are significant changes in the existing airport conditions or the proprietor's expansion plans change over the next 20 years in such a manner as to have off-airport land use consequences.

The proposed runway displaced threshold will require a Corrected State Airport Permit. Detailed information regarding Corrected State Airport Permits can be viewed on-line at the following website: <http://www.dot.ca.gov/hq/planning/aeronaut/airport.html>. The applicant should also be advised to contact the Division's Aviation Safety Officer for San Diego County, John Favors, at (916) 654-5450, to request a State Amended/Corrected Airport Permit-Application package.

We look forward to continuing to work with the San Diego Regional Airport Authority in connection with approval of this important ALUCP. Please let us know if we can be of any additional assistance regarding this matter.

Sincerely,

A handwritten signature in blue ink that reads "Ron Bolyard".

RON BOLYARD
Aviation Planner



March 1, 2011

Mr. Terry Barrie
Senior Transportation Planner
California Department of Transportation
Division of Aeronautics, MS 40
P. O. Box 942874
Sacramento, CA 94274-0001

RE: San Diego International Airport Land Use Compatibility Plan

Dear Mr. Barrie:

California Public Utilities Code Section 21675(a) requires an airport land use compatibility plan (ALUCP) to be based upon a long-range airport master plan or an airport layout plan (ALP), with the approval of the California Department of Transportation, Division of Aeronautics. By this letter, and consistent with the requirements of Section 21675(a), the San Diego County Regional Airport Authority (SDCRAA), acting in its capacity as the Airport Land Use Commission (ALUC) for San Diego County, is seeking written acceptance by the California Division of Aeronautics (CDA) of the enclosed ALP and related airport forecasts for use by the SDCRAA ALUC in connection with its compatibility planning and preparation of the updated ALUCP for San Diego International Airport (SDIA).

Enclosed is information that will facilitate your review of the ALP for SDIA and will provide you with the information necessary to approve the use of the enclosed ALP and related airport forecasts as the basis for the preparation of the ALUCP for this airport.

We are in the process of preparing the ALUCP. SDCRAA held its first public information workshop on the ALUCP project on January 25, 2011 and will hold its first Steering Committee meeting on February 23, 2011. Thus, your early attention to this request would be appreciated. The estimated timeframe for releasing the draft ALUCP and the related California Environmental Quality Act (CEQA) documentation for public review is mid-2012.

Please address your response to Mr. Keith Wilschetz with the San Diego County Regional Airport Authority, whose address is provided below, and copy me.

Keith Wilschetz
Director of Planning
San Diego County Regional Airport Authority
P.O. Box 82776
San Diego, CA 92138-2776



Mr. Terry Barrie
California Department of Transportation
March 1, 2011
Page 2

If you have any questions regarding the enclosed information or would like to discuss any of the materials further, please call me at (760) 444-0106 Ext. 399 or Amy Gonzalez at 619-400-2425 (Director, Counsel Services for the SDCRAA), at your convenience. Thank you for your assistance.

Sincerely,
RICONDO & ASSOCIATES, INC.

Mark R. Johnson, AICP
Director

Enclosures:

Attachment A: Airport Background Data Summary
Exhibit 1: Airport Layout Plan (conditionally approved by FAA, July 10, 2009)
Exhibit 2: 2030 Forecast Noise Exposure
Exhibit 5-5.1: 2030 Forecast Noise Exposure – With and Without Hill Effects
Appendix G: Supplemental Noise Measurement Program to Determine Hill Effects (from Draft Noise Compatibility Program, San Diego International Airport, January 2010)
Appendix H: FAA Response to SDCRAA on Nonstandard Adjustments to the INM Modeling Process (from Draft Noise Compatibility Program, San Diego International Airport, January 2010)

cc: Mr. Keith Wilschetz, Director of Planning, SDCRAA (with enclosures)
Ms. Amy Gonzalez, Director, Counsel Services, SDCRAA (with enclosures)
Ms. Angela Jamison, Planning Manager, SDCRAA (with enclosures)
Ms. Kim Sheredy, Airport Planner, SDCRAA (with enclosures)
Ms. Lori Ballance, Gatzke Dillon & Ballance, LLP (with enclosures)

10-14-0696-03-1150
Read File

Attachment A: Airport Background Data

Introduction

San Diego International Airport (SDIA) has the distinction of being the nation's busiest single-runway commercial airport. In 2009, SDIA provided service to 16.9 million passengers. SDIA operations are managed by the San Diego County Regional Airport Authority (SDCRAA), which was formed in 2002 and assumed control of SDIA from the San Diego Unified Port District in 2003.

California Public Utilities Code Section 21675(a) states, "[t]he commission's airport land use compatibility plan shall include and shall be based on a long-range master plan or an airport layout plan, as determined by the Division of Aeronautics of the Department of Transportation, that reflects the anticipated growth of the airport during at least the next 20 years." This guidance is echoed in the California Airport Land Use Planning Handbook (the "Handbook"). The Handbook recommends that an airport layout plan (ALP) be used as a basis for an Airport Land Use Compatibility Plan (ALUCP) if no adopted master plan exists or if the adopted master plan is not current.

The current SDIA Master Plan was adopted in May 2008. As part of the Master Plan studies, an activity forecast was developed and finalized in June 2004. Since then, however, SDCRAA has prepared a more recent comprehensive activity forecast as part of the Destination Lindbergh Study, which is also being used for the ongoing development of the Regional Aviation Strategic Plan.¹ This forecast was developed based on 2007 activity at SDIA and provided forecasted enplanements, operations, and cargo tonnage through 2030. As SDCRAA's most recent forecast, which is being used for ongoing airport planning studies, SDCRAA intends to use the Destination Lindbergh Study forecast for the updated SDIA ALUCP.

Additionally, since the adoption of the Master Plan in May 2008, an ALP was completed in June 2009 and approved by the Federal Aviation Administration (FAA) in July 2009, subject to selected conditions. The following sections provide detailed information regarding airport policies, the airfield system, and existing and future forecasted airport activity.

Airport Policies

Originally adopted in February 1992 by the San Diego Association of Governments, the existing ALUCP for SDIA was amended in October 2004 by SDCRAA. The original ALUCP was based upon planning assumptions derived from both the San Diego International Airport Lindbergh Field Development Study and the San Diego International Airport Lindbergh Field Part 150 Program. SDCRAA is currently in the process of updating the ALUCP for SDIA.

Airport Description

As indicated in **Table 1** below, SDIA has a single, 9,401-foot long runway which is oriented east-west. Displaced thresholds are required on each end of Runway 9-27 due to terrain and obstructions east and west of the airport. The Runway 9 threshold is displaced by 700 feet and Runway 27 threshold is displaced by 1,810 feet.

¹SDCRAA initiated the Destination Lindbergh study in March 2008 as a special follow-up study to the Airport Master Plan. The objective was to determine the ultimate configuration and capacity of SDIA as well as improve intermodal transportation connectivity between the Airport and the greater San Diego region. The Regional Aviation System Plan focuses on the roles of the various airports in the region, including future activity at each airport and general facility requirements.

The taxiway system provides access between Runway 9-27 and the terminal areas, various aircraft parking areas, cargo areas, and other airfield facilities. The primary taxiways on the airfield are Taxiways B and C. Taxiway B parallels the full length of the runway to the south and connects Runway 9-27 with the passenger terminal apron and other facilities located south of the runway. Taxiway C parallels the runway to the north between Taxiway C6 and the east end of the runway and provides access to the remaining overnight (RON) apron and SDIA's general aviation (GA) facility.

Currently, the passenger terminal complex consists of 45 active gates (41 contact gates and 4 commuter gates) in three separate terminals: Terminal 1, Terminal 2, and the Commuter Terminal. Terminal 1, formerly known as the East Terminal, is the oldest terminal at SDIA. It encompasses approximately 257,500 square feet and provides 19 gates. Terminal 1 serves the most passengers of the three terminals at SDIA. Terminal 2, located west of Terminal 1, is comprised of Terminal 2 East and Terminal 2 West. Terminal 2 East consists of approximately 225,700 square feet and provides 13 gates, while Terminal 2 West consists of approximately 326,600 square feet with 9 gates. Formerly an aircraft maintenance hangar, the Commuter Terminal is now a mixed-used terminal building providing 4 gates and 133,000 square feet of space on three levels. SDCRAA administrative offices occupy the second and third floors of the building.

At each terminal, the inner curb is primarily used by private vehicles for passenger loading and unloading, as well as taxi and limousine passenger drop-off. Buses and parking shuttles also have designated curb space for passenger loading and unloading.

SDCRAA operates the terminal area automobile parking (short-term parking), remote public parking (long-term parking), and employee parking lots. Privately-operated remote parking facilities are also available. SDCRAA also maintains parking spaces in a cell phone lot that allows drivers to remain in their vehicles for a maximum of one hour while waiting for arriving passengers.

The current ALP was conditionally approved by the FAA on July 10, 2009 (see attached **Exhibit 1**). Consistent with the 2008 Master Plan, the ALP depicts proposed facilities on the south side of the airport including a second-level roadway and the expansion of Terminal 2 West. On the north side of the airport, the proposed general aviation facilities and other improvements are also depicted in the ALP.

Existing Airport Activity

Today SDIA's primary services include commercial passenger carriers, cargo operations and general aviation operations. As of November 2010, commercial passenger services were provided by 18 passenger airlines operating in and out of SDIA. Cargo carriers operating at SDIA included Capital International Cargo, FedEx, UPS, and ABX. The bulk of general aviation operations occurring at SDIA are corporate jet services. In 2009, SDIA accommodated 199,209 total operations, 16,974,172 passengers, and the shipment of 121,538 tons of cargo and U.S. mail.

Airport Use Regulations (AURs) establish restrictions on operations at SDIA by certain types of aircraft, and prohibit departures by any aircraft between 11:30 p.m. and 6:30 a.m., except in emergencies or for flights of military necessity. Additionally, in accordance with Resolution No. 2006-0040, non-Stage 3 aircraft are prohibited from operating between 10:00 p.m. and 6:30 a.m. Arrivals by aircraft of all types are permitted 24 hours a day.

The Instrument Landing System (ILS) approach to Runway 9 is the only precision approach procedure at SDIA. Area Navigation (RNAV) GPS and localizer approaches are available to both Runway 9 and Runway 27. SDIA functions in a west flow operating configuration approximately 97 percent of the time with east flow operations making up the remaining three percent. **Table 2** below provides information on runway use for calendar year 2007 based on data used for the development

of noise exposure maps under the Part 150 Update efforts. If visibility is greater than two miles and cloud ceilings are greater than 700 feet, Runway 27 is used for arrivals and departures. If the cloud ceiling is less than 700 feet and visibility is less than two miles, Runway 9 is used for both arrivals and departures; however, air carrier pilots frequently request to use Runway 27 for departures in these conditions because the Runway 9 departure climb gradient would force them to accept weight penalties.

Future Airport Activity

The current SDIA Master Plan was adopted in May 2008. As part of the Master Plan studies, an activity forecast was developed and finalized in June 2004, using 2002 as a baseline year and presenting forecasted operations and passenger activity through 2030. Since then, however, SDCRAA has prepared a more recent comprehensive activity forecast as part of the Destination Lindbergh Study, which is being used in the development of the Regional Aviation Strategic Plan (RASP).

The forecast developed for the Destination Lindbergh Study was based on 2007 flight data and provided forecasted enplanements, operations, and cargo tonnage through 2030. The Destination Lindbergh Study forecast was developed through extensive technical, economic and statistical analyses, and contained both unconstrained and constrained forecast scenarios. The unconstrained forecast represented market-driven demand for air service, and indicates the level of activity that SDIA could expect if it had no physical or operational constraints. The constrained forecast indicated the amount of forecasted activity that could be supported subject to facility, operational, and environmental limitations that are inherent to SDIA.

Based on the constrained forecasts, enplanements are forecasted to grow at a compounded annual growth rate (CAGR) of 1.9 percent between 2007 and 2030, resulting in approximately 28.4 million passengers forecasted in 2030, compared with the current 16.9 million passengers recorded in 2009. Operations are forecasted to grow at a CAGR of 1.0 percent, reaching approximately 286,100 annual operations in 2030, compared with 199,209 operations recorded in 2009. Tonnage of cargo and U.S. mail is forecasted to grow at a CAGR of 1.7 percent, reaching approximately 225,600 tons in 2030 compared with 121,538 tons recorded in 2009.

For the purposes of land use compatibility planning for SDIA, and consistent with direction in the State Aeronautics Act and the Caltrans Handbook, SDCRAA intends to use the Destination Lindbergh Study constrained forecast for the updated SDIA ALUCP.

Forecast Airport Noise Exposure

Exhibit 2 (attached) depicts the forecasted 2030 CNEL noise exposure contours at SDIA, ranging from 60 dB CNEL to 75 dB CNEL, which SDCRAA intends to use for its updated ALUCP for SDIA. The forecasted 2030 CNEL noise exposure contours are based on the Destination Lindbergh constrained activity forecasts, described above. **Tables 3 and 4** provide information on forecasted annual operations at SDIA by Integrated Noise Model (INM) aircraft type, time of day and runway assignments.

The CNEL noise contours for the ALUCP were developed using version 7.0a of the INM. With the exception of the forecast operations and fleet mix, which were adjusted to reflect 2030 forecast conditions, the INM input assumptions used to develop the proposed ALUCP noise contours depicted in **Exhibit 2** were the same as those used for most recent update of SDIA's Federal Aviation

Regulation Part 150 Noise Exposure Maps (NEMs). The updated NEMs were accepted by the FAA on November 10, 2009.

For the ALUCP, one modification was made to the INM output file to reflect the terrain that surrounds SDIA; this unique terrain has an impact on the noise levels in the environs of SDIA. Specifically, field noise measurements indicate that the face of the hill north of the east end of Runway 9-27 is exposed to higher aircraft noise levels than indicated by the standard predictions of the INM. The higher measured noise levels in this area occur because the hill face is exposed directly to noise from the breakaway thrust of aircraft departing on Runway 27 without the benefit of over-the-ground attenuation, which is taken into account by the standard noise propagation algorithms in the INM. This special condition is referred to as the hill effect.

SDCRAA accounts for hill effects in its quarterly noise contour submittals to Caltrans in compliance with the terms of its noise variance under Title 21 of the California Code of Regulations, Section 5000, et seq. The quarterly noise reports are required to consider hill effects because they are predicated on actual noise measurements collected by noise monitors located in the SDIA environs.

Specifically, in accordance with Title 21, each quarter SDCRAA adjusts its modeled CNEL noise contours to accurately reflect the actual measured noise values at its noise monitoring stations on the hill behind the start of takeoff to determine the extent of the 65 dBCNEL contour. A 3 to 5 dB difference in measured noise values at the noise monitors versus the measured INM modeled noise values (based upon the standard output values without taking into account the "hill effect") has occurred consistently at the face of the hill north of the east end of Runway 9-27. The noise monitors have been calibrated to accurately measure actual aircraft noise at these locations.

In light of the differences between the modeled noise values and the values measured at the noise monitors that take into account the "hill effects", SDCRAA prepared a supplemental noise program in connection with the Part 150 Study to examine the effects on noise levels caused by the rising terrain behind the start of takeoff Runway 27. The supplemental noise program was prepared in order to: (1) determine whether the hill effect exists and to what extent the hill effects require modification to the CNEL noise contours in this area; (2) determine a repeatable and defensible process to accurately modify the CNEL contours in this area to account for the hill effects; and (3) obtain FAA approval of the process and the resulting CNEL contours. The supplemental noise program that was prepared in connection with the Part 150 Study is enclosed for your information. (See Appendix G from the Draft Part 150 Noise Compatibility Program (NCP).)

In connection with the Part 150 Study process, SDCRAA provided the FAA with the supplemental noise program and the CNEL noise contours reflecting both CNEL noise contours with and without the hill effects. Because of the strict policy guidance regarding Part 150 Studies, the FAA indicated that it could not accept the incorporation of the hill effects adjustments to the CNEL noise contours for the Part 150 NEMs (see enclosed Appendix H from the Draft Part 150 NCP). The FAA did, however, indicate to SDCRAA that it would consider accepting the hill effect adjustments for determining noise mitigation program eligibility as proposed in the updated SDIA Part 150 Noise Compatibility Program that it is currently reviewing for approval.

Notwithstanding the pending final approval of the Part 150 Study for SDIA, Caltrans has indicated that adjustments to the CNEL noise contour maps for SDIA should reflect the hill effects in order to

comply with Title 21 noise variance obligations; and that failing to take into consideration the hill effects may increase the perceived noise problem at SDIA in a manner that does not accurately reflect the actual noise impacts in the environs surrounding SDIA.

As indicated above, based on Caltrans' reliance on the CNEL noise contours that take into account the hill effects in the environs of SDIA in connection with the SDIA noise variance process, SDCRAA believes that hill effects should be incorporated into the CNEL noise contours used for the updated ALUCP for SDIA. Doing so provides the most accurate CNEL noise contours for the SDIA environs. This is critical in order to ensure that any noise policies approved in connection with the updated ALUCP for SDIA do not unnecessarily burden property that would not otherwise be required to comply with the noise policies based upon the actual projected noise levels in the environs of SDIA taking into account the "hill effects." The noise contours depicted in **Exhibit 2** reflect the hill effects adjustment. The enclosed Exhibit 5-5.1 illustrates the differences in the noise contours with and without the hill effects adjustment to facilitate your understanding of the importance of making the hill effects modifications to the CNEL noise contours at SDIA.

Table 1**SDIA - Airport Features Summary**

General Information	Description		
Airport Ownership	San Diego County Regional Airport Authority		
Year Opened as Public-Use Airport ¹	1928		
Property Size	661.5 acres		
Airport Classification ^{2/}	Commercial Service Airport (Primary)		
Airport Elevation ^{3/}	16.5 feet above mean sea level		
Passenger Terminals ^{4/}	Two terminals, approximately 809,800 s.f., 41 gates		
Commuter Passenger Terminal ^{4/}	Approximately 133,000 s.f., 4 gates		
Airport Reference Code ^{3/}	D-V		
Runway ^{3/}	Runway 9-27		
Runway Dimensions ^{3/}	9,401 feet long, 200 feet wide		
	700 foot displaced threshold for Runway 9		
	1,810 foot displaced threshold for Runway 27		
Pavement Strength ^{3/}	Single Wheel		
	100,000 pounds (Gross Aircraft Weight)		
	Dual Wheel		
	150,000 pounds (Gross Aircraft Weight)		
Dual-Tandem Wheel		250,000 pounds (Gross Aircraft Weight)	
Double Dual-Tandem Wheel		720,000 pounds (Gross Aircraft Weight)	
Effective Runway Gradient ³	0.02%		
Runway Lighting ^{3/}	High Intensity Runway (HIRL), Centerline (CL), and Touch-Down Zone (TDZ) lights		
Runway Protection Zones (RPZ) ^{3/}	Runway 9		
	1,000 feet inner width, 1,750 feet outer width, 2,500 feet long		
	Runway 27		
	1,000 feet inner width, 1,425 feet outer width, 1,700 feet long		
Approach Slopes ^{3/}	Runway 9		
	34:1 approach slope to displaced threshold		
	Runway 27		
	20:1 approach slope to displaced threshold		
Declared Distances ^{3/}	Runway 9	Runway 27	
	Takeoff Run Available (TORA)	9,401 feet	9,401 feet
	Takeoff Distance Available (TODA)	9,401 feet	9,401 feet
	Accelerate-Stop Distance Available (ASDA)	8,280 feet	9,401 feet
	Landing Distance Available (LDA)	7,580 ft. (existing) – 7,280 ft. (future)	7,591 feet

¹ San Diego County Regional Airport Authority, <http://www.san.org> (accessed October 2010).

² Federal Aviation Administration, National Plan of Integrated Airport Systems (2009-2013), Appendix B, page B-12, October 2008.

³ San Diego County Regional Airport Authority, *Airport Layout Plan*, June 26, 2009.

⁴ Jacobs Consultancy Team, *Destination Lindbergh Technical Report*, pages 2-17 to 2-22, March 2009.

Note: Pavement strength refers to main landing gear configuration.

Sources: As noted in footnotes 1 through 4 above.

Prepared by: Ricondo & Associates, Inc. November 2010.

Table 2**SDIA - Runway Utilization for Calendar Year 2007**

Runway	Runway Use					
	Arrivals			Departures		
	Day	Evening	Night	Day	Evening	Night
Runway 9	1.36%	1.24%	4.73%	0.94%	1.13%	0.86%
Runway 27	98.64%	98.76%	95.27%	99.06%	98.87%	99.14%
Total	100%	100%	100%	100%	100%	100%

Notes: Day = 7:00am to 7:00pm; Evening = 7:01pm to 10:00pm; Night = 10:01pm to 6:59am.
These runway use percentages were used in the 2030 forecast noise analysis for the ALUCP.

Source: HMMH, San Diego International Airport Part 150 Update, Noise Exposure Maps, Draft, page 54, March 2009.
Prepared by: Ricondo & Associates, Inc., November 2010.

Table 3

SDIA 2030 Forecast - Annual Operations by Aircraft Type and Time-of-Day

INM Aircraft Type	Aircraft Model	Number of Arrivals			Number of Departures		
		Day	Evening	Night	Day	Evening	Night
1900D	Beech 1900D	15	0	0	1	14	0
727EM2	Boeing 727-200 ¹	5	5	0	10	0	0
737300	Boeing 737-300	16,035	4,132	1,316	16,255	4,235	994
737400	Boeing 737-400	13	13	7	22	4	6
737700	Boeing 737-700	24,394	6,733	3,040	26,600	5,342	2,224
737800	Boeing 737-800	18,087	5,760	4,117	22,070	1,629	4,264
737N9	Boeing 737-200 ¹	0	0	1	1	0	0
74720B	Boeing 747-200	4	2	2	7	0	1
757PW	Boeing 757-200	542	4	4	535	11	4
757RR	Boeing 757-200	19	1	5	17	7	1
767300	Boeing 767-300	2,853	1,298	699	3,645	2,98	906
767CF6	Boeing 767-200	340	279	310	518	313	98
777300	Boeing 777-300	76	5	70	64	72	14
A300-622R	Airbus A300-622R	525	11	422	288	430	239
A310-304	Airbus A310-304	223	2	267	16	269	208
A319-131	Airbus A319-131	304	65	2	303	3	63
A320-211	Airbus A320-211	11,017	3,408	2,018	12,248	1,096	3,098
A320-232	Airbus A320-232	2,401	1,741	116	2,285	1,199	776
A321-232	Airbus A321-232	2,357	1,617	517	3,110	757	624
A330-301	Airbus A330-301	8	944	36	980	6	2
BAE146	BAe 146-200	2	0	0	2	0	0
BEC58P	Beech Baron 58P	158	10	8	138	22	15
CIT3	Cessna Citation 3	403	48	14	408	37	21
CL600	Challenger 600	408	36	16	407	32	21
CL601	Challenger 601	568	27	24	557	37	24
CNA172	Cessna 172R	164	28	22	144	32	38
CNA206	Cessna 206H	193	10	0	174	12	12
CNA20T	Cessna T206H	27	0	0	15	18	0
CNA441	Cessna Conquest II	52	5	1	51	5	2
CNA500	Cessna Citation 2	960	95	52	947	109	51
CNA55B	Cessna Citation 550 Bravo	33	0	0	19	3	11
CNA750	Cessna Citation X	636	72	33	654	51	36
DC93LW	DC9-30*	2	0	0	1	1	0
DHC6	DeHavilland Dash 6	325	35	14	275	72	28
EMB120	Embraer 120 ER	2,126	359	105	2,128	427	35
EMB145	Embraer 145 ER	2,700	543	251	2,764	384	345

Table 3 (2 of 2)**SDIA 2030 Forecast - Annual Operations by Aircraft Type and Time-of-Day**

INM Aircraft Type	Aircraft Model	Number of Arrivals			Number of Departures		
		Day	Evening	Night	Day	Evening	Night
FAL20	Dassault Falcon 20	27	0	0	24	2	1
FAL50	Dassault Falcon 50	79	12	7	91	6	1
FAL900	Dassault Falcon 900	98	14	2	106	5	4
GASEPF	GA Single-engine w/ Fixed Pitch Prop	1,363	26	24	1,238	32	143
GASEPV	GA Single-engine w/ Variable Pitch Prop	704	88	18	669	97	44
GII	Gulfstream GII	20	11	2	30	3	0
GIIB	Gulfstream GIIB	96	12	8	103	10	4
GIV	Gulfstream GIV	367	43	20	374	33	23
GV	Gulfstream GV	3,026	342	678	3,148	668	230
IA1125	Israel IAI-1125 Astra	574	77	27	596	48	34
J328	Fairchild/Dornier 3282	10	1	0	7	4	0
KC135R	KC-135R	0	0	1	1	0	0
L10115	Lockheed L1011-500	1	0	0	0	0	0
LEAR25	Lear 25	43	3	0	45	1	0
LEAR35	Lear 36	1,005	91	67	1,022	97	45
MD83	MD-83	0	4	5	0	1	8
MU3001	Mitsubishi Diamond	2,777	285	137	2,835	241	122
PA28	Piper Warrior	32	5	2	29	3	7
PA31	Piper Navajo Chieftain	13	2	0	15	0	0
SABR80	Sabreliner 80	3	0	0	3	0	0
SD330	Shorts SD330	91	8	2	88	9	5
SF340	Saab SF340	1,381	341	222	1,285	457	203
Total Operations		99,790	28,683	14,727	109,484	18,365	15,051
Percentages		34.90%	10.00%	5.20%	38.30%	6.40%	5.30%

Note: Totals may not sum as indicated due to rounding.

- 1/ Aircraft equipped with hush kits to comply with 14 CFR Part 36 Stage 3 noise standards.
2/ INM aircraft type custom-defined by HMMH and approved by FAA, November 20, 2008. See Draft San Diego International Airport Part 150 Update Noise Exposure Maps, Appendices, March 2009, Appendix E, p. E-3.

Source: Ricondo & Associates, Inc., August 2009 (operations by aircraft type and time-of-day distributions from constrained activity forecasts prepared for Destination Lindbergh Study (Landrum & Brown, Jacobs Consultancy Team, *Destination Lindbergh, Aviation Activity Forecast*, February 2009) and INM modeling parameters from Part 150 Study Update (HMMH, *San Diego International Airport Part 150 Update, Noise Exposure Maps*, August 2009).

Prepared by: Ricondo & Associates, Inc., November 2010.

Table 4 (1 of 2)

SDIA 2030 Forecast - Annual Operations by Aircraft Type and Runway

INM Aircraft Type	Aircraft Model	Number of Arrivals		Number of Departures		Totals
		Runway 9	Runway 27	Runway 9	Runway 27	
1900D	Beech 1900D	0	15	0	15	30
727EM2	Boeing 727-200 ¹	0	10	0	10	20
737300	Boeing 737-300	317	21,167	199	21,284	42,967
737400	Boeing 737-400	0	32	0	32	64
737700	Boeing 737-700	634	33,532	360	33,806	68,332
737800	Boeing 737-800	352	27,612	205	27,758	55,927
737N9	Boeing 737-200 ¹	0	1	0	1	2
74720B	Boeing 747-200	0	8	0	8	16
757PW	Boeing 757-200	14	535	6	544	1,099
757RR	Boeing 757-200	0	25	0	25	50
767300	Boeing 767-300	83	4,767	44	4,806	9,700
767CF6	Boeing 767-200	27	902	9	920	1,858
777300	Boeing 777-300	10	140	3	148	301
A300-622R	Airbus A300-622R	41	916	5	953	1,915
A310-304	Airbus A310-304	211	282	7	485	985
A319-131	Airbus A319-131	6	364	2	368	740
A320-211	Airbus A320-211	231	16,211	110	16,331	32,883
A320-232	Airbus A320-232	46	4,212	40	4,219	8,517
A321-232	Airbus A321-232	75	4,416	47	4,445	8,983
A330-301	Airbus A330-301	14	974	17	971	1,976
BAE146	BAe 146-200	0	2	0	2	4
BEC58P	Beech Baron 58P	13	163	8	168	352
CIT3	Cessna Citation 3	5	460	5	460	930
CL600	Challenger 600	2	457	3	456	918
CL601	Challenger 601	8	610	5	613	1,236
CNA172	Cessna 172R	19	195	28	186	428
CNA206	Cessna 206H	0	203	4	193	400
CNA20T	Cessna T206H	0	27	1	31	59
CNA441	Cessna Conquest II	2	56	4	55	117
CNA500	Cessna Citation 2	16	1,091	12	1,095	2,214
CNA55B	Cessna Citation 550 Bravo	0	33	1	32	66
CNA750	Cessna Citation X	9	732	3	738	1,482
DC93LW	DC9-30*	0	2	0	2	4
DHC6	DeHavilland Dash 6	5	370	5	370	750
DHC8	DeHavilland Dash 8	0	1	0	1	2

Table 4 (2 of 2)

SDIA 2030 Forecast - Annual Operations by Aircraft Type and Runway

INM Aircraft Type	Aircraft Model	Number of Arrivals		Number of Departures		Totals
		Runway 9	Runway 27	Runway 9	Runway 27	
EMB120	Embraer 120 ER	38	2,553	15	2,576	5,182
EMB145	Embraer 145 ER	44	3,449	30	3,463	6,986
FAL20	Dassault Falcon 20	0	27	1	25	53
FAL50	Dassault Falcon 50	1	97	1	97	196
FAL900	Dassault Falcon 900	0	115	1	114	230
GASEPF	GA Single-engine w/ Fixed Pitch Prop	154	1,259	114	1,299	2,826
GASEPV	GA Single-engine w/ Variable Pitch Prop	65	745	35	775	1,620
GII	Gulfstream GII	1	33	0	33	67
GIIB	Gulfstream GIIB	3	113	0	116	232
GIV	Gulfstream GIV	9	422	5	426	862
GV	Gulfstream GV	71	3,975	45	4,002	8,093
IA1125	Israel IAI-1125 Astra	16	661	7	670	1,354
J328	Fairchild/Dornier 328 ²	0	11	0	11	22
KC135R	KC-135R	0	1	0	1	2
L10115	Lockheed L1011-500	0	1	0	0	1
LEAR25	Lear 25	0	46	0	46	92
LEAR35	Lear 36	25	1,138	14	1,150	2,327
MD83	MD-83	1	8	2	7	18
MU3001	Mitsubishi Diamond	46	3,153	29	3,169	6,397
PA28	Piper Warrior	0	40	0	40	80
PA31	Piper Navajo Chieftain	0	15	0	15	30
SABR80	Sabreliner 80	0	3	0	3	6
SD330	Shorts SD330	1	100	2	100	203
SF340	Saab SF340	25	1,920	15	1,929	3,889
Totals		2,640	140,410	1,450	141,600	286,100
Percentages		0.90%	49.10%	0.50%	49.50%	100%

Note: Totals may not sum as indicated due to rounding.

Source: Ricondo & Associates, Inc., August 2009 (operations by aircraft type and time-of-day distributions from constrained activity forecasts prepared for Destination Lindbergh Study (Landrum & Brown, Jacobs Consultancy Team, Destination Lindbergh, Aviation Activity Forecast, February 2009) and INM modeling parameters from Part 150 Study Update (HMMH, San Diego International Airport Part 150 Update, Noise Exposure Maps, August 2009).

Prepared by: Ricondo & Associates, Inc., November 2010.

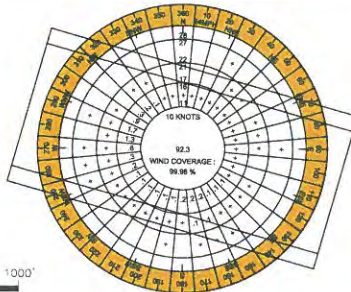
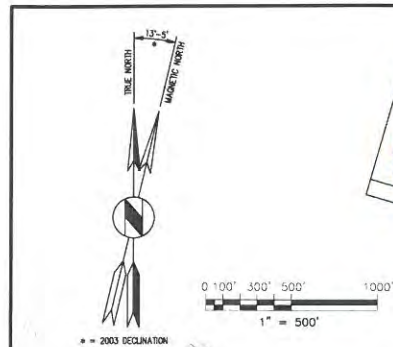

WIND ROSE
ALL WEATHER

PERCENT WIND COVERAGE TABLE

CROSSWIND COMPONENT	RUNWAY HEADING
0-5 KNOTS	99.87%
6-10 KNOTS	99.88%
11-15 KNOTS	99.88%
16-20 KNOTS	99.88%

Source: National Climatic Data Center NOAA
National Weather Service
San Diego International Airport
San Diego, California - October 6, 2006

Period: 1995-2008

% of VFR Weather = 93%
% of IFR Weather = 6%



LIST OF ABBREVIATIONS

Abbreviation	Description
APL	Aircraft Parking Limit Line
ASOS	Automated Surface Observation System
BRL	Building Restriction Line
CL	Centerline
DME	Distance Measuring Equipment
EMAS	Engineered Material Arresting System
GS	Glide Slope
GPS	Global Positioning System
LS	Instrument Landing System
LOC	Localizer
MALS	Medium Intensity Approach Lighting System
MALS-R	Medium Intensity Approach Lighting System with Runway Alignment Indicator Lights
NM	Middle Marker
NDB	Non-Directional Marker
NPI	Non-Precision Instrument
OFA	Object Free Area
OFZ	Obstacle Free Zone
OM	Outer Marker
PAPI	Precision Approach Path Indicator
PI	Precision Instrument
REL	Runway End Identifying Light
RFL	Runway Protection Zone
RSA	Runway Safety Area
RVR	Runway Visual Range
TW	Taxiway
TBR	To Be Removed
TDZL	Touch Down Zone Lights
S-100	Single Wheel Main Gear 100,000 Pounds Gross Aircraft Weight
D-150	Dual Wheel Main Gear 150,000 Pounds Gross Aircraft Weight
DT-250	Dual Tandem Wheel Main Gear 250,000 Pounds Gross Aircraft Weight
DDT-720	Double Dual Tandem Wheel Main Gear 720,000 Pounds Gross Aircraft Weight

LEGEND

BOUNDARY FENCE	CHAIN LINK	WOODEN
PROPERTY LINE		
STORM INLET		
WATER WOODRANT		
RUNWAY LIGHT		
RUNWAY THRESHOLD LIGHT		
THRESHOLD BAR		
TERMINAL BUILDING		
FIELD STRUCTURE		
APRON AREA		
PAVED RUNWAY OVAL		
CALIFORNIA LEAST TURN WARNING PROTECTION AREA		
MALS AND MALS-R		
REL		
RUNWAY DISTANCE REMAINING SIGN		
OBJECT FREE AREA		
OBSTACLE FREE ZONE		
RUNWAY SAFETY AREA		
BUILDING RESTRICTION LINE		
CENTRAL ELEVATION		
WINDSOCK		
LIGHTED WINDSOCK		
AIRPORT REFERENCE POINT		
AIRPORT SURFACE DETECTION SYSTEM (ASDE REFLECTORS)		
FUTURE DEVELOPMENT		
SURVEY MONUMENTS		

AIRPORT FACILITIES INDEX

Building Number	Building Elevation
Terminal One	1 48'
Terminal Two (Planeside Bridges to be Demolished)	2 3'
Commuter Terminal	3 85'
Air Cargo Building	4 57'
Air Cargo Building	5 41'
Air Cargo Building	6 41'
Post Used	7 N/A
Fuel Dispensing Facility	8 N/A
Fixed Base Operator (To be Demolished)	9 57'
Fixed Base Operator (To be Demolished)	10 58'
Airline Support	11 45'
Airline Support	12 47'
S.D.C.R.A. General Services	13 28'
S.D.C.R.A. Shipping and Receiving	14 47'
S.D.C.R.A. Maintenance Shop	15 38'
FAA Communications	16 44'
San Diego County Regional Airport Authority	17 30'
U.S.O. (To be Reallocated)	18 47'
Airport Traffic Control Building and Tower	19 311.52'
ARFF Station	20 35'
San Diego County Regional Airport Authority	21 65'
Electric Vault & Emergency Generator	22 N/A
Airport Rolling Beacon	23 N/A
Fuel Storage Tanks	24 46'
FAA Communications	25 22'
Airport Facilities Building	26 30'
Electrical Utility Area	27 N/A
Former U.S. Post Office Building (To be Demolished)	28 11'
Waste Disposal Building	29 30'

RUNWAY DATA

	RUNWAY 9	RUNWAY 27
EFFECTIVE RUNWAY GRADIENT	0.02%	0.02%
PERCENT CROSSWIND COVERAGE-15 MPH	88.2%	88.2%
INSTRUMENT RUNWAY	LS-CAT 1	LOCALIZER
RUNWAY LIGHTING	HRL, CL & TDZ	HRL, CL & TDZ
RUNWAY MARKING	PRECISION INSTR.	PRECISION INSTR.
NAVIGATION AIDS	LOC, CAT, MALS, MALSR, OME, OPS	MALS, TR, OME, RWY, OPS, NDB
RUNWAY MAX ELEVATION (ABOVE NAVD 83)	18.87'	18.87'
LENGTH OF EXISTING RUNWAY	3,007'	3,007'
WIDTH OF EXISTING RUNWAY	150'	150'
RUNWAY SURFACE MATERIAL	Asphalt	Asphalt
TAXIWAY SURFACE MATERIAL	Asphalt	Asphalt
PAVEMENT STRENGTH (IN THOUSAND LBS)	S-100, D-150, DT-250, DDT-720	S-100, D-150, DT-250, DDT-720
VISUAL AIDS EXISTING AND PLANNED	MALS, TDZ, PAPI	MALS, TDZ, PAPI
ISA DIMENSIONS	500' x 1,000'	500' x 1,000'
FAA PART 77	II	II
SHOULDER PAVING: RUNWAY = 50'; TAXIWAY = 25'	ALL TAXIWAYS ARE 75' WIDE MINIMUM UNLESS OTHERWISE NOTED	
APPROACH SURFACES:		
RW 9	34:1 FOR 15,000' FLARING UNIFORMLY FROM 1,000' WIDE STARTING AT 200' WEST OF DECEASED THRESHOLD TO 4,000' WIDE AT END	
RW 27	35:1 FOR 15,000' FLARING UNIFORMLY FROM 1,000' WIDE STARTING AT 200' EAST OF DECEASED THRESHOLD TO 4,000' WIDE AT END	

- NOTES:**
- LATITUDE/LONGITUDE IDENTIFIERS ARE IN NAD 83.
 - RUNWAY CENTERLINE LIGHTS AT 50 FT. INTERVAL FROM 50' TO 100' FROM THRESHOLD.
 - TOUCHDOWN ZONE LIGHTS AT 100 FT. INTERVAL FROM 50' TO 100' FROM THRESHOLD.
 - NEAREST SECTION CORNERS ARE LOCATED OFF DRAWING.
 - THE ELEVATIONS SHOWN ON THIS DRAWING ARE BASED ON NORTH AMERICAN VERTICAL DATUM - 1988.
 - BECAUSE OF EXISTING PHYSICAL AND MAN-MADE CONSTRAINTS, EXTENSION OF THE RSA, OFZ AND OFA TO THE EAST OF THE RUNWAY END IS IMPRACTICAL, AND SO THESE ARE NON-EXTENDED.
 - RUNWAY LENGTH DETERMINED BY NATIONAL GEODETIC SURVEY ON 10/10/04.
 - ALL TAXIWAYS ARE 75' WIDE UNLESS OTHERWISE NOTED.
 - NO ON AIRPORT THRESHOLD SITING PENETRATIONS.

FOR ADDITIONAL RUNWAY AND TAXIWAY DATA TABLE - SEE SHEET 2

PROPOSED DECLARED DISTANCE

	TORA	TODA	ASDA	LDA
RUNWAY 9	9,420'	9,420'	8,280'	7,588'
RUNWAY 27	9,420'	9,420'	8,280'	7,591'

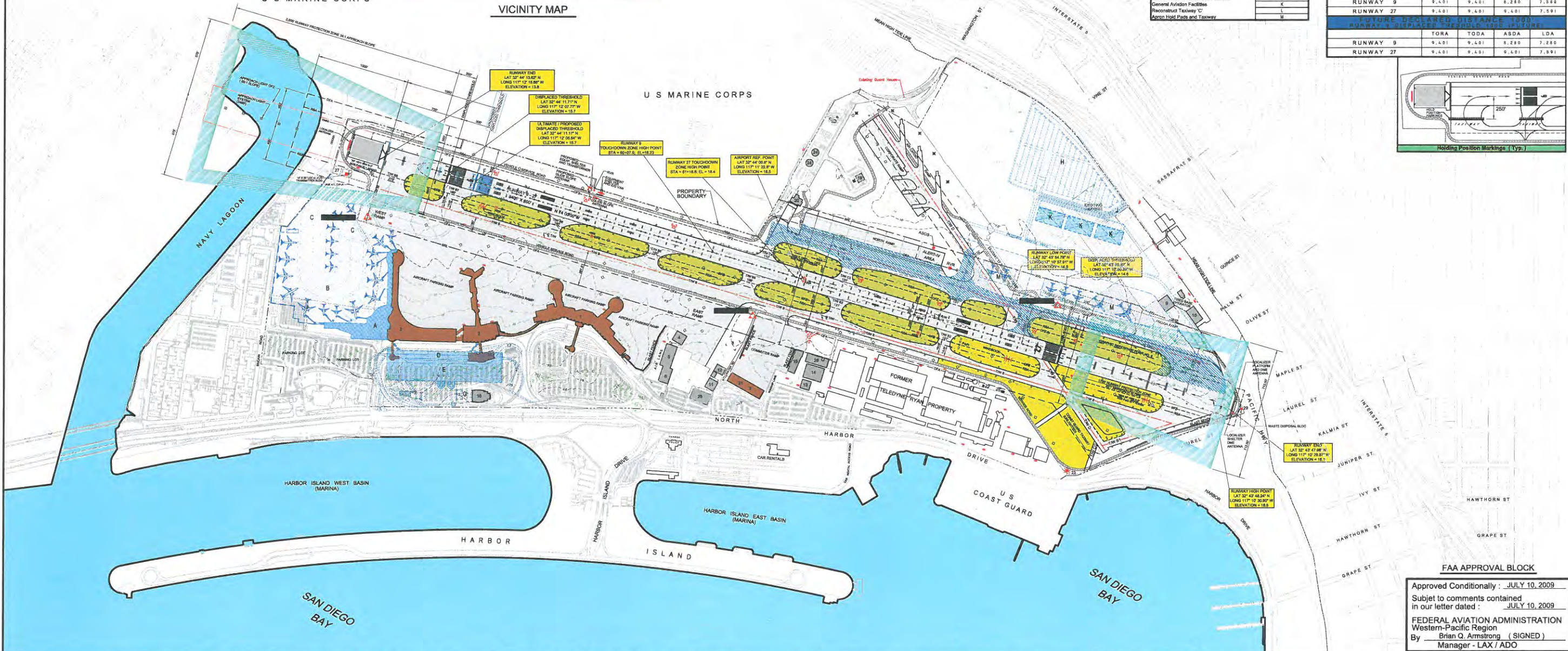
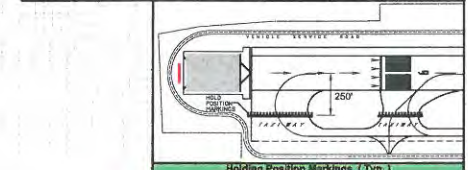

THE CONTENTS OF THIS PLAN DO NOT NECESSARILY REFLECT THE OFFICIAL VIEWS OR POLICY OF THE F.A.A. ACCEPTANCE OF THIS DOCUMENT BY THE F.A.A. DOES NOT IN ANY WAY CONSTITUTE A COMMITMENT ON THE PART OF THE UNITED STATES TO PARTICIPATE IN ANY DEVELOPMENT DEPICTED HEREIN NOR DOES IT INDICATE THAT THE PROPOSED DEVELOPMENT IS ENVIRONMENTALLY ACCEPTABLE IN ACCORDANCE WITH APPROPRIATE PUBLIC LAWS.

REVISIONS

NO.	DATE	DESCRIPTION
1	7/10/09	INCLUDES THE INSTITUTION OF 'DECLARED DISTANCES'
2	9/04/08	F.A.A. REVALIDATED A.L.P.
3	6/05/03	TAXIWAY 'C' DEVELOPMENT GRANT - FISCAL YEAR 2008
4	6/05/03	REVALIDATION DUE TO CHANGES IN THE CURRENT INSTITUTION OF THE REGIONAL AIRPORT AUTHORITY, WITH MINOR DRAWING MODIFICATIONS
5	11/29/01	F.A.A. REVALIDATED A.L.P.
6		MASTER PLAN UPDATE PREFERRED ALTERNATIVE MODIFICATIONS
7		F.A.A. APPROVED A.L.P.



SAN DIEGO INTERNATIONAL AIRPORT
SAN DIEGO COUNTY REGIONAL AIRPORT AUTHORITY

APPROVAL RECOMMENDED:
Henry Peters (SIGNED)
MANAGER, TECHNICAL SERVICES

APPROVED:
Iraj Ghaemi (SIGNED)
DIR. OF FACILITIES DEVELOPMENT DEPARTMENT

SAN DIEGO INTERNATIONAL AIRPORT

AIRPORT LAYOUT PLAN

SAN DIEGO, CALIFORNIA

DATE: June 26, 2009
SHEET 1 OF 2
DRAWING NO. 724

FAA APPROVAL BLOCK

Approved Conditionally: JULY 10, 2009
Subject to comments contained in our letter dated: JULY 10, 2009

FEDERAL AVIATION ADMINISTRATION
Western-Pacific Region
By: Brian Q. Armstrong (SIGNED)
Manager - LAX/ADO

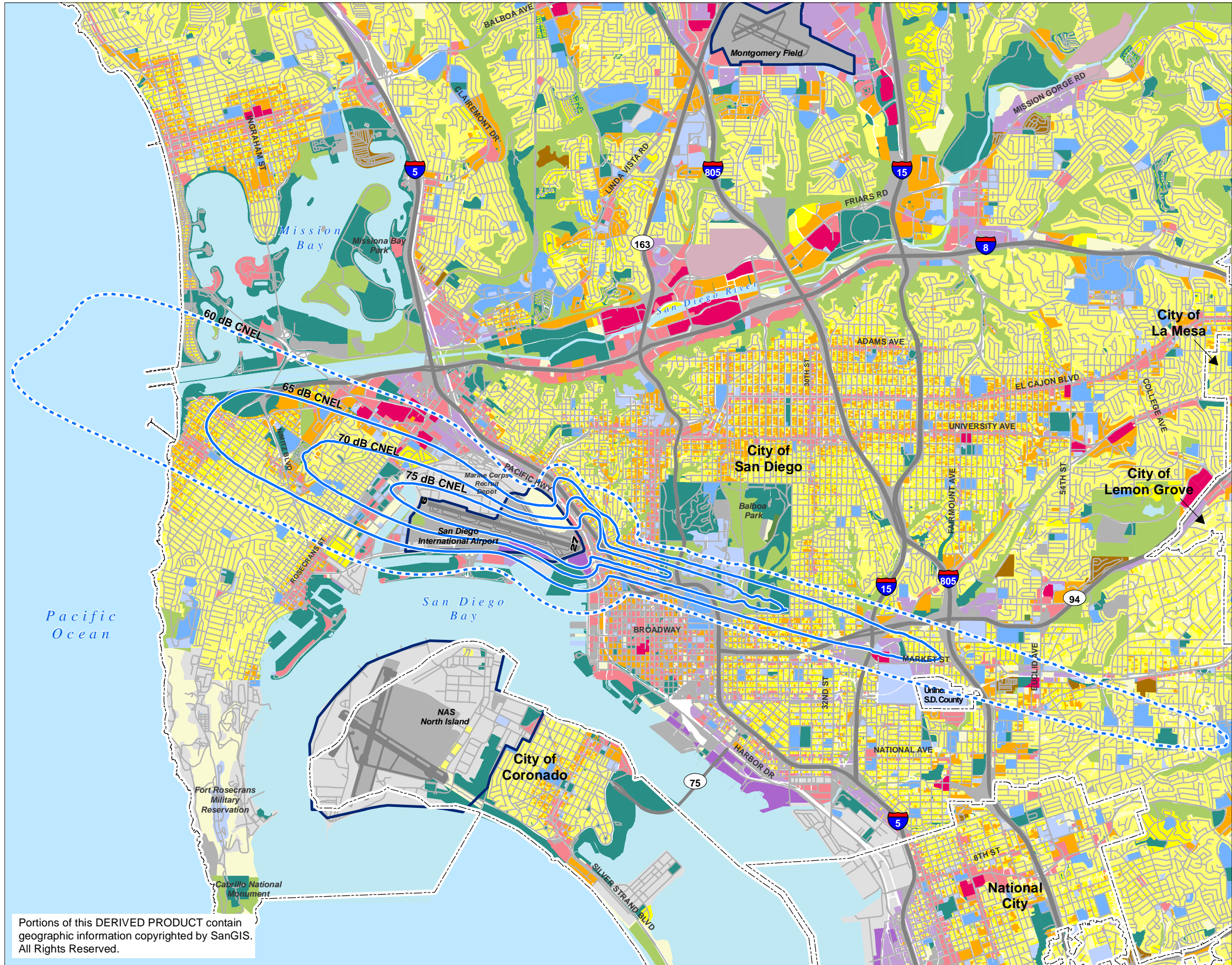

LEGEND

- Major Roads
- Highways
- - - Municipal Boundaries
- ▭ Airport Property Boundary
- ▭ CNEL Noise Contours
- ▭ 60 dB CNEL Noise Contour

Existing Land Use

- ▭ Spaced Rural Residential
- ▭ Single Family Detached
- ▭ Single Family Attached
- ▭ Multiple Family
- ▭ Mobile Homes
- ▭ Mixed Use
- ▭ Shopping Centers
- ▭ Commercial and Office
- ▭ Heavy Industry
- ▭ Light Industry
- ▭ Extractive Industry
- ▭ Education
- ▭ Institutions
- ▭ Transportation, Communications, Utilities
- ▭ Military
- ▭ Recreation
- ▭ Intensive Agriculture
- ▭ Open Space Parks
- ▭ Undeveloped
- ▭ Water

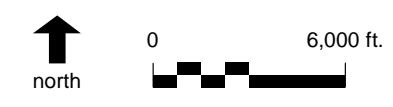

Sources: Noise Contours – HMMH and Ricondo & Associates, 2010; Municipal Boundaries - San Diego Geographic Information Source (SanGIS), 2008; Existing Land Uses - San Diego Association of Governments (SANDAG), 2009; Roads, Highways - San Diego Association of Governments (SANDAG), 2008.

Prepared by: Ricondo & Associates, Inc., November 2010.

Exhibit 2
2030 Forecast
Noise Exposure

Portions of this DERIVED PRODUCT contain geographic information copyrighted by SanGIS. All Rights Reserved.



AIRPORT LAND USE COMMISSION
SAN DIEGO COUNTY

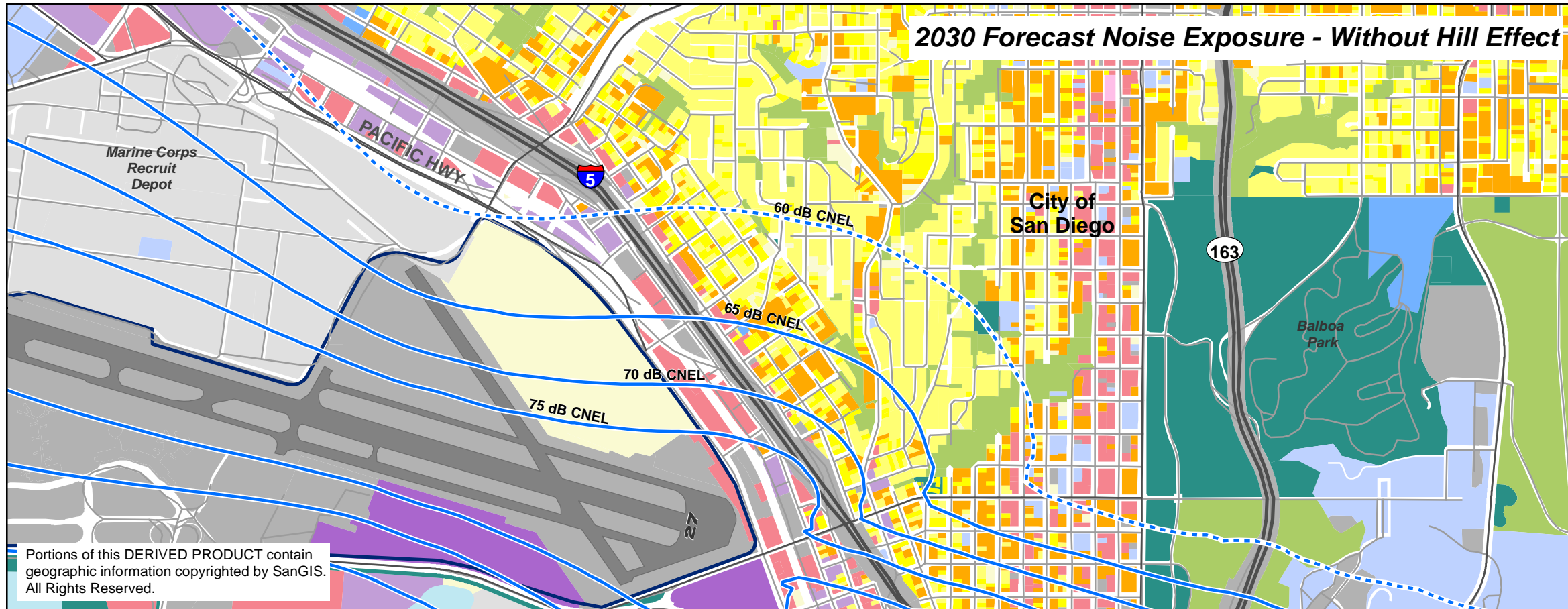
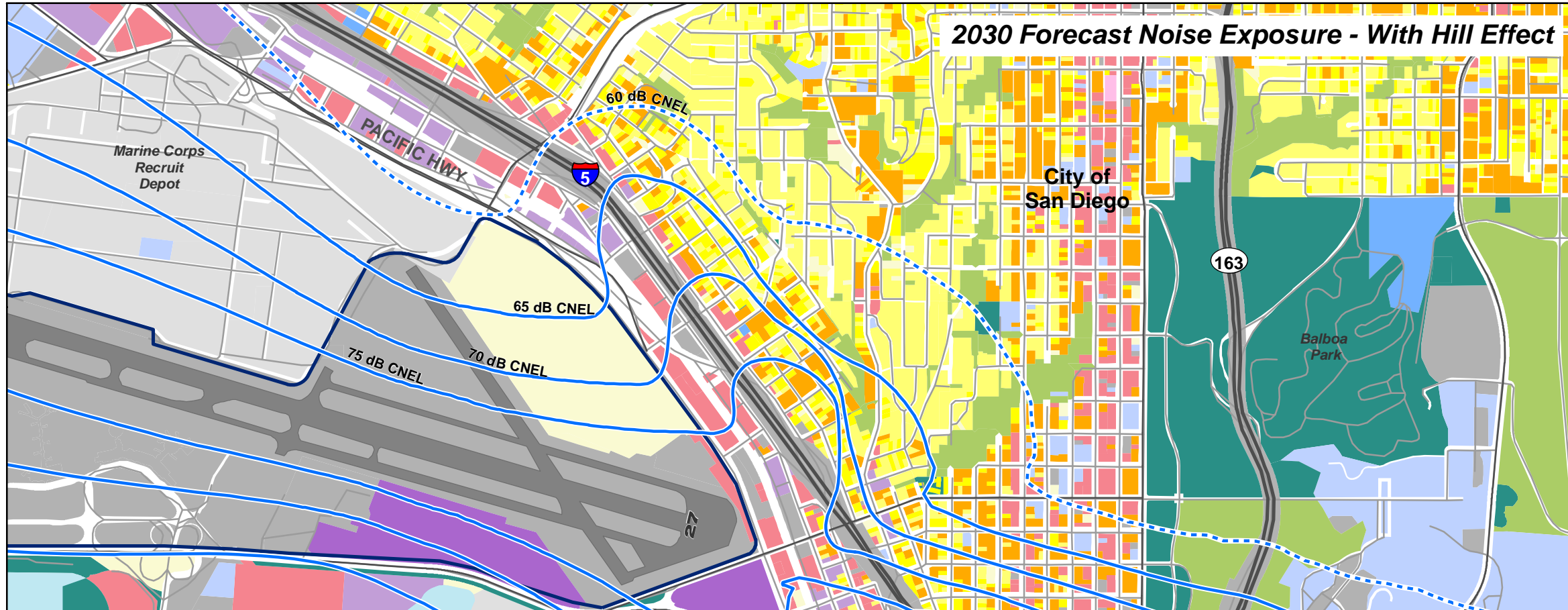

LEGEND

- Major Roads
 - Highways
 - - - Municipal Boundaries
 - ▭ Airport Property Boundary
 - ▭ CNEL Noise Contour
 - ▭ 60 dB CNEL Noise Contour
- Existing Land Use**
- Spaced Rural Residential
 - Single Family Detached
 - Single Family Attached
 - Multiple Family
 - Mobile Homes
 - Mixed Use
 - Shopping Centers
 - Commercial and Office
 - Heavy Industry
 - Light Industry
 - Extractive Industry
 - Education
 - Institutions
 - Transportation, Communications, Utilities
 - Military
 - Recreation
 - Intensive Agriculture
 - Open Space Parks
 - Undeveloped
 - Water

DRAFT CONSULTANT WORK PRODUCT.
FOR DISCUSSION PURPOSES ONLY.



Sources: Noise Contours – HMMH and Ricondo & Associates, 2009; Municipal Boundaries - San Diego Geographic Information Source (SanGIS), 2008; Existing Land Uses - San Diego Association of Governments (SANDAG), 2009; Roads, Highways - San Diego Association of Governments (SANDAG), 2008.

Prepared by: Ricondo & Associates, Inc., September 2010.

Portions of this DERIVED PRODUCT contain geographic information copyrighted by SanGIS. All Rights Reserved.

Exhibit 5-5.1
2030 Forecast
Noise Exposure -
With and Without Hill Effect

APPENDIX G SUPPLEMENTAL NOISE MEASUREMENT PROGRAM TO DETERMINE HILL EFFECTS

The Airport Authority quarterly adjusts its modeled CNEL contours to better reflect the measured values up on the hill behind the start of takeoff as required by Title 21 to determine the extents of the 65 dB CNEL contour. A 3 to 5 dB difference in measured versus modeled has occurred consistently for years and the noise monitors have been shown to accurately measure aircraft noise at these locations. Therefore, the Airport Authority directed HMMH to conduct a supplemental noise measurement program with the Part 150 update to: (1) determine whether the hill effect exists; (2) determine a repeatable and defensible process to accurately adjust the CNEL contours in this area to account for the hill effect; and (3) obtain FAA approval of the process and the resulting CNEL contours.

To investigate and derive a means to account for the possible hill effect in the noise contouring process, HMMH conducted a supplemental noise measurement program in the airport's environs from January 28, 2008 through February 4, 2008 in accordance with Part 150 guidelines. The noise measurement program attempted to determine and quantify the potential significance of terrain-related sound propagation in the area to the north-northeast of Runway 27, which includes rising terrain from the Airport.

Noise measurement program objectives

The supplemental noise measurement program had two principle objectives:

1. To obtain representative information on aircraft single-event noise levels at six sites located at various residences on the hill and at a "reference" site at the base of the hill. The SENEL is an important metric as it is the foundation for computing the CNEL.
2. To compare predicted values from the FAA Integrated Noise Model Version 7.0 (INM 7.0) with the measured values to determine the effect of the hill on noise exposure levels not currently modeled in the INM. Any differences are documented in the submittal to the FAA to obtain approval for making adjustments to the modeling results when developing the noise exposure maps (NEMs, Appendices A and B).

To accomplish these objectives, noise measurements were conducted at six temporary locations. At all six locations, the measurements covered at least seven continuous complete days. A noise consultant staff member was stationed at each measurement location for several hours during the measurements to observe and record noise-producing activity with primary emphasis on the morning departure "push" between 6:30 am and 10:00 am.

Noise measurement site selection

The monitoring locations were selected based on consultant and Airport Authority staff suggestions prior to installing the portable noise monitors on January 28, 2008. Selection criteria included the following major factors:

- Line-of-sight to the start of takeoff for Runway 27
- Measurement of the noise exposure levels at the base of the hill and at various distances up the rising terrain
- Use of the permanent noise monitors on the hill to complement portable measurement positions
- Security and accessibility of equipment

Table G1 lists the portable and permanent noise monitor measurement locations, the dates and times of measurements, the number of hours of monitoring, and the number of hours of observations. The locations at which portable noise monitoring was conducted for this study are presented in Figure G-1.

Table G1 Summary of Noise Measurement Sites

Source: HMMH and Airport Authority (RMT data), January/February 2008 Noise Measurement Program

Site	Address	Start		End		Hours Monitored	Hours Observed
		Date	Time	Date	Time		
1	1020 W. Redwood St.	1/28/2008	11:45 am	2/4/2008	10:36 am	166	7.0
2	921 W. Palm St.	1/28/2008	1:46 pm	2/4/2008	12:00 pm	166	5.0
3	2776 State St.	1/28/2008	2:20 pm	2/4/2008	11:02 am	166	4.5
4	2827 Columbia St.	1/28/2008	2:49 pm	2/4/2008	11:21 am	166	4.0
5	1411 W. Palm St.	1/28/2008	1:10 pm	2/4/2008	10:16 am	166	3.5
6	3045 Columbia St.	1/28/2008	1:01 pm	2/4/2008	11:37 am	166	4.0
RMT 9	1134 ½ W. Redwood St.	Continuous 24/7 monitoring					
RMT 19	1290 ½ W. Thorn St.	Continuous 24/7 monitoring					



Supplemental Measurement Locations

Figure G-1

- | | | | | |
|--|-----------------------------|-----------------------------|-----------------------------|----------------------|
| Supplemental Measurement Locations | Airport Property | Roads | River / Stream | SAN Airport Runways |
| Single Family Residential | Airport Property | Golf Courses | Public Service | Schools |
| Multi-Family Residential | Mobile Home Parks | Industrial | Agriculture | Parks |
| Mobile Home Parks | Hotel/Motel, Group Quarters | Land Under Construction | Vacant and Undeveloped Land | Water |
| Commercial | Industrial | Parks | Water | Hospital |
| Transportation/Communication/Utilities | Land Under Construction | Vacant and Undeveloped Land | Water | Schools |
| Land Under Construction | Parks | Water | Water | Place of Worship |
| Vacant and Undeveloped Land | Water | Water | Water | Library |
| Water | Water | Water | Water | College / University |

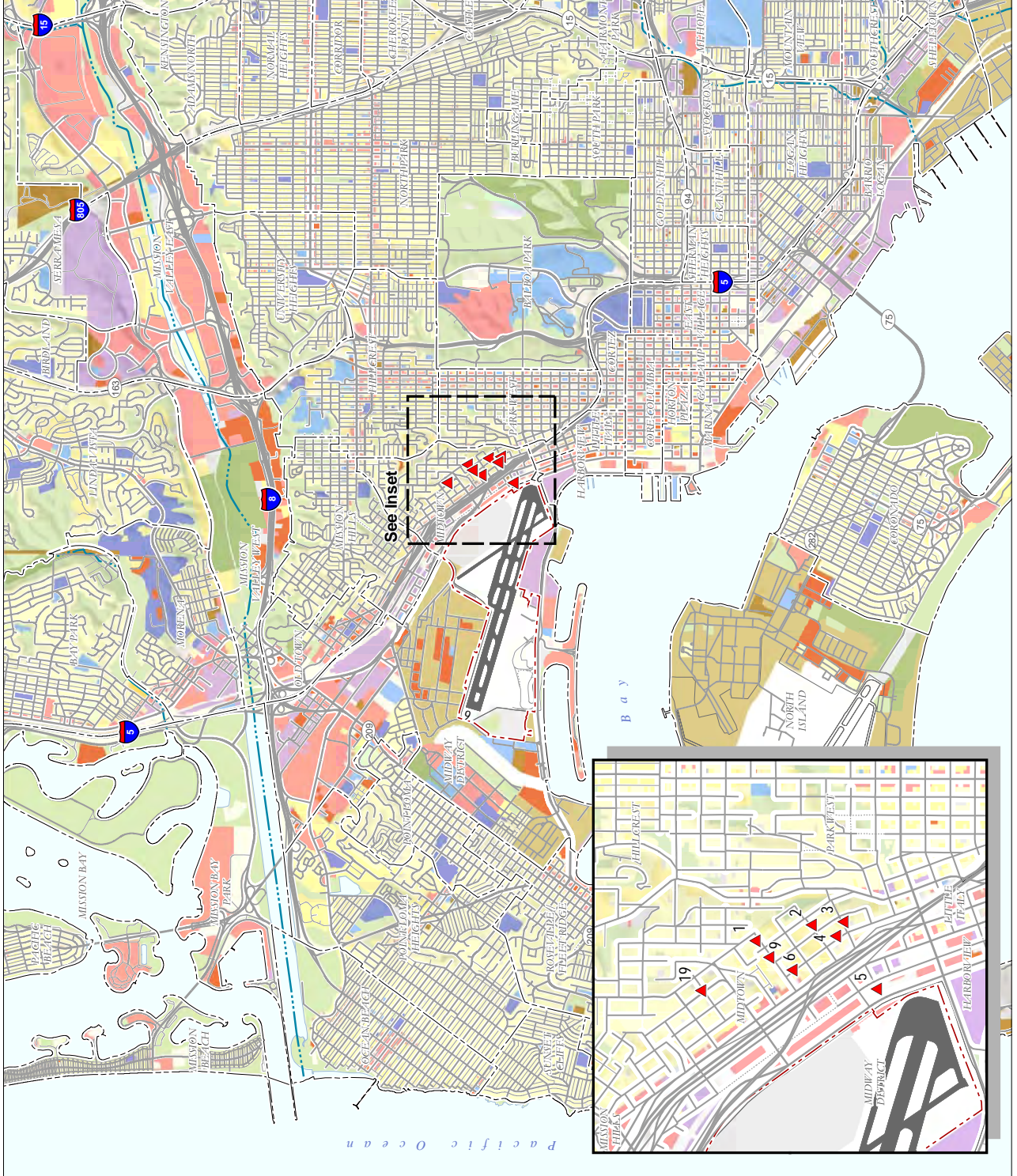

Data Sources: San Diego International Airport; San Diego Association of Governments (SANDAG); City of San Diego and County of San Diego (SanGIS); Environmental Systems Research Institute, Inc. (ESRI).



This page intentionally left blank

Noise measurement instrumentation, staffing, and procedures

Measurements were conducted with Larson-Davis Model 870 (“LD 870”) noise monitors. This model meets the American National Standards Institute (ANSI) S1.4-1983 standards for a Type I “precision” sound level meter, and meets or exceeds accuracy requirements defined in Part 150 paragraph A150.5. The consultant staff calibrated the equipment in the field on a daily basis. The calibrations are traceable to the United States National Institute of Standards and Technology (NIST).

The LD 870’s were programmed to record cumulative levels, such as L_{eq} and CNEL, and single-event levels, such as L_{max} and SENEL. Appendix B introduces these metrics and discusses all measurements being A-weighted.

The units operated on a 24-hour basis during the seven-day measurement session, with breaks for battery changes, calibration, and basic maintenance requirements. Two consultant staff members conducted the observations and monitored the measurements. The staff spent time at the monitoring locations to observe and log aircraft and non-aircraft noise-producing events, weather data, and other relevant information.

The portable monitors’ clocks were synchronized to local time using the NIST clock in Boulder, Colorado to facilitate the correlation of aircraft noise events measured at multiple sites.

Noise Measurement Results

The primary purpose of the noise measurement program was to determine the effects of the hill behind the start-of-takeoff for Runway 27 on the overall aircraft noise exposure. Due to the unobstructed line-of-sight to the runway and noise source due to the higher elevation, the associated sound propagation path is elevated above the ground (path 3 below) resulting in reduced or no expected sound attenuation due to ground absorption. The INM predicts the noise levels assuming the sound propagation path follows the ground and appropriately reduces the levels due to ground attenuation of the sound over that path (path 2 below). As shown through a similar study at Boston’s Logan International Airport, these topological conditions cause the INM to under-predict the sound levels experienced by those residences on the hill facing the airport.

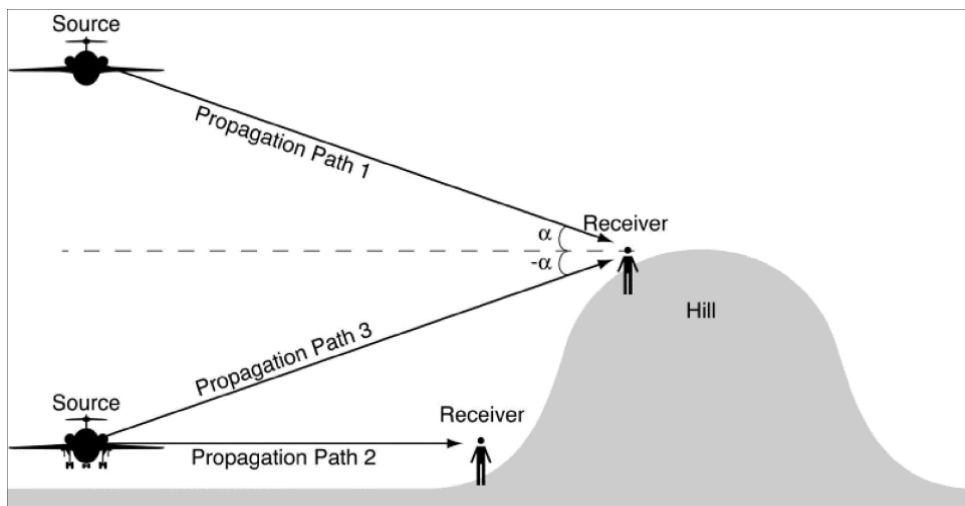

Figure G-2 Aircraft Noise Propagation Paths to Receivers on a Hill
Source: HMMH

In an attempt to improve the noise modeling results from INM 7.0, the noise monitors placed on the hill measured the noise associated with actual aircraft departures, using the Single Event Noise Exposure Level or SENEL. The measured noise events were correlated with the actual aircraft operations, the average SENEL for each site and aircraft type derived, and the averages compared to the INM modeled SENEL results for the same aircraft operations. Each correlated flight track was modeled using RealContours to preprocess the operation for the INM.

Figure G-3 shows the supplemental measurement sites at SAN behind the start-of-takeoff point with their respective elevations and distances from the runway. As shown, some sites were expected to be subject to a similar propagation path as Propagation Path 3 in Figure G-2. Other sites (such as Site 1) were at or just beyond the leveling of the top of the hill and therefore expected to experience a propagation path more similar to Propagation Path 2 with some ground attenuation. The measurement results provided some supporting evidence to these phenomena.

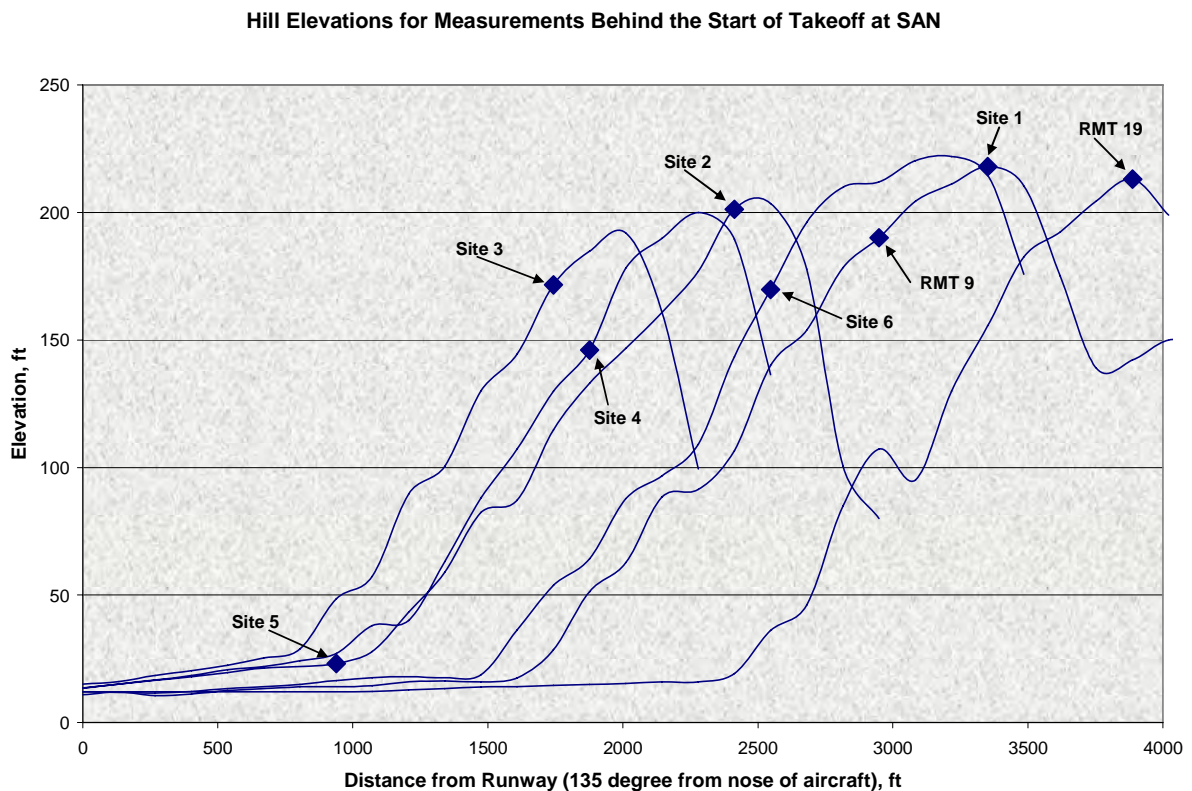

Figure G-3 Location of Measurement Sites on Hill Relative to Start-of-Takeoff roll – RWY 27
 Source: HMMH

Table G2 summarizes the differences between the average measured and average modeled SENEL values for six major aircraft types operating at SAN. The general under-prediction (1 to 11 dB) by the model indicates there is less sound attenuation based on aircraft takeoff noise due to the elevation of the sites and that *there is a “hill effect”* on the noise contours in this region as experienced at other airports like Boston’s Logan International Airport. Site 5, which had very little difference, is at the base of the hill and therefore would not be subject to any hill effects.

Table G2 Comparison of Average SENEL Differences – Hill Effects

Source: HMMH and Airport Authority, January/February 2008 Noise Measurement Program

Aircraft Type	Difference in Average SENEL Values at Measurement Sites (Measured - Modeled) (dB)							
	1	2	3	4	(base)	6	MT9 R	T19 RM
MD80	3.3	9.2	15.1	12.0	4.0	11.2	10.3	9.7
B737700	-1.9	2.4	9.5	7.3	-2.0	7.2	6.4	4.3
A320	4.9	8.8	12.4	12.5	-1.2	11.8	11.6	10.4
B757	-0.1	4.9	10.3	10.2	0.2	8.2	7.8	7.0
737300	2.2	6.3	11.2	10.1	0.2	9.3	0.2	7.7
SF34	-0.5	1.7	9.4	5.6	-2.7	6.4	5.2	3.2
Avg	1.3	5.6	11.3	9.6	-0.3	9.0	6.9	7.1

Note: A positive difference means under-prediction by the INM and a negative means over-prediction.

Since the FAA Office of Environment and Energy (AEE) is the approval authority for all user changes to the INM and based on the results of the supplemental noise measurements’ analysis, a correction for the INM modeling on the hill behind the start of takeoff was submitted to the FAA for use in this study (NEMs, Appendices A and B). After an in-depth review, the FAA did not accept the methodology for determining the appropriate adjustments to the INM and therefore, the adjustment for hill effects was not applied in the modeling process (Appendix H). In the FAA letter of response to the NEMs modeling request, the FAA provided an option that stated:

“The observed noise levels along the hillside could be shown in a separate supplemental analysis. In this analysis, SAN will need to show that observed CNEL values along the hillside may be greater than the modeled CNEL values due to the position of the aircraft with respect to the hill. As a result, supplemental qualitative or quantitative information may be used to account for the effect. During the Noise Compatibility Program (NCP) review process the FAA would take into consideration the eligibility of mitigation for those homes identified as a result of the limitations in modeling lateral attenuation along the hillside.” (Appendix H)



U.S. Department
of Transportation
**Federal Aviation
Administration**

Western-Pacific Region
Los Angeles Airports District Office

Federal Aviation Administration
P.O. Box 92007
Los Angeles, CA 90009-2007

November 20, 2008

Mr. Dan Frazee
Director, Airport Noise Mitigation
San Diego County Regional Airport Authority
San Diego International Airport
P.O. Box 82776
San Diego, CA 92101

**San Diego International Airport Part 150
Noise Exposure Map Modeling**

Dear Mr. Frazee:

I am in receipt of your October 24, 2008, e-mail, requesting that a number of questions be answered regarding the status of the Part 150 Study Update currently being implemented at San Diego International Airport. During our October 27, 2008, conference call I indicated that I would provide you a response in writing to address your questions and concerns (highlighted in bold) after conferring with my colleagues and other lines of business in the Federal Aviation Administration.

1. Last week Airport Authority Quieter Home Program staff and our 14 CFR Part 150 contactor personnel (HMMH) attended the AAAE where an FAA representative presented the progress to an update AC for 14 CFR Part 150. HMMH noted and brought to my attention that the FAA recommends (in a future AC update) that the latest version of the Integrated Noise Model (INM) be used up to the point that the Noise Exposure Maps (NEM) is "released to the public."

I spoke with Dean McMath, FAA's Southwest Region, Regional Environmental Team Leader who was the speaker at the AAAE Aircraft Noise Mitigation Symposium in San Antonio, TX. Mr. McMath indicated that the FAA does recommend that the latest version of the Integrated Noise Model be used prior to release of the Noise Exposure Maps. If an airport sponsor initiates a Part 150 using a particular version of the INM and the INM is updated during the process, the sponsor can continue using the original model throughout the study. This Advisory Circular update does not change this process.

2. HMMH has also notified the Authority that FAA discovered inaccuracies in INM 7.0, which were corrected in version 7.0a.

The consultant was correct. As with other major software changes and updates, there are minor "bugs" that are routinely addressed and corrected to make the program better. This is the first change made to INM 7.0 since its release in April 2007. Be aware that INM 6.0 was released in 1999 and was modified six times prior to the release of INM 7.0. This change to INM 7.0 is identified with the following language on the FAA website:

"Corrections

INM Version 7.0a corrects minor issues related to differences between runway end and airport elevations, behind start of takeoff roll directivity, version conversion for metric INM studies, and the handling of reference speeds for helicopter Noise Power Distance (NPD) curves. These and other corrections are further clarified in the INM 7.0a Release Notes."

3. How does this affect SAN's 14 CFR Part 150 update, which is currently in the works? Specifically, is it FAA's intent to mandate that SAN revise the 2008/2013 NEM using INM 7.0a (we have already begun the process using INM 7.0 and produced a draft NEM, but held it at your request in June 2008)? If we are to revise with INM 7.0a, it is likely we will not submit the NEM to the FAA until early 2009. As a result, will the NEM be required to include 2009 as the base year and 2014 as the forecast year?

The SAN Part 150 Update may be affected depending on the course of action that the SDCRAA chooses to take. At this point in the Part 150 Study the FAA is not ready to mandate that the SDCRAA use INM 7.0a. On June 18, 2008, I received an email from Bob Behr at HMMH indicating that: "Attached is our letter requesting FAA review and approval of certain INM substitutions and adjustments for hill effects and approach angle. The draft NEM will be posted on the SAN website, probably tomorrow." In an immediate follow-up e-mail from Dave Kessler at the FAA to the SDCRAA, the FAA provided the following reasons for not releasing the Part 150 NEM's. 1) "... the process to prepare the NEM's for San Diego International Airport (SAN) have not been followed" and 2) "In the event the proposed substitutions are disapproved, the SDCRAA would have to prepare new NEM's and then republish them for public review and have another public meeting/hearing causing additional costs to the sponsor that are not necessary if the proper procedure is followed."

In the future, requests for FAA approval for nonstandard inputs into INM must be completed and responded to before NEMs are released. It is in the best interest of SDCRAA to wait for a response before starting the analysis since no approval is guaranteed. The SDCRAA has a number of options to consider with preparation of its Part 150 Study Update NEMs:

1) Re-run the 2008 and 2013 forecasts using INM 7.0 and only include the proposed aircraft substitution and 3.5 degree glideslope angle, which AEE has reviewed and approved¹. The observed noise levels along the hillside could be shown in a separate supplemental analysis. In this analysis, SAN will need to show that observed CNEL values along the hillside may be greater than the modeled CNEL values due to the position of the aircraft with respect to the hill. As a result, supplemental qualitative or quantitative information may be used to account for the effect. During the Noise Compatibility Program (NCP)

¹ AEE reviewed the proposed lateral attenuation adjustment for the hill as well. Although AEE understood the need to remove some lateral attenuation adjustment (LA_adj) in INM when elevation angle becomes negative, it did not agree on the technical merits of the proposed method. AEE is available to discuss this further if you would like. Removing LA_adj is highly dependent on local situations and additional factors, some of which are still under research.

review process the FAA would take into consideration the eligibility of mitigation for those homes identified as a result of the limitations in modeling lateral attenuation along the hillside.

2) If SAN insists on supplementing the lateral attenuation modeling within INM then AEE requests a different methodology for modeling the effects. The enhanced method needs to be sent to AEE for review. Again, there is no guarantee that AEE will approve the model change or be able to recommend an alternative at the end of the coordination. In the event that SAN chooses to delay the NEM process, and the CNEL contour has not decreased by 1.5 dB or greater over noncompatible land uses, the FAA can accept the 2008 existing conditions NEM documentation, as representative of existing conditions at SAN. If forecast operations for at least five years beyond 2008 (2013) will not produce a CNEL 1.5 dB increase or decrease over noncompatible land uses at SAN, we can accept your forecast year NEM as representing 2013. You will need to provide certification in a letter to us (§150.21(d)(4)(e) "Each map, or revised map, and description of consultation and opportunity for public comment, submitted to the FAA, must be certified as true and complete under penalty of 18 U.S.C. 1001.") providing factual statements to this effect once you have completed a review of the SAN Part 150 existing and forecast operations data.

4) Is the Authority eligible for a grant increase (it would be less than 15% of the current grant) to cover these costs associated with additional work not scoped in the original study update contract?

Planning grants are not subject to being amended. Section 27 (d) of FAA Order 5100.38C Airport Improvement Program Handbook states that "The United States maximum obligation separated under a planning grant or such elements with the project cost separately itemized in any grants cannot be increased even when the scope of work changes." The 15% reference to grant amendments is applicable to construction grants not planning grants. Therefore, the Authority would not be eligible for reimbursement of additional costs incurred associated with the Part 150 Study Update.

We look forward to completing this project in a timely manner. If you have any additional questions, please feel free to call me at 310-725-3637.

Sincerely,



Victor Globa
Environmental Protection Specialist

cc: Brian Armstrong, LAX-600
Victoria Catlett, APP-400
Bill He, AEE-100
Dave Kessler, AWP-610

DEPARTMENT OF TRANSPORTATION

DIVISION OF AERONAUTICS

P.O. BOX 942874, MS-40

SACRAMENTO, CA 94274-0001

PHONE (916) 654-4959

FAX (916) 653-9531

TTY 711

www.dot.ca.gov



*Flex your power!
Be energy efficient!*

File: San Diego ALUC

April 4, 2013

Ms. Angela Jamison
Airport Planning Manager
San Diego County Regional Airport Authority
P.O. Box 82776
San Diego, CA 92138-2776

Dear Ms. Jamison:

On March 13, 2013, the California Department of Transportation, Division of Aeronautics received your letter requesting the review and acceptance of the updated San Diego International Airport (SDIA) Airport Layout Plan (ALP), which was approved by the Federal Aviation Administration (FAA) on October 22, 2012. Currently, the Airport Land Use Compatibility Plan (ALUCP) for the SDIA is being updated, and per Public Utilities Code section 21675(a), the ALUCP must be based on the most recent ALP.

Per your findings, the updated ALP has no effect on the draft ALUCP, as it proposes no changes to the runway, runway thresholds, or runway protection zones. Although the updated ALP may not have an effect on the ALUCP, the proposed consolidated rental car facility and parking lot should be analyzed for compatibility and consistency with the updated ALUCP. Additionally, this construction project will require submission of FAA Form 7460-1 for obstruction evaluation. The approved ALP and draft ALUCP document must be consistent with one another.

This letter serves as the Division of Aeronautics review and acceptance of the submitted SDIA ALP, as approved by the FAA, for the inclusion into the draft ALUCP. Please note that any proposed changes must be reviewed and approved by the Division of Aeronautics to ensure the State's participation. If you have any questions, please contact me at (916) 654-7075 or by email at ron_bolyard@dot.ca.gov.

Sincerely,

Original signed by:

RON BOLYARD, Aviation Planner
Office of Aviation Planning
Division of Aeronautics

bc: Chris Schmidt-Caltrans District 11, Jacob Armstrong-Caltrans District 11



March 13, 2013

VIA E-MAIL

Mr. Terry Barrie
Chief, Office of Aviation Planning
California Department of Transportation
Division of Aeronautics, MS 40
P. O. Box 942874
Sacramento, CA 94274-0001

RE: San Diego International ALUCP – Updated ALP

Dear Mr. Barrie:

As you know, the San Diego County Regional Airport Authority (SDCRAA), acting as the Airport Land Use Commission (ALUC) for San Diego County, has been updating the San Diego International Airport Land Use Compatibility Plan (SDIA ALUCP) for the past two years. The Airport Authority has completed the draft ALUCP document and is initiating the preparation of California Environmental Quality Act (CEQA) documentation. We anticipate certification of the Environmental Impact Report and approval of the final ALUCP late this year.

The FAA approved an updated Airport Layout Plan (ALP) for SDIA on October 22, 2012. The updated ALP has no effect on the draft ALUCP, as it proposes no changes to the runway, the runway thresholds, or the RPZs. The major ALP changes relate to the north airfield, where the Consolidated Rental Car Facility and a large parking lot are planned. Other changes reflect construction completed since the prior ALP was completed and refinements in the planned use of miscellaneous buildings on the airfield.

While the updated ALP has no effect on the draft ALUCP, we still intend to include the updated ALP in the final ALUCP document. With this letter, we request your written approval for the use of the updated ALP in preparing the ALUCP for SDIA, consistent with the requirement of state law that ALUCPs must be based on the latest master plan or airport layout plan (PUC Sec. 21675(a)), as approved by the California Department of Transportation, Division of Aeronautics.

Please address your response to Ms. Angela Jamison with the San Diego County Regional Airport Authority, whose address is provided below, and copy me.

Angela Jamison
Airport Planning Manager
San Diego County Regional Airport Authority
P.O. Box 82776
San Diego, CA 92138-2776



Mr. Terry Barrie
Chief, Office of Airport Planning
March 13, 2013
Page 2

If you have any questions regarding the enclosed information or would like to discuss any of the materials further, please call me at 760-444-0106 Ext. 399, or Angie Jamison at 619-400-2464. Thank you very much for your assistance.

Sincerely,
RICONDO & ASSOCIATES, INC.

A handwritten signature in black ink that reads "Mark R. Johnson". The signature is written in a cursive style with a large, looping "J" at the end.

Mark Johnson, AICP
Director

Enclosures: Airport Layout Plan, Sheets 1 and 2.

cc: Mr. Keith Wilschetz, Director of Planning, San Diego County Regional Airport Authority (with enclosures)
Ms. Angela Jamison, Planning Manager, San Diego County Regional Airport Authority (with enclosures)
Ms. Amy Gonzalez, Director, Counsel Services, San Diego County Regional Airport Authority (with enclosures)

10-14-0696-03-1150
Read File



APPENDIX G

Aircraft Bird Strikes in California

G.1 Overview

Bird and wildlife strikes have concerned aviators since the earliest days of aviation, Orville Wright reported the first bird strike in 1905. Wildlife strikes can damage aircraft and cause serious accidents. The crash of US Airways Flight 1549 on January 15, 2009, the Miracle on the Hudson, was a recent reminder of the threat birds pose to low-flying aircraft. After colliding with a flock of Canada Geese three minutes into the flight, the aircraft lost power in both engines, forcing the pilot to ditch in the Hudson River. Outstanding crew performance, aided by forgiving weather conditions, prevented this frightening accident from becoming worse, all passengers escaped unharmed.¹

On October 4, 1960, Eastern Air Lines Flight 375 had a grimmer ending. The aircraft was struck by a flock of European starlings during take-off, damaging all four engines. That flight ended in tragedy as the aircraft crashed in Boston harbor, killing 62 people – the worst recorded accident involving an aircraft wildlife strike.

The FAA has maintained a wildlife strike database since 1990.² Between 1990 and 2011, the FAA recorded 133,000 wildlife strikes. While 97.5 percent of all strikes involve birds, strikes with other animals such as deer, coyotes, turtles, skunks, and alligators have also been reported. Since the FAA began tracking wildlife strikes, there have been 54 civil aircraft either destroyed or damaged beyond repair.

¹ MSNBC News, January 15, 2009. http://www.msnbc.msn.com/id/28678669/ns/us_news-life/t/ny-jet-crash-called-miracle-hudson/#.UPHiRPLdFJQ (accessed January 17, 2013).

² The information included in this appendix was taken from the following website: Federal Aviation Administration, National Wildlife Strike Database, http://www.faa.gov/airports/airport_safety/wildlife/database/ (accessed January 2, 2013).

Since 1990, there have been 257 injuries and 23 fatalities resulting from wildlife strikes. Damages caused by wildlife strikes average \$123 million per year, but are probably much higher because an estimated 80 percent of strikes are not reported to the FAA.

Most bird strikes occur at relatively low altitudes, with 92 percent occurring at or below 3,500 feet above ground level (AGL). Given these low altitudes, most bird strikes occur near airports. In fact, most occur during the approach and landing roll phases of flight.

In 2011, 53 percent of the birds struck were identified to the species level. Many remains are identified by trained wildlife biologists working at the airports. The FAA has also established a cooperative program with the Smithsonian Institution. The remains of birds are accepted by the Smithsonian's Feather Identification Laboratory. Depending on the condition of the remains, birds can be identified based on physical characteristics, feather fragments, or DNA analysis. Gulls are the most common type of bird to strike aircraft. They account for 17 percent of the birds identified in bird strikes. Doves and pigeons are the second most common, accounting for 15 percent of the birds identified in bird strikes.

G.2 Bird Strikes in California

As part of the technical work supporting the SDIA ALUCP, the consultant undertook a study of bird strikes in California from 2000 through 2012. A total of 6,685 wildlife strikes were reported in California during that period, and 617 strikes (7.2 percent) were reported to have damaged aircraft. Twelve of the incidents causing damage involved deer or coyotes, and one involved cattle. The other incidents were bird strikes.

Table G-1 summarizes the data for bird strikes causing damage to aircraft. Over \$38 million in damage was caused by the bird strikes, an average of \$64,386 per incident. In almost 59 percent of the cases, the species of bird was identified. Ducks were involved in 12.9 percent of the strikes, gulls in 9.8 percent, hawks in 8.3 percent, geese in 7.3 percent, and pigeons and doves in 5.4 percent. The remaining strikes were scattered among a variety of bird species.

Table G-1 Aircraft Bird Strikes Causing Aircraft Damage: Reported Incidents in California, 2000 - 2012

Type of Bird ¹	Number of Each Type	Each Type as Percentage of Total	Cost of Repairs
Coot	3	0.5%	\$470
Cormorant	1	0.2%	\$0
Duck	78	12.9%	\$2,445,480
Falcon, harrier, kite	3	0.5%	\$5,001,500
Goose	44	7.3%	\$4,149,706
Grebe	4	0.7%	\$1,900,000
Gull	59	9.8%	\$3,332,848
Hawk	50	8.3%	\$414,362
Heron, egret, ibis	15	2.5%	\$757,200
Loon	2	0.3%	\$2,220,000
Owl	10	1.7%	\$97,960
Pelican	7	1.2%	\$58,609
Perching bird – large ²	4	0.7%	\$8,150
Perching bird – small ³	19	3.1%	\$96,789
Pigeon, dove	32	5.3%	\$4,397,959
Plover	3	0.5%	\$2,250,000
Turkey	1	0.2%	\$0
Unknown bird – large ⁴	55	9.1%	\$1,595,292
Unknown bird – medium ⁴	145	24.0%	\$9,648,352
Unknown bird – small ⁴	47	7.8%	\$199,779
Unknown bird - unknown size	2	0.3%	\$4,860
Vulture	14	2.3%	\$203,698
Wading bird ⁵	6	1.0%	\$106,347
Totals	604	100.0%	\$38,889,361
Average Repair Cost per Incident			\$64,386

Notes:

- 1 The consultant has grouped the individual species listed in the FAA's database into the broader categories presented in this column.
- 2 Large perching birds include crows and ravens.
- 3 Small perching birds include sparrows, larks, swallows and other birds that nest and roost in trees and other perches.
- 4 Bird size is reported by the person filing the wildlife strike report. There are no firm guidelines for reporting size.
- 5 This category includes medium-sized wading birds such as sandpipers, curlews and dunlins, but not herons, egrets, ibises, and other large waders.
- 6 Twelve other strikes causing aircraft damage, involving deer, coyotes and cattle, were reported during the period.

Source: Ricondo & Associates, Inc., January 2013, based on Federal Aviation Administration National Wildlife Strike Database, http://www.faa.gov/airports/airport_safety/wildlife/database/ (accessed January 2, 2013).

Prepared by: Ricondo & Associates, Inc., January 2013.

